



U.S. Fish & Wildlife Service

Sign Handbook

Signage Policy and Guidance

March 2019

(Amended by Decision Memorandum, "Approval of Revisions to ~350 Directives to Remove Gender-Specific Pronouns," 6/22/2022)

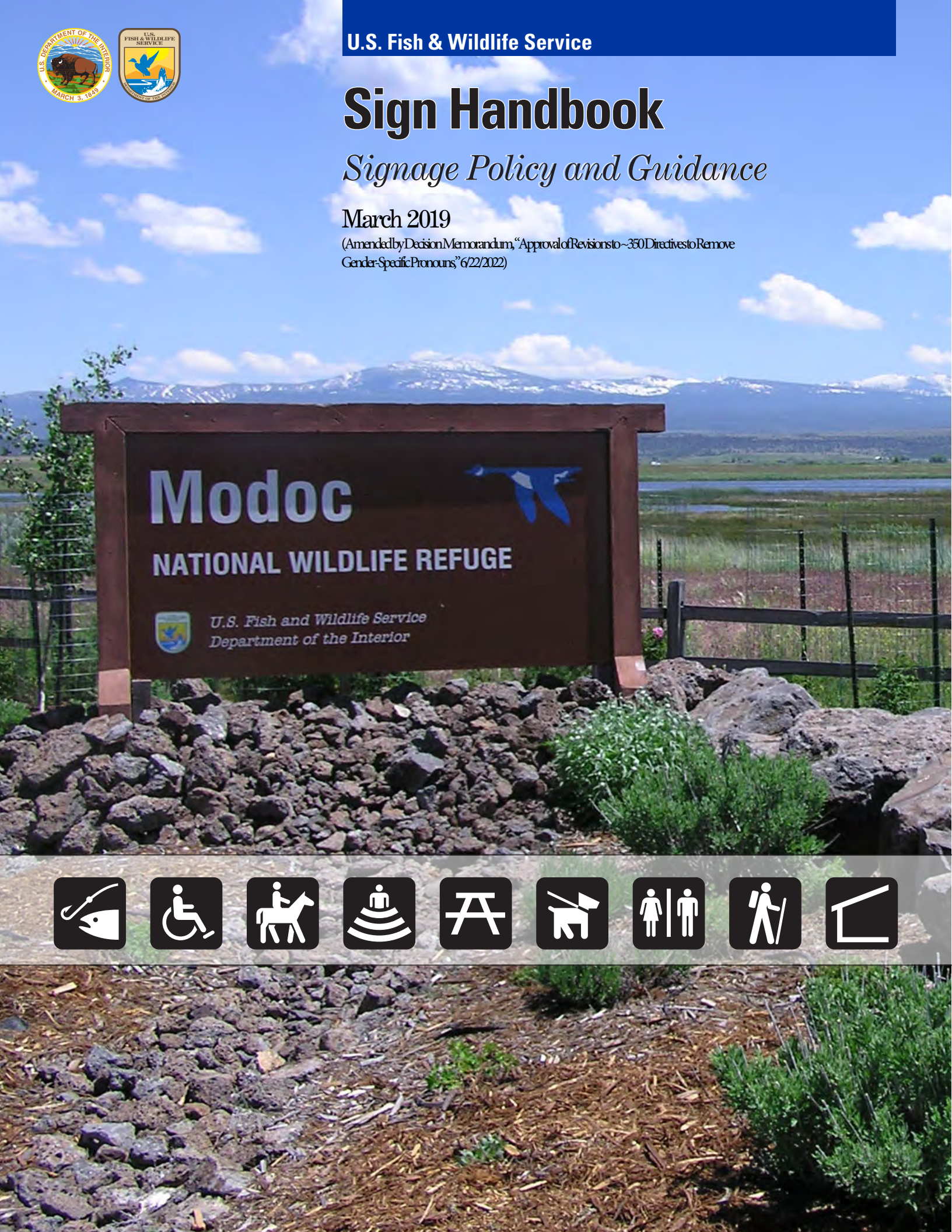

Table of Contents

Chapter 1

Introduction to the Service Sign Handbook	1-1
Service Sign Goals	1-1
Sign Program Objectives	1-2
Organization of this Handbook	1-3
Legal Requirements for Sign Programs	1-4
Regional Office Responsibilities	1-4
Project Leader Responsibilities	1-4
Sign Plan	1-4
Inventory	1-5
Mounting and Installation	1-5
Inspection	1-5
Maintenance	1-5
General Sign Recommendations	1-5

Chapter 2

Sign Types Standards, Materials, and Designs	2-1
Sign Types	2-1
Advance Notice Signs	2-1
Entrance Signs	2-1
Guide Signs	2-1
Area Management Signs (A-Series Signs)	2-2
A-Series Sign Specifications	2-2
Information Signs	2-3
Navigational Signs	2-3
Interpretive Signs	2-4
Traffic Control Devices	2-4
National Recreation Symbols	2-4
Safety Signs	2-4
Emblems	2-5
Decals	2-5
Selection of Sign Materials	2-5
Engineering Criteria	2-6
Substrates	2-6
Sign Face	2-8
Reflectivity	2-8
Sign Colors	2-9
Design Standards for Service Signs	2-9
Sign Rules of Thumb	2-9
Sign Placement	2-10
Overview	2-10
MUTCD Placement Guidelines	2-11
Lateral Clearance	2-11
Viewing Distance	2-12
Position	2-13

Site Placement	2-14
Spacing	2-14
Safety	2-14
Angle	2-14
Height	2-14
Field Test	2-15
Clear Zone Description	2-15
Planning – Station Sign Plans	2-16

Chapter 3

Procedures	3-1
Ordering Signs	3-1
Ordering Standard Signs	3-1
Ordering Custom Signs	3-1
Sign Warranties	3-3
Mounting and Installation	3-4
Standard Mounting Methods	3-4
Guidelines for Installing Signs	3-5
Inventory and Inspection	3-5
Sign Inventory	3-5
Legal Requirements	3-5
Sign Inspection	3-6

Chapter 4

Sign Maintenance	4-1
General	4-1
Sign and Decal Maintenance	4-1
General Maintenance Tips	4-1
Sign Panel Maintenance	4-1
Storing Sign Panels	4-1
Sign Cleaning	4-2
Cleaning Aluminum Signs and Plywood Signs	4-2
Cleaning Wood-Routed Signs	4-2
Removing Stains	4-2
Sign Repair	4-2
General	4-2
Bent Signs	4-3
Bullet Holes and Punctures	4-3
Replacing Vinyl Sheeting and Legends	4-4
Repairing Wood-Routed Signs	4-5
Repainting and Refinishing	4-5
Maintenance of Sign Hardware and Supports	4-6
Ground Maintenance	4-6
Vandalism	4-6
Vehicle Decal Maintenance	4-7
Methods for Removing Vehicle Decals	4-7
Sign Maintenance References	4-8
Sign Posts and Supports	4-9
Sign Posts and Supports	4-9
Small Sign Supports	4-9

Chapter 5

Catalog	5-1
Entrance Signs, Footboard, and Welcome Signs	5-1
Description	5-1

Entrance Sign Guidance	5-3
Welcome and Secondary Entrance Sign Guidance	5-4
Installation and Mounting	5-4
Ready Reference Guide to Area Management Signs.	5-5
Area Management Signs	5-6
Description	5-6
Installation and Mounting	5-6
Maintenance	5-6
A-Series Signs	5-7
Boundary Signs	5-8
Guidance	5-8
Posting A-Series Signs	5-8
Tips	5-8
Types of Boundary Signs	5-8
Designated Area Signs	5-10
Guidance	5-10
Types of Designated Area Signs	5-10
Other Area Management Signs (FWS-A-19 – FWS-A-24).	5-13
Other Site-Specific Signs	5-13
Ready Reference Guide to Information Signs.	5-15
Information Signs	5-16
Placement	5-17
Maintenance	5-18
General Information Signs	5-18
Use/Purpose	5-18
Concession Area Signs	5-19
Service Building Identification Signs	5-19
Placement	5-19
Mounting.	5-19
Ready Reference Guide to Guide Signs.	5-20
Guide Signs	5-21
Description	5-21
Advance Notice Signs	5-23
Guidance	5-23
Placement	5-24
Maintenance	5-24
Interpretive Signs	5-25
Emblems and Decals	5-25
The Service Emblem	5-25
Description	5-25
Vehicle Mounting	5-26
Mounting Reflective Decals	5-26
Methods for Removing Vehicle Decals	5-26
Ordering	5-27
Maintenance	5-27
Other Emblems	5-27
Description	5-28
Federal Recreation Symbols.	5-28
Description	5-28
Placement	5-29
Maintenance	5-29
Ordering	5-29
Traffic Control Devices	5-30
Description	5-30
Other Traffic Control Devices	5-31
Ordering	5-31

Safety Signs	5-31
Description	5-32
Placement	5-32
Mounting	5-33
Ordering	5-33
Maintenance	5-33

Appendix 1

References	A1-1
Legal Authorities for Sign Program	A1-1
Additional References	A1-2

Appendix 2

Color Specifications	A2-1
U.S. Fish and Wildlife Service Emblem Color Specifications	A2-1
U.S. Department of the Interior Seal Color Specifications	A2-2
Common Uses of Sign Colors	A2-3
Pantone Matching Colors for MUTCD	A2-4

Appendix 3

Design Standards for Service Signs	A3-1
Overview	A3-1
Manual for Uniform Traffic Control Devices Design Requirements	A3-1
Message	A3-2
Typography	A3-4
Case	A3-4
Letter Size	A3-4
Line Length	A3-4
Linespace	A3-5
Color	A3-5
Layout	A3-5
Size	A3-5
Arrows	A3-7
Conventional Road Guide Sign Sizes	A3-8
Regulatory Sign and Plaque Sizes (Sheet 1 of 4)	A3-9
Regulatory Sign and Plaque Sizes (Sheet 2 of 4)	A3-10
Regulatory Sign and Plaque Sizes (Sheet 3 of 4)	A3-11
Regulatory Sign and Plaque Sizes (Sheet 4 of 4)	A3-12
Minimum Letter and Numeral Sizes for Expressway Guide Signs According to Interchange Classification	A3-13
Minimum Letter and Numeral Sizes for Expressway Guide Signs According to Sign Type	A3-14
Minimum Letter and Numeral Sizes for Freeway Guide Signs According to Interchange Classification	A3-15
Minimum Letter and Numeral Sizes for Freeway Guide Signs According to Sign Type	A3-16

Appendix 4

Guidelines for Use of Quick Response Codes (QRs)/Tags/NFC Chip Tags on U.S. Fish and Wildlife Signs	A4-1
Definitions	A4-1
Generic Guidance	A4-1

<i>Appendix 5</i>	
Sign Color Equivalents Chart	A5-1
 <i>Appendix 6</i>	
U.S. Fish and Wildlife Service Recreational Symbols	A6-1
 <i>Appendix 7</i>	
Sign Planning	A7-1
Purpose of this Sign Planning Guide	A7-2
Why Do a Sign Plan?	A7-2
Planning for the Sign Plan	A7-2
Visitor Services Review Questions for Your Sign Program	A7-3
Signs and Communicating Important information to People with Disabilities	A7-4
Sign Inventory and Condition Assessment	A7-4
Sign Plan Map Samples	A7-5
Sign Plan Map Code Classification	A7-6
Creating the Sign Plan Document	A7-8
Appendix 1	A7-13
 <i>Appendix 8</i>	
Accessible Signs	A8-1
Legislation	A8-1
Types of Disabilities	A8-2
Types of Accessible Signs	A8-2
Guidelines for Accessible Signs	A8-2
Signs Required at Accessible Facilities	A8-6
References	A8-9
Appendix A	A8-10
Design	A8-10
Content	A8-10
Appendix B – Alternative Formats	A8-11
Communicating to Visually Impaired People	A8-11
Communicating to Learning Impaired People	A8-12
 <i>Appendix 9</i>	
Bilingual Signs and Exhibits	A9-1
Some Things to Consider When Planning Signs and Exhibits	A9-1
Tips for Writing Bilingual Text	A9-2
Design Bilingual Media	A9-2
Planning and Managing the Project	A9-2
Building your Bilingual Infrastructure	A9-2
 <i>Appendix 10</i>	
Interpretive Signs	A10-1
General Signage Principles	A10-1
Ordering	A10-2
 <i>Appendix 11</i>	
Small Sign Pocket Guide	A11-1

Chapter 1

Introduction to the Service Sign Handbook

Signs are frequently the first things that people see when visiting U.S. Fish and Wildlife Service lands. They are important for branding our identity, providing a welcoming experience, ensuring public safety, and minimizing or avoiding wildlife and habitat disturbance. Signs are one of our most effective tools for offering quality customer experiences, sharing key messages with the visiting public, sharing key resource messages, and assisting with navigation both off- and on-station.

An effective sign system enhances our public image and identity. Signs need to share clear messaging and information, be simple and understandable to visitors, and respond to visitors' needs and interests. Too much signage or information can confuse and frustrate visitors. Too little or inadequate signage can create extra workload for staff, Friends organizations, and volunteers to answer questions and assist people with basic information. It may even lead to an unsafe situation.

The Service's policy is to provide a uniform system of signs and markers along our roads, trails, and office buildings to inform, guide, educate, and protect visitors and employees. You can find our policy about Service signs in Service Manual chapter [041 FW 3 Signs](#).

Our goal is to provide professional and attractive signs that, as a whole, communicate messages succinctly and apply sign format and guidelines consistently throughout the Service.

This handbook explains the Service sign program in detail, offers guidance for managing Regional and field station sign programs, and discusses how to develop a basic sign plan and how to determine the appropriate signs to ensure a safe and quality experience for our visitors.

Service Sign Goals

Goals of the Service sign program are to:

- Contribute to quality customer experiences on our lands.
- Increase brand recognition and identity.
- Communicate key messages and information.
- Establish a uniform and consistent appearance and format for signs on all Service lands and buildings.
- Establish a uniform sign plan and inventory strategy.
- Adhere to all regulations in the [Manual for Uniform Traffic Control Devices \(MUTCD\)](#) and national accessibility requirements.
- Improve the graphic and aesthetic quality of all signs.
- Increase the effectiveness of communicating to diverse audiences.
- Reduce accidents and personal injuries on Service lands.
- Develop a cost-effective program.
- Develop a sustainable and environmentally sound sign program at all levels.
- Minimize the amount of signage to reduce wildlife and habitat disturbance.

Sign Program Objectives

Our objectives are to:

- Establish uniform standards for Service signs and sign programs.
- Facilitate effective sign program management.
- Provide guidance for planning, ordering, inventorying, installing, inspecting, and maintaining signs.
- Provide a catalog of standard Service signs.
- Meet all legal requirements for reflectivity, readability, and installation.
- Improve the quality and durability of signs.

The following are guidelines to use in administering a sign program:

1. Signs should deliver understandable messages to visitors.
2. The Service emblem must be used, where appropriate.
3. Signs should convey the Service's primary mission and general information to the public.
4. Signs must comply with accessibility standards ([Americans with Disabilities Act \[ADA\]](#) and [Architectural Barriers Act \[ABA\] Accessibility Guidelines](#), 216 [ADA and ABA 216]) and, where appropriate, accommodate individuals who speak another language. Also relevant are the [Outdoor Developed Area Guidelines](#). (See [Appendix 8](#).)
5. International symbols developed by Society for Environmental Graphic Design (SEGD) should be used where appropriate.
6. Signs must comply with pertinent Federal, State, and local laws in outdoor public use areas, as appropriate.
7. Safety signs must be installed to warn the public of non-obvious safety hazards or to direct safe behavior.

Organization of this Handbook

The table below shows how we organized this handbook.

Section	This section...
Introduction	Describes the goals and objectives of our sign program.
Planning	Provides an overview of sign planning. The information in this section is general in nature and, except as noted, applies to all categories of signs.
Sign Types and Standards	Provides an overview of Service sign standards. The information in this section is general in nature and, except as noted, applies to all categories of signs.
Procedures	Instructions and graphics for how to inventory, plan, order, install, inspect, and maintain signs are provided.
Sign Maintenance	Provides guidelines and tips for the maintenance and care of all types of signs. Sign repair procedures and suggestions for ways to reduce vandalism are included.
Catalog	<p>Lists all standard Service signs. Information is organized by the following categories of signs:</p> <ul style="list-style-type: none">■ Entrance Signs■ Area Management Signs■ Information Signs■ Advanced Notice Signs■ Interpretive Signs■ The Service Emblem and Other Decals■ Federal Recreation Symbol Signs■ Traffic Control Signs and Devices■ Safety Signs■ Fee Area Signs <p>The Catalog section features a Ready Reference Guide, which outlines area management, information, and guide signs. Ready Reference Guides will be your brief overview of the standards and procedures for these signs. We intend for employees who are familiar with our sign program to use them as a quick reference. This subsection does not replace a thorough reading of this Handbook for those who are new to the Service or unfamiliar with the sign program.</p> <p>A brief description is provided for traffic control signs and devices, Federal recreation symbol signs, safety signs, and the Service emblem and other decals.</p>
Appendices	Includes the sign program policy of the Administrative Handbook, suggested vendors, and includes other pertinent information. We will periodically update the vendor and product information.

Legal Requirements for Sign Programs

Highway Safety Act of 1966 ([Title 23, USC Highways](#), redesignated in 2003) requires Federal agencies with jurisdiction over roadways open to public travel to comply with three standards:

- They must have programs to apply traffic engineering measures and techniques, including the use of signs and other traffic control devices, to reduce the number and severity of traffic accidents on these roads.
- They must evaluate their programs periodically and provide a summary to the Federal Highway Administration.
- They must meet the Federal Highway Standards prescribed in the [Manual of Uniform Traffic Control Devices \(MUTCD\)](#).

To fulfill these requirements, the Service sign program includes:

- This Sign Handbook contains both a catalog of Service signs and guidelines for effective sign planning and program management.
- An inventory system for all signs posted on Service lands.
- A system for regular sign inspection and maintenance.
- Periodic evaluation of the sign program and appropriate revision of the sign handbook.
- The national sign inventory website and application that records photos, location and attributes using a [mobile device](#).

Other legal authorities regulating the procurement, installation, maintenance, uniformity, and inventory of Service signs are listed in [041 FW 3, Signs](#).

Regional Office Responsibilities

Each Regional office is responsible for overseeing the sign program for the Region and must appoint a Regional Sign Coordinator to the Service Sign Committee. Specific duties of the Regional Sign Coordinators are in [041 FW 3, Signs](#). Other Regional office responsibilities include periodically reviewing field station sign programs, plans, and inventories; reviewing all custom sign orders; and assisting in the planning and design of interpretive signs. Other Regional personnel, such as visitor services specialists, outdoor recreation planners, landscape architects, interpretive specialists, and engineers may be asked to assist in meeting signage objectives.

Project Leader Responsibilities

Project Leaders must become familiar with and implement the inventory, installation, and maintenance requirements in this handbook, meet the Federal Highway Standards prescribed in the Manual of Uniform Traffic Control Devices and applicable procurement regulations. These requirements are summarized below and described in more detail in relevant sections of this handbook. Project Leaders who allow the use of unauthorized signs and/or allow field stations to fabricate official signs are considered to be negligent in their duties and responsibilities.

Sign Plan

The goal of a sign plan is to provide visually consistent communications to visitors from the entrance to the various facilities and resources within a field station using a cohesive system of signs. This includes Advance Notice Signs (off-station directional signs and Guide Signs (on-station directional signs). and should include all signs that directly impact the site. Sign plans provide a well-thought-out program for the type and placement of signs, consistent messaging, clear Service branding, and improved management on a site. They are the result of input from a variety of people including the Project Leader, law enforcement personnel, maintenance staff, biologists, and visitor services professionals. By planning, field station staff can establish the most effective way to communicate regulations, information, and safety issues to the public. Once created, the sign plan is another tool for managing the site. See [Appendix 7](#) for Developing a Sign Plan.

Inventory

Each field station must maintain a current inventory of all signs used on Service lands and buildings. An inventory should be a complete list, description, photograph, and map of the current signs and their conditions. Sign inventory sheets include size of lettering, sign dimensions, the type of post or mounting, the installation date, photograph of the sign and mounting, as well as vendor information and purchase cost. Inventories can be paper based or digital based using an [app](#) or other technology.

Field stations should be prepared to provide information from their sign inventories to the Regional and/or the National Sign Coordinator. Field stations must also maintain a separate listing of signs needed to satisfy highway safety requirements.

Where relevant, field stations should use their sign inventory to augment their needs listed in the Service Asset Maintenance Management System (SAMMS) and in deferred maintenance (DM). This will make funding for sign needs more feasible since they will be listed as a station asset and can be part of an ongoing replacement project. Staff should coordinate their efforts with their Regional SAMMS Coordinator.

Mounting and Installation

Each field station must ensure that all signs on the station are properly installed. Proper installation includes location, placement, and mounting. Mounting and structures must be engineered to [American Society of Civil Engineering standards](#) and the [Manual for Uniform Traffic Control Devices](#).

Inspection

Each field station must conduct an annual maintenance inspection of all public use signs and complete a sign maintenance inspection form (can be paper or digital). Field stations also must conduct a maintenance inspection every 5 years of all other signs. Boundary signs are excluded from this requirement except at entrances, gates, and public use areas. Included are instructions for conducting inspections in the procedures section of this handbook. The sign inspection forms are held at the field station and are used to document compliance with legal and Service requirements. See the [Sign Inspection Form, Exhibit 8, page 3-17](#).

Maintenance

Each field station must maintain its signs to ensure that they fulfill their purposes and convey a positive image of the Service. Good sign maintenance is good outreach.

We encourage field stations to recycle old signs, posts, and hardware where feasible. Proper disposal of any sign includes defacing any Department or Service identifiers, such as emblems or text that refer to the Department or Service. This ensures that no sign is used outside its intended purpose.

General Sign Recommendations

Visitors need to know what to see, what to do, and why the location exists. The general recommendations are:

- Develop a sign hierarchy that offers a consistent Service identity;
- Signage is consistent and uniform from site to site;
- Implement the project in phases by attrition, by area, and by sign type;
- Develop sign plans to establish consistency, control clutter and make the program cohesive;
- Maximize public safety and reduce liability exposure;
- Engage the visitor by telling the interpretive story that is important to that particular site.

Chapter 2

Sign Types Standards, Materials, and Designs

Information Including Sign Functions and Manufacturing to Layout and Placement

This chapter provides descriptions of the range of signs used on our refuges, hatcheries, and other sites that the public can access. Signs are often the first contact with visitors.

We select signs on and off Service lands according to their function. You can use the following information as a general guideline to select the type of sign needed.

Official signage should be obtained from an approved vendor. Field stations should not create official signs unless they have prior approval from their regional sign coordinator.

Sign Types

We select signs on Service lands and buildings according to their function. You can use the following information as a general guideline to select the type of sign needed.

Advance Notice Signs

Advance Notice Signs are off-site directional signs located along public roads to direct visitors to Service lands. Each State or locality has specific regulations regarding these signs. Check with the local and State highway engineering departments for current regulations and the process of Advance Notice Sign installation. We may make accommodations to meet State or local directional sign requirements that may vary from what we describe in this handbook.

Entrance Signs

Entrance signs to Service lands create a strong first impression. These signs identify field stations by site name and program identifier. The Service logo is also placed on the sign to identify us as the managing agency. Footboards may be added with site information.

Guide Signs

These signs tell visitors how to find facilities on Service lands.

Area Management Signs (A-Series Signs)

These signs designate Service lands and specific uses or restrictions on those lands. Proper signage assists in enforcing refuge regulations and/or assists with law enforcement in their duties. Each type of A-series sign is coded to make it easier to obtain from approved sign vendors. Refer to the page on A-series signs for each sign and its corresponding code. Such signs should be placed within sight distance of one another and no more than 1/8 mile apart. Corners should be appropriately marked with two signs. No sign should be placed above the boundary sign.

Boundary Signs – These signs are used to mark regular intervals (each sign must be visible from the other and may not be more than 1/8 mile from the other sign) to mark the boundaries of Service lands. There are four different types of boundary signs: U.S. Fish and Wildlife Service, National Wildlife Refuge, Waterfowl Production Area, and Conservation Easement Signs.

Designated Area Signs – These signs facilitate the management of Service lands by identifying special areas or functions of specific areas and by describing permitted and prohibited activities within designated areas.

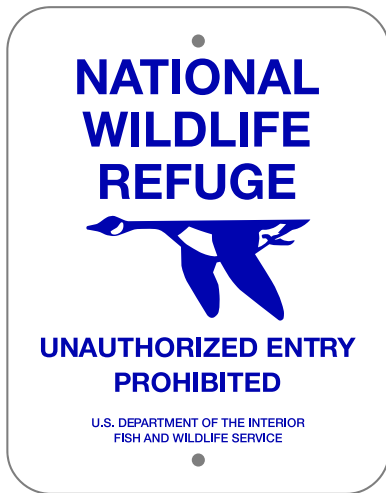

FWS A-2



FWS A-3C

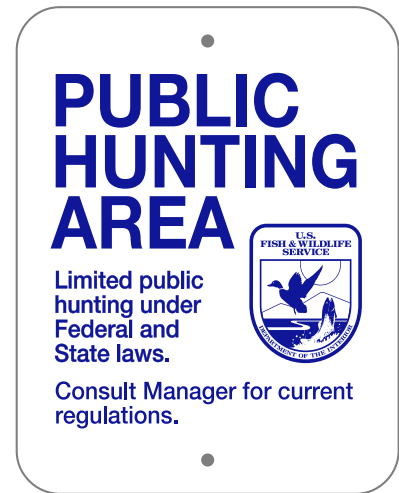

FWS A-5

A-Series Sign Specifications

Substrates:

- 11" x 14" Aluminum blanks .063 thickness
- 3/8" diameter holes (2) 12" on center
- 1" radius corners all sides

Sign Faces:

- Aluminum white finish on face, backs are also white.
- Signs are screen-printed non-reflective using appropriate colors. (PMS Blue 288C and PMS Green 3308C Waterfowl Production Sign only)

Text, Graphics:

- Text Helvetica Medium main copy.
- Helvetica Regular condensed can be used to accommodate smaller text USFWS.
- Text should be no smaller than 1/4" high using upper and lower case letters.
- Graphics consist of logos, Blue Goose size 3" x 6.50" or USFWS 4.50" size emblem.

Design Standards:

- Follow *MUTCD* standards, for sign design and sign placement.
- Follow U.S. Fish and Wildlife Service sign handbook.
- Uniformity and consistency are main goals for A-series signs as they are used on all Service lands.
- Generally larger quantities are ordered for a specific need.
- Some signs can be personalized with a refuge telephone number in small quantities.

Information Signs

General Information Signs – These signs welcome and inform visitors about services, opportunities, regulations, and entrance or user fees at a field station.

Building Identification Signs – These signs identify specific buildings and, if appropriate, show their hours of operation.

Concession Area Signs – These signs identify concession operations and provide information on rates or fees for commercial goods or services offered.

U.S. Fee Area Signs – These signs identify areas that have entrance fees or user fees, and are posted at each designated unit and at other appropriate locations.

Navigational Signs

All signs displayed on waters under the jurisdiction of the Service must conform to the “Uniform State Waterway Marking System” (USWMS). [Titles 33](#) and [46](#), Code of Federal Regulations are applicable on navigable waters of the United States.

[Title 33 Section 403 of the Code of Federal Regulations](#) requires that we obtain a permit from the U.S. Army Corps of Engineers (COE) before installing structures in the navigable waters of the United States. A buoy anchored to the seabed or riverbed is considered a fixed structure or object and requires a permit.

The development of the waterway sign system represents an important step in making our waterways, lakes, and rivers easier to use. Service waterway signs are intended to complement the [U.S. Coast Guard \(USCG\) Aids to Navigation \(ATON\) System](#), not to substitute for that system.

Navigational signs include, but are not limited to:

1. *Danger*: Orange bordered diamond symbol on white background. Words within border may include “Rock,” “Dam,” or “Snag.”
2. *Keep Out*: Orange bordered diamond symbol with cross on white background. Words placed outside the symbol may include “Dam,” “Waterfall,” or “Swim Area.”
3. *Restricted Area*: Orange bordered circle on white background for regulating water use activity. Words placed within border may include “5 MPH,” “No Swim,” “Fishing Only,” etc.
4. *Information*: Orange bordered square or rectangle on white background.

Words placed within symbol may include place names, distances, arrows indicating directions, availability of supplies and facilities, etc.

Interpretive Signs

Interpretation is a mission-based communication process designed to reveal meanings and relationships of our natural and cultural resources to visitors. These signs provide much more than facts; they tell a story and bring meaning and interest to a subject. Interpretive signs communicate specific messages to change behavior, educate, or evoke an emotion. They support management objectives and reveal meanings of and relationships among built, manipulated, natural, cultural, and other features. The interpretive communication process should be based on the principles articulated by Freeman Tilden:

- a. Provoke the attention or curiosity of the audience.
- b. Relate the message to the everyday life of the audience.
- c. Reveal the essence of the subject through a unique viewpoint.
- d. Show the logical significance of an object to a higher-level concept or story line.
- e. Strive for message utility. Use a sufficient but varied repetition of cues to create and accentuate a particular mood, theme, aura, or atmosphere.

Interpretive signs may include trail markers, waysides, interior or exterior exhibit panels, and orientation panels, to name a few. This handbook does not apply any specific “standard” layout or look for interpretive panels. The principles articulated in (a) through (e) above guide interpretive panel designs toward being unique, custom presentations that a particular site can use to bring the information to life for visitors of any age or ability, including tactile panels/exhibits for disabled visitors. We strongly recommended consulting and working with the Regional visitor services staff professionals on any interpretive project.

Traffic Control Devices

Traffic control devices include all signs, signals, markings, and devices placed on, over, or adjacent to roads to regulate, warn, or guide traffic.

The selection, design, and placement of these signs and of any other signs intended to be read from public use roads is governed by guidelines and regulations in the [*Manual on Uniform Traffic Control Devices \(MUTCD\)*](#).

National Recreation Symbols

Symbols are a universally recognizable graphic language that informs visitors of available services, permitted and prohibited activities on Service lands. They may be used alone or on guide, information, and interpretive signs. The National Recreation Symbols were designed for the U.S. Army Corps of Engineers, and refined and augmented by the Society for Environmental Graphic Design (SEGD), with endorsements from the Service. This system includes 112 symbols, 56 prohibitions with a red circle and slash, and 20 warnings in a yellow diamond. Recreation symbols are square with rounded corners.

The U.S. Fish and Wildlife Service Recreational Symbols are located in [Appendix 6](#).

Safety Signs

These signs provide general information and rules relating to health, first aid, and safety.

Caution or Warning Signs – These signs call attention to potential dangers or hazards.

Danger Signs – These signs indicate immediate danger and prohibit activities risking such dangers.

Hazard Signs – These signs identify dangerous or potentially dangerous materials and the places where they are stored.

Notice Signs – These signs provide information defining and controlling access or circulation.

Safety Equipment/Directions Signs – These signs label or direct viewers to fire extinguishing equipment, fire escapes and exits, gas shut-off valves, and sprinkler drains. They also list safety procedures.

Emblems

Departmental Emblem – (310 DM 4) This emblem is the identifying symbol of the Department of the Interior. It is always on the left, before any other emblem.

Service Emblem – (041 FW 2) This emblem is the identifying symbol of the U.S. Fish and Wildlife Service. It can be made of different materials and is used on entrance signs, many area signs, and most Service vehicles (except law enforcement vehicles used for undercover work).

When displayed together, the Service emblem is always to the right of the Department's emblem.

Decals

Along with the Service emblem, other decals are used to identify the Service or Service objectives by placing them on official vehicles, equipment, and exhibits. Colors and sizes are standardized based on how they're used:

- 2" Hardhats
- 4" Small signs, and 2'×4' entrance signs
- 8" Vehicles and 4'×8' entrance signs
- 12" 5'×10' entrance signs, larger signs
- 16" Station entrances buildings, boats
- 20" Station entrances, aircraft, boats

Magnetic decals are available for law enforcement use.

Selection of Sign Materials

Service signs can be manufactured from a variety of materials, including wood, metal, plastic, and high-pressure laminates. When selecting materials for signs, consider such factors as durability, initial cost, maintenance, ease of repair, legibility, nighttime visibility, and aesthetics. Because the information below offers the best combination of these attributes, we consider them the standard. We may update this information as new materials become available or current materials are modified.

Additional factors to consider:

- Signs that are finished front and back create a quality installation.
- Tamper-resistant hardware or concealed attachment points minimize vandalism, so should be used when possible.
- Use materials with the longest possible life cycle. Life cycle requires that the condition of the sign maintain color and material integrity from installation through the life of the sign.
- Use materials that are sustainable.
- Use materials that are appropriate to the installation.
- Use structures that are flexible enough to work well with a variety of materials.
- Mounting and structures must be engineered to [American Society of Civil Engineering standards](#) and the [Manual for Uniform Traffic Control Devices](#).

Engineering Criteria

We use the following criteria as the standards governing material specifications, assembly, and footings for all recreation project signs, unless otherwise specified.

Wind Pressure – 20 pounds per square foot (PSF)

Soil – 1 tons per square foot (TSF) or 2 kips per square foot (KSF) minimum*

Frost Depth – 36" maximum unless otherwise noted

Concrete – 3,000 pounds per square inch (psi) / 28 days

When these criteria are not adequate for a specific sign location, you may need to modify the sign.

Modifications may include, but are not limited to, thicker panels, signs posts that are of a larger dimension, or a larger footing configuration.

The design of the structural requirements of custom signs should conform to the basic assembly specifications for similar sign types. The modified assembly should fulfill the requirements of local criteria for wind pressure, soil, and frost depth.

Substrates

There are a number of good substrates available to meet Service sign requirements. These include:

- Western red cedar with routed and filled legend.
- High density overlaid plywood (HDO) with retro-reflective background with screen printed or digitally printed legends or graphics,
- Aluminum with retro-reflective background and computer-cut retro-reflective legend,
- Aluminum with adhesive vinyl background and computer-cut legend,
- Aluminum-clad plastic,
- Poly-metal signs with any sign making process,
- High pressure laminate (HPL) with digitally printed graphics,
- High pressure laminate (HPL) with retro-reflective background with screen printed or digitally printed legends or graphics,
- Plastic or combinations of plastics or other material,
- Porcelain enamel on steel, and
- HDU (High Density Urethane)

Western red cedar

Western red cedar is one of the most durable woods and offers a look and feel of another era. It has a natural ability to resist moisture, decay, and insect damage. It lies flat, stays straight, and holds hardware tightly. Properly cared for, it will last for decades, even in the harshest environments. The text is routed into the surface of the wood.

Specifications:

- Laminated clear heart, kiln-dried vertical grain redwood or Western red cedar with maximum moisture content of 12%, for panels, fabricated posts and monolith edge.
- Redwood should be selected using the grading rules of the California Redwood Association or better for panels, frames, and posts. You should select cedar using the grading rules of the Western Red Cedar Lumber Association and the National Lumber Grading Authority as approved by the American Lumber Standards Board of Review.

* For all direct embedment and cast concrete footings, backfill in 6" lifts tamped to 95 percent compaction. We assume that subgrade materials are inorganic mixed sand/gravel/silt, with bearing capacity of 1 TSF (2 KSF) min., subject to inspection.

Applications include:

- 1½" thick sign panels.
- 2" lumber (nominal, 1½" finished) with varying widths for finished top cap of monolith and double post assembly, side cover on monolith, leg cover and cap assembly for double post sign, inboard post blocking double post sign, and fascia boards on single post flag-mounted assembly.
- 2" lumber fascia for cross member of flag-mounted single post assembly.

High-Density Overlaid Plywood

High-Density-Overlaid (HDO) ¾" plywood is the standard for most Service signs. This material is specified because it is durable, requires minimal maintenance, and reflective sheeting can be applied to meet requirements for nighttime visibility.

Specifications:

- Panel must be fabricated from HDO plywood, 60-60 non-oiled resin impregnated fiber, black in color.
- All Douglas fir exterior, marine grade, to meet product standard PS1-83; or all exterior plywood PS1- 83 group 1, with B grade veneers on both sides.
- Each panel should be edge-branded marine grade HDO EXT PS1-83; or HDO B-B G I EXT PS1- 83, 7 PLY.
- Panel must be 5/8" thick unless otherwise specified. Panel dimensions must have a tolerance of +. 125"
- Panels must have 0.187" safety corner radius unless otherwise specified.
- Edges must be rounded or beveled to a radius of 0.09375".
- All surfaces must be flat and smooth. Core gaps should be filled with polyester body filler, Bondo, paintable silicone caulk, or some other filler of equal quality. Finish sand all edges and the panel face.
- The back surface must be sanded with 50–60 grit sand paper.

Aluminum

Aluminum is a common substrate for medium to smaller signs and has good weather resistance.

Whenever possible, these signs should be made from recycled materials and be recyclable.

Specifications:

- Panels must be fabricated from aluminum 6061-T6 or T3 alloy as per [ASTM B209](#), to meet or exceed standards as specified in FP-85 Section 71 9.03.
- Surface of panel must be commercially flat and free of buckles, warps, dents, cockles, burrs, and any fabrication defects.
- Panel thickness must be 0.080 (signs over 3 feet in length) or 0.063 (signs under 3 feet in length) depending on type of sign.
- Dimensions for panels must have a tolerance of +0.125".
- No cleats or joints are permitted for panels up to 900 square inches with no dimension greater than 30". All other panels must require reinforcement using a metal framework.
- Panels must have corners with a safety radius of 1" unless otherwise specified.

Poly-metal Signs

Poly-metal is a multipurpose weather-resistant substrate, very rigid and recyclable, and useful for digital printing. This substrate is good for temporary or seasonal signs. Do not use poly-metal for Area Management Signs or any sign designated under the Manual for Uniform Traffic Control Devices.

This material is also useful as a weather-resistant backing for larger signs or interpretive panels.

Specifications:

- Aluminum composite material (ACM) with two .012" sheets of aluminum bonded to a thermoplastic core.
- Available in 2mm, 3mm, 4mm, and 6mm thicknesses.

High-Pressure Laminate (HPL)

This product produces a sign made of high resolution, full color graphics embedded between two durable high-pressure laminate sheets.

The optical topcoat assures UV resistance and is resistant to vandalism. The surface is easy to clean without degrading the graphic imagery.

Specifications:

- HPL sign material is composed of several layers of phenolic (opaque) resin impregnated Kraft filler paper collated to a thickness from 0.093", and surfaced by a layer of coated inkjet graphic image substrate, digitally imaged with UV resistant, pigment-based process color inks, and two UV resistant melamine (clear) overlay sheets. It has a modified acrylic overlay for further UV resistance and hardness, which has been pre-consolidated with an industrial optical coating.
- Layers of material are assembled and heat/pressure consolidated in laminate presses at approximately 1300 PSF at temperatures exceeding 295 degrees Fahrenheit. Once cooled, the paper must completely absorb the melamine to assure a solid thermoset plastic.
- The surface must be a satin-matte that is resistant to marks and diffracts sunlight.

Plastic and/or Combinations

- Acrylic, or Plexiglas, is a hard, rigid material that withstands abrasion well, but breaks easily.
- Polycarbonate, or Lexan, is softer and more flexible than acrylic. Its softness makes it susceptible to weather damage.
- Polyethylene and polypropylene are soft materials that have sufficient rigidity, but are not so rigid that they are easily broken. They weather well, but are susceptible to damage by sharp or pointed objects.
- Fiberglass and epoxy resin mixes, such as Carsonite, are strong but flexible substrates. Its hard, impervious surface is best used as a substrate for decals or screen-printing. It is very resistant to impact and weather.
- HDU (High Density Urethane)

Porcelain Enamel Signs

Porcelain enamel on steel is a substantially vitreous, or glassy, inorganic coating bonded to metal by fusion at temperatures above 1400 degrees Fahrenheit. Porcelain enamel is not the same as baked paints or organic enamels.

Sign Face

The sign face or front may consist of adhesive computer-cut graphics, screen-printed, or digitally printed vinyl adhered to the sign substrate with retro-reflective background and retro-reflective or non-reflective graphics. Reflective sheeting must meet all standards designated in the [*Manual of Uniform Traffic Control Devices*](#) and any future updates.

We will periodically update the material changes and new product information in this handbook.

In the past, signs were created using an adhesive computer-cut vinyl process to create uniformly reflective signs. Today, most vendors use either screen-printing or a digital print process on reflective vinyl. Each process may produce a different appearance of our standard colors. We encourage you to find vendors who use a digital printing process.

Reflectivity

Service reflective signs must use either 3M Engineer – Grade, Prismatic (EGP) 3430 series or High Intensity Prismatic (HIP) 3900 series vinyl. These replace the old 3M Scotch lite Reflective Engineer Grade 3200 series vinyl. These two vinyl series produce better daytime and nighttime brightness, no vinyl layers or cracked letters, and they are greener products that reduce VOC emissions and energy use.

Both vinyls are prismatic and have a gray banding when viewed up close. Reflective 3M EGP series 3430 sheeting or 3M HIP 3900 series sheeting used on a plywood, aluminum, or poly-metal substrate is durable, requires minimal maintenance, and provides the legally required nighttime visibility.

3M EGP is guaranteed to be durable for 5 to 7 years. 3M HIP sheeting has a durability guarantee of 7 to 10 years and has a durable topcoat to protect against scuffs and scratches.

Should reflective vinyl not meet a station’s needs, contact your Regional Sign Coordinator for guidance.

Sign Colors

Colors referenced are based on the Pantone Matching System (PMS) printing inks. Following is a list of all the PMS colors we use on Service signs. A chart with RGB and CMYK equivalents is available in [Appendix 2](#). These equivalents are only approximate and may change from vendor to vendor and by fabrication method.

Colors references are:

Blue (A-Series and Blue Goose)	PMS 288C
Brown.....	PMS 469C
Waterfowl Production Sign Green	PMS 3308C
Desert/Prairie	PMS 468C
Fee Signs	PMS 871C
Coastal Letters	PMS Reflex Blue
Coastal Sign Background Color (Off-white 3M HIP vinyl 3930).....	PMS 427C

Design Standards for Service Signs

Sign Rules of Thumb

Messages

- Maximum of eight (8) words per sign.
- Maximum of four (4) words per message.
- Maximum of three (3) worded messages per sign.
- Maximum of four (4) Recreation Symbols per sign.
- Maximum of one (1) worded message in combination with maximum of three (3) Rec Symbol(s).

Arrows

- Arrows align with those of the longest text line.
- Each message must have its own arrow.
- All arrows on left EXCEPT: Right-pointing arrows placed on right.

Capitalization

- Destinations are ALWAYS uppercase and lowercase letters.
- Directions are all uppercase in the next lower font size.

Fractions

- ¼ and ½ are the ONLY fractions allowed.
- All other fractions are expressed as decimals or feet.

Font Style and Size

- Information Signs are always Helvetica Medium main copy.
- Helvetica Regular condensed can be used to accommodate smaller text.

Margins

- All margins are equal to the height of a lowercase letter.

See [Appendix 3: Design Standards for Service Signs](#).

Sign Placement

For more information on signposts, see [Chapter 4: Sign Posts and Supports](#).

Overview

Uniformity of placement and installation helps users to see the signs and determine what action, if any, is necessary. Proper placement maximizes the opportunity for the sign to convey its intended message.

Place directional signs far enough in advance of the location of the site so that a motorist can react and slow the vehicle or change lanes, if necessary, after passing the sign and before reaching the point where they must turn. Consider the [MUTCD](#) recommendations as absolute minimums. Standardize sign locations whenever possible.

The general rule is to locate signs on the right-hand side of the roadway where drivers customarily look for them. Signs in other locations are supplementary to signs on the right. Placements should follow a uniform plan so that motorists, once accustomed to the plan, will be able to use the system easily. A USDA Forest Service reference handbook, [Placement Guide for Traffic Control Devices](#) (FS 8171 2603) supplements the *MUTCD*, so you should also use it whenever possible.

Locate signs so that they do not obscure each other or hide other roadside objects from view. Place them so you are allowing drivers at least 250 feet to read the sign and an equal distance to react in advance of a turn. Actual distance depends on vehicle speed of approach, clarity of sight lines, and available locations for sign placement. The *MUTCD* provides more information on these factors.

There are no standards for the placement of pedestrian signs. Physical surroundings are important considerations when locating pedestrian signs. They should be highly visible and unobstructed by vegetation or physical features in the area.

Signs should not overwhelm a site or the visitor. Consider fewer signs and better placement to maximize overall message retention and visitor enjoyment of wildlife and the landscape.

Correct placement of signs along public use roads is necessary to:

- Comply with highway safety laws and *MUTCD* requirements.
- Decrease the likelihood or severity of accidents.
- Aid in law enforcement.
- Facilitate public awareness of regulations, directions, information, facilities, and resources.
- Promote aesthetics, uniformity, and a positive image of the Service.

MUTCD Placement Guidelines

All signs the public will view or read from roads must conform to placement standards in the [Manual on Uniform Traffic Control Devices](#). Detailed placement standards for traffic control signs can be found in Part 2 of the *MUTCD*. [Chapter 2M](#) covers recreational and cultural interest area signs. Detailed placement standards for all other signs are found in the catalog section of this handbook. Following are some general placement guidelines:

Lateral Clearance

Lateral clearance is the horizontal distance between a sign and the edge of the traveled way. How fast the viewer is going determines the amount of lateral clearance. Lateral clearance for those traveling at higher speeds needs to be greater than for those traveling at slower speeds. The relationship between viewer speed and lateral clearance is standardized in the *MUTCD*. The distance from the edge of the roadway to the inner edge of the sign can range from 6 to 12 feet.

The normal minimum is 6 feet. In cases where roadside topography precludes the 6-foot minimum, the inner edge of the sign must be no closer than 2 feet from the edge of a roadway with no shoulder and no closer than 2 feet from the outer edge of a shoulder. To ensure that parked or standing vehicles do not obscure signs and for uniformity in placement, always follow the recommended minimum mounting height of 6 feet. For greater legibility at high-speed locations, or in more congested areas, the height of the sign from the ground to the base of the panel can be 7 feet. Lateral clearance is not a consideration for pedestrian signs.

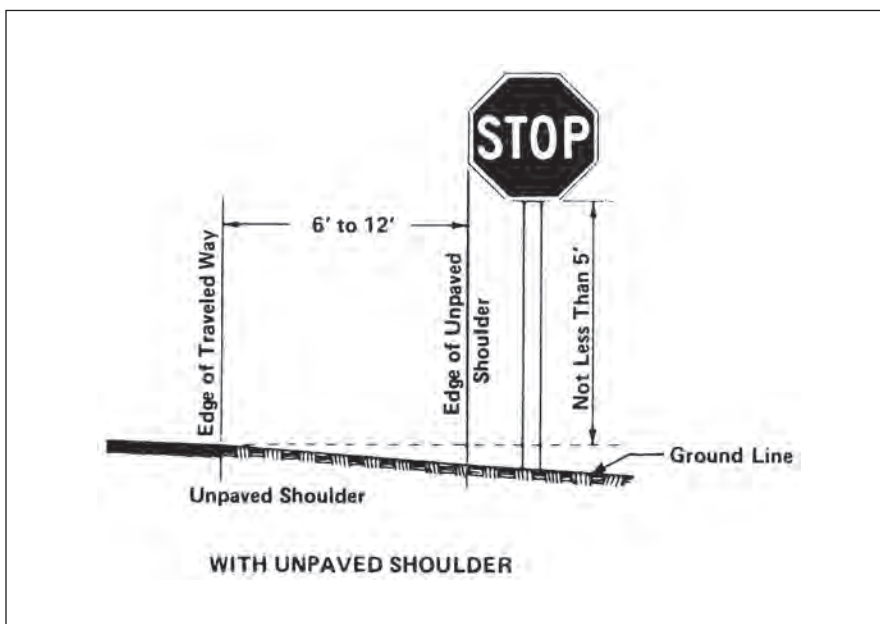
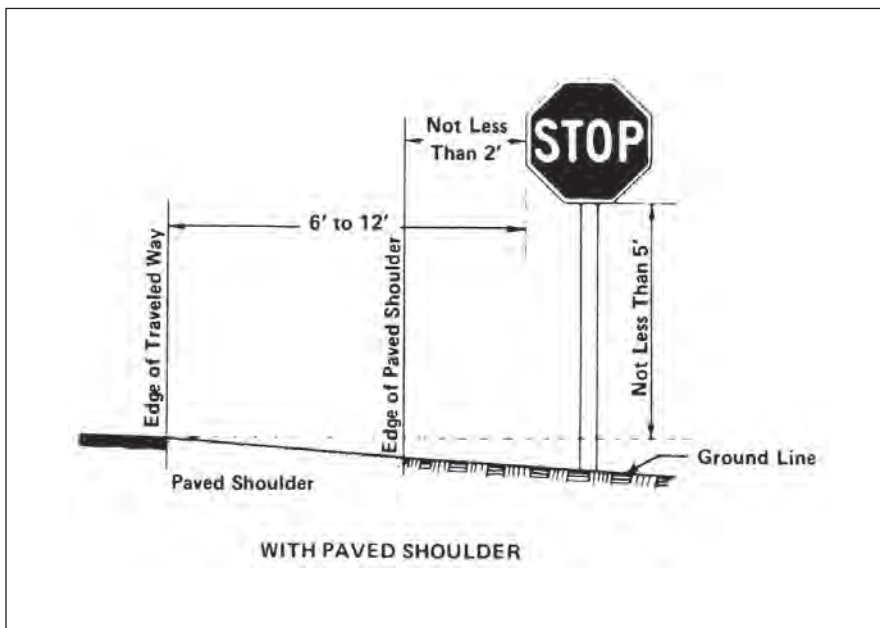

Viewing Distance

Viewing distance is the distance between the sign and the farthest point from which someone could read it. Viewing distance is determined by traffic speed. The higher the speed, the further the sign should be placed from where drivers can read it. The relationship between traffic speed and viewing distance is standardized:

- At 25 mph, eye focus is at 600 feet ahead of the vehicle.
- At 45 mph, eye focus is at 1,200 feet ahead of the vehicle.
- At 60 mph, eye focus is at 1,400 feet ahead of the vehicle.

Speed limit	Distance from sign to intersection or between signs (in feet)
20	100
30	150
40	300
50	500
55	750

The table below identifies letter size as a function of viewing distance and reaction time. It describes the location of the sign in advance of the destination when viewed from an approaching vehicle. Only use this table for comparative purposes and general reference. All letter sizes are calculated for people with a minimum visual acuity of 20/40, in compliance with FHWA standards.

Viewing distance is only a minor consideration for pedestrian signs.

Operating Speed* (MPH)	Detection & Recognition Time (Seconds)	Viewing Distance (Feet)	Letter Size (Inches)	Sign Placement Distance in Advance of Location	
				Single Lane Approach (Feet)	Multi-Lane Approach (Feet)
0–20	3	90	4	200/600	400/900
21–25	3	110	4	200/600	500/900
26–30	3	135	6	250/600	600/900
31–35	3	155	6	300/600	725/900
36–40	3	180	9	375/1300	875/1300
41–45	3	200	9	475/1300	1000/1300
46–50	3	220	9	500/1300	1100/1300
51–55	3	250	12	575/2600	1250/2600
56–60	3	275	12	650/2600	1400/2600
61–65	3	300	12	725/2600	1550/2600

*Operating speed is the 85th percentile speed.

Note: All dimensions are rounded up to the nearest standard size. All distances are rounded up to the nearest 100.

Legend: 200/600 = minimum distance/desired distance.

Position

Signs must be placed within the driver's immediate field of vision. Drivers cannot be expected to turn their heads to read a sign. If you have to mount a sign more than 40 feet off the roadway, you need to use a larger panel to increase readability because the sign is outside the normal field of vision. Consider the following when selecting sign installation locations:

- As vehicle speed increases, driver concentration decreases.
- As speed decreases, driver concentration increases.
- As speed increases, driver's peripheral vision decreases.
- As speed decreases, driver's ability to focus on foreground detail decreases.

Place signs on the right side of the roadway wherever possible. A driver is not conditioned to look to the left side of the road for critical driving information. Exceptions include:

- Signs on the left shoulder of a road where they are directly in front of approaching vehicles, as they would be on sharp curves to the right.
- A two-sided entrance sign to a field station that is placed on one side of the road.

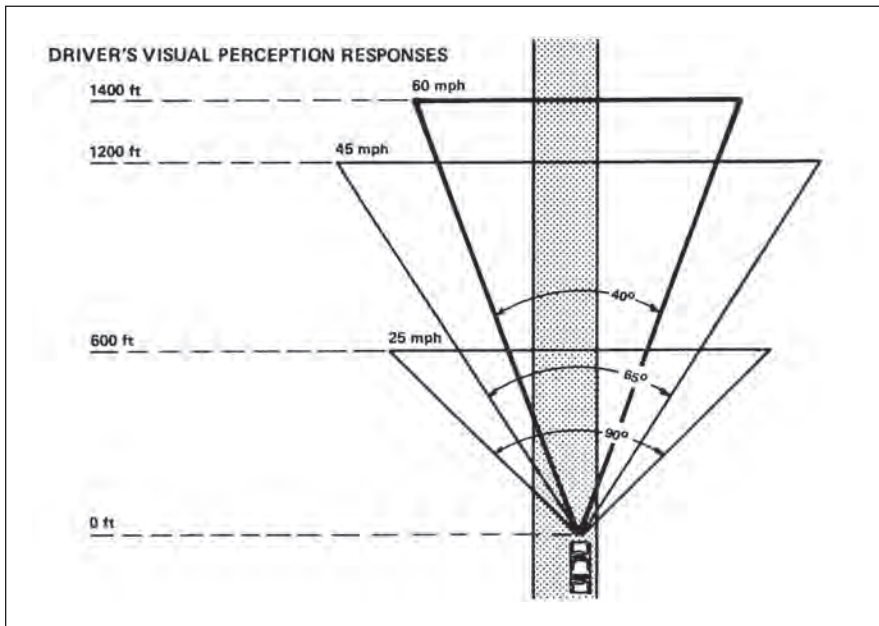

Site Placement

Signs placed along roads must be mounted on bases, posts, or poles and conform to other placement guidelines. Signs closer than 30 feet to the road must be mounted on breakaway supports unless they are protected by guardrails or topographic changes. Because of grade differences or other obstructions, you may have to regrade a site, clear or relocate obstructions, or have a traffic engineering study performed.

Signs meant to be viewed by pedestrians must be placed on bases, posts, poles, fences, or buildings, as applicable. Avoid using trees except in the case of a boundary line tree (see [Land Survey Handbook](#)) and never mount the sign to a power or telephone pole. Site signs where they are easily noticed, but do not interfere with and are not obscured by the natural growth and physical features of an area. In addition, you should anticipate potential obstructions to visibility, such as tree limbs that could press down in front of a sign face under the weight of heavy snow.

Following are some considerations for placing signs in special conditions:

- Guide signs with up to three destination legends must be located not less than 300 feet and not more than 500 feet in advance of the intersection to allow viewers time to see the sign, read the legend, and respond.
- Guide signs with one destination legend must be located not less than 200 feet and not more than 450 feet in advance of the intersection to allow viewers to see, read, and react.
- Junction signs and advance turn arrows should be placed no less than 300 feet in advance of the intersections.
- Symbol signs and route shield direction guide signs should be posted in advance of intersections.
- At primary intersections with three directions on the sign and two or more possible directions of travel and all converging drivers required to STOP, place guide signs beyond the intersection to keep the view open at the stop line.

Spacing

Space signs visible from the road in a uniform manner throughout the field station in accordance with *MUTCD* guidelines. Generally, signs placed on public use roads should be at least 100 feet apart to give drivers enough time to read and react safely to one sign before another is presented.

Safety

Place signs so that they are not distractions or hazards. Locate them in a way that maximizes legibility, minimizes the effects of mud splatter, and conforms with safety guidelines related to fixed obstacles near roads. Signs should not obscure each other and should not be hidden from view by other roadside objects.

You should consult the proper authorities before digging postholes to ensure that posts will not interfere with underground utilities, drainage structures, other underground equipment, and cultural resources.

Angle

Sign faces should always be perpendicular, normally 90 degrees to the direction of, and facing, the approaching viewer. Signs should never be placed parallel to passing traffic. Signs located 30 feet or more from the pavement edge should be turned toward the road. On curves, the angle of the sign should be determined by the course of approaching traffic. Sign faces are normally vertical; however, the faces of all overhead signs should be tilted at least 3 degrees downward towards traffic. This will help to ensure that dirt, dust, snow, and bird droppings do not fall onto the sign face. Sign faces may also be tilted forward or backward from the vertical position to improve the viewing angle on grades.

Height

Heights for *MUTCD* signs along roads are standardized. The lower edges of primary signs must be a minimum of 3 feet above the road level where posted for speeds of 30 mph and over. For roads posted for speeds less than 30 mph, the bottom of the sign should be set a minimum of 30 inches above the ground where the sign is being placed. A lower grade next to a roadway should be raised prior to mounting a sign.

Normally signs for pedestrians should be placed at 5'5", unless this would create an obstruction (e.g., an interpretive sign blocking the view of its subject). Larger signs posted in large spaces or for viewing at greater distances can be placed proportionally higher.

Generally, all letters, words, and symbols on a sign should fall within a 10-degree visual cone for the reader (roughly proportionately equivalent to the width of the 'h' and held at arm's length). When placing signs, consider universal design principles to accommodate all readers. Consider the appropriate height and an appropriate size to accommodate people with visual disabilities. For additional information on universal design principles, see [Wikipedia](#) and [The Center for Universal Design](#).

Field Test

Verify the appropriateness of a sign's placement with a field test. Place a piece of cardboard or brown paper that is the same size as the proposed sign in the proposed location. For signs viewed from a moving vehicle, drive by the test sign to see how it will be viewed.

Clear Zone Description

Clear zone is a concept related to minimizing the number and severity of crashes involving vehicles running off the road. Simply stated, it is a traversable area that starts at the edge of the traffic lane and extends laterally a sufficient distance to allow a driver to stop or return to the road before encountering a hazard or overturning. The traversable area would be considered safe, if there were no fixed objects, unless they are breakaway, and if the roadside geometry (either the fore slope, back slope, or ditch) was flat enough that a vehicle could safely traverse the area without tipping and rolling over.

Roadside safety features include breakaway sign and light posts and traversable drainage structures. Because curbs are not considered a roadside safety feature since they can be easily mounted by errant vehicles, they do not alter how a clear zone is measured. A safe traversable slope can be either a recoverable slope or a non-recoverable slope with a clear run-out area at the bottom.

A recoverable slope is a slope on which a motorist may retain or regain control of a vehicle and recover or stop. Slopes 1:4 (Vertical:Horizontal) or flatter are generally considered recoverable. A non-recoverable, traversable slope is a slope that is traversable, but on which an errant vehicle will continue to the bottom. Embankment slopes from 1:3 and 1:4 may be traversable but non-recoverable if they are smooth and free of fixed objects. A clear run-out area is the flatter area at the toe of a non-recoverable slope that an errant vehicle can use to recover. Slopes steeper than 1:3 are not considered traversable and should not be found in the clear zone.

The objective of roadside safety is to provide and maintain as much clear zone as practical. The design of a clear zone is the minimum width to provide on a project and is dependent on speeds, the roadside geometry, and traffic volumes.

Clear Zone Illustration

Hinge Point: Point where the slope rate changes.

Clear Zone: A traversable area that starts at the edge of the traffic lane, includes the shoulder, and extends laterally enough to allow a driver to stop or return to the road before encountering a hazard or overturning.

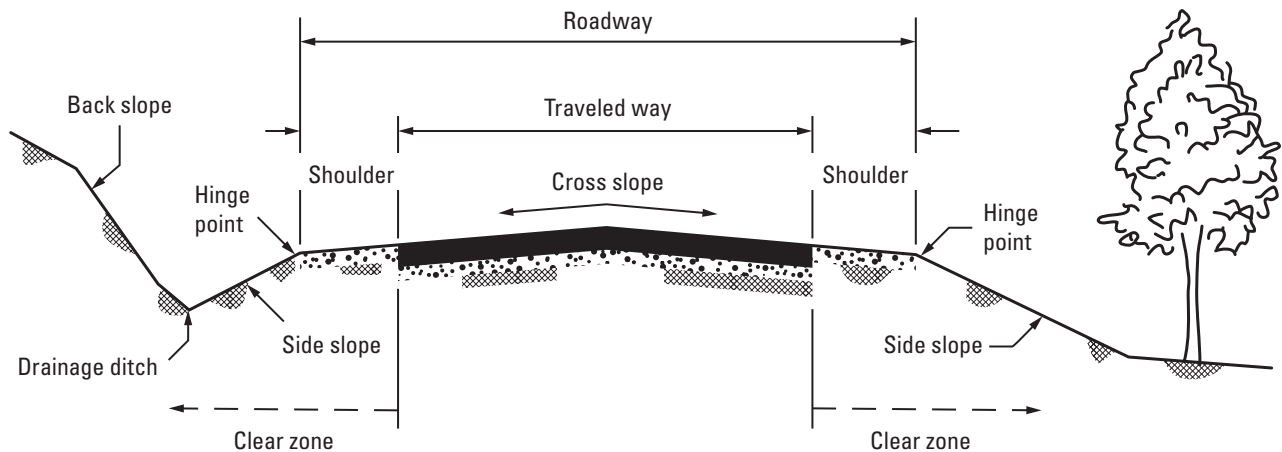

Planning – Station Sign Plans

When developing a station sign plan, staff must carefully consider the relationship a given sign has to others, to the overall station operation, and its visual appearance in the landscape. A sign plan documents how we considered sign development and placement and why we have the sign to begin with.

Each field station must develop a sign plan. Regional Sign Coordinators, Project Leaders, and other line supervisors, as appropriate, must review and approve a station's sign plan.

The format for a sign plan should be simple, containing the sign history and purpose, sign order forms, a site map, maintenance schedules, and a review and approval page.

Maps should be simple yet clearly document placement of all signs. Small stations may use a single, letter size station map to locate and number all signs. Large stations may have to use a system of nested maps. To do this, you could have Map A as a small view of the entire area with the other maps (Maps B, C, etc.) marked. The reader would go to those maps to see details of the signs at those locations. You would assign sign numbers on the maps with larger views, which are important for record keeping functions, including the inventory.

Each station should send their sign plan to the Regional Sign Coordinator and other line supervisor as appropriate, for review. The station keeps the original sign plan after approval, and the Regional Sign Coordinator keeps a copy on file. The Project Leader should ensure that staff enter information from the sign plan into SAMMS for future funding and for replacement.

You may amend a sign plan. When a new sign is needed, send a new sign order form and map to the Regional Sign Coordinator (through the Project Leader and other line supervisor, as appropriate) for approval and attach it to all copies of the plan to amend it. For more information, see [Chapter 3](#).

Chapter 3

Procedures

Ordering Signs

We standardize sign ordering procedures and sources to simplify the ordering process, promote greater uniformity in signs at field stations, and reduce costs. **Field stations must not make signs unless prior approval from their regional sign coordinator.** Under [Title 18, United States Code, Section 4124](#), we must order most standard signs (area management, information, guide, traffic control, Federal recreation symbol signs, and safety signs, and signs using the Service emblem and other decals) from Federal Prison Industries, Inc. (UNICOR), through an IDIQ, or if under \$10,000 credit card, micro purchase limit, from an approved commercial sign vendor. If over the \$10,000 micro purchase limit, then market research and bidding should come into play under the [Federal Acquisition Regulation \(FAR\) Part 8.6](#). Far Part 8.6 states:

- (1) Before purchasing an item listed in the Federal Prison Industries (FPI) Schedule, conduct market research to determine whether the FPI item is comparable to supplies available from the commercial sector. They must at best meet the Government's needs in terms of price, quality, and time of delivery. This is a unilateral determination made at the discretion of the Contracting Officer. The arbitration provisions of [18 U.S.C. 4124\(b\)](#) do not apply.
- (2) Prepare a written determination that includes supporting rationale explaining the assessment of price, quality, and time of delivery, based on the results of market research. Your analysis should compare the FPI item to supplies available from the commercial sector.
- (3) If the FPI item is comparable, purchase the item from FPI following the ordering procedures at www.unicor.gov, unless you get a waiver in accordance with [8.604](#).
- (4) If the FPI item is not comparable in price, quality, or time of delivery –
 - (i) Acquire the item using competitive procedures (provide a copy of the solicitation to FPI. Documentation to the procurement file will be key.)

Ordering Standard Signs

In most situations, you should submit sign orders to the Regional Sign Coordinator for approval and guidance. However, Regional Sign Coordinators may, at their discretion, waive the requirement for Regional approval and authorize field station managers to order standard signs directly from UNICOR or a commercial sign vendor.

Occasionally the Washington office or Regional office may request consolidation of orders for standard signs at the Regional level. Although this procedure is time-consuming, it can reduce administrative costs substantially.

Ordering Custom Signs

General

Entrance signs, information signs, guide signs, and signs with recreation symbols or directional arrows are ordered using Sign Order form FWS 3-2040. Complete a separate form for each type of sign needed.

You must submit backup financial documentation with any sign you order using 3-2040.

Send FWS Form 3-2040 to the Regional Sign Coordinator, who will validate the order, amend it if necessary, and notify you if a change is needed. The Regional Sign Coordinator may waive the submittal requirement or may only request the forms for certain categories of signs.

Orders for custom signs may be placed with contractually approved sources using a purchase order or government credit card. First, get a cost estimate from the Regional Sign Coordinator or a commercial sign vendor, then, submit Form 3-2040 and the finance paperwork to the Regional Sign Coordinator for review, guidance and processing.

A copy of the approved order will be returned to the ordering station. Custom entrance signs must be approved by the Project Leader first, then the Regional Sign Coordinator.

Interpretive signs are ordered through the appropriate contracting office. Field stations should contact their Regional visitor services staff to coordinate developing these types of signs.

After you receive the signs you ordered and accept them as meeting Service requirements, approve and process the vendor's invoice promptly, in accordance with the [Prompt Payment Act](#) or [PPA](#). Immediately contact the vendor about signs that do not meet your requirements. They may except an email or photo. Return any signs to the vendor with a letter explaining the deficiencies. Send a copy of the letter to the Regional Sign Coordinator.

Instructions for completing the Sign Order and Funding Source Form

This information will help you fill out FWS Form 3-2040, the Sign Order Form. Contact your Regional Sign Coordinator if you need assistance:

- Section 1. Ordering Office Information
 - a. Station Name. Self-explanatory.
 - b. Office Contact.
 - c. Shipping Address. Enter the complete shipping address.
 - d. Billing Address. Put billing address if different than shipping.
 - e. Phone Number. Enter the phone number for the station, including area code.
 - f. E-mail contact information.

- Section 2. Sign Type/Substrate/Quantity

The standard substrate for information and guide signs is 5/8" High Density Overlay (HDO) plywood. The HDO plywood is superior to aluminum and most other substrates.

- a. Type of Sign. Check the appropriate box to indicate the type of sign you are ordering. Use a different form for each type of sign needed.
- b. Quantity. Enter the number of signs requested.
- c. Substrate. Check the appropriate box to indicate the type of substrate (material) or write in another substrate.
- d. Double-sided. Check yes if the sign needs to be double-sided or no if it does not.
- e. Reflective Letters: Check yes if reflective letters are needed or no if they're not needed.

These signs are produced with slightly beveled square corners (except Entrance Signs, which have 3" radius corners). The edges of the signs are sealed and painted brown to match the brown reflective sheeting that is affixed to the face of the signs. We use white reflective, Helvetica bold letters (Swiss 721 BT on the entrance signs), and the message will be in both upper and lower case letters. Complete specifications for the standard Service entrance sign are in Chapter 5 of this handbook.

A 1/2" white strip with 2" radius corners borders the edge of all signs. Bicolored signs have both brown and white borders. 11 × 14's have smaller, indented borders.

- Section 3. Standard A-Series signs. Self-explanatory.
- Section 4. Letter Height Requirements. *Consult the Regional Sign Coordinator for guidance.*
 - a. Vehicle Traffic Signs. Check the appropriate letter height requirement based on speed of traffic.

Letter sizes depend on vehicle speed and viewing distance according to the standards in the *MUTCD*. The letter sizes displayed on FWS Form 3-2040 (12", 10", 6", and 4") represent the upper case letters. The accompanying lower case letters are proportionately smaller. If you select more than one letter size for a single sign, the smaller letter sizes should meet *MUTCD* standards, especially for vehicle traffic signs. (See the letter sign charts in [Chapter 2 on page 2-12](#)).

b. Pedestrian Signs. Check the appropriate letter height based on viewing distance.

■ Section 5. Layout. *Consult the Regional Sign Coordinator for guidance.*

a. Determine sign size according to legend layout and speed of traffic. If you check this box, the manufacturer determines the size of the sign based on your design guidelines and the letter height requirements indicated in Section 4. We prefer you use this method because UNICOR and commercial sign vendors are familiar with the standards and legibility is the first consideration.

b. Fabricate to specified dimensions. Check this box if the sign must be manufactured to specific dimensions.

■ Section 6. Price. Gather quote from UNICOR or commercial sign vendor.

■ Section 7. Sign Message and Rough Drawing.

Provide a simple sketch of the sign with the appropriate wording and graphics. The letter style, borders, color, and radius are predetermined in the specifications provided by the Regional Sign Coordinator. Use additional paper, if necessary, and explain in the blank that you are including additional paperwork. Consult the Regional Sign Coordinator for guidance and information.

■ Section 8. Sign Location.

Enter a short description and sketch of where the sign will be installed. Include marginal notes and comments as appropriate to ensure that the sign drawing is interpreted correctly by the Regional Sign Coordinator and sign vendor. Use additional paper, if necessary. The Regional Sign Coordinator will ensure any designs you submit conform to all relevant sign standards.

■ Section 9. Finance Information.

a. Requisition Number. Enter internal tracking number (or the acquisition request number, if appropriate).

b. Cost Center Number. Enter station/office FBMS organization code.

c. Work Breakdown Structure (WBS) and ABC Code. Enter the charging cost code component for this procurement.

d. Fund Code. Enter the FBMS fiscal year code for this procurement.

■ Section 10. Signature Block.

The following signatures are required: Station Manager and Regional Sign Coordinator. Use the other approval line for any additional approvals your station requires.

Sign Warranties

All signs purchased should be warranted as free of manufacturer's defects for a period of 7 years (3M EGP sheeting) or 10 years (3M HIP sheeting) from the original date of receipt (not installation). This warranty would cover delamination of facing materials, loss of reflectivity, legibility, severe fading, and premature weathering. Vandalism and wind sand blasting are not covered. To file a warranty claim, return the sign to the vendor along with proof of original delivery date and, if possible, the original work order number. You should gather this information as a matter of routine and keep it in the station sign files. Send copies of all warranty claims to the Regional Sign Coordinator to track any problems with UNICOR and other commercial sign vendors.

Consult the vendor for warranty information for any sign you get from them, and get all warranty guarantees in writing.

Mounting and Installation

Standard Mounting Methods

Standardized sign mounting methods are used for most signs, except entrance signs and interpretive signs, to create visual uniformity on Service facilities. (Two-sided signs may be used.) There are various ways to mount them. Consult your Regional Sign Coordinator for advice and read [Chapter 2](#) in this handbook on sign placement. See [Exhibit 5](#), [Exhibit 6](#), and [Exhibit 7](#) for mounting illustrations.

There are four main ways to mount signs:

- *Ground mounting* – Mounting a sign on a foundation or base that is level with the ground. These foundations may be concrete, brick, wood, or a material appropriate to the habitat.
- *Post mounting* – Mounting a sign on a post or posts fixed in the ground. Posts may be wood, metal, or materials such as Carsonite. See additional information on post mounting below.
- *Wall mounting* – Mounting a sign on a vertical surface such as a building wall or door.
- *Rail mounting* – Mounting a sign on a rail support or surface.

The mounting method should be appropriate for the type of sign and the viewing requirements. Area management signs, guide signs, traffic control signs, and Federal recreation symbols are usually mounted on posts. Building designation signs, safety signs, and interpretive panels are often wall or rail mounted. Information signs may be either post or wall-mounted.

Generally wood posts are used for post-mounted signs. Wooden sign posts used consistently throughout a facility are visually more harmonious with the surrounding landscape and provide a more finished look than metal posts. The standard post for most signs is a 4" × 4" or 4" × 6" chromated copper arsenate (CCA)-treated wood post, number 2 or better, that is well seasoned and free of defects.

Greener alternatives to CCA posts may be available locally, such as alkaline copper quaternary (ACQ). The Cooperative Extension of the University of Nebraska–Lincoln publication, “Native Wood Fence Posts” (Schmidt and Kuhns, 1990), lists the expected lifespan of many untreated wood species used for fence posts (<http://digitalcommons.unl.edu/cgi/viewcontent.cgi?article=1861&context=extensionhist>).

You may use metal or synthetic (e.g., Carsonite) posts in the following instances:

- For posting signs in remote areas away from general public view, for example, boundary signs in remote areas.
- When replacing a sign mounted on a metal post that is still in good condition.
- When the use of a flexible post may be a safety consideration (e.g., in a parking area where the post may be struck by vehicles).

[Exhibit 5 on page 3-13](#) illustrates how you determine how many posts you need to support sign panels of varying sizes. Signs up to 36 inches across can be placed on a single post, signs 37 to 72 inches across should be mounted on two posts, and signs 73 to 96 inches across should be mounted on three posts.

Signs posted within 30 feet of a road where the speed limit is 35 mph or more should be installed on yielding or breakaway posts unless they are protected by guardrails or topographic change. This applies even if the sign will not be read from the road, such as A-series signs. The following criteria apply to wood posts:

- Single wood posts that are less than 24 square inches in cross section (6" × 4" or smaller) need no breakaway treatment.
- Two posts, each with a cross section no larger than 3" × 6" or 4" × 5" need no breakaway treatment.
- Three posts, each with a cross section no larger than 3" × 5" or 4" × 4" need no breakaway treatment.
- Larger wood posts can be made to break away by drilling three holes through the post starting 4 to 6 inches above the ground and spaced every 6 inches. The diameter of the hole should be 1/3 the thickness of the post. This does not result in significant loss of wind loading capacity or structural strength. Holes should be treated with [CCA preservative](#). Greener alternatives to CCA posts may be available locally, such as alkaline copper

quaternary (ACQ). Breakaway notches may also be used. [Exhibit 6 on page 3-14](#) gives examples of suitable breakaway designs for wooden sign supports. The U.S. Department of Transportation has more information on various breakaway designs developed by State and Federal agencies for sign applications.

Guidelines for Installing Signs

- Position signs so there is a clear line of sight from the viewing point to the sign face.
- Construct sign supports and their foundations to hold signs in the proper position and so that they resist swaying in the wind and are more difficult for vandals to remove.
- Concrete foundations for signposts or supports should be at or below ground level.
- The lower edges of primary signs should be at least 5 feet above ground level.
- Signs posted on roads where the speed limit is 35 mph or more should be at least 12 feet from the edge of the traveled way.
- Signs posted within 30 feet of a road where the speed limit is 35 mph or more should be mounted on breakaway posts unless they are protected by a guardrail or topographic change.
- Use anti-theft, anti-vandal fasteners and hardware to mount signs. The Vandlgard® nut assembly, ‘[Tufnut Security System](#),’ or [SignGrabber](#) are examples of anti-theft, anti-vandal fasteners and hardware (shown in Exhibit 7).
- Raptors or other large birds may get toes wedged into the top hole of pre-drilled steel and U-Channel posts. Make sure the top hole is used or filled.
- Avoid using trees except in the case of a boundary line tree (see Land Survey Handbook) and never mount the sign to a power or telephone pole.
- Consider accessibility requirements where appropriate. See [Appendix 8](#) for further information.

Inventory and Inspection

[Appendix 7: Sign Planning](#)

Sign Inventory

The sign inventory is a system of recording the place and date of installation and compliance with manufacture requirements for all signs. For additional information go to the National Sign Inventory [web site](#).

Legal Requirements

[23 CFR 1204](#) states that we must keep a record of when and where signs are installed and that we must have documentation available to confirm compliance with readability and reflectivity requirements.

Some documentation of area management signs may not be required, such as boundary signs, etc., except at gates, corners, or other unique postings. However, we strongly suggest that all signs are included in your inventory for Deferred Maintenance purposes.

Sign inventory sheets contain specific information on each sign, such as the type of sign, size of lettering, sign dimensions, the type of post or mounting, the installation date, vendor information, and purchase cost. Include a digital photo of every sign in the inventory sheet.

Properly completed, a sign inventory provides all the information and documentation necessary for all types of signs and will support tort claims and minimize our liability. When you order the signs from an authorized source, they ensure the reflectivity and readability specifications are met. A sign inventory also provides the documentation and information necessary to enforce guarantees and obtain replacements for signs that fail due to poor manufacturing or poor quality control.

Where relevant, field stations should use their sign inventory to augment their needs listed in the Service Asset Maintenance Management System (SAMMS). This will make funding for sign needs more feasible because they are part of an ongoing replacement project. Staff should coordinate their efforts with their Regional SAMMS Coordinator.

Sign Inspection

Legal Requirements

Regular inspection of all traffic signs (i.e., all signs posted for viewing from roads open to the public) is a legal requirement in MUTCD. All traffic signs should be inspected annually. Every field station must develop an annual sign maintenance schedule. The schedule should include a description of the backlog of sign projects and an annual work plan that describes how much funding is needed to achieve the goals of the sign program. In addition, regular inspection of all other signs on Service lands is an integral part of good sign program management. Each field station should keep all sign inspection paperwork on file.

Perform condition surveys periodically to determine condition and effectiveness of all traffic control devices, signs, and posters. Inspect reflective devices at night as well as during the day. Evaluate legibility, reflectivity, overall condition of both the sign and its supports, placement, visibility, encroachment of vegetation, and whether or not there is still a need for the sign. Effective sign maintenance helps ensure safe use of Service lands and facilities and fosters a favorable image of the Service in the visitors' eyes. Safety is the most important reason for sign maintenance.

General Considerations for Sign Inspection

A staff member(s) familiar with sign maintenance, procedures, and legal requirements should conduct sign inspections. However, all employees should be observant of sign conditions and report damaged or obscured signs immediately.

A sign inspection includes the following considerations:

1. Need.
2. Damage.
3. Legibility and Appearance.
4. Condition Survey.

Some questions to consider:

- Is the sign in place?
- Is the sign properly installed?
- Is the sign still necessary?
- Is the sign upright and facing in the right direction?
- Is the sign easily seen (i.e., unobscured by vegetation, structures, etc.)?
- Is the sign's support structure or foundation in good condition?
- Is the face in good condition?
- Is the sign's reflectivity still effective?
- Is the surface clean?
- Does the sign comply with the standards in this handbook?

Inspecting the Sign

Use the following guidelines to inspect each part of a sign:

- *Substrate* – Check the substrate for cracks, ply separation, warps, holes, or other damage. The substrate should be level and firmly attached to the supports and base.
- *Face* – If the sign has vinyl or reflective sheeting, check that it is securely bonded to the panel and free of cracks, tears, scratches, blisters, or other damage. If the sign face is painted, check the surface for cracking, peeling, or blistering.
- *Sign Supports* – Check all supports to ensure that they are firmly placed, plumb, and free from rot, cracks, and holes. Masonry structures should be in a good state of repair, and free of cracks and loose mortar. Concrete footings or foundations must be flush with the ground. Additionally, check to see if a breakaway support is required for the sign location.
- *Braces* – Check all braces to ensure that they are firmly in place and free from cracks or other damage.
- *Hardware* – Check all bolts, nuts, washers, and other fasteners to ensure that they are securely fastened and free from corrosion or other defects.
- *Condition Ratings* – Use the following grades to determine the condition of a sign:
 1. *Excellent*. Sign is new or in a like-new condition. Needs no attention. All lettering and symbols are legible. No vegetation or other objects obscure the sign.
 2. *Good*. Sign has experienced some weathering, but its lettering and symbols are legible. The sign is intact with no holes or broken portions. May need some cleaning to eliminate accumulated dirt and minor touchup painting. No vegetation or other objects obscure the sign.
 3. *Fair*. Sign has been extensively impacted by weathering, requiring extensive cleaning and painting to restore it to its original condition. Lettering and symbols are barely legible. Reflectivity is about half of the original. Vegetation is beginning to encroach on the sign, further detracting from the legibility of the message. Sign may have some holes or other minor damage, which can be readily repaired.
 4. *Poor*. Sign is so weathered that its message is no longer legible. It has been refurbished at least once. It has severe damage from holes or other vandalism. It can be repaired temporarily, but it should be replaced as soon as possible.
 5. *Missing/Destroyed/Obsolete*. Either the sign is gone or is so damaged that repairs are impossible, or the sign message is outdated or incorrect. If one or more of these conditions exists, and a sign is still needed, a replacement sign should be ordered immediately.

Inspecting for Nighttime Reflectivity

Studies have shown that while only about a third of vehicle traffic moves after dark, over half of all traffic fatalities occur at night. For this reason, the [Highway Safety Act of 1966](#) (Title 23, U.S.C. Highways, redesignated as 23 CFR 1204 in 1973) requires night inspection of traffic control devices. This includes guide and information signs intended for viewing from a roadway. Reflective signs should be clearly legible when lit by vehicle headlights on low beam. If not, replace the sign.

Exhibit 1: U.S. Fish and Wildlife Service Custom Order Form

**U.S. Fish and Wildlife Service
Custom Sign Ordering Form**

Section 1. Ordering Office Information (See Reverse for Instructions)

a. Office Name: _____ d. Billing Address: _____
 b. Office Contact: _____
 c. Shipping Address: _____ e. Phone Number: _____
 f. E-mail: _____

Section 2. Custom Sign Type/Substrate/Quantity

a. Type of Sign (Check One)
 Entrance/Welcome/Footboard
 Information/Guide
 Non-standard

c. Substrate (Check One)
 HDO Plywood
 Aluminum
 Polymetal

b. Quantity: _____

d. Double Sided: Yes No
e. Reflective Ltrs: Yes No

Section 3. Standard A-Series (FWS-A-__)

a. Type	b. Quantity
A-_____	_____
A-_____	_____
A-_____	_____
A-_____	_____
A-_____	_____
A-_____	_____

Section 4. Custom Sign Letter Height Requirements

a. Vehicle Traffic Signs (Check One)	b. Pedestrian Signs (Check One)
<input type="checkbox"/> 12" 50-55 mph (400 ft. viewing distance)	<input type="checkbox"/> 2 3/4" (75-100 ft. viewing distance)
<input type="checkbox"/> 10" 50-55 mph (300 ft. viewing distance)	<input type="checkbox"/> 1 1/4" (0-75 ft. viewing distance)
<input type="checkbox"/> 6" 35-45 mph (200 ft. viewing distance)	<input type="checkbox"/> 1" (0-35 ft. viewing distance)
<input type="checkbox"/> 4" 0-30 mph (75-100 ft. viewing distance)	_____

Section 5. Custom Sign Layout

Check One Only
 Determine sign size according to layout and speed of traffic
 Fabricate to specified dimensions

Section 6. Price Per Sign

\$ _____ ea. x _____ = \$ _____
 Line Item: _____

Section 7. Custom Sign Message and Rough Drawing

Section 8. Sign Location

a. Description of Location

b. Installation Date: _____

c. Station Sign #: _____

Section 9. Financial Information

a. Requisition Number: _____
 b. Cost Center Code: _____
 c. Work Breakdown Structure/ABC Code: _____
 d. Fund Code: _____

Section 10. Approvals for Custom Signs

Project Leader

Regional Sign Coordinator

Other Requesting Signature Approval

Instructions for completing the Custom Sign Order and Funding Source Form

Section I. Station Information

- a. Station Name. Self-explanatory.
- b. Office Contact.
- c. Shipping Address. Enter the complete shipping address.
- d. Billing Address. Put billing address if different than shipping.
- e. Phone Number. Enter the phone number for the station, including area code.
- f. E-mail contact information.

Section II. Sign Type/Substrate/Quantity

The standard substrate for information and guide signs is 5/8" High Density Overlay plywood. The HDO plywood is superior to aluminum and most other substrates.

- a. Type of Sign. Check the appropriate box to indicate the type of sign you are ordering.
Use a different form for each type of sign needed.
- b. Quantity. Enter the number of signs requested.
- c. Substrate. Check the appropriate box to indicate the type of substrate (material) or write in another substrate.
- d. Double-sided. Check yes if the sign needs to be double-sided or no if does not.
- e. Reflective Letters: Check yes if reflective letters are needed or no if not.

These signs are produced with square corners (except entrance signs, which have 3" radius corners) that are lightly beveled. The edges of the signs are sealed and painted brown to match the brown reflective sheeting that is affixed to the face of the signs. We use white reflective, Helvetica bold letters (Swiss 721 BT on the entrance signs), and the message will be in both upper and lower case letters. Complete specifications for the standard Service entrance sign are in Chapter 5 of the Service Sign Handbook.

A 1/2" white border with 2" radius corners borders the edge of all signs. Bicolored signs have both brown and white borders. 11 x 14's have smaller, indented borders.

Section III. Standard A-Series signs. Self-explanatory.

Section IV. Letter Height Requirements. Consult the Regional Sign Coordinator for guidance.

- a. Vehicle Traffic Signs. Check the appropriate letter height requirement based on speed of traffic.
Letter sizes depend on vehicle speed and viewing distance according to the standards in the Manual on Uniform Traffic Control Devices (MUTCD). The letter sizes displayed on FWS Form 3-2040 (12", 10", 6", and 4") represent the upper case letters. The accompanying lower case letters are proportionately smaller. If you select more than one letter size for a single sign, the smaller letter sizes should meet MUTCD standards, especially for vehicle traffic signs. (See the Service Sign Handbook for more information).
- b. Pedestrian Signs. Check the appropriate letter height based on viewing distance.

Section V. Layout. Consult the Regional Sign Coordinator for guidance.

- a. Fabricate to specified dimensions. Check this box if the sign must be manufactured to specific dimensions.
- b. Determine sign size according to legend layout and speed of traffic. If you check this box, the manufacturer determines the size of the sign based on your design guidelines and the letter height requirements indicated in Section IV. We prefer you use this method because UNICOR and commercial sign vendors are familiar with the standards and legibility is the first consideration.

Section VI. Price. Gather quote from UNICOR or commercial sign vendor.

Section VII. Sign Message and Rough Drawing.

Provide a simple sketch of the sign with the appropriate wording and graphics. The letter style, borders, color, and radius are predetermined in the specifications provided by the Regional sign representative. Use additional paper, if necessary, and explain in the blank that you are including additional paperwork. Consult the Regional Sign Coordinator for guidance and information.

Section VIII. Sign Location.

Enter a short description and sketch drawing of where the sign will be installed. Include marginal notes and comments as appropriate to ensure that the sign drawing is interpreted correctly by the Regional Sign Coordinator and sign vendor. Use additional paper, if necessary. The Regional Sign Coordinator will ensure any designs you submit conform to all relevant sign standards.

Section IX. Finance Information.

- a. Requisition Number. Enter internal tracking number (or the acquisition request number, if appropriate).
- b. Cost Center Number. Enter station/office FBMS organization code.
- c. Work Breakdown Structure (WBS) and ABC Code. Enter the charging cost code component for this procurement.
- d. Fund Code. Enter the FBMS fiscal year code for this procurement.

Section X. Signature Block.

The following signatures are required: Station Manager and Regional Sign Coordinator. Use the other approval line for any additional approvals your station requires.

Exhibit 2: Example of Completed Custom Sign Order Form

**U.S. Fish and Wildlife Service
Custom Sign Ordering Form**

Section 1. Ordering Office Information (See Reverse for Instructions)

a. Office Name: Your Field Station Name Here d. Billing Address: Your Billing Address Here
 b. Office Contact: Your Sign Contact Name Here
 c. Shipping Address: Your Shipping Address (No P.O. Boxes) e. Phone Number: Your Sign Contact Person Number Here
 f. E-mail: contact@fws.gov

<p style="text-align: center;">Section 2. Custom Sign Type/Substrate/Quantity</p> <p>a. Type of Sign (Check One) <input type="checkbox"/> Entrance/Welcome/Footboard <input checked="" type="checkbox"/> Information/Guide <input type="checkbox"/> Non-standard</p> <p>c. Substrate (Check One) <input checked="" type="checkbox"/> HDU Plywood <input type="checkbox"/> Aluminum <input type="checkbox"/> Polymetal</p> <p>d. Double Sided: <input type="checkbox"/> <input type="checkbox"/> e. Reflective Ltrs: <input checked="" type="checkbox"/> <input type="checkbox"/></p> <p>b. Quantity: <u>2</u></p>	<p style="text-align: center;">Section 3. Standard A-Series (FWS A-...)</p> <table border="0" style="width: 100%;"> <tr> <th style="text-align: left;">a. Type</th> <th style="text-align: left;">b. Quantity</th> </tr> <tr> <td>A- _____</td> <td>_____</td> </tr> <tr> <td>A- _____</td> <td>_____</td> </tr> <tr> <td>A- _____</td> <td>_____</td> </tr> <tr> <td>A- _____</td> <td>_____</td> </tr> <tr> <td>A- _____</td> <td>_____</td> </tr> </table>	a. Type	b. Quantity	A- _____	_____	A- _____	_____	A- _____	_____	A- _____	_____	A- _____	_____
a. Type	b. Quantity												
A- _____	_____												
A- _____	_____												
A- _____	_____												
A- _____	_____												
A- _____	_____												

Section 4. Custom Sign Letter Height Requirements

<p>a. Vehicle Traffic Signs (Check One) <input type="checkbox"/> 12" 50-55 mph (400 ft. viewing distance) <input type="checkbox"/> 10" 50-55 mph (300 ft. viewing distance) <input type="checkbox"/> 6" 35-45 mph (200 ft. viewing distance) <input checked="" type="checkbox"/> 4" 0-30 mph (75-100 ft. viewing distance)</p>	<p>b. Pedestrian Signs (Check One) <input type="checkbox"/> 234" (75-100 ft. viewing distance) <input type="checkbox"/> 154" (0-75 ft. viewing distance) <input type="checkbox"/> 1" (0-35 ft. viewing distance)</p>
---	--

<p style="text-align: center;">Section 5. Custom Sign Layout</p> <p>Check One Only <input checked="" type="checkbox"/> Determine sign size according to layout and speed of traffic <input type="checkbox"/> Fabricate to specified dimensions</p>	<p style="text-align: center;">Section 6. Price Per Sign</p> <p>§ <u>80.00</u> ea. x <u>2.00</u> = <u>\$ 160.00</u> Line Item: _____</p>
---	---

Section 7. Custom Sign Message and Rough Drawing

1. Custom Brown Sign "Visitor Center" with left directional arrow.
 2. Custom Brown Sign "Visitor Center" with right directional arrow.
 See separate proposed sample layout sheet.

<p style="text-align: center;">Section 8. Sign Location</p> <p>a. Description of Location Designate right/left turn from entrance road to VC parking area and VC building.</p> <p>b. Installation Date: <u>Proposed Date</u></p> <p>c. Station Sign #: <u>Based on Sign Inventory</u></p>	<p style="text-align: center;">Section 9. Financial Information</p> <p>Your internal tracking number here a. Requisition Number: _____</p> <p>Your FIMS Cost Center b. Cost Center Code: _____</p> <p>Your FIMS WBC and Partial Fund c. Work Breakdown Structure/ABC Code: _____</p> <p>d. Fund Code: _____</p>	<p style="text-align: center;">Section 10. Approvals for Custom Signs</p> <p>Project Leader _____</p> <p>Regional Sign Coordinator _____</p> <p>Other Requesting Signature Approval _____</p> <p style="text-align: right;">FWS Form 3-2000</p>
---	--	---

**U.S. Fish and Wildlife Service
Custom Sign Ordering Form**

Section 1. Ordering Office Information (See Reverse for Instructions)

a. Office Name: Your Field Station Name Here d. Billing Address: Your Billing Address Here
 b. Office Contact: Your Sign Contact Name Here
 c. Shipping Address: Your Shipping Address (No P.O. Boxes) e. Phone Number: Your Sign Contact Person Number Here
 f. E-mail: contact@fws.gov

<p style="text-align: center;">Section 2. Custom Sign Type/Substrate/Quantity</p> <p>a. Type of Sign (Check One) <input type="checkbox"/> Entrance/Welcome/Footboard <input type="checkbox"/> Information/Guide <input type="checkbox"/> Non-standard</p> <p>c. Substrate (Check One) <input type="checkbox"/> HDU Plywood <input checked="" type="checkbox"/> Aluminum <input type="checkbox"/> Polymetal</p> <p>d. Double Sided: <input type="checkbox"/> <input checked="" type="checkbox"/> e. Reflective Ltrs: <input type="checkbox"/> <input checked="" type="checkbox"/></p> <p>b. Quantity: <u>2</u></p>	<p style="text-align: center;">Section 3. Standard A-Series (FWS A-...)</p> <table border="0" style="width: 100%;"> <tr> <th style="text-align: left;">a. Type</th> <th style="text-align: left;">b. Quantity</th> </tr> <tr> <td>A- 2</td> <td>100.0</td> </tr> <tr> <td>A- 9</td> <td>100.00</td> </tr> <tr> <td>A- 13</td> <td>100.00</td> </tr> <tr> <td>A- _____</td> <td>_____</td> </tr> <tr> <td>A- _____</td> <td>_____</td> </tr> </table>	a. Type	b. Quantity	A- 2	100.0	A- 9	100.00	A- 13	100.00	A- _____	_____	A- _____	_____
a. Type	b. Quantity												
A- 2	100.0												
A- 9	100.00												
A- 13	100.00												
A- _____	_____												
A- _____	_____												

Section 4. Custom Sign Letter Height Requirements

<p>a. Vehicle Traffic Signs (Check One) <input type="checkbox"/> 12" 50-55 mph (400 ft. viewing distance) <input type="checkbox"/> 10" 50-55 mph (300 ft. viewing distance) <input type="checkbox"/> 6" 35-45 mph (200 ft. viewing distance) <input type="checkbox"/> 4" 0-30 mph (75-100 ft. viewing distance)</p>	<p>b. Pedestrian Signs (Check One) <input type="checkbox"/> 234" (75-100 ft. viewing distance) <input type="checkbox"/> 154" (0-75 ft. viewing distance) <input type="checkbox"/> 1" (0-35 ft. viewing distance)</p>
--	--

<p style="text-align: center;">Section 5. Custom Sign Layout</p> <p>Check One Only <input type="checkbox"/> Determine sign size according to layout and speed of traffic <input type="checkbox"/> Fabricate to specified dimensions</p>	<p style="text-align: center;">Section 6. Price Per Sign</p> <p>§ <u>12.00</u> ea. x <u>300.00</u> = <u>\$ 3,600.00</u> Line Item: _____</p>
--	---

Section 7. Custom Sign Message and Rough Drawing

Standard A-series sign order

<p style="text-align: center;">Section 8. Sign Location</p> <p>a. Description of Location Marking boundary and hunt/no hunt areas</p> <p>b. Installation Date: <u>Proposed Date</u></p> <p>c. Station Sign #: <u>Based on Sign Inventory</u></p>	<p style="text-align: center;">Section 9. Financial Information</p> <p>Your internal tracking number here a. Requisition Number: _____</p> <p>Your FIMS Cost Center b. Cost Center Code: _____</p> <p>Your FIMS WBC and Partial Fund c. Work Breakdown Structure/ABC Code: _____</p> <p>d. Fund Code: _____</p>	<p style="text-align: center;">Section 10. Approvals for Custom Signs</p> <p>Project Leader _____</p> <p>Regional Sign Coordinator _____</p> <p>Other Requesting Signature Approval _____</p> <p style="text-align: right;">FWS Form 3-2000</p>
--	--	---

Exhibit 3: U.S. Fish and Wildlife Service Acquisition Request Form

FWS FORM 3-2109
MAY 2011

UNITED STATES
FISH AND WILDLIFE SERVICE
ACQUISITION REQUEST

PAGE 1 OF ____

TO:	REQUESTING OFFICE: TELEPHONE:	REQUISITION/ADVANCED PROCUREMENT PLAN NO.
-----	--------------------------------------	---

SUGGESTED VENDORS (NAME, ADDRESSES):	DELIVER TO:
--------------------------------------	-------------

ITEM NO.	DETAILED DESCRIPTION	QUANTITY	UNIT	UNIT PRICE	EXTENDED AMOUNT
(PROVIDE ADDITIONAL SHEETS IF NEEDED)		TOTAL ESTIMATED COST			

1. REQUISITIONED BY (SIGNATURE) NAME/TITLE _____ DATE _____	3. APPROVED BY (SIGNATURE) NAME/TITLE _____ DATE _____
2. FUND CERTIFICATION THE UNDERSIGNED HEREBY CERTIFIES THAT FUNDS IN THE AMOUNT OF \$_____ ARE HEREBY AVAILABLE AND RESERVED FOR THIS TRANSACTION AND AUTHORIZED FOR THE PURPOSE INTENDED. SIGNATURE _____ NAME/TITLE _____ DATE _____	4. UPC CODE 5. FUNDING SOURCE

SIGNATURE BLOCKS 1, 2, AND 3 MUST BE COMPLETED AT THE ORIGINATING OFFICE, BLOCK 2 MUST BE SIGNED BY THE INDIVIDUAL HAVING FISCAL RESPONSIBILITY FOR THE PARTICULAR ACTIVITY. BLOCK 3 MUST BE SIGNED BY THE REQUESTING OFFICE'S PROJECT LEADER/SUPERVISOR.

Exhibit 4: Example of Completed Acquisition Request Form

FWS FORM 3-2109
MAY 2011

UNITED STATES
FISH AND WILDLIFE SERVICE
ACQUISITION REQUEST

PAGE 1 OF ____

TO:	REQUESTING OFFICE: Your Refuge TELEPHONE: 505-555-5555	REQUISITION/ADVANCED PROCUREMENT PLAN NO. SignRequest 4-1001
-----	---	--

SUGGESTED VENDORS (NAME, ADDRESSES): UNICOR or approved sign vendor	DELIVER TO: Your Refuge Name Your Refuge Address Your Refuge Phone Number Your Refuge Contact Name
---	--

ITEM NO.	DETAILED DESCRIPTION	QUANTITY	UNIT	UNIT PRICE	EXTENDED AMOUNT
1	List each sign type/sign materials/traffic control device by line item	XX	ea	XX.xx	XXX.xx
2	Include shipping and handling costs	1	ea	XX.xx	XX.xx
(PROVIDE ADDITIONAL SHEETS IF NEEDED)				TOTAL ESTIMATED COST	

<p>1. REQUISITIONED BY (SIGNATURE)</p> <p>NAME/TITLE _____ DATE _____ Your Name + Date</p> <p>2. FUND CERTIFICATION THE UNDERSIGNED HEREBY CERTIFIES THAT FUNDS IN THE AMOUNT OF \$ _____ ARE HEREBY AVAILABLE AND RESERVED FOR THIS TRANSACTION AND AUTHORIZED FOR THE PURPOSE INTENDED.</p> <p>SIGNATURE _____</p> <p>NAME/TITLE _____ DATE _____ Your Budget Person's Name + Date</p>	<p>3. APPROVED BY (SIGNATURE)</p> <p>NAME/TITLE _____ DATE _____ Your Supervisor's Name + Date</p> <p>4. UPC CODE Station FBMS Cost Center</p> <p>5. FUNDING SOURCE FBMS WBS / Partial Fund codes here</p>
--	---

SIGNATURE BLOCKS 1, 2, AND 3 MUST BE COMPLETED AT THE ORIGINATING OFFICE, BLOCK 2 MUST BE SIGNED BY THE INDIVIDUAL HAVING FISCAL RESPONSIBILITY FOR THE PARTICULAR ACTIVITY. BLOCK 3 MUST BE SIGNED BY THE REQUESTING OFFICE'S PROJECT LEADER/SUPERVISOR.

Exhibit 5. Post Detail

FIGURES FOR HEIGHT AND LOCATION OF VARIOUS SIGNS

Note: The Figure numbers are identical to those in the MUTCD 2009 version.

Figure 2A-2. Examples of Heights and Lateral Locations of Sign Installations

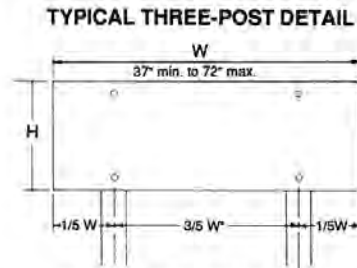
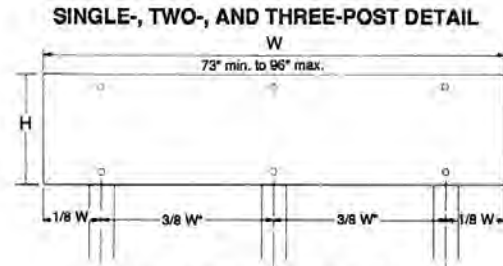
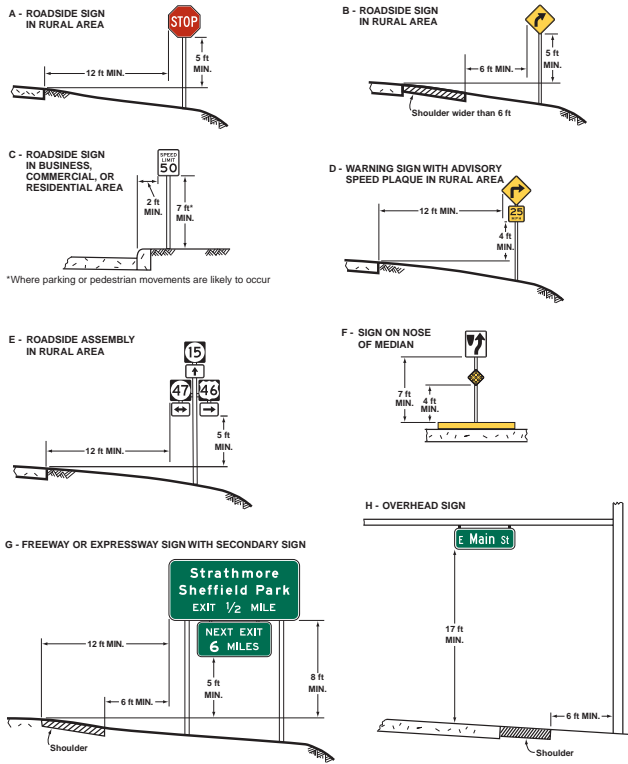

TYPICAL TWO-POST DETAIL
 *This spacing applicable only for signs that are not predrilled.

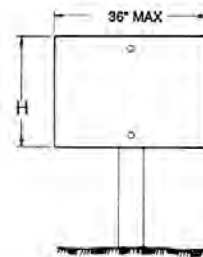

Legend
 W = Width of Sign
 H = Height of Sign

TYPICAL SINGLE-POST DETAIL
 Typical Post Spacing and Maximum Board Size Relationships for Destination Guide Sign Installations



Flexible/Bending Sign Support



Fracturing Sign Support



Controlled Release Sign Support



Cast Aluminum Luminaire Support

Sign Support and Luminaire Bases.

Exhibit 6. Wooden Breakaway Support Guidelines

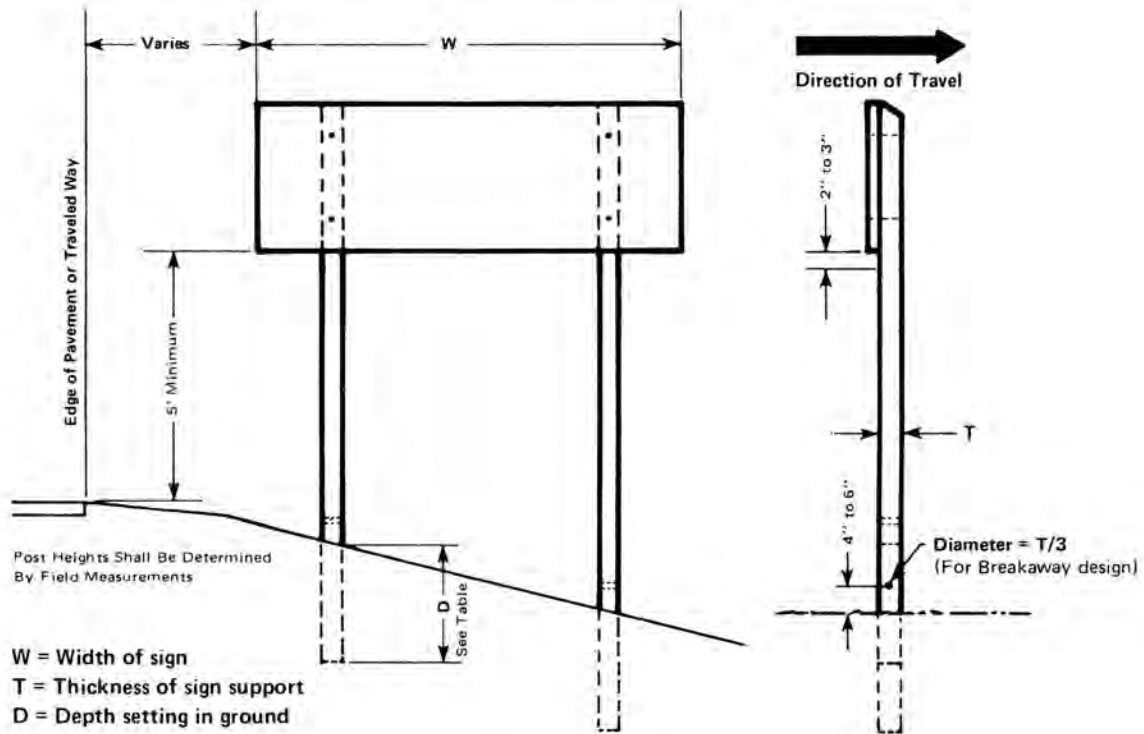

DOUBLE SUPPORT

Breakaway Design Post Sizes ...					
Post size	"D" min.	Single post	Maximum sign area (sq. ft)		
			Double post	Triple post	Quadruple post
4"x4"	3'	10*	20	45	100
4"x6"	4'	15*	35	75	
6"x6"	4'	20**	50	75	

* Use two 4"x4" posts if W is over 3'.
** Use two 4"x4" posts if W is over 4'.

Breakaway design is required for all posts (new and existing) with cross sectional area greater than 24 square inches. Use drilled hole at bottom of support only. Field drill posts and treat hole with preservative.

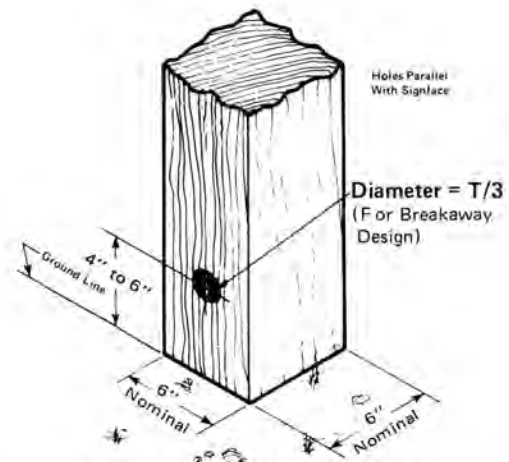

TYPICAL BREAKAWAY SUPPORT

Reducing Shear Resistance Without Substantial Loss Of Capacity To Withstand Wind Loading

Exhibit 7. Anti-Theft, Anti-Vandal Fasteners and Hardware

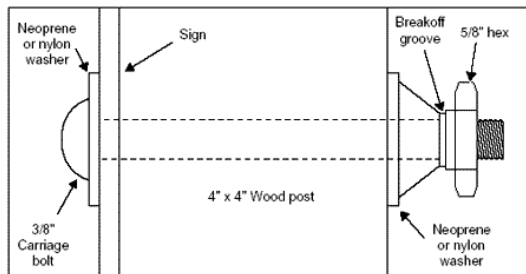

Simple details of anti-theft /anti-vandal fasteners.

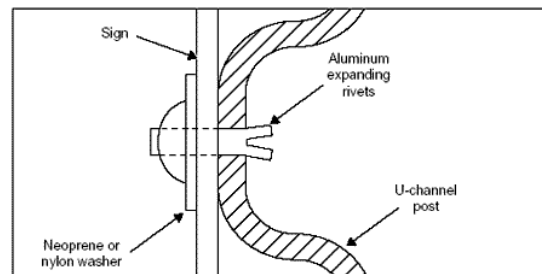

Expanding anchor and blind aluminum rivets.

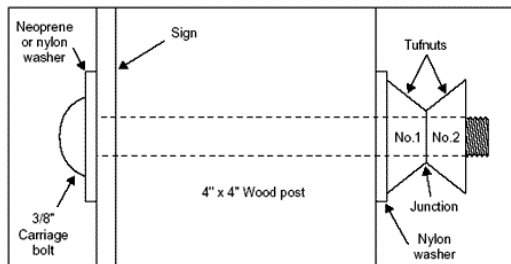

Fluted nuts (double pyramid shape).

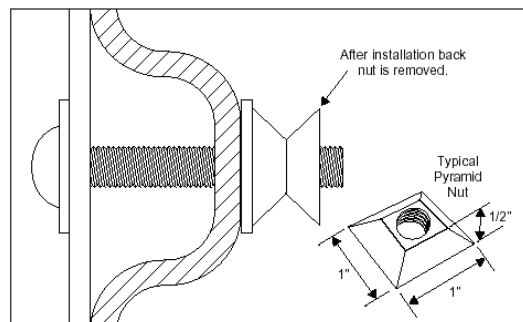

Shear off heads.

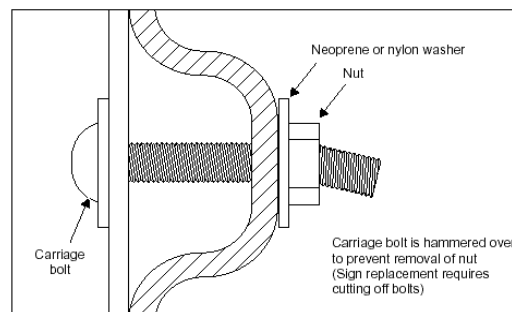

Bent over bolts.

Simi-Fastening Systems

Tufnut Security Nuts and Fasteners

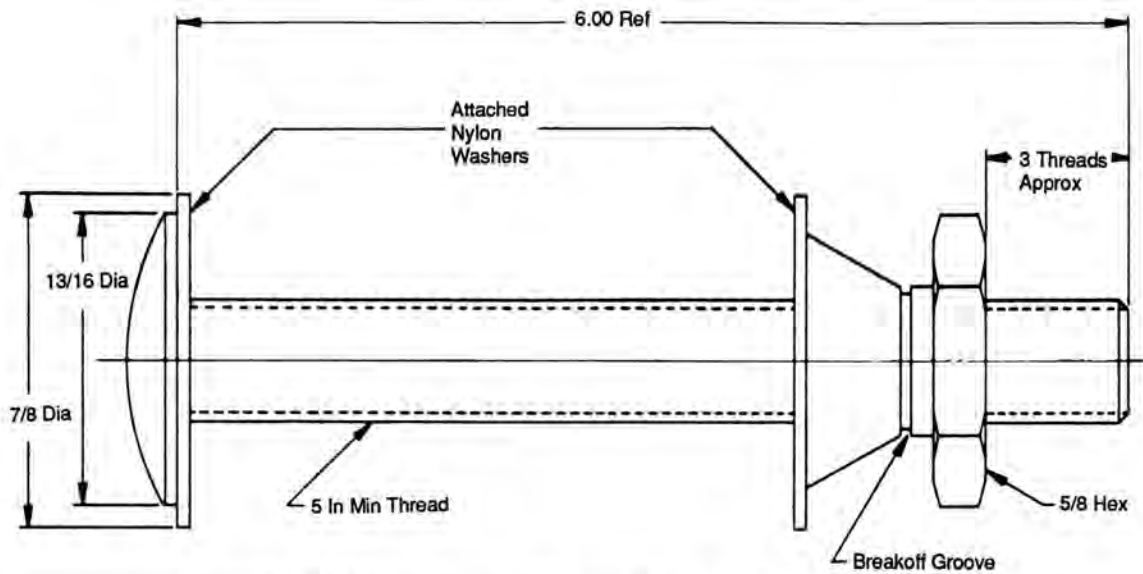

VANDLGARD-NUT—INSTALLATION AND REMOVAL

INSTALLATION

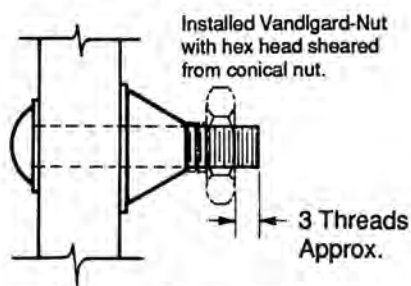

1. Install Vandgard nut by tightening hex until it shears.

REMOVAL

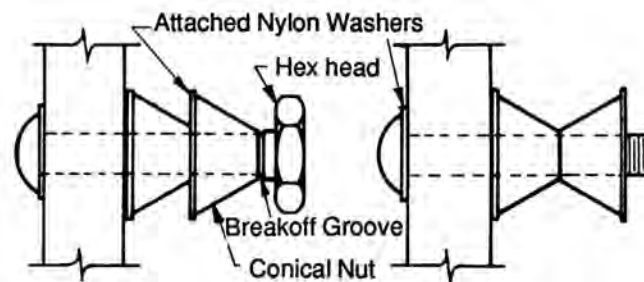

1. Thread on second Vandgard and twist off hex. Remove the remaining conical nut.

2. Install this conical nut in the inverted position.

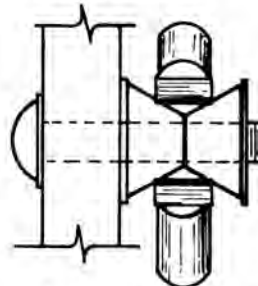

3. Squeeze both nuts firmly with vise-grips and remove both nuts together.

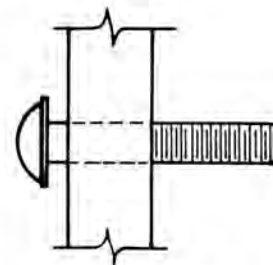

4. Original bolt is undamaged and ready for reuse.

Chapter 4

Sign Maintenance

General

Proper sign maintenance is an important part of an effective sign program. Signs must be inspected and cleaned regularly and repaired, replaced, or removed when necessary. Good sign maintenance fosters a favorable image of our Service lands and employees. Missing, broken, or illegible signs can cause confusion and accidents. In addition, poor maintenance creates an appearance of neglect, which can lead to abuse and vandalism and generate a negative visitor experience.

Sign maintenance is an excellent task to give to volunteers because you can quickly teach the maintenance skills necessary. The work can be laid out easily and volunteers can often provide their own transportation to the work sites. Sign inventory and maintenance is also an excellent project to offer to youth, church, and civic groups. It is a particularly good activity for special youth projects.

Sign and Decal Maintenance

General Maintenance Tips

- Do not waste time and money repairing signs that do not comply with Federal or Service standards. Instead, replace them with appropriate signs or devices that meet the standards.
- Use only those materials (paints, stains, edge tape, sheeting, hardware, etc.) that comply with the original specifications for the sign or traffic control device you are refurbishing. Evaluate the maintained product against the standard for materials and workmanship established for the original.
- When maintaining roadside signs, use appropriate advance warning signs and devices to protect the safety of motorists and workers at each site. See the [MUTCD](#) for more information on the kinds of signs and devices that you may use.
- Remember that careless maintenance can do more harm than good. The same high standards of workmanship apply to this task as to any other.
- Tighten bolts firmly when installing repaired or replacement signs. Do not over tighten as you can rupture the reflective sheeting and the plywood. Place a nylon washer between the bolt head and the sign face to reduce the chance of rupturing the sign face.
- Use theft-resistant nuts (such as Vandlgard®, as shown in [Exhibit 7 on Page 3-15](#), or other similar nuts) when reinstalling signs.
- The sign back is just as important of an element to total sign maintenance as the front.

Sign Panel Maintenance

Storing Sign Panels

- Use good safety practices
- Remove all packing material and slip sheeting so that nothing is against the sign face.
- Store signs upright, not lying down.
- Keep signs away from areas where they may get dirty or wet.
- Keep treated wood posts and other materials away from sign faces.
- Store signs inside. Adjustable square tubing or angle material makes a good storage rack for signs.

Sign Cleaning

Keep signs clean to ensure legibility. This is particularly true of reflective signs for maximum readability. Clean signs with a non-abrasive detergent that is chemically neutral and does not contain strong aromatic solvents or alcohols. Following are steps for cleaning sign faces:

1. Flush sign surface with clean water to remove loose dirt.
2. Scrub sign face with soft brush, rag, or sponge using a mild, non-abrasive detergent or other suitable cleaner. Scrub from the top down. Avoid damaging the surface with unnecessary scrubbing. Use a steady stream of water flowing on the sign face to wash away dirt.
3. Rinse entire sign face with clean water.

Cleaning Aluminum Signs and Plywood Signs

1. Flush the sign surface with clean water to remove loose dirt.
2. Wash the sign face with a soft brush, rag, or sponge using a mild, biodegradable detergent solution or other suitable cleaner.
3. Wash sign panels from the top down and avoid scratching the panel surface with unnecessary scrubbing. If sign letters are applied (die cut and affixed) rather than silk-screened, wash them carefully to avoid loosening their edges.
4. Rinse the entire sign face with clean water and allow it to dry thoroughly.

Cleaning Wood-Routed Signs

Clean redwood and red cedar signs twice a year or more often, if needed, with a *mild* biodegradable soap.

Removing Stains

1. *Tar, oil, diesel, bituminous material* – Use a mild solvent such as mineral spirits. Then wash the surface with mild detergent and water and rinse with clean water.
2. *Pollen and Fungus* – Wash the surface with a 3- to 5-percent sodium hypochlorite solution, such as a commercial brand of bleach, followed by detergent and water. Rinse with clean water.
3. *Lipstick and Crayon* – Use a mild solvent such as mineral spirits to remove the material. Follow with detergent, water, and a clean water rinse.
4. *Paint* – It may be possible to remove paint sprayed onto a reflective sheeting sign face using a commercial paint remover designed for that purpose. The type of paint, length of exposure, and type of remover may affect the life of the sheeting.
5. *Other Severe Contamination* – If you cannot remove the soil with any of these methods, you can try scrubbing it with a very fine steel wool (#00000) or plastic kitchen scour pad. However, unless you are very careful, you may destroy all or part of the sign's reflectivity.

Whenever you have used these special cleaning procedures, be sure to inspect the sign at night to determine if the cleaned area has lost too much of its reflectivity. Replace any signs with insufficient reflectivity.

Sign Repair

General

Use your judgment to determine whether a sign remains as is, or should be repaired or replaced. It may be cheaper to replace a badly damaged sign than to attempt extensive repairs. Compare the repair cost and the likely extended life of the sign with the new sign cost and expected life when deciding whether to repair or replace a sign. Although it is possible to fix minor damage in the field without removing the sign from its support, most repairs require you to work in a workshop.

In areas with a lot of vandalism, it may be wise to order several signs of the same kind at once. The unit cost often goes down as the quantity goes up, and it may be cheaper in the end to have replacement signs on hand than to spend a lot of time repairing signs.

Bent Signs

You can often repair a bent aluminum sign simply by straightening it, unless the legend and background are scraped or severely damaged. Extensive damage to the legend or background requires replacement of the sign.

Bullet Holes and Punctures

It is not always necessary to repair every hole in a sign. When a hole is small, does not damage the message or symbol, and doesn't create a poor image for the Service, consider the cost/benefit when deciding whether repair is necessary. When repairs are necessary, follow the guidelines below to repair bullet holes, depending on the type of sign you are repairing:

Reflectorized Aluminum Signs (small aluminum signs should be replaced)

1. Remove damaged background sheeting and legend.
2. Straighten the sign using a hammer and flat dolly.
3. Remove any additional sheeting damaged during straightening.
4. Clean the entire area with mineral spirits, then with isopropyl alcohol.
5. Patch the bullet hole or puncture on both sides using aluminum foil tape. Apply firm pressure with a squeegee on both sides of the sign. On large holes, start the foil strips at the bottom of the hole and work up, overlapping the strips shingle-fashion.
6. Apply pressure sensitive reflective background sheeting, extending it at least ½ inch beyond the foil tape strips.
7. Replace damaged legend, borders, and symbols.
8. If the sign is subject to snow burial and replacement sheeting extends to the top edge of the sign, place transparent film along the top edge.

Reflectorized Plywood Signs

1. Remove loose wood on both sides of the sign and damaged sheeting.
2. Use exterior-grade wood filler. The new latex compounds will also work. Always read manufacturer's instructions before using cleaning products on vinyl type signs.
3. Place a piece of ordinary household waxed paper over the putty.
4. Using a straight edge or a putty knife, press down and smooth the putty.
5. Sand the patch smooth with a belt sander after the putty has dried (usually about 15 minutes).
6. Patch the bullet hole or puncture on both sides using aluminum foil tape. Apply firm pressure with a squeegee on both sides of the sign. On large holes start the foil strips at the bottom of the hole and work up, overlapping the strips shingle-fashion.
7. Wipe the area with a clean cloth.
8. Apply pressure-sensitive reflective background sheeting, extending it at least ½-inch beyond the patch.
9. Replace damaged legends, borders, and symbols.
10. If the sign is subject to snow burial, and replacement sheeting extends to the top edge of the sign, place transparent film along the top edge.
11. Use an aerosol can of flat enamel (color to match back of sign board), lightly spray the aluminum foil tape covering the holes on the sign back. Keep the paint off the sign face because it destroys reflectivity.

Replacing Vinyl Sheeting and Legends

You can repair minor scratches or small holes in signs with vinyl faces, either aluminum-backed or plywood-backed, with pressure-sensitive sheeting, which comes in pieces or rolls and is available through the authorized sign procurement sources. If there is extensive damage to a sign's vinyl sheeting, replace the sign instead of repairing it.

Reflective sheeting loses its reflectivity over time and has a shelf life of approximately 1–2 years when stored away from light and heat. Therefore, it is not practical or cost-effective to order it in quantities and store it for long periods.

Follow these steps to replace sections of vinyl sheeting:

1. Remove the background sheeting from an area slightly larger than that damaged.
 - Clean the area around the damaged portion of the sign.
 - *Very carefully* heat the section to be removed using a heat gun or heat lamp.
 - Work a sharp, beveled putty knife under the edge of the sheeting and strip it from the adhesive. Remove all sheeting loosened by heat.
2. Clean the surface again with mineral spirits, then with isopropyl alcohol. Apply new reflective sheeting as follows:
 - Separate the sheeting from the liner slightly at one corner or edge.
 - Place sheeting face down on a clean, dust-free surface and remove the liner. If the temperature is below 50 degrees Fahrenheit, activate the adhesive with a heat activator. If it's colder than 50 degrees F outside, do this work in a heated shop, if possible.
 - Gently position the sheeting correctly on the surface being repaired, overlapping the surrounding sheeting to prevent premature sticking. Tack the sheet in place by finger pressure at two points on the upper edge, and then press it firmly to the surface with a squeegee. Use overlapping strokes, starting at the center and working out to the edges. Initial squeegee pressure must be very firm to avoid forming air pockets near the upper corner. Lift the upper corners back beyond the tacked sheet to prevent wrinkles at the tack points as the application proceeds to the edges.
 - Squeegee the edges again using very firm pressure, and then wipe the face of the patch sheeting with a soft cloth to remove any surface dust.
 - If the sign might be buried in snow, and replacement sheeting extends to the top edge of the sign, place transparent film along the top edge.
3. Once the reflective sheeting is applied, replace the damaged legend using these steps:

Letter Application:

1. Clean the surface thoroughly with a soft cloth and cleaning solution (alcohol works very well) to remove oils, dirt, etc., and measure for correct placement of the graphic.
2. Tape the graphic in place along the top to create a "hinge."
3. Hinge the graphic up and remove the release liner to expose the adhesive.
4. For longer graphics, hinge with tape in the center, then cut and remove half the release liner.
5. While holding the graphic out to avoid contact with the application surface, begin firmly burnishing from side to side with the squeegee, working from the top down. Be careful to let the adhesive touch only as the squeegee presses it against the surface.
6. Slowly peel the application tape from the graphic at a 180° angle.
7. Lay the shiny side of release liner down and burnish it into place with the application squeegee. Do the same for the other half and burnish into place.

Removal of Logos & Letters:

1. Scrape off lettering using Lil' Chizler®. Start at a corner and work diagonally.
2. Use mineral spirits to help lubricate.
3. Wipe off silver residue with the spirits.
4. Remove mineral spirit residue with glass cleaner.
5. Before you apply/line up the letters or logo, remove the clear acetate sheet.
6. Follow the steps above for application instructions.

Repairing Wood-Routed Signs

1. Clean the damaged area.
2. Use an exterior wood filler or latex compound.
3. Place a piece of ordinary household waxed paper over the putty.
4. Using a straight edge or a putty knife, press down and smooth the putty.
5. Sand the patch smooth after the putty has dried (usually about 15 minutes).
6. Pencil in the outline of any damaged text.
7. Reroute the message, using a router bit of the same width and depth as the original routing.
8. Repaint the message, first with a primer/sealer. Let dry, then apply enamel or latex paint, using an artist's brush.
9. After the message enamel has dried, the sign face and back can be repainted or refinished.

Repainting and Refinishing

Wood Signs

When repainting signs, use ready mixed, exterior type latex or enamel house paints or stains. Contact your Regional Sign Coordinator for specific color information.

Before repainting or refinishing the background of wood routed signs, repair any holes in the message portion of the sign as described above.

The following tips may help you apply the paint or stain:

- Use a 1/8-inch-thick polysponge roller (standard fabric rollers may spread the paint or stain into the routed area).
- Avoid getting too much paint or stain on the roller.
- Use light pressure on the sign surface.
- Move the roller in a criss-cross pattern to speed coverage.
- Eliminate any bubbles by rolling the surface with a dry polysponge roller.

Reflectorized Plywood Signs

When repainting the back of a reflectorized plywood sign, be careful not to get paint or finishing agents on the front of the sign panel because they damage the reflective surface.

Maintenance of Sign Hardware and Supports

- Inspect all hardware, including bolts, nuts, washers, and other fasteners, to ensure that they are tight and free from corrosion and damage.
- Replace missing, damaged, and corroded hardware and tighten loose bolts and fasteners.
- Use theft-resistant nuts (such as Vandlgard®) when installing signs.
- Where hardware is visible, you may want to paint the head of the bolt to match the sign face and the nut to match the supports. The Vandlgard® nut assembly is available in green, grey, gold, and natural zinc colors. The colors represent specific applications for the hardware; (e.g., green = wood to wood and will shear when enough torque is applied, gold = metal-to-metal, etc.).
- Tighten bolts firmly, but not too tight, when securing soft materials such as plywood. Tightening bolts too tight can rupture the reflective sheeting and the plywood overlay.
- Place a nylon washer (supplied in Vandlgard® nut assemblies) between the bolt head and the sign face to reduce the chances of rupturing the sign face.
- Straighten sign supports that are not plumb and replace cracked or damaged supports as soon as possible.

Ground Maintenance

Keep sign faces clear of obstructions, such as weeds, trees, shrubs, and construction materials. Landscaping around signs should not detract from the signs and should be in harmony with the surrounding environment, whether it's natural or fabricated.

Vandalism

The problem of vandalism is an important consideration in a sign maintenance program. Defacement and destruction of signs occur on all Service lands. Vandalism ranges from scribbling, gunshots, and painting to outright theft. We recommend the following steps to help reduce vandalism:

- Use materials that continue to perform the sign function even when marred. For example, a plywood or routed wood substrate reduces the effects of bullet damage (when bullets enter the face of the sign).
- Use vandal-resistant hardware to prevent signs from being easily loosened and carried away.
- Use anchor rods or cleats at the bottom of the signpost to prevent its rotation or removal.
- Place signs that must be close to the roadway at the maximum practical mounting height. Do not locate signs near pullouts if you can avoid it legally. Careful site consideration will accomplish the need for the sign while minimizing vandalism.
- Place signs as far from the edge of the pavement as practical/possible.
- Make repairs or replacements promptly. You may eventually wear down persistent vandals by demonstrating resolve.
- Vandals target negatively worded signs more frequently than positively worded signs.

Vehicle Decal Maintenance

Methods for Removing Vehicle Decals

There are two methods to remove decals from a vehicle.

Method #1 – Hair Dryer Method

Needed Items:

- Hair dryer
- Plastic scraper
- Extension cord
- Odorless mineral spirits
- Clean rags

Step 1: If possible, move the vehicle into a heated garage.

Step 2: Use a hair dryer to heat up the decal, starting with a corner.

Step 3: Take the plastic scraper and carefully work up a corner of the decal while using the dryer.

Step 4: Once you have a corner started, carefully and slowly pull the decal at a sharp angle with one hand while keeping the hair dryer going with the other. *Do not pull decal straight out from the surface of the vehicle.*

Keep repeating steps 2–4 until you have the entire decal removed.

Step 5: If any adhesive residue remains, use the mineral spirits to clean it up. Be sure to wipe the vehicle surface thoroughly clean after using mineral spirits. Mineral spirits can leave behind an oily residue that could destroy the paint finish and your new decal will not stick.

Method #2 – Mineral Spirits Method

Needed Items:

- Plastic scraper
- Odorless mineral spirits
- Clean rags

Step 1: If possible, move the vehicle into a heated garage.

Step 2: Take a clean rag and saturate it with the mineral spirits.

Step 3: Apply the rag to the surface of the decal, paying special attention to the edges and allowing the mineral spirits to soak the decal.

Step 4: Using the plastic scraper, start carefully working up a corner of the decal.

Step 5: As you expose the backside of the decal, re-saturate your rag with mineral spirits and apply it to the back of the decal, letting the spirits run down behind the decal.

Keep repeating steps 3–5 until you have the entire decal removed.

Step 6: If any adhesive residue remains, use the mineral spirits to clean it up. Be sure to wipe the vehicle surface thoroughly clean after using mineral spirits. Mineral spirits can leave behind an oily residue that could destroy the paint finish and your new decal will not stick.

Sign Maintenance References

There are five excellent documents available that provide in-depth guidance on sign maintenance.

[Maintenance of Signs and Sign Supports](#), FHWA-SA-09-025

[Maintenance of Small Traffic Signs](#), FHWA-RT-90-002

[Maintenance of Signs and Sign Supports for Local Roads and Streets](#), FHWA-RT-00-00

[Methods for Maintaining Traffic Sign Retroreflectivity](#), FHWA-HRT-08-026

[Maintaining Traffic Sign Retroreflectivity](#), FHWA-SA-07-020, Updated 2013.

Sign Posts and Supports

This document is provided directly from [The Center for Transportation Research and Education](#) as a reference.

Sign Posts and Supports

To address various signing needs and agency preferences, several types of supports are available. Small signs (less than 50 square feet) are commonly supported with either wood or steel posts. When available and with permission, small signs also can be mounted on existing utility or roadway light poles. Larger signs (greater than 50 square feet) may be mounted on specially designed steel or aluminum structures such as trusses, bridges, or cantilevered supports.

Small Sign Supports

Small sign supports are generally either wood or steel. Wood posts are available in standard sizes of 4×4, 4×6, and larger. Box beams of laminated plywood are available to support larger signs. Major types of steel sign posts for small signs include U-channel, round pipes, and square tube. Consider sustainable alternatives whenever possible.

Posts for small signs are installed by direct driving, drilling and backfilling, or setting in a concrete foundation. In soft or sandy soils, use of soil-bearing plates or concrete footings may be required to hold the sign in a stable position.

All sign supports located within the clear zone* of the road or street must meet acceptable breakaway standards. Small sign steel supports described above and 4×4 wood posts generally meet breakaway standards when installed in “normal soil” conditions, and may be used within the clear zone without barrier protection. When soil-bearing plates or special foundations are needed in sandy or marshy soils, you should consult with the Department of Transportation or Federal Highway Administration.

Breakaway criteria adopted by the FHWA assume a 7-foot path width for vehicles. (It is assumed that all posts less than 7 feet apart would be impacted simultaneously.) The table “Common Sign Posts,” on the following page, lists the number of posts of various types and sizes that can be installed within a 7-foot width and still meet breakaway requirements.

* Clear zone is an unobstructed area adjacent to the traveled way that is provided to enable an errant driver to return to the road or stop without potential for a serious crash. Criteria for determining clear zone width are contained in AASHTO’s [Roadside Design Guide](#).

Common Sign Posts¹	
Description	Maximum in 7-foot path
Wood Posts, Southern Yellow Pine²	
4" x 4", direct burial	2
4" x 4" with two 1" holes, in 24" diameter, 30" deep concrete foundation	2
4" x 6" with two 1.5" holes, direct burial	2
4" x 6" in 18" diameter, 30" deep concrete foundation	1
4" x 6" with two 1.5" holes, in 24" diameter, 30" deep concrete foundation	2
6" x 6" with two 2" holes, in 24" diameter, 30" deep concrete foundation	1
6" x 8" with two 3" holes, in 24" diameter, 30" deep concrete foundation	1
U-Channel, 80 ksi Steel (Marion Steel)	
3-ppf and less, direct burial	2
3-ppf and less with 6" splice and two grade 9 bolts and spacers on 4" centers	3
4-ppf and less with 6" splice and two grade 9 bolts and spacers on 4" centers	2
Steel Square Tube, 33 ksi (Unistrut Corp.)	
1.75" square in a 2" square 12-gauge (Ga.) anchor	3
2.0" square and smaller, 12-gauge post in the next larger size anchor	2
2.5" square and smaller, 10-gauge post in the next larger size anchor	1
2.5" square and smaller, 10-gauge post with triangular slip base	3
Steel Square Tube, A570, 12 or 14 gauge (Allied Tube)	
2" square and smaller 14 gauge in a 12-gauge anchor	2
2.25" square 14-gauge post in a 12-gauge anchor	1
Slip Base	
S7 x 15.3 steel posts, inclined slip base, and concrete foundation	1
8" x 4" x 3 /16" thick steel tube, inclined slip base, and concrete foundation	1
W6 x 12 steel post, omni-direction slip base, and concrete foundation	1
Breakaway Couplings (Transpo Industries, Inc.)	
45-ppf and less, and a weight of 600 pounds below the hinges	1
18-ppf and less, and a total weight of 600 pounds below the hinges	2

¹ In "standard" soil or in concrete as noted. Contact the manufacturer for other soil types and for installation details.

² Holes in wooden posts are drilled on the center line of the sides of the posts, perpendicular to the direction of adjacent traffic at heights of 4 and 18 inches above the ground. See the illustration "Typical breakaway modification for wood sign posts" on page C14.5.

Source: Arthur Breneman

Wood Posts. Wood posts are most commonly 4x4, available in lengths from 10 to 14 feet and 4x6, usually in lengths of 16 to 24 feet. The length of the post is dictated by elevation of the selected location in relation to road surface and desired embedment (usually recommended at approximately 4 feet). To select the proper size and number of wood posts for a given sign, refer to the diagram, "Determination of sign post size and number," at the bottom of this page.



Wood post

In addition, these dimensions can be used as a guide to select the size and number of wood posts:

<u>Sign Area</u>	<u>Post Number and Size</u>
less than 10 sq. feet	one or two 4x4s
10-20 sq. feet	one 4x6 or two 4x4s
20-50 sq. feet	two 4x6s
50-75 sq. feet	three 4x6s or steel
greater than 75 sq. feet	steel posts

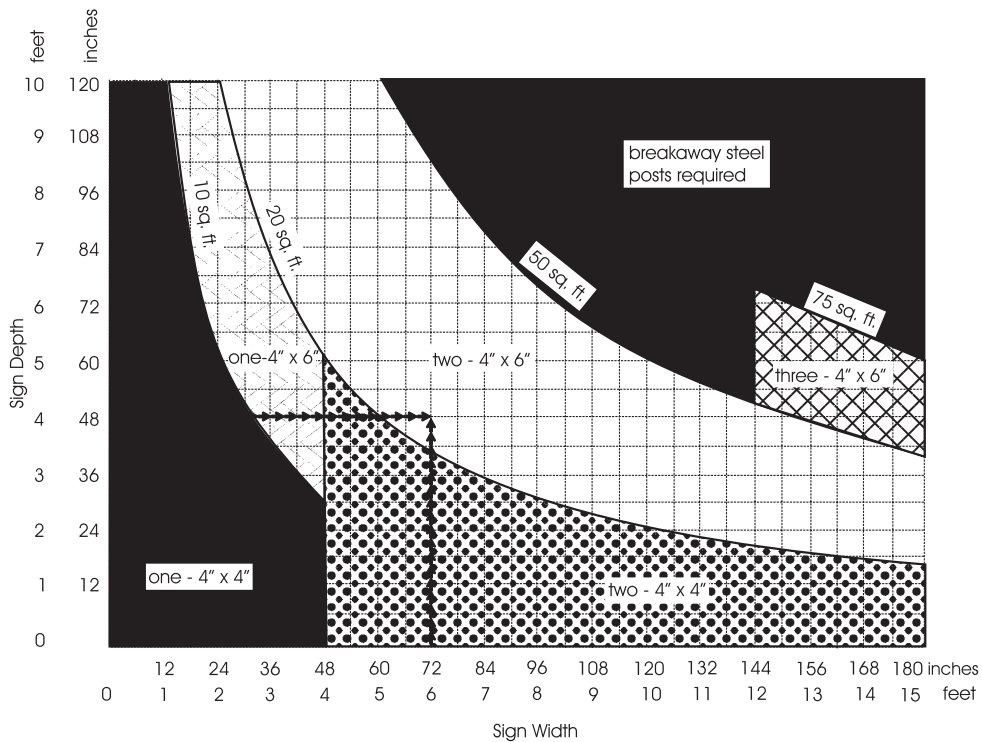

Determination of sign post size and number

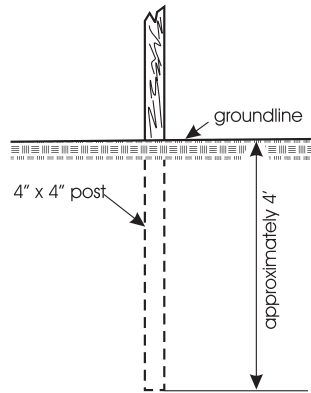

Suggested sign post installation

For stability considerations, a maximum width of 4 feet is recommended for signs to be mounted on a single post. The recommended minimum sign width for a three-post assembly is 12 feet to avoid having two posts within the path of an errant vehicle. Refer to the following diagrams for suggested two- and three-post mounting configurations.

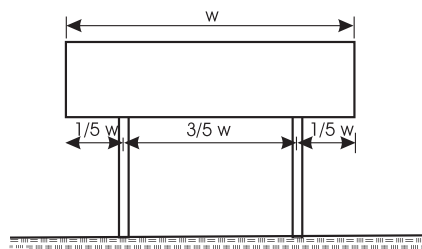

Typical two-post assembly

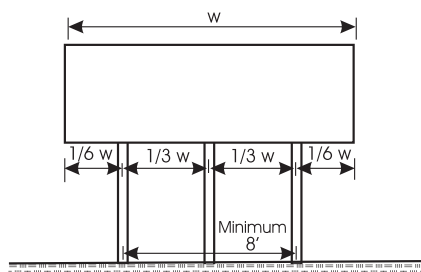

Typical three-post assembly

In special situations, wood posts may need to be spliced. Refer to the following diagram, “Post Splicing Details,” for splicing detail suggestions. Splices should be made just above the groundline to allow breakaway features to function properly. No part of the splice should be below ground elevation.

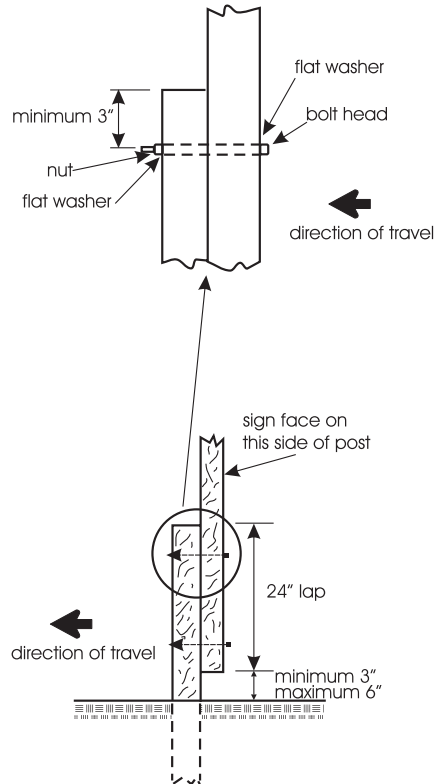

Post-splicing details

Notes:

Posts for smaller signs with less than 10 square feet of area should be installed with approximately 4 feet below the ground surface. For larger signs and longer post lengths, the portion below the ground surface should be a minimum of 5 feet. Post holes should be backfilled with suitable soil tamped in place. In cases where the soil is unsuitable, crushed rock or crushed concrete should be used. Care should be taken in the process to see that the posts are plumb, insofar as possible, at all times. If properly placed, posts should remain firmly in position without needing further attention.

All wood posts 4x6 or larger must be modified to meet breakaway requirements if located within the clear zone. This modification can be achieved by drilling two holes near the bottom of the post as shown in the following figure.

All wood posts for permanent mounting should be pressure-treated for maximum service life.

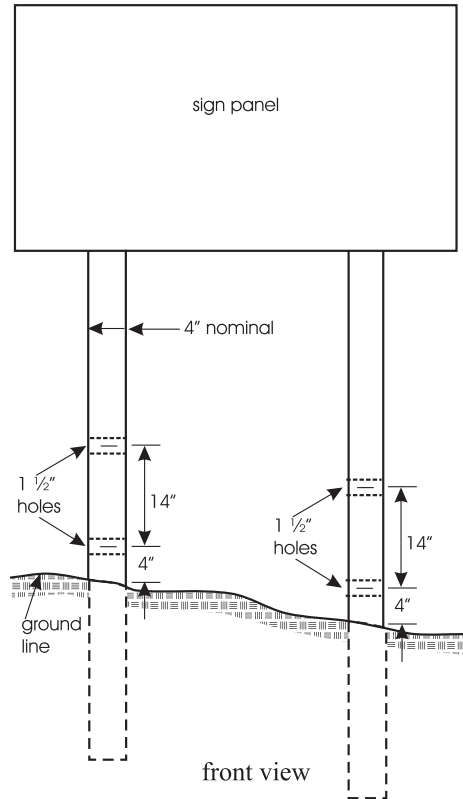

Typical modification for wood sign posts

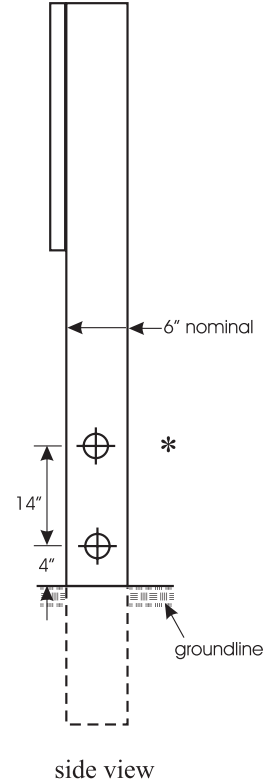

* Hole size for larger posts:
 6" x 6" - 2" diameter
 6" x 8" - 3" diameter

**Typical breakaway modification
 for wood sign posts
 (4 in. x 6 in.)**

Note:
 All 4x6 inch posts shall be modified by having two 1 1/2 inch diameter holes drilled perpendicular to the roadway center line.

Steel Posts. Steel posts for small signs are available in U-channel, round pipe, and square tube form.

U-channel posts are preferred in many cities because of the light weight, direct-driving feature, and low initial cost. U-channels generally exhibit lower loading capacities than other steel designs and do not permit signs to be mounted at right angles on a common post. Signs on U-channel posts may vibrate in the wind, causing rotation or loosening from the ground support. Use of soil-bearing plates may be necessary to stabilize some signs. These posts also can be installed back-to-back for greater stability. The posts may be spliced for more efficient use. A major manufacturer of U-channel posts is Marion Steel.



Steel U-channel post

The following posts are recommended for various sign dimensions:

<u>Sign Size</u>	<u>Post Weight</u>
18" x 24"	2 lbs./ft
30" x 30"	3 lbs./ft
36" x 48"	2 posts at 2 lbs./ft

Round pipes and newer, modified shapes have been used successfully for small sign supports in many jurisdictions. These pipes are also light and can be driven directly or placed in concrete footings. A threaded coupling also can be used as a breakaway feature and a more efficient replacement. Round pipes are somewhat more stable than U-channel posts and permit sign mounting at any angle.

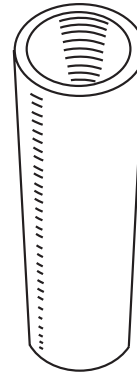

Steel pipe post

Standard galvanized, schedule 40 steel pipe is often specified. Steel posts can be driven directly into the ground to a depth of at least 3.5 feet. However, these posts may not meet current breakaway standards, and this feature should be considered before installation. Steel plates attached to the posts add stability in windy conditions. Recommended post sizes follow:

<u>Sign Size</u>	<u>Post Size</u>
30" x 30"	2" I.D.
36" x 48"	2.5" I.D.

S-Square Tube Products of Commerce City, Colorado, is one manufacturer of this type of post. An example of round pipe supports and the threaded coupling breakaway feature can be seen on the following page.

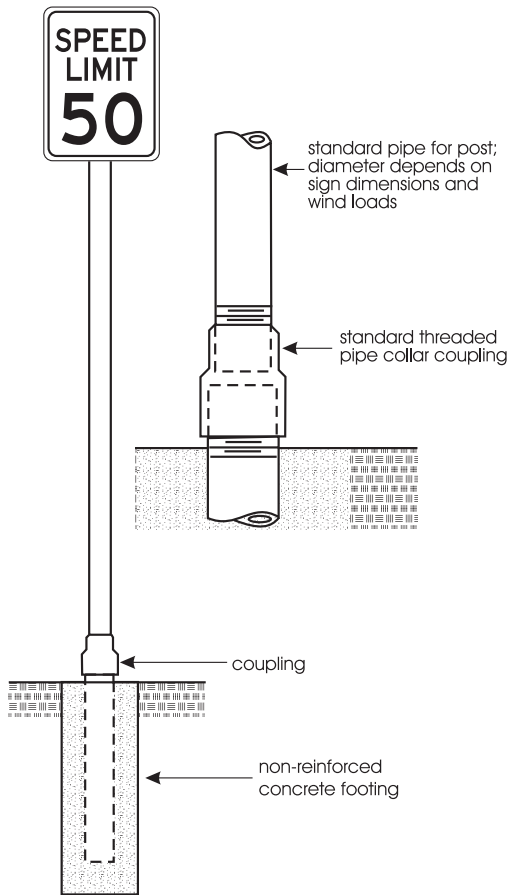

Round pipe sign support system and threaded coupling breakaway feature (inset)

Square tube posts for small sign supports are becoming more popular in both rural and urban applications. Typically, these posts are furnished with mounting holes prepunched at 1-inch spacings. Common sizes range from 1 1/2 inches to 2 1/2 inches in either 12 or 14 gauge. These supports can be driven directly or installed in a larger-sized anchor post, which makes replacement much easier. Advantages of square tube posts include flexible mounting and use options, increased strength compared to U-channel posts, option to mount on any side, and simple replacement. Damaged posts also can be recycled efficiently. Furthermore, special hard-

ware is available to increase flexibility. However, the cost of square tube posts is generally higher than U-channel. Whenever installing patented support systems, users should refer to manufacturer instructions.

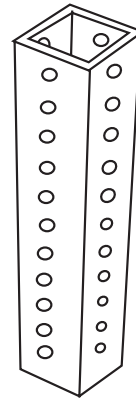

Square steel tube

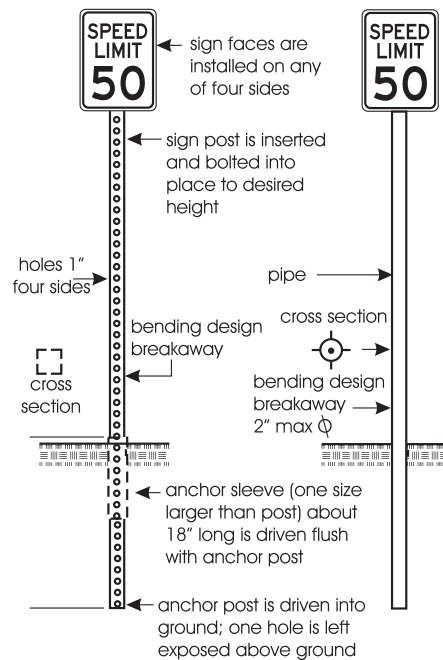

Sign support systems

The following figures and tables provide guidance in selecting post size for various sign dimensions. Additional information is available

from vendors. Major manufacturers of square tube posts include Unistrut, S-Square Tube Products, and Western Highway Products.

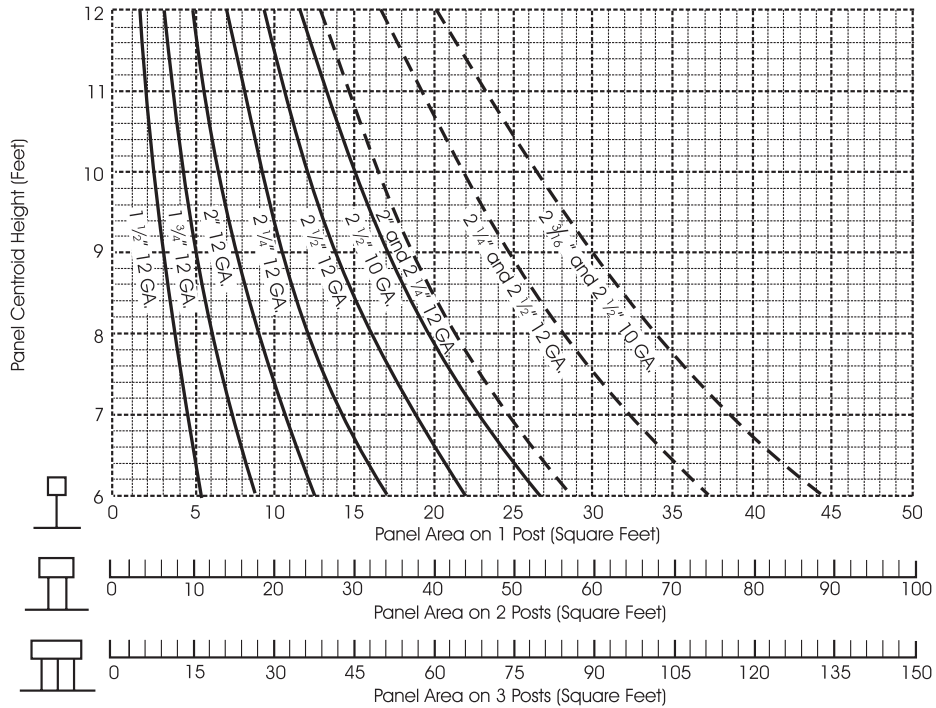

At intersection of panel area and centroid height on the chart, select post size from the line to the immediate right of the point.

Slip bases are required on the following:

- all posts with two sizes telescoped
- two-post supports 2 1/4" and larger
- all three-post supports

Lines plotted using design information in AASHTO specifications for supports for highway signs.

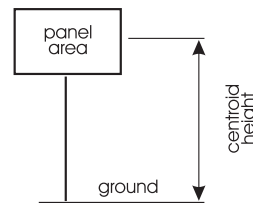

Telespar sign post chart (70 mph wind speed) for square tube posts

Source: Unistrut.

12-gauge perforated square posts¹

Sign Size (inches) Width x Height	Height to Bottom of Sign (feet)					
	5	6	7	8	9	10
12 x 12	1 1/2	1 1/2	1 1/2	1 1/2	1 1/2	1 1/2
12 x 18	1 1/2	1 1/2	1 1/2	1 1/2	1 1/2	1 1/2
12 x 24	1 1/2	1 1/2	1 1/2	1 1/2	1 1/2	1 3/4
12 x 30	1 1/2	1 1/2	1 1/2	1 1/2	1 3/4	1 3/4
12 x 36	1 1/2	1 1/2	1 1/2	1 3/4	1 3/4	1 3/4
12 x 48	1 1/2	1 3/4	1 3/4	1 3/4	2	2
18 x 12	1 1/2	1 1/2	1 1/2	1 1/2	1 1/2	1 1/2
18 x 18	1 1/2	1 1/2	1 1/2	1 1/2	1 1/2	1 3/4
18 x 24	1 1/2	1 1/2	1 1/2	1 1/2	1 3/4	1 3/4
18 x 30	1 1/2	1 1/2	1 3/4	1 3/4	1 3/4	2
18 x 36	1 1/2	1 3/4	1 3/4	2	2	2
18 x 48	1 3/4	2	2	2	2 1/4	2 1/4
24 x 12	1 1/2	1 1/2	1 1/2	1 1/2	1 1/2	1 1/2
24 x 18	1 1/2	1 1/2	1 1/2	1 1/2	1 3/4	1 3/4
24 x 24	1 1/2	1 1/2	1 3/4	1 3/4	1 3/4	2
24 x 30	1 1/2	1 3/4	1 3/4	2	2	2
24 x 36	1 3/4	1 3/4	2	2	2 1/4	2 1/4
24 x 48	2	2	2 1/4	2 1/4	2 1/2	2 1/2
30 x 12	1 1/2	1 1/2	1 1/2	1 1/2	1 1/2	1 3/4
30 x 18	1 1/2	1 1/2	1 1/2	1 3/4	1 3/4	2
30 x 24	1 1/2	1 3/4	1 3/4	1 3/4	2	2
30 x 30	1 3/4	1 3/4	2	2	2	2 1/4
30 x 36	1 3/4	2	2	2 1/4	2 1/4	2 1/2
30 x 48	2	2 1/4	2 1/4	2 1/2	2 1/2	A
36 x 12	1 1/2	1 1/2	1 1/2	1 1/2	1 3/4	1 3/4
36 x 18	1 1/2	1 3/4	1 3/4	1 3/4	2	2
36 x 24	1 3/4	1 3/4	2	2	2	2 1/4
36 x 30	1 3/4	2	2	2 1/4	2 1/4	2 1/4
36 x 36	2	2	2 1/4	2 1/4	2 1/2	2 1/2
36 x 48	2 1/4	2 1/4	2 1/2	A	A	B
42 x 12	1 1/2	1 1/2	1 1/2	1 3/4	1 3/4	1 3/4
42 x 18	1 1/2	1 3/4	1 3/4	2	2	2
42 x 24	1 3/4	2	2	2	2 1/4	2 1/4
42 x 30	2	2	2 1/4	2 1/4	2 1/2	1 1/2
42 x 36	2	2 1/4	2 1/4	2 1/2	2 1/2	A
42 x 48	2 1/4	2 1/2	A	A	B	C
48 x 12	1 1/2	1 1/2	1 3/4	1 3/4	1 3/4	2
48 x 18	1 3/4	1 3/4	1 3/4	2	2	2 1/4
48 x 24	1 3/4	2	2	2 1/4	2 1/4	2 1/2
48 x 30	2	2 1/4	2 1/4	2 1/2	2 1/2	A
48 x 36	2 1/4	2 1/4	2 1/2	2 1/2	A	A
48 x 48	2 1/2	2 1/2	A	B	C	C

Note: All posts are 12 gauge, except as noted below.

A – 2 1/2 square tube, 10 gauge perforated.

B – combine 2 and 2 1/4 tubes, 12 gauge with slip base.

C – Combine 2 1/4 and 2 1/2 tubes, 12 gauge with slip base.

D – Combine 2 3/16 and 2 1/2 tubes. 10 gauge with slip base.

Design specification: Standard specification for structural supports for highway signs, luminaires, and traffic signals.

¹Single posts; wind speed 70 mph.

Source: Unistrut.

Additional Small Sign Considerations. To save installation and material costs and to minimize sidewalk obstruction, consider alternate mounting on existing supports such as utility poles, roadway light poles, and signal poles. Overhead span wires may also be appropriate in special situations. When considering alternate mounting, bear in mind that permission from the pole owner is needed, and visibility to motorists should be paramount.

Any sign support system should be durable and structurally adequate to endure wind and ice loadings. Also look for characteristics such as relatively low material and maintenance costs, ease of installation and replacement, availability, crashworthiness, and visual aesthetics.

Large Sign Supports

Large signs (greater than approximately 50 square feet) are commonly supported with steel or aluminum posts fabricated from w-beams or s-sections and usually have several unique features. When located within the clear zone (see page C14.1 for a definition of clear zone), special breakaway designs must be used. The following figure illustrates a typical design for a large sign support. Additional advice and design information can be obtained from the Iowa Department of Transportation.

Other types of supports commonly used for large signs include cantilever and sign bridge overhead structures. Materials used for these structures include tapered steel tube, single steel tube and truss construction. Aluminum is another popular construction material.

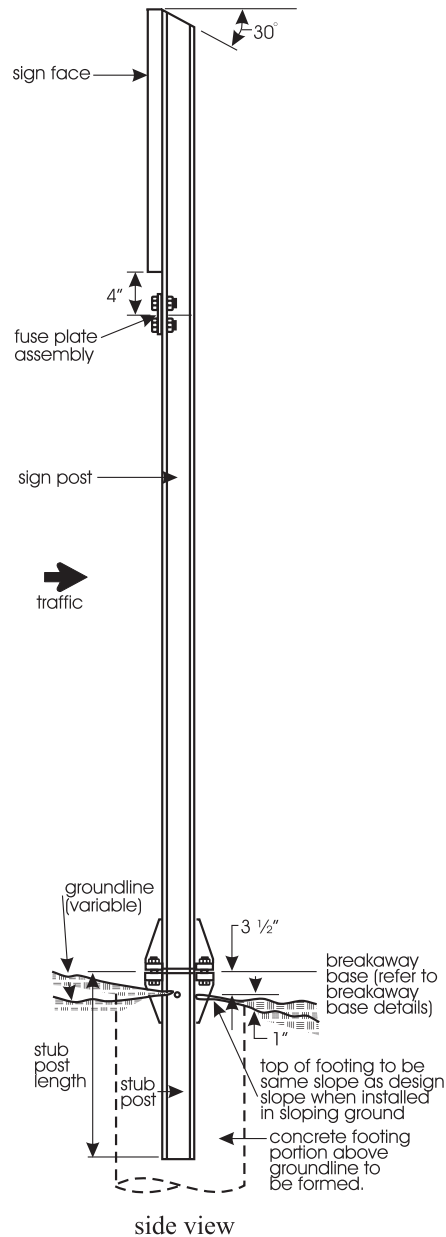

Typical sign installation

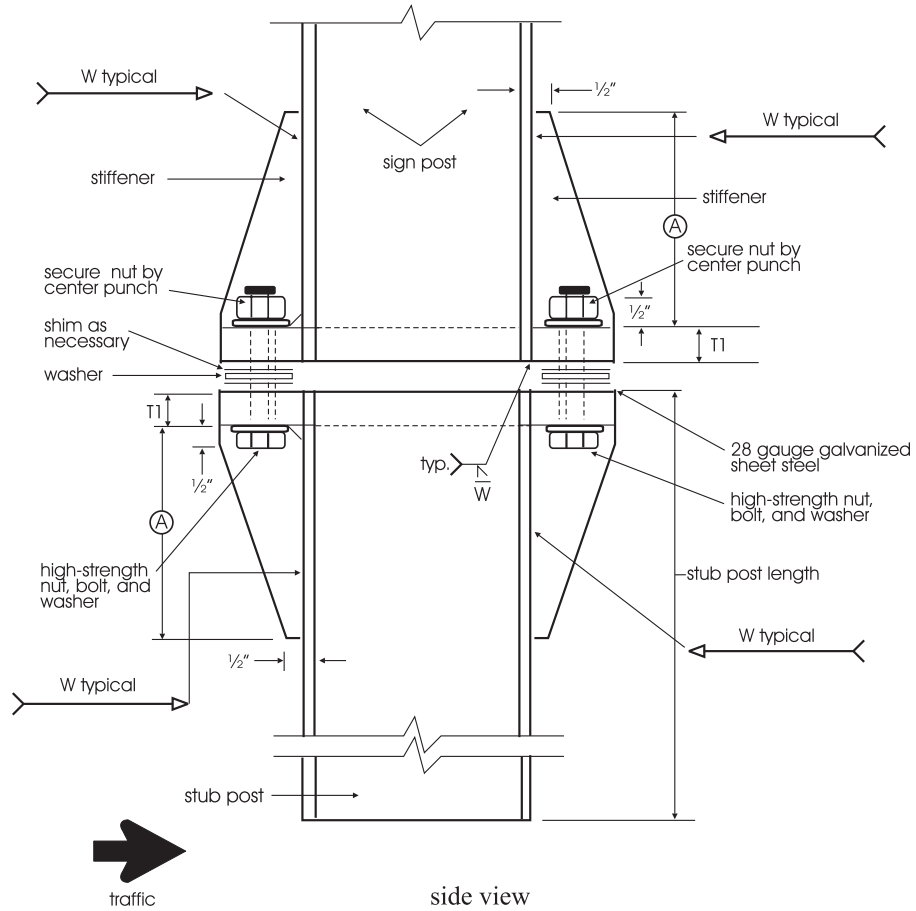

(W) welds shall be continuous fillet welds and of a depth equal to the thickness of the flange for the post unless otherwise specified

Breakaway Base Data				
Post Size	Bolt Size and Torque	(A)	(T)	(W)
W 6 x 9	5/8" dia. x 2 3/4" Torque = 37 1/2' lbs.	5"	3/4"	1/4"
W 6 x 12				
W 6 x 15				
W 8 x 18				
W 8 x 21	3/4" dia. x 3 1/2" Torque = 62 1/2' lbs.	6"	1"	5/16"
W 10 x 22				
W 10 x 26				
W 12 x 26				

Breakaway base details

Chapter 5

Catalog

Entrance Signs, Footboard, and Welcome Signs

Our entrances are the first impression a visitor has of Service lands. They provide basic information for visitors. We use entrance signs and welcome signs to identify Service lands at the primary entrance. We place them at major public entrance roads on all refuges, fish hatcheries, research facilities, and other appropriate sites.

An entrance sign may also be part of a larger objective of welcoming and informing visitors. Primary entrances should include the following signs:

- Standard 4' × 8' entrance sign, optional footboard,
- Hours of operation,
- A 3' × 6' welcome sign, and
- An activities sign.

Fee information may be applicable. As all entrances differ, unique situations call for unique signs. Contact your Regional Sign Coordinator to discuss your options.

Description

The standard Service entrance sign is manufactured in 5/8" high density overlay plywood (HDO) or other suitable substrates. Aluminum, poly-metal, dimensional lumber, high density sign foam, or recycled plastics may be used. To determine which substrate to use, consider the purchase and maintenance costs, suitability to a given climate, appearance, and political appropriateness of the medium for the area (e.g., using redwood when spotted owl populations are declining may not be wise). If you use dimensional lumber, high density foam, or recycled plastics, the sign may be either routed or sandblasted. If you use HDO, aluminum, or poly-metal, the face of the sign will be covered with 3M Engineer Grade Prismatic (EGP) #3430 Series or 3M High Intensity Prismatic (HIP) #3900 Series vinyl sheeting with reflective white letters.

The standard colors are either PMS coated colors (screen print signs) or CMYK and RGB colors (digital print signs) with matching footboards. There are three color choices, each reflecting the environ of the station. The colors are standard brown background, desert/prairie tan background, and coastal white:

- *Standard brown* – background (PMS 469C) with white letters (EGP vinyl 3430# or HIP vinyl 3930#).
- *Coastal colors* – white/grey background (EGP vinyl 3430# or HIP vinyl 3930#) with blue letters (PMS Reflex Blue C).
- *Desert/prairie colors* – beige background (PMS 468C printed on EGP vinyl 3430# or HIP vinyl 3930# with brown letters).

Design Standards:

- There are three sizes of entrance signs: 2' × 4', 4' × 8', and 5' × 10'. Many vendors feel the 5' × 10' size is no longer feasible or cost-effective. You can put two HDO boards 30" × 120" together to create a 5' × 10", and the station staff will have to cleat the back of sign together.
- Standard rounded corners are 3" in radius on 4' × 8' and 5' × 10' with a 2" radius rounded corner on the 2' × 4'.
- We use footboards to convey a secondary message, and they may accompany entrance signs. Footboards have radius corners to match the entrance sign.
- Entrance signs may be horizontal or vertical.

- Text hierarchy is site name (largest), followed by type of Service land (refuge, hatchery, etc.), U.S. Fish and Wildlife Service, Department of the Interior.
- The blue goose is the primary design element for refuges, the jumping fish for hatcheries, and the Service emblem for all other Service sites. The Service emblem is the secondary design element when a primary design identifier exists, such as, the Department's shield.
- A welcome sign is 3' x 6' and we use them at the entrance sign locations. These signs have square corners 1/2" border with 2" radius corners to the edge.

Text, Graphics:

- Entrance signs have text and blue goose inlay with white reflective borders that are vinyl and an appropriate color.
- Swiss 721 BT Bold condensed font for all text except USFWS.
- American Typewriter ITC BT Medium font 10% slant for USFWS text.
- Emblem sizes (height) are the following: 4" (2' x 4'), 8" (4' x 8'), 12" (5' x 10').
- Blue goose reflective PMS Blue 288C: 6" x 12" (2' x 4'), 12" x 24" (4' x 8'), 12" x 30" (5' x 10').
- Footboards to match entrance sign's font.
- Welcome sign font is Helvetica bold, blue goose size is 12.75" x 30".

1-Line 4 x 8 Entrance Sign Text and Graphic Element Sizes



1-Line 4 x 8 Entrance Sign Measurements (from the bottom and left)

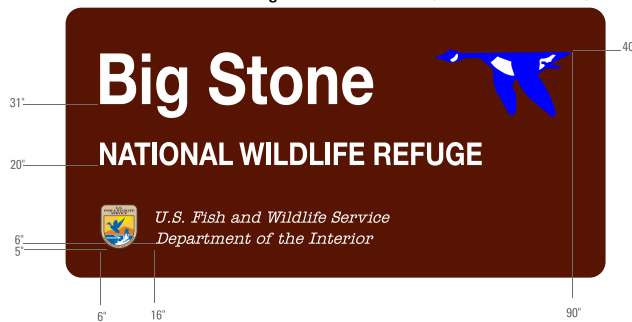

1-Line Short Name 4 x 8 Entrance Sign Measurements (from the bottom and left)



Entrance Sign Guidance

- Most sites can use the 4' × 8' horizontal entrance sign. In certain situations, such as land ownership restrictions, lay of the land, traffic engineering restrictions, or a lack of available space prohibits the erection of the monolith or H frame, you must get approval from your Regional Sign Coordinator and the Regional Director to use another configuration or mounting scheme.
- The site name is used on entrance signs. Complex names are reserved for administrative purposes and should not appear on entrance signs. Units should use a footboard for the unit or division name under the primary entrance sign.
- Locate the entrance sign as close as possible to the intersection of the site driveway and the highway or main road. *Manual for Uniform Traffic Control Devices* rules for signs along highways apply. Install it on either a stone base or H-form stanchion, and you may use native materials. You can plant well-maintained native flowering plants around the entrance sign as long as they do not obscure or detract from the sign and its visibility.
- You may have to use breakaway elements if the entrance sign is erected within 6' of the roadway and supported on 6" × 6" or larger posts.
- Provisions for 9-1-1 Emergency Location Information:

The emergency location address is maintained in the 9-1-1 system. Some jurisdictions require you to post the 9-1-1 address at the entrance or on a building. Consult with your emergency communications office for posting requirements. These numbers, including road names, may be posted on a placard on the entrance gate or on your entrance sign post using a footboard for the 4' × 8' and 2' × 4' configurations.

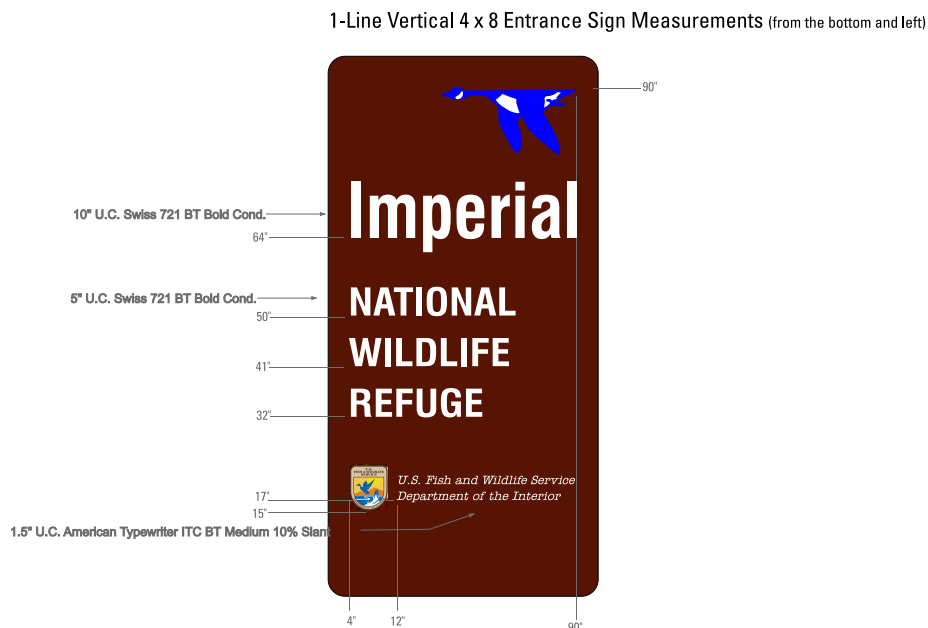

Welcome and Secondary Entrance Sign Guidance

- Locate the welcome sign after the initial entrance, so that visitors will already know the site name and the basic information before they see the welcome.
- Secondary entrances are those where a visitor may enter Service lands that are different from the primary entrance. These entrances should include a 2' × 4' entrance sign identical to a primary entrance sign along with the other signs identified for primary entrances. Depending on the site, you may have an hours and activities sign for a secondary entrance different from the primary entrance due to unique activities or opportunities at that location.
- Facility identification signs are used at visitor centers, contact stations, and other Service offices. If a facility identification sign needs to be attached to the building, place it on the latch side of the door. We suggest a mounting height of 54 inches.

Where appropriate, visitor facilities may incorporate facility signage with landscaping. These signs should include signature elements of our standard entrance sign and complement the facility's color scheme or other design features.

Visit the [Access Board guidelines on signs](#) for additional information.

Installation and Mounting

Clearance

For the safety of motorists, place entrance signs as far from the road as practical. Twelve feet from the edge of the traveled way is the minimum distance allowed in most instances.

Normally you should post signs so the lower edge is 5' above ground level. Where the sign might be blocked from view, you may post it up to 7' above the level of the ground.

Posts

The standard base for entrance signs consist of CCA-treated wood posts, but bases and skirts may be constructed of other materials such as brick, fieldstone, masonry, or wood. Greener alternatives to CCA posts may be available locally, such as alkaline copper quaternary (ACQ). Signs placed within 30 feet of a public roadway should conform to the breakaway specifications described on [page 5-5](#).

Mount entrance signs using a 1/4" aluminum angle, attached to the sign back with #10 × 7/8" maximum stainless steel sheet metal screws spaced 6" on center. A 6" × 6" CCA-treated wood post, number 2 or better, well-seasoned and free of defects, is standard. Greener alternatives to CCA posts may be available locally, such as alkaline copper quaternary (ACQ).

Ordering

Order Service entrance signs through your Regional Sign Coordinator, using the Sign Order Form.

The signs shown on previous page are suitable for most Service facilities. A Project Leader may order custom entrance signs by obtaining, in writing, concurrence from his/her/their supervisor, the Regional Sign Coordinator, and the Regional Director.



USFWS Vinyl Specs- HIP High Intensity Prismatic
Sign Background: Reflective Brown 3M 3933/PMS 489C
Blue Goose: Reflective Blue 3M 3935/PMS 288C
All Text: Reflective White 3M 3930
USFWS Emblem: Reflective
NOTE: Edges and Backs Painted to Match Brown HDU Pilewood Signs

Ready Reference Guide to Area Management Signs

	Boundary Signs	Designated Area Signs
Use	<p>Mark boundaries at:</p> <ul style="list-style-type: none"> ■ Research areas ■ National Fish Hatcheries (A-1) ■ National Wildlife Refuges (A-2) ■ Waterfowl Production Areas (A-3) ■ Conservation easements (A-18) ■ Other Service lands 	<p>Mark:</p> <ul style="list-style-type: none"> ■ Areas designated for special use ■ Areas where specific activities are permitted/prohibited ■ Significant projects of the Youth Conservation Corps
Description	<p>Aluminum (0.063 with 1" Radius corners) or poly-metal 3mm, non-reflective</p> <p>11" × 14' signs have mounting holes predrilled, 3/8" diameter, 12" on center.</p> <p>May be screen printed or digitally printed signs. Screen printed signs last longer (7–10 years) and are used when ordering higher quantities. Digitally printed signs with lamination don't last as long (3–5 years) and are used when you're ordering fewer signs or signs for short-term use.</p>	
Placement	<p>Place on boundary lines so they are visible from one to another, no more than 1/8-mile (660 feet) apart.</p> <p>Corners and entry points should be clearly marked with two signs.</p> <p>When used with another sign, place boundary marker above other sign.</p> <p>When placed along public roads, (County or State) place on the right of way or easement line. If the signs would not be visible, obtain permission from the road agency to place them closer.</p>	<p>Place so they are visible from one to another, no more than 1/8-mile (660 feet) apart where necessary to:</p> <ul style="list-style-type: none"> ■ Identify areas designated for special uses. ■ Inform visitors of permitted and prohibited activities or special regulations in effect. <p>When placed at a boundary, post the designated area sign below the boundary sign.</p>
Mounting and Installation	<p>Generally, mount A-series on U-channel posts. You may use in some situations other approved materials in remote areas where there is little public use or when replacing a sign that was on a metal post that was in good condition.</p> <p>Mount so lower edge is 5 feet above ground level.</p> <p>Mount using vandal-resistant hardware.</p> <p>When installing within 30 feet of public access roads, mount on breakaway posts unless the sign is protected by a guardrail or topographic change. (Wood 4' × 4' posts and standard U-channel steel posts do not require breakaway treatment.)</p>	
Ordering	<p>Order from UNICOR or an approved sign vendor. Send the signed order form to your Regional Sign Coordinator for approval unless you have authorization to order directly.</p>	
Maintenance	<p>Clean and inspect regularly.</p> <p>Wash with a mild, biodegradable detergent and water solution.</p> <p>Replace damaged signs.</p>	

Area Management Signs

Area management signs are designed to facilitate management of Service lands and assist in enforcing regulations. They mark boundaries, identify special areas or functions of specific areas, and describe permitted and prohibited activities.

Description

Area management signs are aluminum or poly-metal, non-reflective signs. They have a white vinyl background. Most area management signs measure 11"×14". The 11"×14" signs have mounting holes predrilled 3/8" in diameter, 12 inches apart and a 1" radius rounded corner. Area management signs are standard signs and cannot be altered. Use the Service code number when ordering. Custom area management signs may not match the look of a standard area management sign. Custom sign must be brown with white letters. Custom is defined as specific to a site or sites but not universal to all Service lands.

Installation and Mounting

Clearance

For the safety of motorists, place area management signs posted along public access roads as far from the road as practical. Twelve feet from the edge of the traveled way is the minimum distance allowable in most instances.

Normally you should post signs so the lower edge is 5 feet above ground level. Where the sign might be blocked from view (by pedestrians, for instance), it should be 7 feet above ground level. Where two signs are mounted on one post, the bottom of the lower sign may be lower than 5 feet.

Posts

Generally, you should mount area management signs using vandal-resistant hardware on wood posts. A 4"×4" CCA-treated wood post, number 2 or better, well-seasoned and free of defects, is standard. Greener alternatives to CCA posts may be available locally, such as alkaline copper quaternary (ACQ). However, metal posts are acceptable in the following instances:

- Remote areas not generally visited by the public, such as boundary signs.
- Replacement of a sign previously mounted on a metal post when the post is still in good condition.
- Raptors have been known to get toes wedged into the top hole of pre-drilled steel and U-channel posts, resulting in injury and death. When using these posts, fill the top hole.

If you use metal posts within 30 feet of a public access road, they should have a breakaway design. The standard wood 4"×4" post, standard U-channel, and 2" tubular metal posts are small enough not to require breakaway design.

Ordering

In accordance with [Title 18, United States Code, Section 4124](#) and [FAR Part 8.6](#), you must buy area management signs from UNICOR or another approved sign vendor. They can be ordered using the Service sign code number. Send orders to your Regional Sign Coordinator.

Regional Sign Coordinators may, at their discretion, waive the requirement for Regional approval and authorize field station managers to submit their purchase orders for area management signs directly to UNICOR or other approved sign vendors.

Maintenance

Cleaning and Repair

Clean and inspect area management signs regularly. They can be washed with a mild, biodegradable detergent and water solution. Cleaners with solvents or abrasives may damage the background, so do not use them. When area management signs are damaged, it is usually more cost-effective to replace them than to repair them.

Replacement

Visibility is a consideration in deciding whether to replace a sign. In remote areas, away from general public view, signs can be left in place as long as they are fulfilling their purpose. You can overlook minor damage or rust as long as the sign is fully legible and intact. In public use areas, replace signs if their overall appearance does not convey a positive image of the Service. More information on sign maintenance can be found in [Chapter 4](#). Information on the uses, colors, and special considerations relating to the different area management signs is found on the following pages.

A-Series Signs

Uniformity and consistency are main goals for A-series signs on all Service lands. The Service 11" × 14" A-Series signs are usually screen-printed so they are cost-effective and last longer. These signs are not reflective, so when they are damaged or worn, they are recyclable.

Description:

- 11" × 14" aluminum
- .063 gauge thickness
- 3/8" holes (2) 12" on center
- 1" radius corners
- White sign face

Standard Ink Colors for 11" × 14" A-Series signs

- Dark Blue PMS (288C)
- Dark Green PMS (3308C) Waterfowl Production Area boundary signs
- Black – Alaska boundary sign only

Text, Graphics:

- Text Helvetica bold main copy.
- Helvetica medium condensed can be used to accommodate smaller text USFWS.
- Text should be no smaller than ¼" high using upper and lower-case letters.
- Graphics: Blue goose size 3" × 6.50" or USFWS 4.50" size emblem.

Design Standards:

- Follow *MUTCD* standards for sign placement.
- Follow the requirements in this handbook.
- You can purchase a small number of signs that are personalized with a refuge telephone number.

Standard A-Series Signs



Boundary Signs

Boundary posting is carried out under the oversight of the Regional Land Surveyor in accordance with [343 FW 1 and 2](#), and the [Land Survey Handbook](#) Chapter 7. Consult with the Regional Land Surveyor on all boundary posting projects.

Guidance

Install all boundary signs on boundary lines so they are visible from one to another or at intervals no greater than 1/8-mile (660 feet).

Clearly mark entry points and sharp boundary corners with two signs, one facing each direction, within 3 to 10 feet of the corner. For more details see the [Land Survey Handbook](#) Chapter 7.

Never place boundary signs under other signs. If another sign is needed at a boundary (area closed, public hunting area, etc.), place it below the boundary sign with a 1" space between the signs. No more than *two* signs should be placed on a post.

Posting A-Series Signs

Use steel mounting posts or U-channel posts to post A-Series signs. Avoid using trees except in the case of a boundary line tree (see [Land Survey Handbook](#)) and never mount the sign to a power or telephone pole. Mounting to steel posts ensures proper mounting height, uniformity of distances between signs, and a longer life for the sign.

Tips

- Raptors have been known to get toes wedged into the top hole of pre-drilled steel and U-channel posts, resulting in injury and death. When using these posts, fill the top hole.

You can find more information about boundary signs on the following pages of this handbook:

- Mounting, [page 3-4](#)
- Ordering, [page 3-1](#)

Information on each specific type of boundary sign can be found on the following pages.

Types of Boundary Signs

U.S. Fish and Wildlife Service Boundary Sign (FWS-A-1)

U.S. Fish and Wildlife Service boundary signs are used to mark the boundaries of research areas, fish hatcheries, and Alaska national wildlife refuges. These signs are black and white, and are also available in Spanish.

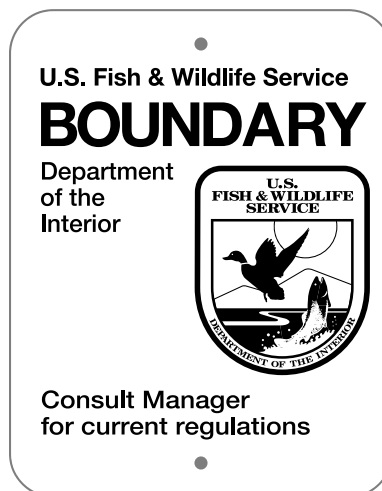

FWS A-1

National Wildlife Refuge Boundary Sign (FWS-A-2, A-2A, A-2B, Spanish)

We use National Wildlife Refuge boundary signs to mark the boundaries of all national wildlife refuges except those in Alaska. Those carry the message that unauthorized entry is prohibited, which is not applicable for Alaskan refuges since their boundaries have been legally designated as open. A-series signs are blue (PMS 288C) and white. A Spanish language version of this sign is available. FWS-A-2A-C signs also provide alternative methods to mark a boundary. Consult your Regional Sign Coordinator for guidance on the use of these signs.

- (A-2) *Unauthorized Entry Prohibited* – Use this sign where most activities are not allowed.
- (A-2A) *Boundary* – Use this sign where most activities are allowed.
- (A-2B) *Boundary* – Consult Staff for Regulations. Use this sign where activities are allowed, but where visitors should contact staff for a complete list of regulations.

Refuge managers should use good judgment when placing boundary signs. For example, boundary signs with “Unauthorized Entry Prohibited” should not be placed directly adjacent to trail heads or entrances to boardwalks.

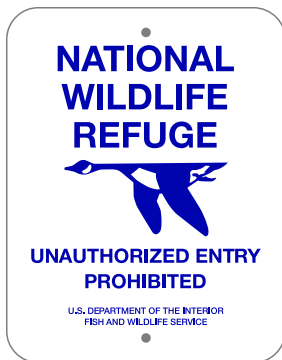

FWS A-2

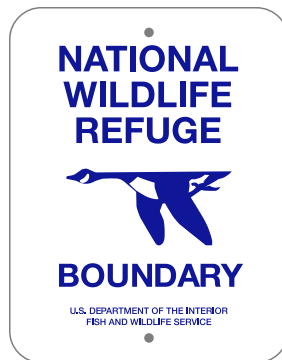

FWS A-2A

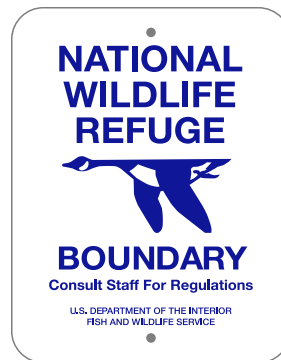

FWS A-2B

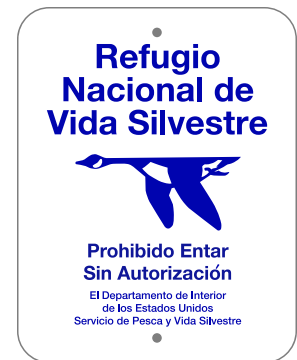

Spanish

Waterfowl Production Area Boundary Sign FWS-A (A-3A, A-3B, A-3C, and A-3D)

Waterfowl Production Area boundary signs mark the boundaries of areas that have been legally designated as Waterfowl Production Areas. These signs are green (PMS 3308C) and white.

- (A-3A) *Unauthorized Activities Prohibited* – Use this where vehicles are allowed, but most other activities, other than hunting, are not allowed.
- (A-3B) *Unauthorized Entry Prohibited NO VEHICLES* – Use this sign where vehicles are not allowed, and most other activities, other than hunting, are not allowed.
- (A-3C) *Purchased with Duck Stamp Dollars* – Use this sign where vehicles are allowed and other uses are also allowed.
- (A-3D) *NO VEHICLES Purchased with Duck Stamp Dollars* – Use this sign where vehicles are not allowed, but other uses are allowed.



FWS A-3A



FWS A-3B



FWS A-3C



FWS A-3D

Conservation Easement Boundary Sign (FWS-A-18)

Conservation Easement boundary signs mark the boundaries of conservation easements. They should be used alone where there is no management interest acquired under the easement.

For those easements where there is a need to inform the public (e.g., the area is open/closed to hunting), you will have to use additional existing standard signs and posts. These signs are 3" x 4½" with blue ink (PMS 288C) on white background with radius corners and holes.



FWS A-18

Designated Area Signs

Guidance

Install designated area signs so they are visible from one to another, no more than 1/8 mile apart where appropriate to:

- Identify areas designated for special use.
- Inform visitors of permitted and prohibited activities or special regulations in effect.
- Advise of the necessity to consult the manager for further information.
- Mark significant projects of the Youth Conservation Corps.
- Mark fee areas with "Your Fee Dollars at Work" signs.

Where a designated area sign is used at a boundary, it is supplementary to the boundary sign and posted 1 inch below it. Do not place more than two signs on one post.

You can find more information about designated area signs on the following pages of this handbook:

- Mounting, [page 3-4](#)
- Ordering, [page 3-1](#)
- Maintenance, [Chapter 4](#)

Types of Designated Area Signs

Public Fishing Area Sign (FWS-A-4)

Use Public Fishing Area signs to inform the public that limited sport fishing is permitted in the designated area.

Public Hunting Area Sign (FWS-A-5)

Use Public Hunting Area signs to inform the public that limited sport hunting is permitted in the designated area.

Area Beyond This Sign Closed Sign (FWS-A-6)

Use Area Closed signs to inform the public that the designated area is closed to all entry.



FWS A-4



FWS A-5



FWS A-6

Area Closed To Pursuing, Hunting Migratory Birds Sign (FWS-A-7)

Use Area Closed to Hunting Migratory Birds signs in areas designated by Presidential Proclamation or Executive Order as being closed to migratory bird hunting, primarily when those areas fall within national wildlife refuge boundaries. These areas are listed in [Title 50](#) of the Code of Federal Regulations, Subsection 32.8, which is cited on the sign. These designated areas (lands and waters) may be located within, adjacent to, or in the vicinity of a national wildlife refuge. Do not use these signs in areas other than those listed in the regulations. In addition, these signs cannot be posted on non-Service lands without a formal agreement between the Service and the rightful property owner(s).

Notice-Government Property Sign (FWS-A-8)

Use Notice-Government Property signs to identify select Government property (outbuildings, maintenance sheds, etc.) and to inform the public that no trespassing is allowed in the designated area.

No Hunting Zone Sign (FWS-A-9)

Use No Hunting Zone signs to inform the public that no hunting is permitted in the designated area. We use these signs for safety purposes and may post them around hunter check stations, hunter parking areas, and other areas within a designated hunting area. They may also be posted along fish hatchery boundaries if hunting pressures are significant and hunter trespassing has been a problem.

Pheasant Hunting Only Sign (FWS-A-10)

Use Pheasant Hunting Only to inform the public that *only* pheasant hunting is permitted in the designated area.

Waterfowl Hunting Only Sign (FWS-A-11)

Use Waterfowl Hunting Only signs to inform the public that *only* waterfowl hunting is permitted in the designated area.

Spaced Blind Area Sign (FWS-A-12)

Use Spaced Blind Area signs to inform the public that the hunting area is restricted and that hunters are assigned to sites.

Nontoxic Shot Zone Sign (FWS-A-13)

Use this sign to inform the public that nontoxic shot ammunition is required in the designated hunting area.



FWS A-7



FWS A-8



FWS A-9



FWS A-10



FWS A-11



FWS A-12

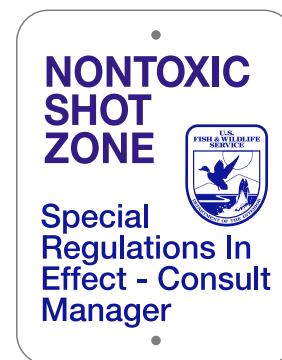

FWS A-13

National Wilderness Area Sign (FWS-A-14)

Use National Wilderness Area signs to inform the public that the area has been designated by Congress as a National Wilderness Area.

National Wild and Scenic River System Sign (FWS-A-15)

Use National Wild and Scenic River System signs to inform the public that the area has been designated by Congress as part of the National Wild and Scenic River System.

Youth Conservation Corps (date) Sign (FWS-A-16)

Use Youth Conservation Corps signs to identify significant Youth Conservation Corps projects and the year of their completion.

Archaeological Site Sign (FWS-A-17)

Use Archaeological Site signs to mark archaeological sites that are protected by regulations.

When making decisions about the placement of this sign, field station managers should consider such factors as the public visibility of the site and the sensitivity of its cultural values. Placing signs in areas with some types of archaeological sites may result in unnecessary recognition, which could lead to vandalism or unauthorized removal of artifacts. In these instances, it may be better to post a Notice–Government Property sign (FWS-A-8) at the site.

There may be situations where protecting historic structures by using a Notice–Government Property sign is more appropriate. We encourage field station managers to discuss the use and placement of signs with the Regional or local historic preservation officer to ensure maximum site protection. Refer to the Cultural Resource Management chapter of the Service Manual ([614 FW 1](#)) for more information on the use of signs as protective measures.

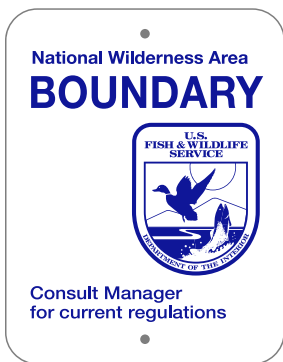

FWS A-14



FWS A-15



FWS A-16

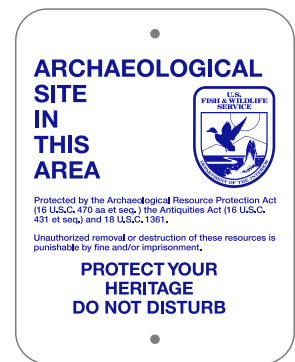

FWS A-17



Other Area Management Signs (FWS-A-19 – FWS-A-24)

The following are other area management signs:

- *100 Year Flood Level (FWS A-19)* – Standard 11" × 14" blue (PMS 288C) and white sign.
- *Flood of Record (FWS A-20)* – Standard 11" × 14" blue (PMS 288C) and white sign.
- *Your Duck Stamp Dollars at Work recognition sign* – 22" × 28", .080 gauge aluminum, tan background, brown text.
- *Buckle Up* – 12" × 18", .063 gauge aluminum, red text.
- *Schoolyard Habitat Program* – Designates a wildlife habitat built at a school with assistance from the Service



FWS A-19



FWS A-20

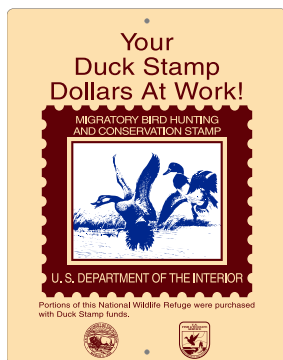

FWS A-21

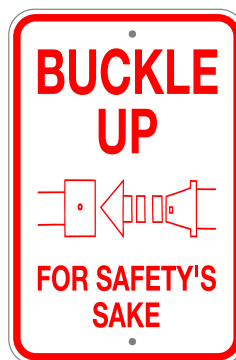

FWS A-22

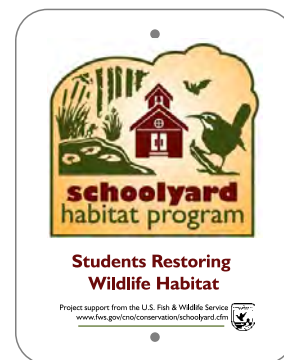

Other Site-Specific Signs

These signs inform visitors of wildlife management activities and any site-specific regulations or information. They include temporary and permanent signs relating to beach closures, prescribed burns in progress, hunts in progress, and other management activities. Since these signs and their placement are unique, you must seek approval for the sign from the Regional Sign Coordinator.

- *Trapping* – Standard 11" × 14" blue (PMS 288C) and white sign. This sign must be posted at units of the National Wildlife Refuge System (NWRS) where trapping occurs.

Refuges must post this sign in a public area of the refuge to inform visitors of the potential for trapping activities. The exact location is at the discretion of the Refuge Manager and is to be in a location that best serves the public at the refuge. Trapping activities covered include the use of leg-hold traps, Conibears, and snares. Mist nets, rocket nets, live traps, fish traps and research trapping are not included.

- *Drones Prohibited* – Standard 11" × 14" blue (PMS 288C) and white sign.



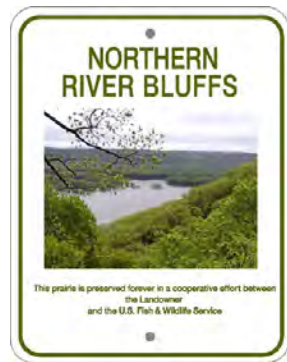
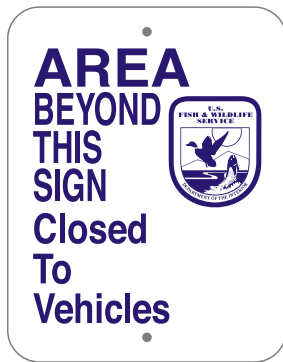

11 x 14 digital print large logo and multiple graphics

11 x 14 digital print and text combination



11 x 14 screenprinted text and graphics on white background

12 x 18 screenprinted and vinyl cut text vinyl background

Ready Reference Guide to Information Signs

	General Information	Concession Area	Building Identification
Use	Inform visitors of: <ul style="list-style-type: none"> ■ Opportunities ■ Services ■ Regulations 	Identify concession operations and provide information on: <ul style="list-style-type: none"> ■ Goods and services ■ Rates or fees ■ Hours of operation 	Identify buildings and sometimes show their hours of operation
Sheeting Type & Description	EGP (Engineer Grade Prismatic) <ul style="list-style-type: none"> ■ 3M series, 3430 ■ Type I, Reflective ■ Off-road signage, parking lots, etc. 	HIP (High Intensity Prismatic) <ul style="list-style-type: none"> ■ 3M series, 3930 ■ Type IV, Reflective ■ Roads, traffic control signs 	
Description	HDO-plywood substrate, aluminum, or poly-metal covered with reflectorized vinyl 3M EGP or 3M HIP sheeting. White letters on brown reflective background or non-reflective for non-roads signs.		
Design Standards	<p>Sign size and letter height are determined by whether the sign is for motorist or pedestrian viewing and viewing distance.</p> <p>Letter type is Helvetica bold.</p> <p>U.S. Fee Area Symbol is used when appropriate.</p> <p>Messages generally have flush left margins, but may be centered when appropriate.</p> <p>No more than 4 messages per sign.</p> <p>Signs should not be placed where they will create distractions, obstructions, or hazards.</p>		
Placement	Signs posted along public access roads should generally be at least 12' from the edge of the traveled way. Follow <i>MUTCD</i> guidelines when posting these exterior wall signs for motorist viewing.	Place at eye level on front or along building's approach walk.	
Mounting and Installation	Signs posted for motorist viewing should be mounted 5' above the level of the road. Mount most information signs on standard 4" × 4" or 4" × 6" posts. Mount using vandal-resistant hardware. If you use posts that are larger than our standards for signs viewed by motorists, they must be of breakaway design unless the sign is protected by a guardrail or topographic change.	If wall-mounted, use rust-proof hardware appropriate to building materials. If post-mounted, use vandal-resistant hardware.	
Ordering	Order from UNICOR or another approved sign vendor, using the Service Sign Order Form (FWS Form 3-2040).		
Maintenance	<p>Inspect and clean regularly.</p> <p>Wash with a mild, biodegradable detergent and water solution.</p> <p>For vandalized or damaged signs, weigh the cost of repair in time and materials against the cost of a replacement sign.</p> <p>Replace badly damaged signs.</p>		

Information Signs

Information signs inform visitors of services, opportunities, and regulations at the station.

Field stations may not make information signs.

This section of the handbook is divided into four parts:

- General information signs
- Welcome and orient signs
- Concession area signs
- Building designation signs

Design standards apply to the size and layout of general information, welcome and orient, and concession area signs. Sign size varies according to the size of the letters and the amount of text. If the sign will be read from moving vehicles, letter size is determined by traffic speed on the road where the sign is posted or the distance from which it will be viewed. Helvetica bold is the letter style, and both upper and lower-case letters are used. Signs intended for pedestrian viewing use smaller lettering and are generally smaller in size.

Description:

- High Density Overlay 5/8" Plywood (HDO).
- Aluminum .063 gauge under 3 feet in length and .080 gauge over 3 feet in sign length.
- Poly-metal 3mm thickness under 3 feet in length and 6mm thickness over 3 feet in sign length.
- The sign face is vinyl reflective sheeting with brown background (PMS 469C).
- Signs have a ½" reflective border out to the sign edge, and 2" radius reflective corners in the white.
- Text is white.
- Helvetica bold is the font for primary copy, using upper and lower-case letters.
- Helvetica medium is the font for secondary copy, using upper and lower-case letters.
- Arrows cut to Service specs and generally the same height as the capital letter height. Arrows must be used on all U.S. Fish and Wildlife Service signs in the guide category when required to indicate direction. Arrows are available in sizes corresponding to letter height, but final decisions are left up to authorized vendors for precise size of arrow on sign layout.
- Only Federal recreation symbols should be used to indicate recreation areas.
- Descriptive text accompanies universal symbols.



Design Standards:

- *MUTCD* design requires that signs viewed from roads open to the public meet the following requirements:
 - Features such as size, contrast, colors, shape, composition, and reflectorization should work together to draw attention to the sign.
 - Shape, size, colors, and simplicity of message should work together to produce a clear meaning.
 - Legibility and size should work with placement to permit adequate time for response.
 - Uniformity, size, legibility, and message should work together to command respect.
- Follow the requirements in this handbook.
- Signs should contain only essential information, brief and simple.
- Sign size and letter height are determined by viewing distance for either motorists or pedestrians.
- Sign size may be limited and stated for a specific size substrate (36"×48") with letters to fit.

Usually, the overall size of a sign is determined by the manufacturer unless there is a particular reason for the station to determine it. For instance, if there is minimum space for the sign or if the sign is subordinate to another sign, the station may request a certain size sign.

The text on information, welcome and orient, and concession area signs is called the message(s). Following are guidelines for developing sign messages:

- A single message should convey a single thought.
- Messages should:
 - Contain only essential information.
 - Be brief and simple.
 - Present the most important information first.
 - Identify station areas, offices, buildings, and features consistently (by the same name or title) throughout a field station.
- Generally, there should be no more than four messages on a sign.



Other options available on information signs include:

- Removable footboards for use where hours, fees, or regulations are subject to regular seasonal or periodic change.
- Distribution boxes for making brochures available. (Signs holding brochures should not be posted along a public road.)

Placement

Place information signs where they are needed and avoid overuse. Following are more guidelines:

- Do not place signs where they might create distractions, obstructions, or hazards.
- Place signs meant for pedestrian viewing at eye level (about 5' 5").
- You can place larger signs for viewing at greater distances proportionately higher.
- Signs posted along roads should generally be at least 12 feet from the edge of the traveled way.

You can mount most information signs on standard 4"×4" or 4"×6" CCA-treated wood posts. Greener alternatives to CCA posts may be available locally, such as alkaline copper quaternary (ACQ). Use of standard posts eliminates the need for breakaway design. Larger signs may need more than one post or larger diameter posts (6"×6", 8"×8",

10" × 10", etc.) to provide adequate support against wind loading. You can find more information on determining the number of posts needed for a sign on page 3-13.

Mount signs using a vandal-resistant hardware set with a 5/16" × 6" or 8" bolt for 4" × 4" and 4" × 6", respectively. If you want predrilled holes, specify this on the order form. Signs intended for viewing from a road should be posted with the lower edge of the sign at least 5 feet above the level of the roadway. You can find more detailed information on mounting signs in the Installation/ Mounting section, [pages 3-4 through 3-5](#) in this handbook.

In accordance with [Title 18, United States Code, Section 4124](#), you must order information signs from UNICOR or another approved sign vendor under [FAR Part 8.6](#). Use the Service Sign Order Form (FWS Form 3-2 040) to order information signs.

Maintenance

Clean and inspect information signs regularly. If a sign has been vandalized or otherwise damaged, the cost of repair in time and materials should be weighed against the cost of a replacement sign. Replace badly damaged signs. You can find more detailed information on the cleaning and repair of plywood-substrate signs in [Appendix 4](#) of this handbook.

General Information Signs

General information signs are made of HDO plywood or suitable substrate with white reflective lettering and borders on a brown reflective background. If applicable, the U.S. Fee Area symbol should appear on general information signs. When used, this symbol should be placed to the left of the text.

Use/Purpose

General information signs inform visitors of opportunities, services, activities, hours of operation, and regulations at a field station.

There are two categories found on “activities” signs – “Facilities and Activities” and “Prohibited Activities.” Neither side should contain more than six items. Using universal symbols, we first emphasize identifying the activities we offer. Facilities include visitor facilities, boat ramps, and interpretive trail or wildlife drives.

Secondly, we identify those activities that are general, but in some cases, may be unique. We consider listing such obvious activities as wildlife observation, environmental education, or nature study last, as well as hunting or other activities that require special permits or regulations and affect a small percentage of the public. Instead of using a sign, consider placing this type of information online and in brochures.

The “prohibited activities” side should include only the highest priority regulations. When posting this information, keep the number of items less than or equal to the number of items listed under available facilities and activities to avoid an overly negative impression. This category uses the same family of universal symbols as the available activities with red slashes through the symbol.



Concession Area Signs

Concession area signs identify a concession operation and provide information on rates or fees for commercial goods or services offered.

The standard substrate for concession area signs is 5/8" HDO plywood with white reflective text and borders on a brown reflective background.

The text on concession area signs, in addition to the general guidelines offered, should answer questions by providing all essential information on rates, fees, hours, restrictions, etc. If the information is too long or complicated for a sign, provide it in a brochure available at the sign or nearby.

Service Building Identification Signs

Building designation signs identify buildings by name (Visitor Center, Office, etc.). If appropriate, the hours of operation should be listed, either as a permanent part of the sign, if hours remain the same all year, or on removable panels, if hours change. Standard building designation signs use Helvetica bold lettering and both upper and lower-case letters. Removable panels should not affect sign design.

Building designation signs come in standard and non-standard varieties. Standard building designation signs are made of 5/8" HDO plywood or other approved substrate with white reflective lettering and borders on a brown reflective background.

Non-standard building designation signs are designed to be appropriate for the architectural style of the building and are made of the same or a complementary material. They may be designed and made by the builder at the time the building is constructed, or you can buy them from a commercial source. For advice regarding building designation signs, contact your Regional Sign Coordinator.

You may use the Service emblem on these signs. If you use the emblem, it should appear on the left side of the sign, with all text placed to the right, using a flush left margin.

Field stations may not make building designation signs. Order standard building designation signs using the Service Sign Order Form (FWS Form 3-2040) with a purchase order.

Order non-standard building designation signs through local or other appropriate sources. Information for ordering non-standard signs is available from the Regional Sign Coordinator.

Placement

Building designation signs should be placed at eye level (about 5' 5") on the front exterior wall of the building, near the main entrance. However, they may be placed along the building's approach road or walk at any suitable height. Signs placed along roads must meet the same standards of design, placement, and mounting as general information signs.

Mounting

When installing building designation signs on buildings, use rust-proof hardware suitable for the type of building material used. Others should be mounted on CCA-treated wood posts using vandal-resistant hardware. Greener alternatives to CCA posts may be available locally, such as alkaline copper quaternary (ACQ).

Ready Reference Guide to Guide Signs

	General Guide Signs	Advance Notice Signs
Use	Placed on Service lands to indicate: <ul style="list-style-type: none"> ■ Destination distance. ■ Direction. ■ Route of travel. 	Place off Service lands to direct visitors to destinations on Service lands.
Description	HDO plywood substrate, aluminum, or poly-metal covered with reflectorized vinyl sheeting. White reflective letters on brown reflective background.	Standards are usually determined by the agency with jurisdiction over the road.
Design Standards	Sign size and letter height are determined by speed of traffic and viewing distance. U.S. Fee Area symbol should be used, if applicable. Letter style is Helvetica bold. Messages always involve destination/direction information.	Messages always direct visitors to destinations on Service lands. Color and letter style are usually determined by the agency with jurisdiction over the road.
Placement	Signs should not be placed where they will create distractions, obstructions, or hazards. Place far enough ahead of turns for drivers to read and react safely. Signs posted along roads should be at least 12' from the edge of the traveled way. Follow <i>MUTCD</i> guidelines when posting these signs.	
Mounting and Installation	Bottom edges of signs should be mounted 5' above the level of the road. Most guide signs can be mounted on standard 4" × 4" or 4" × 6" posts. If you use posts that are larger than our standards for signs viewed by motorists, they must be of breakaway design unless the sign is protected by a guardrail or topographic change. Mount using vandal-resistant hardware.	
Ordering	Order from UNICOR or an approved sign vendor using Service Custom Order form (FWS Form 3-2040).	
Maintenance	Inspect and clean regularly. Wash with a mild, biodegradable detergent and water solution. If a sign is vandalized or otherwise damaged, weigh the cost of repair in time and materials against the cost of a replacement sign. Replace badly damaged signs.	

Guide Signs

These signs orient people to the location of our facilities and trails and establish regulations for the safety of our visitors and resources. General guide signs indicate destination direction, destination distance, or route of travel. There are two main kinds of general guide signs – those placed along roadways for motorists and those placed along foot, bicycle, horse, and canoe trails. Guide signs should be uniform and consistent with one another to make them more identifiable and visitor friendly. The sign should contain only essential information, brief and simple. This section is divided into two parts:

- Advance Notice signs
- General Guide signs

If you use a general guide sign to lead visitors to a fee area or pay booth, you should use the U.S. Fee Area symbol. You can find more information on using the U.S. Fee Area symbol on [page 5-28](#).

Description

General guide signs are made of 5/8" HDO plywood or other approved substrate with white reflective lettering and borders on a brown reflective background. Traffic volume over the course of 1 day (rather than road surface) determines what signs to use. To determine the type of roads, consult with your State department of transportation's engineering office. Many Service roads have daily volumes of fewer than 400 cars, which are low volume roads.

Field stations may not make general guide signs. In accordance with [Title 18, United States Code, Section 4124](#), you must order general guide signs from UNICOR or another approved sign vendor under [FAR Part 8.6](#). Use the Service Sign Order Form (FWS Form 3-2040) to order general guide signs.

Substrates:

- High Density Overlay 5/8" Plywood (HDO)
- Aluminum .080 gauge
- Poly-metal 6mm

Specific Vinyl Information:

EGP (Engineer Grade Prismatic)

- 3M series, 3430
- Type I, Reflective
- Off-road signage, parking lot, etc.

HIP (High Intensity Prismatic)

- 3M series, 3930
- Type IV, Reflective
- Roads, traffic control signs

Sign Faces:

- Sign faces have vinyl reflective 3M EGP 3400 series or 3M HIP 3900 series sheeting, recreation brown color PMS 469C.
- Signs have a 1/2" white reflective border out to the sign edge, and 2" radius corners in the white 3M 3290 reflective.

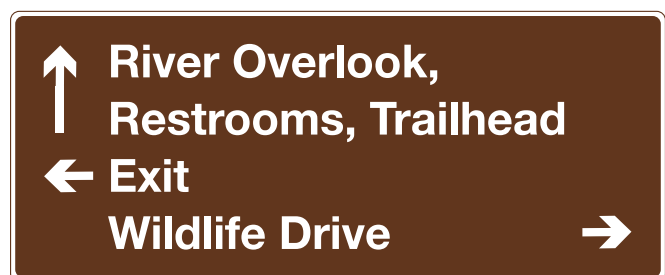



Text, Graphics:

- Text is white 3M EGP 3430 or 3M HIP 3930 reflective vinyl.
- Helvetica bold is the font for primary copy, using upper and lower-case letters.
- Helvetica medium is the font for secondary copy, using upper and lower-case letters.

Arrows cut to Service specs and are generally the same height as the capital letters. Arrows must be used on all U.S. Fish and Wildlife Service signs in the guide category when required to indicate direction. Arrows are available in sizes corresponding to letter height, but final decisions are left up to authorized fabricators for precise size of arrow on sign layout.

- Only use Federal recreation symbols.

Design Standards:

- *MUTCD* design requires that signs viewed from roads open to the public meet the following requirements:
 - Features such as size, contrast, colors, shape, composition, and reflectorization should work together to draw attention to the sign.
 - Shape, size, colors, and simplicity of message should work together to produce a clear meaning.
 - Legibility and size should work together with placement to permit adequate time for response.
 - Uniformity, size, legibility, and message should work together to command respect.
- The sign should contain only essential information, brief and simple.
- Sign size may be limited and stated for a specific size substrate (36" × 48") with letters to fit.
- Messages generally use flush left margins, but are centered when appropriate.
- No more than four messages per sign.
- Show destinations in the following sequence:
 - Straight-ahead arrows, lowest mileage first.
 - Left-turn arrows, lowest mileage, right-turn arrows, and lowest mileage first.
 - Place straight-ahead arrows and left-turn arrows in the left margin.
 - Place right-turn arrows in the right margin.
 - Indicate mileage with numbers only, express parts of miles as fractions, not decimals. Any distance less than ¼ mile expressed in feet.
- Text should include arrow and site name. Use mileage if necessary.

Advance Notice Signs

We place advance notice signs off Service lands to direct visitors to destinations on Service lands. Since advance notice signs are usually located on State, county, or local road rights-of-way, those agencies may define suitable sign substrates, colors, and letter styles based on their standards. Always work with your local department of transportation when planning for guide or advance notice signs.

Advance notice signs are most helpful to visitors when they include information about limitations on visiting hours or seasons and fees, if applicable. You may use Service emblems on these types of signs. See U.S. Fee Area symbol information on [page 5-28](#).

Using an advance notice sign may require the permission/cooperation of the State, county, or other agency having jurisdiction over the approach road or highway. We encourage project leaders to enter into Memorandums of Agreement with State or local highway agencies negotiating the terms of construction, installation, maintenance, and access for advance notice signs.

Field stations may not make advance notice signs. In accordance with [Title 18, United States Code, Section 4124](#), you must order general guide signs from UNICOR or another approved sign vendor under [FAR Part 8.6](#). Use the Service Sign Order Form (FWS Form 3-2040) to order general guide signs.

Guidance

The text on general guide signs and advance notice signs is arranged by message. These messages always involve identification/direction information. Use the following guidelines when developing them:

- Keep wording and messages to a minimum so it will be legible at a glance during the short time a driver can look away from the road.
- Show destinations in the following sequence:
 - Straight-ahead arrows, lowest mileage first.
 - Left-turn arrows, lowest mileage first.
 - Right-turn arrows, lowest mileage first.
 - Place straight-ahead arrows and left-turn arrows at the left margin.
 - Place right-turn arrows at the right margin.
 - Indicate mileage with numbers only.
 - Express parts of miles as fractions, not decimals, rounded to the nearest ¼ mile.
 - Use the abbreviation “ft” to indicate number of feet and “yds” to indicate number of yards.
 - Use no more than four principal messages per sign.

Only use Federal recreation symbols.



Crab Orchard National Wildlife Refuge

← Spillway Road Ponds

Crab Orchard Marina

Pavilion Use Rules

- Reservations required
- Open during daylight hours only
- Maximum occupancy is 50 people
- Cleaning deposit required

To reserve pavilion call the Visitor Center: (618) 998-5933

Devils Kitchen Lake

 North Public Boat Ramp →

 Picnic Area →

 Campground →

↑ Campground Registration

↑ Refuge Daily Passes

← Public Boat Ramp

← Group Picnic Area

Sign size varies according to the size of the letters and the amount of text. Signs intended for pedestrian viewing use smaller lettering and are generally smaller in overall size. If the sign will be read from moving vehicles, letter size is determined by traffic speed on the road where the sign is posted. Helvetica bold is the letter style, and both upper and lower-case letters are used.

Usually, the overall size of a sign is determined by the manufacturer unless there is a particular reason for the station to determine it. For instance, if there is minimal space for the sign or if the sign will be subordinate to another sign, the station may request a certain size sign. The table on [page 2-12](#) illustrates how to determine letter size. Once you know the letter size and amount of text, you can calculate the sign size using the chart in [Chapter 2 on page 2-12](#).

Placement

Only place general guide signs and advance notice signs where needed. Do not overuse. Further placement guidelines include:

- Do not place signs where they might create distractions, obstructions, or hazards.
- Place signs meant for pedestrian viewing at an appropriate level.
- You may place larger signs for viewing at greater distances proportionately higher.
- Signs posted along roads should be at least 12 feet from the edge of the traveled way.

Mount general guide signs on standard 4"×4" or 4"×6" CCA-treated wood posts. Use of standard posts eliminates the need for a breakaway design. Larger signs may need more than one post or they may need larger posts. You can find more information on determining the number of posts needed for a sign on [page 3-13](#).

Mount general guide signs using a vandal-resistant hardware set with a 5/16"×6" or 5/16"×8" bolt, depending on post size. If you want signs with predrilled holes, specify it on the order form. Post signs intended for viewing from a road with the lower edge of the sign 5 feet above the level of the roadway. You can find more detailed information on mounting signs in the installation and mounting section, [pages 3-4 through 3-5](#) in this handbook.

Maintenance

Clean and inspect general guide signs regularly. If a sign has been vandalized or otherwise damaged, the cost of repair in time and materials should be weighed against the cost of a replacement sign. Replace badly damaged signs. You can find more detailed information on the cleaning and repair of plywood-substrate signs in [Chapter 4](#) of this handbook.

Interpretive Signs

Interpretive signs are not a component of this handbook. For general information and guidance on interpretive panels, see [Appendix 10](#) and contact your Regional visitor services staff for information and Regional guidance.

Emblems and Decals

Emblems and decals identify specific managing agencies, ownership, or policies. We divided this part of the handbook into a section on the Service Emblem and the other emblems or identifiers.

The Service Emblem

The Service emblem is the identifying symbol of the U.S. Fish and Wildlife Service.

The Service emblem is available in the following sizes, which are designated for specific uses as shown:

- 24", 20", 16", and 12" – Standard entrance signs, aircraft, boats, and large displays
- 8" – Station headquarters and sub-headquarters, passenger vehicles, trucks, visitor centers, off-road vehicles, vehicle trailers, etc.
- 4" – Building entrances, small off-road vehicles such as snowmobiles and all-terrain vehicles, small boats, etc.
- 2" – Hardhats, notebooks, etc.



Description

The Service emblem must appear on entrance signs and all Service vehicles, except some law enforcement vehicles. It is used as a graphic on many area management signs.

In addition, the Service emblem should be displayed at carefully selected areas within the station, such as station headquarters, visitor centers, and contact stations.

Do not use the emblem indiscriminately. Overuse is as bad as under use. Do not display the emblem for personal use or on privately owned vehicles or articles. The Service Director is the only person who may approve use of the emblem on items other than those specified above. Use of the Service emblem is described in [041 FW 2](#), Emblems, in the Service Manual. When using the Service emblem with the Department's emblem, the Service emblem is always to the right.

The Service emblem is produced in different forms for specific uses:

- Reflective sheeting decals – for use on passenger vehicles, aircraft, trucks, trailers, boats/floating equipment, and off-road vehicles.
- Vinyl decals used on standard entrance signs: 4" (2'×4'), 8" (4'×8') and 12" (5'×10').
- Magnetic backing – for use on law enforcement vehicles.
- 16" molded plastic – for office display or other interior display.
- Screen print or digital print – for graphics uses such as banners or interpretive signs.
- Silk screened – for graphics uses such as on interpretive signs.
- Routed/sandblasted substrates – for office display or other interior display and in appropriate outside locations. (Presently available only from commercial contractors.)
- Other more permanent materials, such as porcelain on enameled steel on entrance signs, high-pressure phenolic resin, etched metal, laminated Lexan, and other new products. Many of these products have long-term warranties of 10 years or more. Contact your Regional Sign Coordinator for more current information.

Vehicle Mounting

The 8" Service emblem should be placed 2 inches below the "For Official Use Only – U.S. Government" decal. The bottom edge of the latter should be 4 inches below the vehicle window.

If the vehicle door design does not permit application in this format, center the emblem on the door with the legend centered 2 inches above it.

Mounting Reflective Decals

Before new decals can be applied, you must completely remove old decals and clean the surface. There are several ways to remove old decals:

Methods for Removing Vehicle Decals

Method #1 – Hair Dryer Method

Items Needed:

- Hair dryer
- Plastic scraper
- Extension cord
- Odorless mineral spirits
- Clean rags

Step 1: If possible, move the vehicle into a heated garage.

Step 2: Use hair dryer to heat the decal, starting with a corner.

Step 3: Take the plastic scraper and carefully work up a corner of the decal while using the dryer.

Step 4: Once you have a corner started, carefully and slowly pull the decal at a sharp angle with one hand while keeping the hair dryer going with the other. *Do not pull decal straight out from surface of vehicle.*

Step 5: Keep repeating Steps 2–4 until you have the entire decal removed.

Step 6: If any adhesive residue remains, use mineral spirits to clean it. Be sure to thoroughly wipe the vehicle surface clean after using mineral spirits. Mineral spirits can leave behind an oily residue that could destroy the paint finish and your new decal will not stick.

Method #2 – Mineral Spirits Method

Items Needed:

- Plastic scraper
- Odorless mineral spirits
- Clean rags

Step 1: If possible, move the vehicle into a heated garage.

Step 2: Take a clean rag and saturate it with the mineral spirits.

Step 3: Apply the rag to the surface of the decal, paying special attention to the edges and allowing the mineral spirits to soak the decal.

Step 4: Using the plastic scraper, start carefully working a corner of the decal up.

Step 5: As you expose the back side of the decal, re-saturate your rag with mineral spirits and apply it to the back of the decal, letting the spirits run down behind the decal.

Step 6: Keep repeating Steps 3–5 until you have the entire decal removed.

Step 7: If any adhesive residue remains, use the mineral spirits to clean it. Be sure to thoroughly wipe the vehicle surface clean after using mineral spirits. Mineral spirits can leave behind an oily residue that could destroy the paint finish and your new decal will not stick.

Be extremely careful when using all of these agents since they can cause paint damage, are highly flammable, and can be harmful if they come into contact with skin or eyes.

Preparing the Surface – The surface to which you will apply the decal must be clean. Remove oil, grease, and dirt using isopropyl alcohol, and then wipe the surface dry with a clean cloth.

Applying the Decal – The reflective sheeting is designed for application at temperatures between 50 and 90 degrees Fahrenheit. The adhesive will not adhere well to a colder or hotter surface.

When the application surface has been cleaned, align the decal, remove the backing sheet, and gently position the decal on the surface. Tack the decal in place with finger pressure at two points on the upper edge.

Peel and crease the backer sheet slightly (1/4" – 1/2"). Position the decal properly and rub down the exposed adhesive area of the 1/4" – 1/2", then take the slight backer flap and peel a bit more while rubbing down the decal and continue until the whole decal is rubbed down and in place.

To protect the surface of the decal, use the just removed backer sheet on top of the decal and rub with a decal applicator squeegee on this backer sheet with overlapping strokes from the center out to the edge. This helps force air under the decal out to the edges to escape. If there is a small air bubble in the decal, you can prick it with a pin and rub it down.

Re-squeegee the edges using firm pressure. Finally, wipe the face of the decal with a soft cloth to remove any surface dust.

Decal Storage – Store decals flat in a cool, dry place with slip sheets between them so they will not stick together under stack pressure. The normal shelf life for emblems, vehicle door legends, and other decals is about 1 year. After that time the protective backing begins to pull away from the edges of the decal, exposing the adhesive to air. This causes the adhesive to dry out and lessens its holding power.

Ordering

Order decals from an approved vendor on the Service Sign Order Form (FWS Form 3-2040)

Order emblems and decals by code number. Order codes for the various decal sizes and substrates are in the table below. The order code incorporates the following information:

- FWS = Service identity
- I = Information
- D = Decal
- R = Reflectorized
- AM = substrate (aluminum or magnetic)
- numbers = size

Maintenance

To clean routed emblems or mounted decals, dust the surface and wash with a damp sponge or mild soap and water solution. When cleaning decals, be careful not to loosen the edges. Replace cracked or damaged decals.

Other Emblems

We sometimes place other emblems with the Service emblem to identify the Service or Service objectives on official vehicles such as boats, cars, and equipment operating at field stations or on articles such as notebooks, hardhats, or large exhibits. Do not use other emblems alone; they must be used with the Service emblem or corresponding text. When using the Service emblem with other identifiers, always put the Service emblem to the left. The only exception is when you use the Department's emblem with the Service emblem, the Service emblem goes to the right. Contact your Regional Sign Coordinator for specific information on proper placement of the Service emblem with other emblems.

Description

The Service currently uses the following decals in addition to the Service emblem:

- *For Official Use Only U.S. Government vehicle door legend* – Available with brown (for use on light-colored vehicles) or white (for use on dark-colored vehicles) letters on transparent background. (2”H×10”W). These must appear on all Service vehicles except some law enforcement vehicles.
- *Youth Conservation Corps decal* – Blue and green on white. The Youth Conservation Corps decal may be placed on notebooks and hardhats only.
- *U.S. Fee Area symbol* – PMS 871 gold and black outline and text. Post the U.S. Fee Area symbol at all public access points to entrance and user fee sites. It is available in three sizes:
 - The 4” decal is for close-up viewing.
 - The 9” decal is for areas accessible by foot.
 - The 18” decal is for use at the entrances of all fee areas and other appropriate sites viewed from a vehicle.

When you use the U.S. Fee Area symbol on advance notice, information, or guide signs, place the symbol vertically centered, to the left of the text.



Federal Recreation Symbols

Federal recreation symbols graphically inform visitors of available services and of permitted and prohibited activities on Service lands. They may be used alone, on guide signs, and on information signs. These symbols should, whenever possible, match the Federal recreation symbols developed by SEG D for the U.S. Fish and Wildlife Service Design Standards. See [Appendix 6](#).

Field stations may not make Federal recreation symbol signs.

In accordance with [Title 18, United States Code, Section 4124](#), order Federal recreation symbol signs must from UNICOR or another approved sign vendor under [FAR Part 8.6](#). Use the Service Sign Order Form (FWS Form 3-2040) to order Federal recreation symbol signs.

Description

- *Color* – The symbols are reflective white on a brown reflective background, except for the (international symbol of access wheelchair symbol), which is white on blue. The slash used to denote a prohibited activity is red reflective. The direction of the slashes is always from left to right. Secondary legends are of appropriate color.
- *Substrate* – HDO 5/8” plywood covered or aluminum covered with reflective sheeting
- *Message* – Because of widespread public recognition and acceptance of Federal recreation symbols, we do not accompany the symbols with a message, except for in the following two circumstances:
 - If a symbol is new, or its use in a particular area is new, it may be accompanied by a message to help ensure understanding and compliance.

- Prohibitions will always be accompanied by an explanatory message to reinforce the impact of the sign and clarify its meaning for enforcement purposes. When an accompanying message is used, the message is put on one, two, or three lines.
- *Layout* – Try to keep a positive approach to signage, having as many permitted recreation symbols as prohibited recreation symbols. List the most important symbols first and do not exceed six permitted and six prohibited recreation symbols per sign. Don't list obvious activities, e.g., wildlife observation.

Placement

You may place Federal recreation symbol signs where necessary to inform visitors of available services and permitted/prohibited recreational activities. Be careful to avoid using these everywhere. They can become a visual blight and ruin the nature of the outdoor experience.

Mount Federal recreation symbol signs on 4" × 4" CCA-treated wood posts, galvanized metal posts, or Carsonite posts. Greener alternatives to CCA posts may be available locally, such as alkaline copper quaternary (ACQ). Use of standard posts eliminates the need for a breakaway design. You may mount replacement signs on existing metal posts when the posts are in good condition. Use vandal-resistant hardware to install the signs.

When you post a Federal recreation symbol sign along a road with a speed limit of 30 mph or more, they should be:

- Posted at least 12 feet from the edge of the traveled way, and
- Mounted on the post so the lower edge of the sign is 5 feet from the level of the road.

Maintenance

Clean and inspect Federal recreation symbol signs regularly to ensure proper maintenance. Information on the inspection and maintenance of signs is found in [Chapter 4](#) of this handbook.

Ordering

Order standard Federal recreation symbol signs Sign Order Form (FWS 3-2040), showing an illustration or a sketch. If a non-standard recreation symbol logo is necessary, consult your Regional Sign Coordinator. Regional Sign Coordinators may, at their discretion, waive the requirement for Regional approval and authorize field station managers to submit purchase orders for Federal recreation symbol signs directly to UNICOR or an approved vendor.

If you are requesting secondary custom legends that require incorporation of arrows, mileage information, etc., order the sign by submitting the Service Custom Sign Order (FWS Form 3-2040) with an acquisition request and include an illustration/ sketch of the sign needed. See U.S. Fish and Wildlife Service Recreational Symbols in [Appendix 6](#).



Traffic Control Devices

Traffic control devices are all signs, signals, markings, and devices placed on, over, or adjacent to a road to regulate, warn, or guide traffic. This means that, in addition to the standard traffic signs, any sign we post for someone to read from a public road is a traffic control sign. The Service signs that are most often placed along roads are entrance, information, and guide signs. Recreation symbols typically appear on information signs and singly on tour routes, and trails. These signs are reflective and conform to Federal laws regulating the design of traffic control signs.

Area management, safety, and interpretive signs are not intended for reading from a moving vehicle and do not have to meet Federal standards for traffic control signs.

This section clarifies the use of traffic control signs and devices on Service facilities and should help managers apply traffic control techniques to ensure safe, efficient travel on Service roads.

The [*Manual on Uniform Traffic Control Devices* \(MUTCD\)](#) is the official standard for use on all roads open to public travel. This means that the *MUTCD* guidelines govern the selection, design, and placement of all traffic control devices and signs we post for viewing from Service roads that are open to public travel, even if they are seasonal or intermittent.

To be effective, a sign must:

- Be necessary.
- Command attention and respect.
- Convey a clear message.
- Give adequate time for proper response.

We should use signs only where warranted. Overuse is as bad as under use or misuse. Signs are essential where special regulations apply at specific places or at specific times, and where hazards are not obvious. The standards and provisions here do not substitute for engineering judgment when selecting traffic control devices. Consult State or local highway departments for assistance if needed.

Description

The Service sign program most often uses the following types of standard traffic control signs:

- *Regulatory signs* – Regulatory signs give notice of traffic laws or regulations and include the following types of signs: stop, yield, speed, movement, turning, alignment, exclusion, one-way, parking, and pedestrian. Details on regulatory signs are found in [Part 2B](#) of the *MUTCD*.
- *Warning signs* – Warning signs call attention to conditions that are potentially hazardous on or near the road. Typical hazards warranting the use of warning signs include:
 - Changes in the horizontal alignment of the road
 - Intersections
 - Advance warning of control devices
 - Converging traffic lanes
 - Narrow roads
 - Changes in highway design
 - Grades
 - Road surface
 - Railroad or other crossings

Details on warning signs can be found in [Part 2C](#) of the *MUTCD*.

As mentioned above, entrance, information, guide, and Federal recreation symbol signs posted for viewing from vehicles are also considered traffic control signs for the purpose of this section of the handbook.

Other Traffic Control Devices

The *MUTCD* guidelines for the traffic control devices listed below also apply on Service lands. For more detailed information, consult [Section III](#) of the *MUTCD*.

Field stations may not make traffic control signs.

- Road markings
- Road delineators
- Object markers
- Barricades
- Road closures
- Miscellaneous
 - Civil defense signs
 - Traffic control for road construction and maintenance
 - Traffic control for railroad crossings
 - Traffic control for bicycle facilities

Ordering

Order traffic control signs and devices using a Sign Order Form (FWS Form 3-2040), and include an illustration or a sketch. Check the *Manual Uniform Traffic Control Devices* Web site for the latest updates: <http://mutcd.fhwa.dot.gov/>

In accordance with [Title 18, United States Code, Section 4124](#), you must order traffic control signs/devices from UNICOR or another approved sign vendor. Use the Service Sign Order Form (FWS Form 3-2040) to order traffic control signs and devices. Regional Sign Coordinators may, at their discretion, waive the requirement for Regional approval of FWS Form 3-2040.

Traffic control signs can be found in the [Standard Highway Handbook](#), dated 2004, or the [MUTCD](#).

The *MUTCD* sign catalog is periodically revised by the Federal Highway Administration. We will post revisions on the Service Web site.

Safety Signs

Safety signs provide visitors and Service employees with information or rules relating to health and safety. The safety sign system was developed in compliance with standards set by the American National Standards Institute and the Occupational Health and Safety Administration. The system is intended for use in both public and restricted areas of Service facilities. Proper warning and use of safety signs reduce any potential negligence on the part of staff, the field station, and the Service. Guidelines on safety signs may be found at [OSHA 29](#), CFR 1910, and [Synthesis of Non-MUTCD Traffic Signing](#). Following are basic types of safety signs:

- Safety instruction signs
- Caution signs
- Danger signs
- Warning signs
- Hazard signs
- Notice signs
- Safety equipment/directions signs

The following guidance applies to all safety signs:

Do not post signs for open and obvious hazards, e.g., uneven walking surfaces, etc. Signs such as this lessen the impact of the important safety signs.

Post signs for hidden hazards, i.e., sudden dangerous condition changes, etc. Think of a hidden hazard as one a prudent person would not expect to encounter when engaged in a routine activity.

Failure to post and maintain warning signs may be grounds for a finding of willful and malicious negligence if there is an accident.

Posting and maintaining quality warning signs provide a basis for contributory negligence defense. Such signs allow us to show that we warned the prudent person adequately of the hazard, and any injuries are the result of a conscious decision to ignore the warning sign.

- Be direct (state the hazard, don't be ineffectual).
- Be brief (state the hazard in as few words as possible).
- Be accurate (don't overstate or understate the potential hazard or its effects).
- Be positive (people are less apt to heed signs that begin with "Don't").
- Be seen (put the sign where it is obvious and keep the foliage cleared away).
- Be attractive (be as professional as possible).
- Be legible (if time does not permit a manufactured sign, use your best penmanship).
- Be proportionate (make the important words big and the modifiers small).
- Be obvious – let visitors understand this is serious.
- Maintain warning signs to continue their credibility and effectiveness.
- Rather than tell the visitor what not to do, good warning signs describe safe behavior.
- SAFETY RED means Danger and Stop.
- SAFETY ORANGE: Dangerous parts of machines or energized equipment.
- SAFETY YELLOW designates caution or physical hazards. Use solid yellow, yellow and black stripes, or yellow and black checkers for maximum contrast with the particular background.

Description

Safety signs can be made of aluminum, wood, fiberglass, plastic, or other suitable substrate. They also are available as self-adhesive decals. Most safety graphics, symbols, colors, and headings are standard and there are no available options. You should only use other messages when absolutely necessary. The messages are simple and direct with a positive tone. They are available in several sizes.

Placement

Safety signs are meant to be read by pedestrians. They are not road signs. Place them conspicuously in the area where they are needed without creating a distraction or a hazard.

Place small signs intended for close viewing at eye level – about 5' 5". Larger signs may be posted proportionately higher. Avoid placing too many signs in one location because it creates confusion and reduces the signs' effectiveness. Except when absolutely necessary to fulfill their purpose, do not place safety signs on or next to moveable objects (such as doors, racks, and windows) that when moved could hide the sign.

Mounting

You may mount safety signs on walls, fences, posts, or where necessary for maximum visibility. Fiberglass, plastic, aluminum, and poster signs can be mounted with small screws or with double-sided foam tape. You may order the signs with predrilled holes for mounting. Predrilled holes are 1/8" in diameter, one in each of the four corners.

Ordering

Field stations may not make safety signs. In accordance with [Title 18, United States Code, Section 4124](#), order safety signs from UNICOR or another approved sign vendor. Use the Service Sign Order Form (FWS Form 3-2040) to order safety signs.

Submit all orders to the Regional Sign Coordinator for approval. Regional Sign Coordinators may, at their discretion, waive the requirement for Regional approval and authorize field station managers to submit orders for safety signs directly. Under emergency circumstances, you may buy safety signs by the most expedient method. Consult the [OSHA Web site](#) for signs and vendors.

Maintenance

Safety signs are subject to Service standards of inspection and maintenance. These standards require regular inspection to ensure that the signs remain appropriate, clean, and in good condition. You can clean most safety signs with a mild soap and water solution. The maintenance section of this handbook includes instructions for repairing damaged or vandalized wood and aluminum signs, although you should only do this if you determine that repair is more cost-effective than replacing the sign. Replace fiberglass and plastic signs and decals when cracked, broken, or damaged.

Appendix 1

References

U.S. Fish and Wildlife Service Manual, Symbols (Part 041): [041 FW 3](#)

Legal Authorities for Sign Program

- A. [Title 23, U.S. Code, Sections 109\(b\), 109\(d\), and 402\(a\)](#).
- B. [23 CFR 1204.4 and 1230.4](#), and [43 CFR 8000](#) in its entirety.
- C. [National Trails Systems Act, PL 90-543](#), as amended through 2010.
- D. [Manual on Uniform Traffic Control Devices \(MUTCD\)](#), Department of Transportation, Federal Highway Administration, 1978 Edition, and all subsequent revisions through 2017.
- E. [Traffic Control Devices Handbook](#), Department of Transportation, Federal Highway Administration, 1983, Update 2005.
- F. [Standard Highway Signs](#), Department of Transportation, Federal Highway Administration, 1979, Update 2004.
- G. Highway Safety Act, [PL 89-564](#), 1966, as amended through 2010.
- H. Uniform State Waterway Marking System (USWMS). [Titles 33 and 46](#), Code of Federal Regulations.
- I. [Title 18, United States Code, Section 4124](#).

Note: [FAR Part 8.6](#) now states:

- (1) Before purchasing an item of supply listed in the Federal Prison Industries (FPI) Schedule, conduct market research to determine whether the FPI item is comparable to supplies available from the commercial sector, and that they best meet the Government's needs in terms of price, quality, and time of delivery. This is a unilateral determination that the Contracting Officer makes. The arbitration provisions of [18 U.S.C. 4124\(b\)](#) do not apply.
- (2) Prepare a written determination that includes supporting rationale explaining the assessment of price, quality, and time of delivery, based on the results of market research comparing the FPI item to supplies available from the commercial sector.
- (3) If the FPI item is comparable, purchase the item from FPI following the ordering procedures at www.unicor.gov, unless you obtain a waiver in accordance with [8.604](#).
- (4) If the FPI item is not comparable in one or more of the areas of price, quality, and time of delivery –
 - (i) Acquire the item using –
 - (A) Competitive procedures (*e.g.*, the procedures in [6.102](#), the set-aside procedures in [Subpart 19.5](#), or competition conducted in accordance with [Part 13](#)); or if the item is not available through FedBizOpps, provide a copy of the solicitation to FPI. Documentation to the procurement file is vital.

Additional References

The following are additional references. Use the most recent edition of each of these references.

- [Traffic Control Devices Handbook](#), 2001 edition, Institute of Traffic Engineers, (purchase only, not available to view online)
- [Roadside Design Guide](#), third edition, 2002, American Association of State Highway and Transportation Engineers, (purchase only)
- [Guidelines for Geometric Design of Very Low Volume Roads](#), 2001 edition, American Association of State Highway and Transportation Officials, (purchase only)
- [Sign Installation Guide](#), (1/2-page sized booklet) July 2003 USDA, Forest Service
- [A Guide to Small Sign Support Hardware](#), American Association of State Highway and Transportation Officials, 1998, GSSH-1 (purchase only)
- [U.S. Coast Guard \(USCG\) Aids to Navigation \(ATON\) System](#)
- [Standard Highway Signs and Markings \(SHSM\) Book](#)
- [Manual and Guides for Trail Design, Construction, Maintenance, and Operation, and for Signs](#)

The following documents are available from the United States Access Board.

- [Architectural Barriers Act Standards](#)
- [Outdoor Recreation Guidelines](#)
- [Outdoor Developed Areas](#)

The “NPS Traffic Control Sign System Guideline (NPS-52)” is available from the National Park Service; Engineering and Safety Services Division; Washington, D.C. 20013-7127.

The following documents are available from the U.S. Department of Transportation; Federal Highway Administration, (HTO-21); Washington, D.C. 20590.

- [Standard Alphabets for Highway Signs](#) (FHWA)
- [Specifications for Standard Highway Sign Colors](#) (FHWA)

The “Transportation and Traffic Engineering Handbook” is available from the Institute of Transportation Engineers; 525 School Street, S.W.; Washington, D.C. 20024.

The “Traffic Engineering for Better Signs and Markings” is available from the Military Traffic Management Command; Transportation Engineering Agency; ATTN: MTT-TE; P.O. Box 6276; Newport News, Virginia 23608.

The following documents are available from U.S. Department of Agriculture; Forest Service; Equipment Development Center; Missoula, Montana 59801.

- Anti Sign Theft and Vandalism Guide (USFS)
- Signs Maintenance Guide (USFS)
- Placement Guide for Traffic Control Devices (USFS)

The United States Sign Council offers the following publications on sign letter size, viewing distance, and travel speed.

- [Computation Equations](#), 2007
- [Sign Legibility Rules of Thumb](#), 2006
- [On-Premise Signs Guideline Standards](#), 2003
- [Model On-Premise Sign Code](#), 2011

Information on sign retroreflectivity:

- http://safety.fhwa.dot.gov/roadway_dept/night_visib/

Appendix 2

Color Specifications

U.S. Fish and Wildlife Service Emblem Color Specifications

Die-cut shield shape emblem fabricated from 3M Scotchlite Reflective Sheeting #680-10 or other material of equal or greater value. All inks except that used for text and border *must* be translucent. All inks used *must* be compatible with the reflective sheeting being used and there should be no more than 1/32" overlap between colors.

Pantone color specifications are as follows:

- Background – Pantone 467 (Light Brown)
- Text and Borders – Pantone 476 (Dark Brown)
- Sun – Pantone Process Yellow
- Sky – Pantone 129 (Light Yellow)
- Mountains – Pantone 138 (Brown/Orange)
- Bird, Lake, and Fish – Pantone 300 (Blue)



U.S. Department of the Interior Seal Color Specifications

Seal Element	Color	Cloth	Federal Standard	Pantone	CMYK
Destination Band	White	67101	27886	White	0, 0, 0, 0
Inner/Outer Borders	Golden Yellow	67104	13655	116	0, 15, 94, 0
Letters, Numbers and Bullets	Gold Brown	67194	10115	471	0, 56, 100, 18
Sky	Forget-me-not Blue	67168	25526	304	30, 0, 6, 0
Sun	Golden Yellow	67104	13655	116	0, 15, 94, 0
Sun Rays Inner	Scarlet	67111	11105	200	0, 100, 65, 15
Sun Rays Middle	Golden Orange	67100	mix to match	137	0, 34, 91, 0
Sun Rays Outer	Golden Yellow	67104	13655	116	0, 15, 94, 0
Mountains	Old China Blue	67169	25177	345	56, 15, 0, 6
Snow caps	White	67101	27886	White	0, 0, 0, 0
Grass Dark	Green	67129	14110	364	72, 0, 100, 43
Grass Light	Emerald Green	67128	14187	368	69, 5, 96, 0
Dirt	Gold Brown	67194	10115	471	0, 56, 100, 18
Bison	Brown	67136	10091	181	0, 72, 79, 47
Details	Black	67158	17038	Black	0, 0, 0, 100
Horns	White	67101	27886	White	0, 0, 0, 0



Common Uses of Sign Colors

Type of Sign	Legend								Background										
	Black	Green	Red	White	Yellow	Orange	Fluorescent Yellow-Green	Fluorescent Pink	Black	Blue	Brown	Green	Orange*	Red*	White	Yellow*	Purple	Fluorescent Yellow-Green	Fluorescent Pink
Regulatory	X		X	X					X					X	X				
Prohibitive			X	X										X	X				
Permissive		X													X				
Warning	X															X			
Pedestrian	X															X		X	
Bicycle	X															X		X	
Guide				X							X								
Interstate Route				X						X				X					
State Route	X														X				
U.S. Route	X														X				
County Route					X					X									
Forest Route				X							X								
Street Name				X								X							
Destination				X								X							
Reference Location				X								X							
Information				X						X		X							
Evacuation Route				X						X									
Road User Service				X						X									
Recreational				X							X	X							
Temporary Traffic Control	X												X						
Incident Management	X												X						X
School	X																		X
ETC-Account Only	X																X****		
Changeable Message Signs																			
Regulatory			X***	X						X									
Warning					X					X									
Temporary Traffic Control					X	X				X									
Guide				X						X			X**						
Motorist Services				X						X	X**								
Incident Management					X			X		X									
School, Pedestrian, Bicycle					X		X			X									

* Fluorescent versions of these background colors may also be used.

** These alternative background colors would be provided by blue or green lighted pixels such that the entire CMS would be lighted, not just the legend.

*** Red is used only for the circle and slash or other red elements of a similar static regulatory sign.

**** The use of the color purple on signs is restricted per the provisions of Paragraph 1 of Section 2F.03.

Pantone Matching Colors for *MUTCD*

The following are [Pantone specifications](#) for printing purposes only. They provide a guide for selecting appropriate ink colors to closely match the standard colors of traffic control signs. **The Pantone specifications are not for use in sign fabrication.** *Note:* There are no Pantone specifications available for fluorescent alternatives of standard colors.

Brown	469
Yellow	116
Green	342
Orange	152
Yellow-Green	382
Red	187
Purple	259
Blue	294
Pink	298

Appendix 3

Design Standards for Service Signs

Overview

Identity manifests itself in many ways. A primary way the Service establishes its identity is sign and symbols. Identity is more than the Service emblem; it is the reflection of overall management and continuity of the sign program. All staff play an integral role in identity planning. A uniform system of attractive, well-maintained signs enhances the Service's identity and promotes public recognition of Service goals and objectives. In addition, it provides a finished look to Service field stations and guides visitors to approved visitor facilities and use areas.

This section describes the principles of sign design. It includes information on message preparation and legend content as well as panel design. Since national sign and brand uniformity is a goal of the Service sign program, there is limited opportunity for design variations in signs or symbols. An understanding of design principles is helpful in making decisions about the selection and use of signs as well as in facilitating overall management of a station sign program.

Signs should:

- a. Fulfill a need.
- b. Command attention.
- c. Convey a clear, positive, and simple message.
- d. Identify Service lands.
- e. Meet accessibility requirements where appropriate.

Specific elements of sign design are in the sections that follow. The first section discusses sign messages. It includes information on message and legend content. The second section discusses panel design. It includes information on typography, color, layout, and size.

Manual for Uniform Traffic Control Devices Design Requirements

The [*Manual on Uniform Traffic Control Devices*](#) (*MUTCD*) is the national standard for signs, markings, pavement markings, and other devices used to control traffic (traffic control devices) on all roads open to public travel. Traffic control devices must be constructed, located, installed, and maintained according to the standards contained in the *MUTCD*. Refer to it for guidance and specific information for all standard signs and devices.

Some devices in the *MUTCD* have been changed, deleted, and/or added. Refer to the current edition of the *MUTCD* for specific guidance and target dates for compliance for these devices.

MUTCD standards use the following basic considerations:

- Features such as size, contrast, colors, shape, composition, and [reflectorization](#) should work together to draw attention to the sign.
- Shape, size, colors, and simplicity of message should work together to produce a clear meaning.
- Legibility and size should work together with placement to permit adequate time for response.
- Uniformity, size, legibility, and message should work together to command respect.

Individual States may have their own supplements to the *MUTCD*. Check with your local transportation department.

Message

A sign is designed for the first-time viewer. It is important that sign messages be brief and easy to understand. Word legends should clearly convey the intended message. We encourage the use of symbols on signs, provided they clearly convey the intended message. Under normal driving conditions, there is little time between being close enough to read the sign and passing the sign. Consequently, messages should cover the essentials (for example, destination or direction). These guidelines apply to sign messages:

When composing a message, consider the following guidelines:

- a. Messages should contain only essential information.
- b. Signs should express a single thought in a single message. Some guide signs and some information signs may need to convey more than one message, but a single sign should not have more than four messages.
- c. Sign language should be simple and consistent.
- d. Sign messages should present information in a logical order. The most important information should appear on the first line.
- e. Word the message in a *positive* manner unless it reduces the clarity of the idea. As a rule-of-thumb, *ninety percent* of a station's signs should have a positive tone.
- f. Use no more than four words per message, except where the proper name of a destination is more than four words long.
- g. Use a minimum number of word lines.
- h. Use no more than three lines per message, except where a proper name of a certain size requires more than three lines.
- i. Signs should use both upper and lowercase letters. Capitalize the first letter of all proper nouns unless Federal guidelines require all uppercase letters.
- j. Keep message short by using commonly recognized abbreviations in the table on the next page. Do not use periods after the abbreviations in this table.

You may only use Federal recreation symbols in sign messages. For safety signs, you must use OSHA standard symbols. You may use Federal recreation symbols on all other signs, including the International Symbol for Accessibility.

Pedestrians and those on bicycles and horseback have time to pause and leisurely read sign messages. The rules above, therefore, do not apply to trail signs. However, the wording of trail signs should be concise. Descriptive text should be relevant and contain only information of general interest. The accessibility guidelines for outdoor developed areas address access to trails, picnic and camping areas, viewing areas, beach access routes and other components of outdoor developed areas on federal sites when newly built or altered. They also provide exceptions for situations where terrain and other factors make compliance impracticable. The requirements are located in sections F201.4, F216.3, F244 to F248, and 1011 to 1019 of the ABA Standards.

Acceptable Abbreviations(See *MUTCD, Part 1 – General, Tables 1A-1 and 1A-2*)

Full Word	Abbreviation	Full Word	Abbreviation
Afternoon/Evening	PM	Miles Per Hour	MPH
Alternate	ALT	Minimum	MIN
AM Radio	AM	Monday	MON
Avenue	AVE, AV	Mount	MT
Bicycle	BIKE	Mountain	MTN
Boulevard	BLVD	National	NATL
Bridge	BR	North	N
Center (part of a place name)	CTR	Parkway	PKWY
Circle	CIR	Pedestrian	PED
Court	CT	Place	PL*
Crossing	X-ING	Road	RD
Drive	DR*	Saint	ST
East	E	Saturday	SAT
Expressway	EXPWY	South	S
Feet	FT	Street	ST
Freeway	FRWY/ FWY	Sunday	SUN
Friday	FRI	Telephone	PHONE
Hazardous Material	HAZMAT	Temporary	Temp
High Occupancy Vehicle	HOV	Terrace	TER
Highway	HWY*	Thursday	Thursday
Hospital	HOSP	Thruway	THWY
Hour(s)	HR, HRS	Trail	TR
Information	INFO	Tuesday	Tuesday
International	INTL	Turnpike	TPK
Interstate	I-(#)	2-way intersection	2-WAY
Junctions/ Intersection	JCT	U.S. numbered route	US
Lane	LN	Wednesday	WED
Maximum	MAX	West	W
Mile(s)	MI		

Unacceptable Abbreviations

(See *MUTCD, Part 1 – General, Table 1A-3*)

Do not use these abbreviations because they can be misinterpreted.

Abbreviation	Intended Word	Common Misinterpretation
ACC	Accident	Access (Road)
CLRS	Clears	Colors
DLY	Delay	Daily
FDR	Feeder	Federal
L	Left	Lane (Merge)
LT	Light (Traffic)	Left
PARK	Parking	Park
POLL	Pollution (Index)	Poll
RED	Reduce	Red
STAD	Stadium	Standard
WRNG	Warning	Wrong

Typography

Use Helvetica font on all Service signs, except you must use Swiss 721 BT Bold Condensed and American Typewriter TC BT Medium on all Service entrance and blue goose welcome signs. Alternate fonts are not acceptable. For specific font requirements, see sign specifications for each type of sign in [Chapter 5](#).

Case

For optimum readability, all text is in upper and lowercase letters with initial capital letters. Acronyms are all uppercase. Studies have shown that lower case text is easier and faster to read than all uppercase text.

Letter Size

Select letter size so the sign will be readable from the desired viewing distance. Signs viewed from a distance and from moving vehicles require more space between letters than those viewed by pedestrians. The sign manufacturer determines the letter size on information and guide signs according to the viewing distance and/or vehicle speed specified on the Service Sign Order Form (FWS Form 3-2040). Few other instances require letter-size information from Service staff.

Larger letter sizes may require larger signs. Manufacturers make signs either according to specified dimensions or according to the requested layout. Consult your Regional Sign Coordinator for any questions or further information.

Line Length

The number of words and length of each line affects the appearance of a sign. Sign layout elements include visual balance, legibility, and message impact. A single message on a sign may use two or more lines to maintain proportionality. A two-line message is visually stronger if the first line is slightly longer than the second line. A three-line message generally has greater visual balance if the middle line is slightly longer than the other two. You can reduce line length by using commonly recognized abbreviations, such as those in the table on the previous page.

Linespace

The space between multiple-line sign legends is linespace. Multiple-line messages read as a group without the lines blending when viewed from a distance. Linespace between two different messages is greater than between lines of the same multiple-line message group. Interline spacing should be approximately three-fourths the average of uppercase letter heights in adjacent lines of letters. The spacing to the top and bottom borders should be approximately equal to the average of the letter height of the adjacent line of letters. The lateral spacing to the vertical borders should be essentially the same as the height of the largest letter.

Color

Color is predetermined for most Service signs. The following considerations affect color choices for signs:

- *Color association* – The colors for many signs are determined by Federal standards, such as the *MUTCD* for traffic control signs and OSHA for safety-related signs. Consistent use of color increases the communicative value of signs with similar functions.
- *Backgrounds and borders* – Contrast between letter color and background is vital for reading a sign. It is easier to read a light letter color on a dark color background. Borders improve legibility by separating the sign legend from the environment behind the sign. With few exceptions, the *MUTCD* requires all signs to have a border of the same color as the lettering. A dark border should be set in from the edge, while a white border should extend to the edge of the panel. Consider indents if the sign is framed into a support system. The borders should be somewhat proportional; a smaller sign may have a 3/4" border while a large sign may have a 1 1/4" border to be visually relative to the letter size of the text.

Layout

The layout of information on a sign should work with letter size to draw attention to the sign. Using simple wording produces a clear message. Following are guidelines for arranging messages on a sign:

- Make separate signs for permitted and prohibited activities.
- Show destinations in the following sequence:
 - Straight-ahead arrows, lowest mileage first.
 - Left-turn arrows, lowest mileage first.
 - Right-turn arrows, lowest mileage first.
- Place straight-ahead arrows and left-turn arrows at the left margin.
- Place right-turn arrows at the right margin.
- Limit messages to four per sign.

Size

The manufacturer usually determines overall sign size. However, there are two occasions when a field station may request a particular size sign:

1. When the space a sign must fit into is limited, request the needed size.
2. When placing a sign under an existing one, it should be no wider than the existing sign.

If necessary, you can calculate sign size from the amount of text and the size of the letters, using the table on the next page. Top, bottom, and side margins should be at least the height of a lowercase letter. When measuring letter size, only use flat letters (abdefhiklmnpqrtvwxyz) because round letters (cgjoqsu) will not give you an accurate measurement. When calculating the sign size, remember to include spaces.

Letter and Space Calculation Table for Approximate Length of Legend

Multiply the number of letters used by the measure given to arrive at the length of line.

Helvetica Bold Letters

Uppercase	Lowercase	Multiply By...
2" height	1½" height	1⅝" per letter
2¾" height	2" height	2¼" per letter
3½" height	2½" height	2⅝" per letter
4" height	3" height	3⅛" per letter
5½" height	4" height	4⅜" per letter
8" height	6" height	6¼" per letter
10½" height	8" height	8⅝" per letter

Wood Routed – Helvetica

Uppercase	Lowercase	Multiply By...
1¼" height	⅞" height	1⅝" per letter
2½" height	1⅞" height	1¾" per letter
3⅝" height	2¾" height	2½" per letter
4¾" height	3½" height	3½" per letter
6" height	4⅞" height	5½" per letter
8" height	6" height	7" per letter

Arrows

Arrows must be used on all U.S. Fish and Wildlife Service signs in the guide category when needed to indicate direction. Arrows are available in sizes corresponding to letter height, but final decisions are left up to authorized fabricators for precise size of arrow on sign layout. The below graphic shows the dimensions of an arrow.

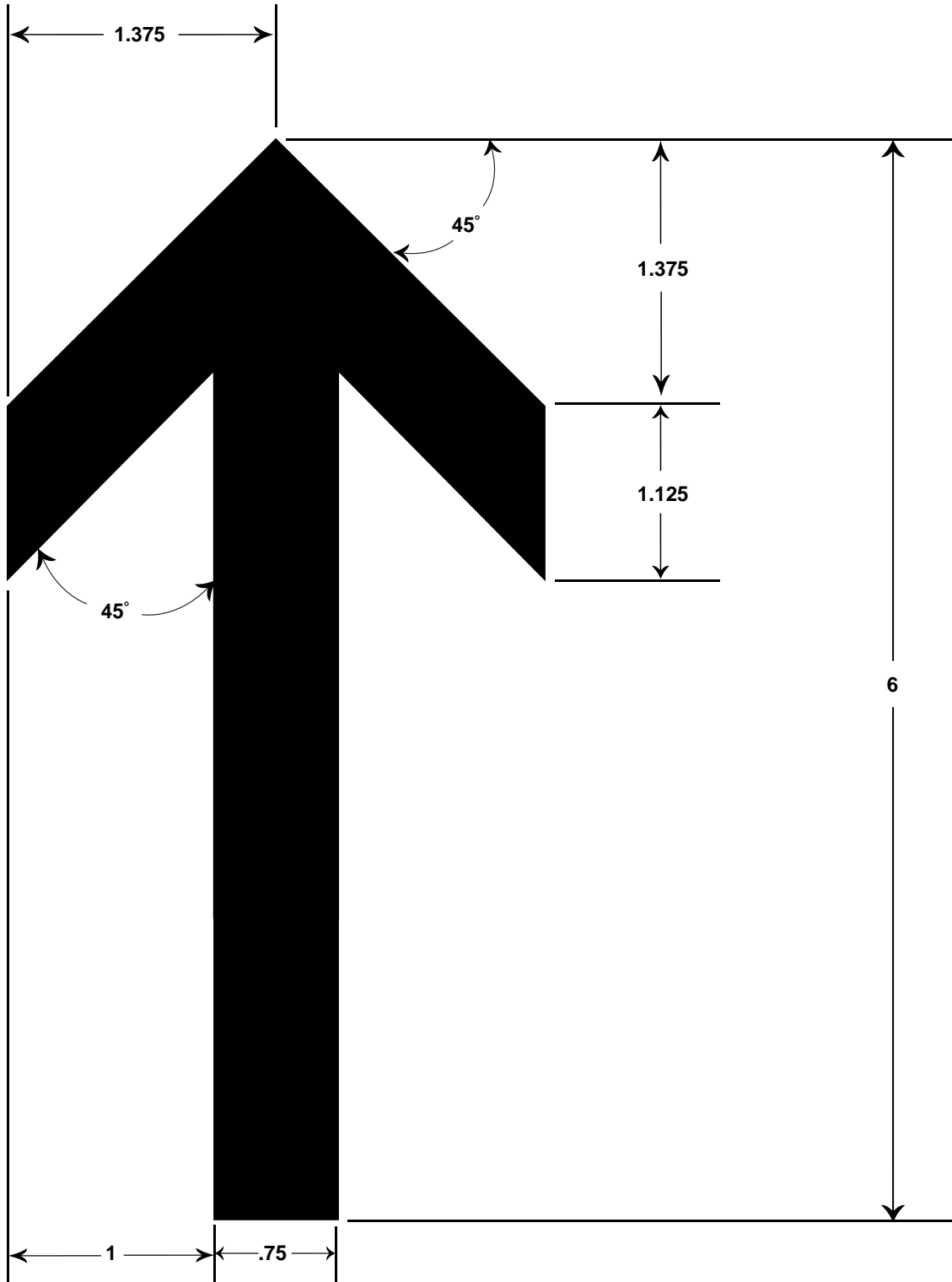

Conventional Road Guide Sign Sizes

Sign	Sign Designation	Section	Conventional Road	Minimum	Oversized
Interstate Route Sign (1 or 2 digits)	M1-1	2D.11	24 x 24	24 x 24	36 x 36
Interstate Route Sign (3 digits)	M1-1	2D.11	30 x 24	30 x 24	45 x 36
Off-Interstate Route Sign (1 or 2 digits)	M1-2,3	2D.11	24 x 24	24 x 24	36 x 36
Off-Interstate Route Sign (3 digits)	M1-2,3	2D.11	30 x 24	30 x 24	45 x 36
U.S. Route Sign (1 or 2 digits)	M1-4	2D.11	24 x 24	24 x 24	36 x 36
U.S. Route Sign (3 digits)	M1-4	2D.11	30 x 24	30 x 24	45 x 36
State Route Sign (1 or 2 digits)	M1-5	2D.11	24 x 24	24 x 24	36 x 36
State Route Sign (3 digits)	M1-5	2D.11	30 x 24	30 x 24	45 x 36
County Route Sign (1, 2, or 3 digits)	M1-6	2D.11	24 x 24	24 x 24	36 x 36
Forest Route (1, 2, or 3 digits)	M1-7	2D.11	24 x 24	18 x 18	36 x 36
Junction	M2-1	2D.13	21 x 15	21 x 15	30 x 21
Combination Junction (2 route signs)	M2-2	2D.14	60 x 48*	—	—
Cardinal Direction	M3-1,2,3,4	2D.15	24 x 12	24 x 12	36 x 18
Alternate	M4-1,1a	2D.17	24 x 12	24 x 12	36 x 18
By-Pass	M4-2	2D.18	24 x 12	24 x 12	36 x 18
Business	M4-3	2D.19	24 x 12	24 x 12	36 x 18
Truck	M4-4	2D.20	24 x 12	24 x 12	36 x 18
To	M4-5	2D.21	24 x 12	24 x 12	36 x 18
End	M4-6	2D.22	24 x 12	24 x 12	36 x 18
Temporary	M4-7,7a	2D.24	24 x 12	24 x 12	36 x 18
Begin	M4-14	2D.23	24 x 12	24 x 12	36 x 18
Advance Turn Arrow	M5-1,2,3	2D.26	21 x 15	21 x 15	—
Lane Designation	M5-4,5,6	2D.27	24 x 18	24 x 18	36 x 24
Directional Arrow	M6-1,2,2a,3,4,5,6,7	2D.28	21 x 15	21 x 15	30 x 21
Destination (1 line)	D1-1	2D.37	Varies x 18	Varies x 18	—
Destination and Distance (1 line)	D1-1a	2D.37	Varies x 18	Varies x 18	—
Circular Intersection Destination (1 line)	D1-1d	2D.38	Varies x 18	Varies x 18	—
Circular Intersection Departure Guide	D1-1e	2D.38	Varies x 42*	—	—
Destination (2 lines)	D1-2	2D.37	Varies x 30	Varies x 30	—
Destination and Distance (2 lines)	D1-2a	2D.37	Varies x 30	Varies x 30	—
Circular Intersection Destination (2 lines)	D1-2d	2D.38	Varies x 30	Varies x 30	—
Destination (3 lines)	D1-3	2D.37	Varies x 42	Varies x 42	—
Destination and Distance (3 lines)	D1-3a	2D.37	Varies x 42	Varies x 42	—
Circular Intersection Destination (3 lines)	D1-3d	2D.38	Varies x 42	Varies x 42	—
Distance (1 line)	D2-1	2D.41	Varies x 18	Varies x 18	—
Distance (2 lines)	D2-2	2D.41	Varies x 30	Varies x 30	—
Distance (3 lines)	D2-3	2D.41	Varies x 42	Varies x 42	—
Street Name (1 line)	D3-1,1a	2D.43	Varies x 12	Varies x 8	Varies x 18
Advance Street Name (2 lines)	D3-2	2D.44	Varies x 30*	—	—
Advance Street Name (3 lines)	D3-2	2D.44	Varies x 42*	—	—
Advance Street Name (4 lines)	D3-2	2D.44	Varies x 60*	—	—
Parking Area	D4-1	2D.47	30 x 24	18 x 15	—
Park - Ride	D4-2	2D.48	30 x 36	24 x 30	36 x 48
National Scenic Byways	D6-4	2D.55	24 x 24	24 x 24	—
National Scenic Byways	D6-4a	2D.55	24 x 12	24 x 12	—
Weigh Station XX Miles	D8-1	2D.49	78 x 60	60 x 48	96 x 72
Weigh Station Next Right	D8-2	2D.49	84 x 72	66 x 54	108 x 90
Weigh Station (with arrow)	D8-3	2D.49	66 x 60	48 x 42	84 x 78
Crossover	D13-1,2	2D.54	60 x 30	60 x 30	78 x 42
Freeway Entrance	D13-3	2D.46	48 x 30	48 x 30	—
Freeway Entrance (with arrow)	D13-3a	2D.46	48 x 42	48 x 42	—
Combination Lane Use / Destination	D15-1	2D.33	Varies x 96	Varies x 96	—
Next Truck Lane XX Miles	D17-1	2D.51	42 x 48	42 x 48	60 x 66
Truck Lane XX Miles	D17-2	2D.51	42 x 42	42 x 42	60 x 54
Slow Vehicle Turn-Out XX Miles	D17-7	2D.52	72 x 42	72 x 42	96 x 54

*The size shown is for a typical sign. The size should be appropriately based on the amount of legend required for the sign.

- Notes: 1. Larger signs may be used when appropriate
2. Dimensions in inches are shown as width x height

Regulatory Sign and Plaque Sizes (Sheet 1 of 4)

Sign or Plaque	Sign Designation	Section	Conventional Road		Expressway	Freeway	Minimum	Oversized
			Single Lane	Multi-Lane				
Stop	R1-1	2B.05	30 x 30*	36 x 36	36 x 36	—	30 x 30*	48 x 48
Yield	R1-2	2B.08	36x36x36*	48x48x48	48x48x48	60x60x60	30x30x30*	—
To Oncoming Traffic (plaque)	R1-2aP	2B.10	24 x 18	24 x 18	36 x 30	48 x 36	24 x 18	—
All Way (plaque)	R1-3P	2B.05	18 x 6	18 x 6	—	—	—	30 x 12
Yield Here to Peds	R1-5	2B.11	—	36 x 36	—	—	—	36 x 36
Yield Here to Pedestrians	R1-5a	2B.11	—	36 x 48	—	—	—	36 x 48
Stop Here for Peds	R1-5b	2B.11	—	36 x 36	—	—	—	36 x 36
Stop Here for Pedestrians	R1-5c	2B.11	—	36 x 48	—	—	—	36 x 48
In-Street Ped Crossing	R1-6,6a	2B.12	12 x 36	12 x 36	—	—	—	—
Overhead Ped Crossing	R1-9,9a	2B.12	90 x 24	90 x 24	—	—	—	—
Except Right Turn (plaque)	R1-10P	2B.05	24 x 18	24 x 18	—	—	—	—
Speed Limit	R2-1	2B.13	24 x 30*	30 x 36	36 x 48	48 x 60	18 x 24*	30 x 36
Truck Speed Limit (plaque)	R2-2P	2B.14	24 x 24	24 x 24	36 x 36	48 x 48	—	36 x 36
Night Speed Limit (plaque)	R2-3P	2B.15	24 x 24	24 x 24	36 x 36	48 x 48	—	36 x 36
Minimum Speed Limit (plaque)	R2-4P	2B.16	24 x 30	24 x 30	36 x 48	48 x 60	—	36 x 48
Combined Speed Limit	R2-4a	2B.16	24 x 48	24 x 48	36 x 72	48 x 96	—	36 x 72
Unless Otherwise Posted (plaque)	R2-5P	2B.13	24 x 18	24 x 18	—	—	—	—
Citywide (plaque)	R2-5aP	2B.13	24 x 6	24 x 6	—	—	—	—
Neighborhood (plaque)	R2-5bP	2B.13	24 x 6	24 x 6	—	—	—	—
Residential (plaque)	R2-5cP	2B.13	24 x 6	24 x 6	—	—	—	—
Fines Higher (plaque)	R2-6P	2B.17	24 x 18	24 x 18	36 x 24	48 x 36	—	36 x 24
Fines Double (plaque)	R2-6aP	2B.17	24 x 18	24 x 18	36 x 24	48 x 36	—	36 x 24
\$XX Fine (plaque)	R2-6bP	2B.17	24 x 18	24 x 18	36 x 24	48 x 36	—	36 x 24
Begin Higher Fines Zone	R2-10	2B.17	24 x 30	24 x 30	36 x 48	48 x 60	—	36 x 48
End Higher Fines Zone	R2-11	2B.17	24 x 30	24 x 30	36 x 48	48 x 60	—	36 x 48
Movement Prohibition	R3-1,2,3,4,18,27	2B.18	24 x 24*	36 x 36	36 x 36	—	—	48 x 48
Mandatory Movement Lane Control	R3-5,5a	2B.20	30 x 36	30 x 36	—	—	—	—
Left Lane (plaque)	R3-5bP	2B.20	30 x 12	30 x 12	—	—	—	—
HOV 2+ (plaque)	R3-5cP	2B.20	24 x 12	24 x 12	—	—	—	—
Taxi Lane (plaque)	R3-5dP	2B.20	30 x 12	30 x 12	—	—	—	—
Center Lane (plaque)	R3-5eP	2B.20	30 x 12	30 x 12	—	—	—	—
Right Lane (plaque)	R3-5fP	2B.20	30 x 12	30 x 12	—	—	—	—
Bus Lane (plaque)	R3-5gP	2B.20	30 x 12	30 x 12	—	—	—	—
Optional Movement Lane Control	R3-6	2B.21	30 x 36	30 x 36	—	—	—	—
Right (Left) Lane Must Turn Right (Left)	R3-7	2B.20	30 x 30*	36 x 36	—	—	—	—
Advance Intersection Lane Control	R3-8,8a,8b	2B.22	Varies x 30	Varies x 30	—	—	—	Varies x 36
Two-Way Left Turn Only (overhead)	R3-9a	2B.24	30 x 36	30 x 36	—	—	—	—
Two-Way Left Turn Only (post-mounted)	R3-9b	2B.24	24 x 36	24 x 36	—	—	—	36 x 48
BEGIN	R3-9cP	2B.25	30 x 12	30 x 12	—	—	—	—
END	R3-9dP	2B.25	30 x 12	30 x 12	—	—	—	—
Reversible Lane Control (symbol)	R3-9e	2B.26	108 x 48	108 x 48	—	—	—	—
Reversible Lane Control (post-mounted)	R3-9f	2B.26	30 x 42*	36 x 54	—	—	—	—
Advance Reversible Lane Control Transition Signing	R3-9g,9h	2B.26	108 x 36	108 x 36	—	—	—	—
End Reverse Lane	R3-9i	2B.26	108 x 48	108 x 48	—	—	—	—
Begin Right (Left) Turn Lane	R3-20	2B.20	24 x 36	24 x 36	—	—	—	—
All Turns (U Turn) from Right Lane	R3-23,23a	2B.27	60 x 36	60 x 36	—	—	—	—
All Turns (U Turn) with arrow	R3-24,24b,25,25b,26a	2B.27	72 x 18	72 x 18	—	—	—	—
U and Left Turns with arrow	R3-24a,25a,26	2B.27	60 x 24	60 x 24	—	—	—	—
Right Lane Must Exit	R3-33	2B.23	—	—	78 x 36	78 x 36	—	—

Regulatory Sign and Plaque Sizes (Sheet 2 of 4)

Sign or Plaque	Sign Designation	Section	Conventional Road		Expressway	Freeway	Minimum	Oversized
			Single Lane	Multi-Lane				
Do Not Pass	R4-1	2B.28	24 x 30	24 x 30	36 x 48	48 x 60	18 x 24	36 x 48
Pass With Care	R4-2	2B.29	24 x 30	24 x 30	36 x 48	48 x 60	18 x 24	36 x 48
Slower Traffic Keep Right	R4-3	2B.30	24 x 30	24 x 30	36 x 48	48 x 60	18 x 24	36 x 48
Trucks Use Right Lane	R4-5	2B.31	24 x 30	24 x 30	36 x 48	48 x 60	—	36 x 48
Keep Right	R4-7,7a,7b	2B.32	24 x 30	24 x 30	36 x 48	48 x 60	18 x 24	36 x 48
Narrow Keep Right	R4-7c	2B.32	18 x 30	18 x 30	—	—	—	—
Keep Left	R4-8,8a,8b	2B.32	24 x 30	24 x 30	36 x 48	48 x 60	18 x 24	36 x 48
Narrow Keep Left	R4-8c	2B.32	18 x 30	18 x 30	—	—	—	—
Stay in Lane	R4-9	2B.33	24 x 30	24 x 30	36 x 48	48 x 60	18 x 24	36 x 48
Runaway Vehicles Only	R4-10	2B.34	48 x 48	48 x 48	—	—	—	—
Slow Vehicles with XX or More Following Vehicles Must Use Turn-Out	R4-12	2B.35	42 x 24	42 x 24	—	—	—	—
Slow Vehicles Must Use Turn-Out Ahead	R4-13	2B.35	42 x 24	42 x 24	—	—	—	—
Slow Vehicles Must Turn Out	R4-14	2B.35	30 x 42	30 x 42	—	—	—	—
Keep Right Except to Pass	R4-16	2B.30	24 x 30	24 x 30	36 x 48	48 x 60	18 x 24	36 x 48
Do Not Drive on Shoulder	R4-17	2B.36	24 x 30	24 x 30	36 x 48	48 x 60	18 x 24	36 x 48
Do Not Pass on Shoulder	R4-18	2B.36	24 x 30	24 x 30	36 x 48	48 x 60	18 x 24	36 x 48
Do Not Enter	R5-1	2B.37	30 x 30*	36 x 36	36 x 36	48 x 48	—	36 x 36
Wrong Way	R5-1a	2B.38	36 x 24*	42 x 30	36 x 24*	42 x 30	30 x 18*	42 x 30
No Trucks	R5-2,2a	2B.39	24 x 24	24 x 24	30 x 30	36 x 36	—	36 x 36
No Motor Vehicles	R5-3	2B.39	24 x 24	24 x 24	—	—	24 x 24	—
No Commercial Vehicles	R5-4	2B.39	24 x 30	24 x 30	36 x 48	36 x 48	—	—
No Vehicles with Lugs	R5-5	2B.39	24 x 30	24 x 30	36 x 48	48 x 60	—	—
No Bicycles	R5-6	2B.39	24 x 24	24 x 24	30 x 30	36 x 36	24 x 24	48 x 48
No Non-Motorized Traffic	R5-7	2B.39	30 x 24	30 x 24	42 x 24	48 x 30	—	42 x 24
No Motor-Driven Cycles	R5-8	2B.39	30 x 24	30 x 24	42 x 24	48 x 30	—	42 x 24
No Pedestrians, Bicycles, Motor-Driven Cycles	R5-10a	2B.39	30 x 36	30 x 36	—	—	—	—
No Pedestrians or Bicycles	R5-10b	2B.39	30 x 18	30 x 18	—	—	—	—
No Pedestrians	R5-10c	2B.39	24 x 12	24 x 12	—	—	—	—
Authorized Vehicles Only	R5-11	2B.39	30 x 24	30 x 24	—	—	—	—
One Way	R6-1	2B.40	36 x 12*	54 x 18	54 x 18	54 x 18	—	54 x 18
One Way	R6-2	2B.40	24 x 30*	30 x 36	36 x 48	48 x 60	18 x 24*	36 x 48
Divided Highway Crossing	R6-3,3a	2B.42	30 x 24	30 x 24	36 x 30	—	—	36 x 30
Roundabout Directional (2 chevrons)	R6-4	2B.43	30 x 24	30 x 24	—	—	—	—
Roundabout Directional (3 chevrons)	R6-4a	2B.43	48 x 24	48 x 24	—	—	—	—
Roundabout Directional (4 chevrons)	R6-4b	2B.43	60 x 24	60 x 24	—	—	—	—
Roundabout Circulation (plaque)	R6-5P	2B.44	30 x 30	30 x 30	—	—	—	—
BEGIN ONE WAY	R6-6	2B.40	24 x 30	30 x 36	—	—	—	—
END ONE WAY	R6-7	2B.40	24 x 30	30 x 36	—	—	—	—
Parking Restrictions	R7-1, 2,2a,3,4,5,6,7,8, 21,21a,22,23, 23a,107,108	2B.46	12 x 18	12 x 18	—	—	—	—
Van Accessible (plaque)	R7-8P	2B.46	18 x 9	18 x 9	—	—	—	—
Fee Station	R7-20	2B.46	24 x 18	24 x 18	—	—	—	—
No Parking (with transit logo)	R7-107a	2B.46	12 x 30	12 x 30	—	—	—	—
No Parking/Restricted Parking (combined sign)	R7-200	2B.46	24 x 18	24 x 18	—	—	—	—
No Parking/Restricted Parking (combined sign)	R7-200a	2B.46	12 x 30	12 x 30	—	—	—	—
Tow Away Zone (plaque)	R7-201P,201aP	2B.46	12 x 6	12 x 6	—	—	—	—
This Side of Sign (plaque)	R7-202P	2B.46	12 x 6	12 x 6	—	—	—	—

Regulatory Sign and Plaque Sizes (Sheet 3 of 4)

Sign or Plaque	Sign Designation	Section	Conventional Road		Expressway	Freeway	Minimum	Oversized
			Single Lane	Multi-Lane				
Emergency Snow Route	R7-203	2B.46	18 x 24	18 x 24	—	—	—	24 x 30
No Parking on Pavement	R8-1	2B.46	24 x 30	24 x 30	36 x 48	48 x 60	—	36 x 48
No Parking Except on Shoulder	R8-2	2B.46	24 x 30	24 x 30	36 x 48	48 x 60	—	36 x 48
No Parking (symbol)	R8-3	2B.46	24 x 24*	30 x 30	36 x 36	48 x 48	12 x 12*	36 x 36
No Parking	R8-3a	2B.46	24 x 30	24 x 30	36 x 36	48 x 48	18 x 24	36 x 36
Except Sundays and Holidays (plaque)	R8-3bP	2B.46	24 x 18	24 x 18	—	—	12 x 9	30 x 24
On Pavement (plaque)	R8-3cP	2B.46	24 x 18	24 x 18	—	—	12 x 9	30 x 24
On Bridge (plaque)	R8-3dP	2B.46	24 x 18	24 x 18	—	—	12 x 9	30 x 24
On Tracks (plaque)	R8-3eP	2B.46	12 x 9	12 x 9	—	—	—	30 x 24
Except on Shoulder (plaque)	R8-3fP	2B.46	24 x 18	24 x 18	—	—	12 x 9	30 x 24
Loading Zone (plaque)	R8-3gP	2B.46	24 x 18	24 x 18	—	—	12 x 9	30 x 24
Times of Day (plaque)	R8-3hP	2B.46	24 x 18	24 x 18	—	—	12 x 9	30 x 24
Emergency Parking Only	R8-4	2B.49	30 x 24	30 x 24	30 x 24	48 x 36	—	48 x 36
No Stopping on Pavement	R8-5	2B.46	24 x 30	24 x 30	36 x 48	48 x 60	—	36 x 48
No Stopping Except on Shoulder	R8-6	2B.46	24 x 30	24 x 30	36 x 48	48 x 60	—	36 x 48
Emergency Stopping Only	R8-7	2B.49	30 x 24	30 x 24	48 x 36	48 x 36	—	48 x 36
Walk on Left Facing Traffic	R9-1	2B.50	18 x 24	18 x 24	—	—	—	—
Cross Only at Crosswalks	R9-2	2B.51	12 x 18	12 x 18	—	—	—	—
No Pedestrian Crossing (symbol)	R9-3	2B.51	18 x 18	18 x 18	24 x 24	30 x 30	—	30 x 30
No Pedestrian Crossing	R9-3a	2B.51	12 x 18	12 x 18	—	—	—	—
Use Crosswalk (plaque)	R9-3bP	2B.51	18 x 12	18 x 12	—	—	—	—
No Hitchhiking (symbol)	R9-4	2B.50	18 x 18	18 x 18	—	—	—	24 x 24
No Hitchhiking	R9-4a	2B.50	18 x 24	18 x 24	—	—	12 x 18	—
No Skaters	R9-13	2B.39	18 x 18	18 x 18	24 x 24	30 x 30	—	30 x 30
No Equestrians	R9-14	2B.39	18 x 18	18 x 18	24 x 24	30 x 30	—	30 x 30
Cross Only On Green	R10-1	2B.52	12 x 18	12 x 18	—	—	—	—
Pedestrian Signs and Plaques	R10-2, 3,3b,3c,3d,4	2B.52	9 x 12	9 x 12	—	—	—	—
Pedestrian Signs	R10-3a,3e,3f, 3g,3h,3i,4a	2B.52	9 x 15	9 x 15	—	—	—	—
Left on Green Arrow Only	R10-5	2B.53	30 x 36	30 x 36	48 x 60	—	24 x 30	48 x 60
Stop Here on Red	R10-6	2B.53	24 x 36	24 x 36	—	—	—	36 x 48
Stop Here on Red	R10-6a	2B.53	24 x 30	24 x 30	—	—	—	36 x 42
Do Not Block Intersection	R10-7	2B.53	24 x 30	24 x 30	—	—	—	—
Use Lane with Green Arrow	R10-8	2B.53	36 x 42	36 x 42	36 x 42	—	—	60 x 72
Left (Right) Turn Signal	R10-10	2B.53	30 x 36	30 x 36	—	—	—	—
No Turn on Red	R10-11	2B.54	24 x 30*	36 x 48	—	—	—	36 x 48
No Turn on Red	R10-11a	2B.54	30 x 36*	36 x 48	—	—	—	—
No Turn on Red	R10-11b	2B.54	36 x 36	36 x 36	—	—	—	—
No Turn on Red Except From Right Lane	R10-11c	2B.54	30 x 42	30 x 42	—	—	—	—
No Turn on Red From This Lane	R10-11d	2B.54	30 x 42	30 x 42	—	—	—	—
Left Turn Yield on Green	R10-12	2B.53	30 x 36	30 x 36	—	—	—	—
Emergency Signal	R10-13	2B.53	42 x 30	42 x 30	—	—	—	—
Emergency Signal - Stop on Flashing Red	R10-14	2B.53	36 x 42	36 x 42	—	—	—	—
Emergency Signal - Stop on Flashing Red (overhead)	R10-14a	2B.53	60 x 24	60 x 24	—	—	—	—
Turning Vehicles Yield to Peds	R10-15	2B.53	30 x 30	30 x 30	—	—	—	—
U-Turn Yield to Right Turn	R10-16	2B.53	30 x 36	30 x 36	—	—	—	—
Right on Red Arrow After Stop	R10-17a	2B.54	36 x 48	36 x 48	—	—	—	—
Traffic Laws Photo Enforced	R10-18	2B.55	36 x 24	36 x 24	48 x 30	54 x 36	—	54 x 36
Photo Enforced (symbol plaque)	R10-19P	2B.55	24 x 12	24 x 12	36 x 18	48 x 24	—	48 x 24
Photo Enforced (plaque)	R10-19aP	2B.55	24 x 18	24 x 18	36 x 30	48 x 36	—	48 x 36
MON—FRI (and times) (3 lines) (plaque)	R10-20aP	2B.53	24 x 24	24 x 24	—	—	—	—

Regulatory Sign and Plaque Sizes (Sheet 4 of 4)

Sign or Plaque	Sign Designation	Section	Conventional Road		Expressway	Freeway	Minimum	Oversized
			Single Lane	Multi-Lane				
SUNDAY (and times) (2 lines) (plaque)	R10-20aP	2B.53	24 x 18	24 x 18	—	—	—	—
Crosswalk, Stop on Red	R10-23	2B.53	24 x 30	24 x 30	—	—	—	—
Push Button To Turn On Warning Lights	R10-25	2B.52	9 x 12	9 x 12	—	—	—	—
Left Turn Yield on Flashing Red Arrow After Stop	R10-27	2B.53	30 x 36	30 x 36	—	—	—	—
XX Vehicles Per Green	R10-28	2B.56	24 x 30	24 x 30	—	—	—	—
XX Vehicles Per Green Each Lane	R10-29	2B.56	36 x 24	36 x 24	—	—	—	—
Right Turn on Red Must Yield to U-Turn	R10-30	2B.54	30 x 36	30 x 36	—	—	—	—
At Signal (plaque)	R10-31P	2B.53	24 x 9	24 x 9	—	—	—	—
Push Button for 2 Seconds for Extra Crossing Time	R10-32P	2B.52	9 x 12	9 x 12	—	—	—	—
Keep Off Median	R11-1	2B.57	24 x 30	24 x 30	—	—	—	—
Road Closed	R11-2	2B.58	48 x 30	48 x 30	—	—	—	—
Road Closed - Local Traffic Only	R11-3a,3b,4	2B.58	60 x 30	60 x 30	—	—	—	—
Weight Limit	R12-1,2	2B.59	24 x 30	24 x 30	36 x 48	—	—	36 x 48
Weight Limit	R12-3	2B.59	24 x 36	24 x 36	—	—	—	—
Weight Limit	R12-4	2B.59	36 x 24	36 x 24	—	—	—	—
Weight Limit	R12-5	2B.59	24 x 36	24 x 36	36 x 48	48 x 60	—	—
Weigh Station	R13-1	2B.60	72 x 54	72 x 54	96 x 72	120 x 90	—	—
Truck Route	R14-1	2B.61	24 x 18	24 x 18	—	—	—	—
Hazardous Material	R14-2,3	2B.62	24 x 24	24 x 24	30 x 30	36 x 36	—	42 x 42
National Network	R14-4,5	2B.63	30 x 30	30 x 30	36 x 36	36 x 36	—	42 x 42
Fender Bender Move Vehicles	R16-4	2B.65	36 x 24	36 x 24	48 x 36	60 x 48	—	48 x 36
Lights On When Using Wipers or Raining	R16-5,6	2B.64	24 x 30	24 x 30	36 x 48	48 x 60	—	36 x 48
Turn On Headlights Next XX Miles	R16-7	2B.64	48 x 15	48 x 15	72 x 24	96 x 30	—	72 x 24
Turn On, Check Headlights	R16-8,9	2B.64	30 x 15	30 x 15	48 x 24	60 x 30	—	48 x 24
Begin, End Daytime Headlight Section	R16-10,11	2B.64	48 x 15	48 x 15	72 x 24	96 x 30	—	72 x 24

* See Table 9B-1 for minimum size required for signs on bicycle facilities

- Notes: 1. Larger signs may be used when appropriate
2. Dimensions in inches are shown as width x height

Minimum Letter and Numeral Sizes for Expressway Guide Signs According to Interchange Classification

Type of Sign	Type of Interchange (see Section 2E.32)				Overhead
	Major		Intermediate	Minor	
	Category a	Category b			
A. Advance Guide, Exit Direction, and Overhead Guide Signs					
Exit Number Plaques					
Words	10	10	10	8	10
Numerals & Letters	15	15	15	12	15
Interstate Route Signs					
Numerals	18	—	—	—	18
1- or 2-Digit Shields	36 x 36	—	—	—	36 x 36
3-Digit Shields	45 x 36	—	—	—	45 x 36
U.S. or State Route Signs					
Numerals	18	18	18	12	18
1- or 2-Digit Shields	36 x 36	36 x 36	36 x 36	24 x 24	36 x 36
3-Digit Shields	45 x 36	45 x 36	45 x 36	30 x 24	45 x 36
U.S. or State Route Text Identification (Example: US 56)					
Numerals & Letters	18	15	15	12	15
Cardinal Directions					
First Letters	18	15	12	10	15
Rest of Words	15	12	10	8	12
Auxiliary and Alternative Route Legends (Examples: JCT, TO, ALT, BUSINESS)					
Words	15	12	10	8	12
Names of Destinations					
Upper-Case Letters	20	16	13.33	10.67	16
Lower-Case Letters	15	12	10	8	12
Distance Numbers	18	15	12	10	15
Distance Fraction Numerals	12	10	10	8	10
Distance Words	12	10	10	8	10
Action Message Words	10	10	10	8	10
B. Gore Signs					
Words	10	10	10	8	—
Numerals & Letters	12	12	12	10	—

Note: Sizes are shown in inches and where applicable are shown as width x height

Minimum Letter and Numeral Sizes for Expressway Guide Signs According to Sign Type

Type of Sign	Minimum Size
A. Pull-Through Signs	
Destinations — Upper-Case Letters	13.33
Destinations — Lower-Case Letters	10
Route Signs	
1- or 2-Digit Shields	36 x 36
3-Digit Shields	45 x 36
Cardinal Directions — First Letters	12
Cardinal Directions — Rest of Word	10
B. Supplemental Guide Signs	
Exit Number — Words	8
Exit Number — Numerals and Letters	12
Place Names — Upper-Case Letters	10.67
Place Names — Lower-Case Letters	8
Action Messages	8
Route Signs	
Numerals	12
1- or 2-Digit Shield	24 x 24
3-Digit Shield	30 x 24
C. Interchange Sequence or Community Interchanges Identification Signs	
Words — Upper-Case Letters	10.67
Words — Lower-Case Letters	8
Numerals	10.67
Fraction Numerals	8
Route Signs	
Numerals	12
1- or 2-Digit Shield	24 x 24
3-Digit Shield	30 x 24
D. Next XX Exits Sign	
Place Names — Upper-Case Letters	10.67
Place Names — Lower-Case Letters	8
NEXT XX EXITS — Words	8
NEXT XX EXITS — Number	12

Type of Sign	Minimum Size
E. Distance Signs	
Words — Upper-Case Letters	8
Words — Lower-Case Letters	6
Numerals	8
Route Signs	
Numerals	9
1- or 2-Digit Shield	18 x 18
3-Digit Shield	22.5 x 18
F. General Services Signs (see Chapter 2I)	
Exit Number — Words	8
Exit Number — Numerals and Letters	12
Services	8
G. Rest Area, Scenic Area, and Roadside Area Signs (see Chapter 2I)	
Words	10
Distance Numerals	12
Distance Fraction Numerals	8
Distance Words	8
Action Message Words	10
H. Reference Location Signs (see Chapter 2H)	
Words	4
Numerals	10
I. Boundary and Orientation Signs (see Chapter 2H)	
Words — Upper-Case Letters	8
Words — Lower-Case Letters	6
J. Next Exit and Next Services Signs	
Words and Numerals	8
K. Exit Only Signs	
Words	12
L. Overhead Arrow-Per-Lane and Diagrammatic Signs	
See Table 2E-5	

Note: Sizes are shown in inches and where applicable are shown as width x height

Minimum Letter and Numeral Sizes for Freeway Guide Signs According to Interchange Classification

Type of Sign	Type of Interchange (see Section 2E.32)				Overhead
	Major		Intermediate	Minor	
	Category a	Category b			
A. Advance Guide, Exit Direction, and Overhead Guide Signs					
Exit Number Plaques					
Words	10	10	10	10	10
Numerals & Letters	15	15	15	15	15
Interstate Route Signs					
Numerals	24/18	—	—	—	18
1- or 2-Digit Shields	48 x 48/ 36 x 36	—	—	—	36 x 36
3-Digit Shields	60 x 48/ 45 x 36	—	—	—	45 x 36
U.S. or State Route Signs					
Numerals	24/18	18	18	12	18
1- or 2-Digit Shields	48 x 48/ 36 x 36	36 x 36	36 x 36	24 x 24	36 x 36
3-Digit Shields	60 x 48/ 45 x 36	45 x 36	45 x 36	30 x 24	45 x 36
U.S. or State Route Text Identification (Example: US 56)					
Numerals & Letters	18	18/15	15	12	15
Cardinal Directions					
First Letters	18	15	15	10	15
Rest of Words	15	12	12	8	12
Auxiliary and Alternative Route Legends (Examples: JCT, TO, ALT, BUSINESS)					
Words	15	12	12	8	12
Names of Destinations					
Upper-Case Letters	20	20	16	13.33	16
Lower-Case Letters	15	15	12	10	12
Distance Numbers	18	18/15	15	12	15
Distance Fraction Numerals	12	12/10	10	8	10
Distance Words	12	12/10	10	8	10
Action Message Words	12	12/10	10	8	10
B. Gore Signs					
Words	12	12	12	8	—
Numeral & Letters	18	18	18	12	—

Notes: 1. Sizes are shown in inches and where applicable are shown as width x height
2. Slanted line (/) signifies separation of desirable and minimum sizes

Minimum Letter and Numeral Sizes for Freeway Guide Signs According to Sign Type

Type of Sign	Minimum Size
A. Pull-Through Signs	
Destinations — Upper-Case Letters	16
Destinations — Lower-Case Letters	12
Route Signs	
1- or 2-Digit Shields	36 x 36
3-Digit Shields	45 x 36
Cardinal Directions — First Letter	15
Cardinal Directions — Rest of Word	12
B. Supplemental Guide Signs	
Exit Number Words	10
Exit Number Numerals and Letters	15
Place Names — Upper-Case Letters	13.33
Place Names — Lower-Case Letters	10
Action Messages	8
Route Signs	
Numerals	12
1- or 2-Digit Shield	24 x 24
3-Digit Shield	30 x 24
C. Interchange Sequence or Community Interchanges Identification Signs	
Words — Upper-Case Letters	13.33
Words — Lower-Case Letters	10
Numerals	13.33
Fraction Numerals	10
Route Signs	
Numerals	12
1- or 2-Digit Shield	24 x 24
3-Digit Shield	30 x 24
D. Next XX Exits Sign	
Place Names — Upper-Case Letters	13.33
Place Names — Lower-Case Letters	10
NEXT XX EXITS — Words	10
NEXT XX EXITS — Number	15
E. Distance Signs	
Words — Upper-Case Letters	8
Words — Lower-Case Letters	6
Numerals	8
Route Signs	
Numerals	9
1- or 2-Digit Shield	18 x 18
3-Digit Shield	22.5 x 18
F. General Services Signs (see Chapter 2I)	
Exit Number Words	10
Exit Number Numerals and Letters	15
Services	10

Type of Sign	Minimum Size
G. Rest Area, Scenic Area, and Roadside Area Signs (see Chapter 2I)	
Words	12
Distance Numerals	15
Distance Fraction Numerals	10
Distance Words	10
Action Message Words	12
H. Reference Location Signs (see Chapter 2H)	
Words	4
Numerals	10
I. Boundary and Orientation Signs (see Chapter 2H)	
Words — Upper-Case Letters	8
Words — Lower-Case Letters	6
J. Next Exit and Next Services Signs	
Words and Numerals	8
K. Exit Only Signs	
Words	12
L. Overhead Arrow-Per-Lane Signs	
Arrowhead (Type D Directional Arrow)	21.625
Arrow Shaft Width	8
Arrow Height	
Through	72
Left Only	48
Right Only	48
Optional-Diverge (Through with Left or Right)	72
Optional-Split (Left and Right)	66
Vertical Separator Width	2
Vertical Space between Vertical Separator and Top of Nearest Arrow	8
Horizontal Space between Vertical Separator and Top of Nearest Through Arrow	15
Horizontal Space between Arrow Shaft and EXIT and ONLY plaques	10
EXIT and ONLY Panels	60 x 18
M. Diagrammatic Signs	
Arrowhead (Type D Directional Arrow)	13.5*
Lane Widths	5
Lane Line Segments	1 x 6
Spacing between Lane Line Segments	6
Stem Height to Upper Point of Departure	30
Horizontal Space between Arrowhead and Route Shield or Destination	12

* The size shown is the arrowhead width per lane depicted on the corresponding arrow shaft





Note: Sizes are shown in inches and where applicable are shown as width x height

2014 Traffic Sign Retroreflective Sheeting Identification Guide

This document is intended to help identify sign sheeting materials for rigid signs and their common specification designations. It is not a qualified product list. FHWA does not endorse or approve sign sheeting materials. Many other sheeting materials not listed here are available for delineation and construction/work zone uses.

Many sign sheeting materials have watermarks and/or patterns that are used to identify the material type and manufacturer. The watermarks shown in this guide have been enhanced. The watermarks will be less visible in practice and may not be present on smaller pieces of sheeting due to the spacing.

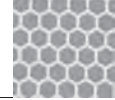
Retroreflective Sheeting Materials Made with Glass Beads

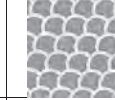
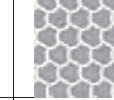
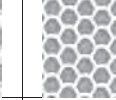
Example of Sheeting (Shown to scale)								
ASTM D4956-04	I	II	II	III	III	III	III	III
ASTM D4956-13	I	II	II	III	III	III	III	III
AASHTO M268-13	(1)	(1)	(1)	A	A	A	A	A
Manufacturer	Several companies	Avery Dennison®	Nippon Carbide	3M™	ATSM, Inc.	Avery Dennison®	Nippon Carbide	ORAFOL Americas Inc
Brand Name	Engineer Grade	Super Engr Grade	Super Engr Grade	High Intensity	High Intensity	High Intensity	High Intensity	ORALITE® High Intensity
Series	Several	T-2000	15000	2800 3800	ATSM HI	T-5500	N500	5800
NOTES:	(2) (8)	(3) (4) (9)	(4)	(3) (4) (9)	(4)	(4)	(4)	(4)

- 1) Sheeting material does not meet minimum AASHTO classification criteria.
- 2) Glass Bead Engineer Grade sheeting is uniform without any patterns or identifying marks.
- 3) Material no longer sold in the United States as of the date of this publication.
- 4) Section 2A.08 of the 2009 MUTCD (<http://mutcd.fhwa.dot.gov>) does not allow this sheeting type to be used for new legends on green signs.

- ASTM D4956-04 is referenced in Table 2A-3 of the 2009 MUTCD.
- ASTM D4956-13 is the most current ASTM sign sheeting specification (the 2013 version is designated by "-13").
- AASHTO M268-13 is the most current AASHTO specification (the 2013 version is designated by "-13").

Manufacturer Contact Information

3M - http://www.3M.com/roadwaysafety	ATSM, Inc. - http://www.atsminc.com
Avery Dennison - http://www.reflectives.averydennison.com	Nippon Carbide - http://www.nikkalite.com
ORAFOL Americas Inc. - http://www.orafolamericas.com	

FHWA Publication Number: FHWA-SA-14-022. You may download and print the electronic version of this document, available at www.fhwa.dot.gov/retro

2014 Traffic Sign Retroreflective Sheeting Identification Guide



This document is intended to help identify sign sheeting materials for rigid signs and their common specification designations. It is not a qualified product list. FHWA does not endorse or approve sign sheeting materials. Many other sheeting materials not listed here are available for delineation and construction/work zone uses.

Many sign sheeting materials have watermarks and/or patterns that are used to identify the material type and manufacturer. The watermarks shown in this guide have been enhanced. The watermarks will be less visible in practice and may not be present on smaller pieces of sheeting due to the spacing.

Retroreflective Sheeting Materials Made with Micro-Prisms

Example of Sheeting (Shown to scale)								
D4956-04	(5)	(5)	III, IV	III, IV, X	(5)	(5)	(5) / X	(5)
D4956-13	I	I	III, IV	III, IV	III, IV	III, IV	VIII	VIII
M268-13	(6)	(6)	B	B	B	B	B	B
Manufacturer	3M™	Avery Dennison®	Avery Dennison®	3M™	ORAFOL Americas Inc	Nippon Carbide	Nippon Carbide	3M™
Brand Name	EGP	PEG	HIP	HIP	ORALITE® HIP	HIM	Crystal Grade	Reflective Sheeting
Series	3430	T-2500	T-6500	3930	5900/5930	CRG 94000	CRG 92000	3940
NOTES:	(8)	(8)						

Example of Sheeting (Shown to scale)								
D4956-04	VIII	VII, VIII, X	IX	IX	(5)	(5)	(5)	(5)
D4956-13	VIII	VIII	IX	IX	IX	IX	XI	XI
M268-13	B	(7)	B	B	B	B	D	D
Manufacturer	Avery Dennison®	3M™	3M™	Avery Dennison®	Nippon Carbide	ORAFOL Americas Inc	3M™	Avery Dennison®
Brand Name	MVP Prismatic	Diamond Grade™ LDP	Diamond Grade™ VIP	OmniView™	Crystal Grade	ORALITE®	Diamond Grade™ DG3	OmniCube™
Series	T-7500	3970	3990	T-9500	95000	7900	4000	T-11500
NOTES:		(9)			(9)			

- 5) Material was either unavailable in 2005 (previous version of this Guide) or unassigned in the 2004 version of ASTM D4956.
- 6) Sheeting material does not meet minimum AASHTO classification criteria.
- 7) Material has been discontinued prior to AASHTO M268-10.
- 8) Section 2A.08 of the 2009 MUTCD (<http://mutcd.fhwa.dot.gov>) does not allow this sheeting type to be used for new yellow or orange signs, or new legends on green signs.
- 9) Material no longer sold in the United States as of the date of this publication.

Resources

Federal Highway Administration – <http://www.fhwa.dot.gov/retro>
 Manual on Uniform Traffic Control Devices (MUTCD) – <http://mutcd.fhwa.dot.gov>
 Texas A&M Transportation Institute – <http://tti.tamu.edu/visibility>
 ASTM – <http://www.astm.org> AASHTO – <http://www.transportation.org>

Sign Sheeting Products and Regulations

Rumors, Myths, and the Straight Facts

What is Sign Sheeting?



FACT:

A variety of sheeting materials can be used on traffic signs in order to provide appropriate visibility. They are retroflective and show the same color day and night. Each sheeting material has its own set of performance characteristics.

FACT:

For each of the last 25 years, 50 percent or more of the fatal crashes have occurred at night despite the lower volumes of traffic at night.



This document is intended as a brief reference to dispel misinformation that has become commonplace. By its nature, it does not contain all the information that may be needed to make appropriate decisions. Further information can be found in the FHWA July 20, 2006, memorandum entitled "Guidelines for Public Interest Findings and Certifications for Retroreflective Sign Sheeting" and the "Retro 101" presentation. Both of these are available from your local FHWA Division Office Safety Engineer.

The brochure is sponsored by:

FHWA Resource Center

www.fhwa.dot.gov/resourcecenter

FHWA National Retroreflectivity Team

www.fhwa.dot.gov/retro

FHWA Mid-Atlantic Safety Team



U.S. Department
of Transportation

**Federal Highway
Administration**



Reflection

The vast majority of roads are unlit. At night, drivers must rely heavily on what is revealed by their headlights. Retroreflective traffic control devices, such as pavement markings and signs, assist the driver by reflecting most of the light back toward the vehicle.

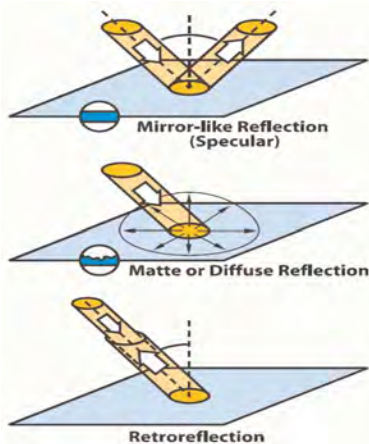

Sign sheeting should be retroreflective. The percentage of light returned is dependent not only on the sheeting material, but also the distance and angles between the headlamps, sign, and driver.

Rumor: A higher number ASTM Type means that type of sheeting is brighter than lower number ASTM types.

Answer: Myth

Some higher number Types are brighter than lower number Types. However, the type designation in ASTM D4956, Standard Specification for Retroreflective Sheeting for Traffic Control, is usually an indication of the order which it was added to the specification (e.g., Type III came along after Type II). However, there are exceptions; for instance, Types VII, VIII, and IX were introduced simultaneously.

Rumor: If a specification references an ASTM Type, that specification automatically provides for competition because any company would be able to manufacture it if they wished.

Answer: Myth

ASTM specifications by themselves do not ensure competition. If a company's new sheeting product meets a current ASTM D4956 Type, the company may market it as that particular ASTM Type, or they may try to convince ASTM to create a new Type that more narrowly defines their new product. In the past, newly added ASTM types were so narrowly defined that only one product could initially meet the criteria. Over time, other products were eventually developed to provide competition. As of publication, all sheeting types listed in ASTM D4956 (except Type VII) have multiple products that provide competition. See the FHWA Sheeting ID Guide at www.fhwa.dot.gov/retro.

It should be noted that a contract specification may further limit competition by requiring that a product also be on their approved product list or that the product have a certain number of years of testing under NTPEP (National Transportation Product Evaluation Program).

Rumor: The latest ASTM sheeting type specification is Type XI.

Answer: Myth

As of publication, the latest type designation added to ASTM D4956 was Type X. In 2006, a proposal was balloted to add a Type XI, but the proposal failed the ASTM balloting process.

Conceptual Model for Seeing Signs

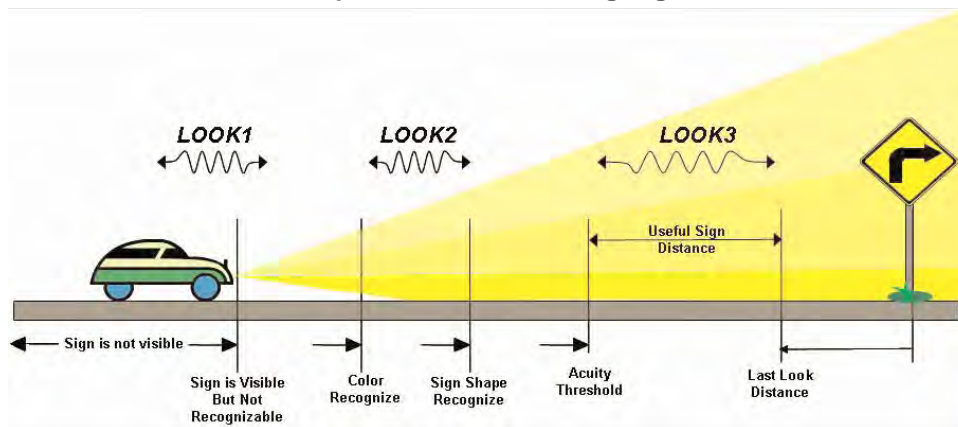

Lengths and distances of looks 1,2, & 3 will vary based on sheeting type, sign placement, and other factors such as letter size.

LOOK 1 => recognition of a target possibly related to the driving task (position of vehicle as shown)

LOOK 2 => driver assesses the target to determine if it is related to the driving task

LOOK 3 => the driver actually acquires the information on the sign

Between looks at the sign, the driver will look to the roadway for lane keeping and other obviously important driving tasks



Sign visibility is a general expression encompassing two specific terms: **detection** and **legibility**. For signs to be visible, they first need to be “detected.” Once they are detected, then they need to be “legible.”



Retroreflectometers are used to measure sign retroreflectivity.

Rumor: The voting members of ASTM are primarily government officials, and therefore, specifications are developed without industry influence.

Answer: Myth

Fifty percent of voting members of ASTM Committee D04.38 on Highway Traffic Control Materials are currently commercial interests (manufacturers, sign shops, contractors, etc.). The other fifty percent is composed of government officials, researchers, independent contractors and others. New specifications are developed by a subcommittee and brought to the full committee for approval by consensus.

Rumor: A brand name may be used in a specification on a Federal-aid project.

Answer: Fact

Using brand names on Federal-aid projects is acceptable and a simple way of stating what product is specified, as long as the proper procedures have been followed. Sometimes this is necessary, such as when a specific product is needed for synchronization with existing facilities or when an agency is willing to perform research that can be used to improve the state of the practice, or when only proprietary products meet specification requirements (e.g. a few years ago, only proprietary guardrail end treatments met NCHRP Report 350 requirements). These and other reasons are allowed for within the federal regulations. See the FHWA Construction Program Guide page regarding Patented and Proprietary Products at www.fhwa.dot.gov/construction/cqit/propriet.cfm.

Rumor: On a Federal-aid project, use of a specification that only one manufacturer currently meets still provides for competition as long as the specification is written such that other manufacturers have the opportunity to manufacture a product that would fall within that criteria.

Answer: Myth

If the product of only one manufacturer meets the specification, it is considered a proprietary specification and therefore compliance with 23CFR 635.411 must be assured. See the FHWA Construction Program Guide page regarding Patented and Proprietary Products at www.fhwa.dot.gov/construction/cqit/propriet.cfm.



Visual inspections made during daylight hours (as shown on the left) cannot accurately determine the nighttime performance (as shown on the right) of signs.





This photo illustrates differences in retroreflectivity between sheeting types.

FACT:

The driving population is aging and visual performance may decrease as a person ages. Drivers with decreased visual performance are less able to see the road, traffic control devices, and other traffic at night.

WHERE CAN I GET MORE INFORMATION?

www.fhwa.dot.gov/retro



U.S. Department of Transportation

Federal Highway Administration



Rumor: For projects without Federal-aid funding, use of a specification that only one manufacturer meets is acceptable.

Answer: Perhaps

As long as all State laws and those of appropriate agencies associated with the funding source are met, this is acceptable.

Rumor: If one FHWA Division approves a public interest finding (PIF) for a proprietary sheeting material, other Divisions should follow their lead.

Answer: Myth

An FHWA Division may approve a PIF for a variety of reasons, which may or may not exist in other States. For instance, research may indicate a high percentage of older drivers or some other unique driver or environmental characteristics in a particular State. As a result, there may be good reasons for consistent responses in some cases, and there may be very valid reasons for different responses in other cases. In some rare cases, FHWA may make a determination on a PIF at the agency level rather than delegate that responsibility to the Division.

Rumor: When two identical signs are viewed side by side at night, and one sign appears brighter than the other, drivers will be able to read the brighter sign from a farther distance.

Answer: Sometimes

Generally, brighter signs provide longer legibility distances, but the gains in legibility distance decrease as brightness increases. When side-by-side comparisons of signs are made during the nighttime, the differences in sign brightness can be clearly seen but the observed difference is not a good indication of sign performance or legibility, especially if the signs are fairly bright.

Rumor: Brighter is better for sign sheeting.

Answer: Usually

It is generally true that brighter signs are more conspicuous and legible (up to a certain point). However, in terms of conspicuity and legibility, incremental increases in brightness become less and less beneficial as the relative sign brightness increases.

Rumor: The minimum sign retroreflectivity Final Rule prohibits the use of Engineer Grade sheeting for STOP signs.

Answer: Myth

Engineer Grade (or Type I) may be used for all signs except:

- the white legend on guide signs,
- the white legend on street name signs, and
- all warning (yellow and orange) signs.

Even though a particular type of sheeting may initially meet the minimum retroreflectivity levels when new, it might quickly degrade to below the minimum retroreflectivity levels. The use of higher performance sheeting, even though it has a higher initial cost, might provide a better life-cycle cost for the agency.

Appendix 4

Guidelines for Use of Quick Response Codes (QRs)/Tags/NFC Chip Tags on U.S. Fish and Wildlife Signs

Definitions

QR Code – abbreviated from [Quick Response Code](#) – is a type of [matrix barcode](#) (or two-dimensional code) used for its fast readability and large storage capacity compared to standard [UPC barcodes](#). The code consists of black modules arranged in a square pattern on a white background. The information encoded can support virtually any kind of data. A smart phone ‘app’ is required to read a QR code.

Tag – a two-dimensional bar code created by Microsoft to use for mobile phone tagging. [Microsoft Tag](#) is a four-color variation of Microsoft’s “High-Capacity Color Barcode” (HCCB), which uses eight colored triangles to provide a capacity of approximately 3,500 alphabetic characters per square inch. A smart phone ‘app’ is required to read a Microsoft Tag.

NFC Chip Tag – [Near field communication](#) (NFC) is a set of standards for [smartphones](#) and similar devices to establish short-range radiocommunication triggered when two NFC-compatible devices are brought within close proximity, around four centimeters. NFC technology operates on the 13.56 MHz frequency, with data transfers of up to 424 kilobits per second. Applications include contactless transactions and data exchange. Communication is also possible between an NFC device and an unpowered NFC chip, called a “tag.”

Do not use QR codes, tags, or NFC chip tags on the following types of signs. Policy or law predetermines the design of these types of signs:

1. A-Series signs
2. Traffic control devices, such as a stop sign or yield sign
3. Safety signs
4. Entrance or welcome signs

You may place QR codes, tags, or NFC chip tags on the following types of signs:

1. Informational signs
2. Interpretive signs
3. Advance notice signs
4. Directional signs
5. Custom area management signs

Generic Guidance

The most important decision regarding the use of a QR code, tag, or NFC chip tag is connectivity at the site location. Poor connectivity is a factor if the intent of the code or tag is to provide immediately useful information, such as a site map, to visitors. Connectivity is not as much of a factor if the information provided is supplemental and viewed later.

When consider whether or not to use a QR code, tag, or NFC chip tag, choose what works best for the site. In many cases, advances in software may make this consideration moot.

You can use a QR code, tag, or NFC chip tag to provide visitors more detailed or additional information than what is normally available from a field station/site web page.

You may choose to use a QR/tag, for example, to offer a station map on an advance notice or directional sign, or you may use a QR code, tag, or NFC chip tag to explain an area management action. Using a QR code, tag, or NFC chip tag to explain the obvious will only frustrate visitors and build a perception that our codes/tags are frivolous.

In situations when a QR code, tag, or NFC chip tag is needed but not allowed on a sign, consider using a 3" × 4.5" size sign (similar to the A-18 easement sign) for the QR code, tag, or NFC chip tag. This works well when you want to use a code or tag with an A-Series sign. For example, if a station wants to provide contact information with a boundary sign, the 3" × 4.5" sign with the code or tag can go under the boundary sign and provide the link to the refuge.

As with any use of technology, it is a good idea to design signs such that these elements can be changed or removed if the technology trends change during the life of the sign.

Appendix 5

Sign Color Equivalents Chart

Color reference is the Pantone Matching System (PMS) printing inks. Below is a list of all the PMS colors on Service signs. The RGB and CMYK equivalents are only approximate and may change from vendor to vendor and by fabrication method.

Colors references are:

	Screenprint	RGB	CMYK
Blue (A-Series and Blue Goose)	Pantone 288C	0/44/118	100/92/25/14
Brown	Pantone 469C	97/54/29	40/73/89/49
Waterfowl Production Sign Green	Pantone 3308C	0/68/56	91/47/73/50
Desert/Prairie	Pantone 468C	222/211/176	14/7/36/0
Coastal Letters	Pantone Reflex Blue	0/37/150	100/95/7/3
Fee Sign	Pantone 871C	145/123/76	40/44/78/14

Appendix 6

U.S. Fish and Wildlife Service Recreational Symbols



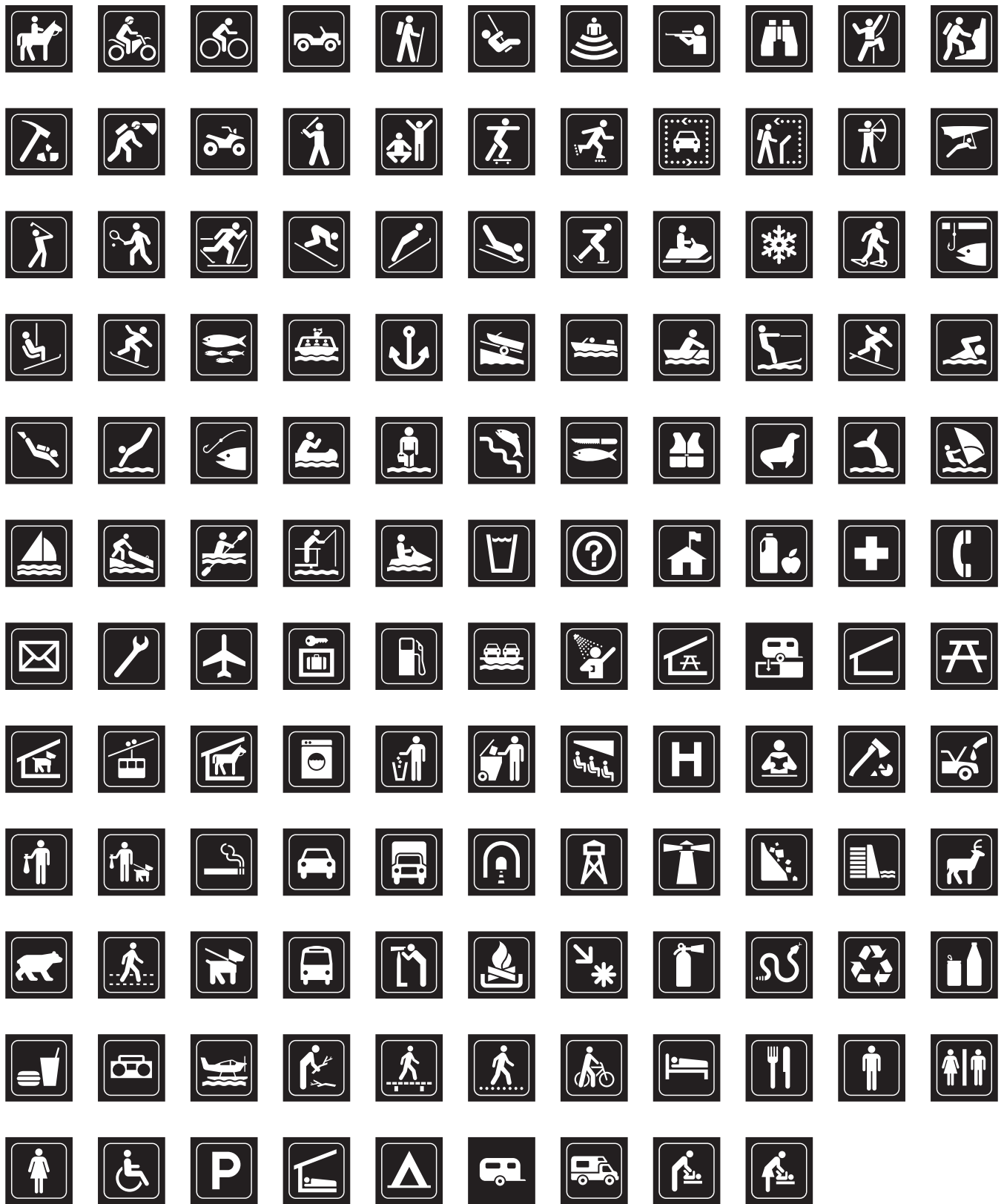





What's Inside

- Purpose of the Sign Planning Guide
- Why Do a Sign Plan?
- Assemble the Tools to Create a Sign Plan
- Visitor Services Review Questions for Sign Program
- Sign Inventory and Condition Assessment
- Creating a Sign Plan Document

Purpose of this Sign Planning Guide

This Sign Planning Guide will assist the person responsible for planning and maintaining signs at a National Wildlife Refuge or National Fish Hatchery. This guide provides a framework and process to produce a Sign Plan for your site. A good sign plan is the result of input from a variety of people, including the Project Leader, law enforcement personnel, maintenance staff, biologists, visitor services staff, and the Regional Sign Coordinator. Through planning, staff can establish the most effective way to communicate general information, regulations, and safety issues to the public.

Once created, the sign plan is a tool to welcome and orient visitors and ultimately to protect them and the natural resources.

Why Do a Sign Plan?

The primary intent of a sign plan is to provide the information needs of all visitors in a consistent manner. Good communication with our visitors requires the clear, concise delivery of an understandable message through an effective medium. Signs are one of the mediums used to convey information about the Service and our lands. Sometimes our signs may be our only formal contact with the visiting public, so it is important for them to be clear and well placed. Our goal should be to welcome our visitors and provide sufficient orientation so that the rules are clear and the area is easy to navigate by car, foot, or other means. Preparing a sign plan will help hatchery or refuge managers to organize, deliver, and maintain an effective sign program. Over decades, signs and their maintenance is a significant facility investment. A well-planned and maintained sign system will protect this investment and contribute to the quality of the visitor's experience.

Historically, signs were installed on an as-needed basis. This results in a wide variation in the look and effectiveness of the signs at many of our field stations. Sign clutter is prevalent at some field stations from various efforts over the years and previous versions of Service sign guidance. Even when signs are consistent with the current sign handbook, there can be confusion if no plan exists for making a site easy to navigate for the visiting public.

The primary benefit of having a sign plan is a consistent visual identity for the Service and effective communications with our visitors. Another benefit of a planned sign system is that provides consistency from one manager to the next. The field station prepares the sign plan and periodically updates it for maintenance, access, program, and facility changes occur. The sign program should be consistent with goals and objectives of broader station plans such as a visitor services plan and Comprehensive Conservation Plan. For example, if the boundaries of a closed area are modified in a CCP, then the signs associated with this change will need to be modified. The sign plan will be a valuable tool for tracking changes and identifying funding and sign program needs in annual work plans.

Planning for the Sign Plan

A sign plan is both a narrative document and a geospatial sign database. To create a sign plan, it is important to be familiar with the field management units and how they are seasonally used by visitors. One also needs to be familiar with the types of signs in the *Service Sign Handbook* and how they relate to the visitor and site. Collecting essential information, including sign location via GPS coordinates, sign type, a digital photo record, and sign condition will provide the building blocks for efficient management of the sign program data.

The key components used in creating a sign plan include:

- *Service Sign Handbook*: Complete graphic material and procedural standards.
- Station Comprehensive Conservation Plan or current station plan and visitor services plan and/or Visitor Services Review Report
- Sign Plan Map: A sign plan map(s) shows the approximate location of signs along boundaries, roadways, trails, and at all facilities. Ideally, this map is in a scalable GIS or web-based format.
- Sign Inventory and Maintenance Survey: A hard copy worksheet form or geospatial database created for inventory and maintenance of all signs. Once developed, use this system to periodically document sign conditions. Provides context and rationale for each proposed new sign or sign type or validates an existing sign. Typically record the maintenance information for each sign and any sign plan worksheet info on new proposed signs and locations and existing signs with GPS information and map location.

- Sign Photos: A digital photograph of the sign or sign type (in the case of Area Management-Boundary Signs).
- Many Service sites have a Central Federal Lands Highway Division Fish and Wildlife Road Inventory Program Report that has a road signs inventory with photographs and GPS locations. This could be very useful to jump start your sign plan.
- Sign Design and Layout: Staff will determine what information is required for each sign and send it to the Regional Sign Coordinator with the Sign Plan Worksheet for review and comment. In some Regions, the Regional Sign Coordinator may do a finished layout of the sign face and help with [Manual on Uniform Traffic Control Devices \(MUTCD\)](#) and other sign planning needs. The Regional Sign Coordinator may also help collect information and vendor quotes or answer other questions.

Visitor Services Review Questions for Your Sign Program

Conducting a Visitor Services Review is a great opportunity to evaluate your sign program and highlight deficiencies. Inviting regional office or other refuge visitor services staff to assist in your station review is a good way to get a fresh perspective on the effectiveness of your sign system. The following questions are from the [Visitor Services Handbook](#) and will help jump start your sign planning efforts.

- How do you determine the deficiencies of your sign program or decide when it is time to replace or maintain your signs? A sign plan or inventory will help answer these questions.
- What percentage of the signs and kiosk panels on site need to be replaced?
- Have you put a work order into SAMMS and tagged it as a Visitor Facility Enhancement (VFE) project to get funding for sign replacement?
- Are the sign components compatible with the surrounding landscape materials and building materials?

Boundary Signs and Area Management Signs (A-Series)

- Are refuge boundaries surveyed and properly marked?
- Are the boundary and/or area management signs properly maintained?
- Are the boundary and/or area management signs clearly visible to the visitor?
- Are the boundary and/or area management signs consistent with the guidelines in the *Service Sign Handbook*?
- Is the use of alternate signs, such as open and closed area signs, appropriate and correct?

Directional Signs

- Are off-site directional signs located to effectively direct visitors to the site, (often there are many ways to get to a site)? Reminder: the local department of transportation installs off-site directional signs.
- Are directional signs on site logically located so they provide visitors adequate time to make decisions while driving at recommended speeds?
- Are the signs in compliance with *Service Sign Handbook* standards?
- Do the directional signs meet the Federal Highway Administration's [Manual on Uniform Traffic Control Devices \(MUTCD\)](#) requirements and guidelines?
- If the answer is "no" to any of the above questions, what are the plans to correct the situation?

Entrance Signs

- Are all entrance signs well maintained, properly located, and in accordance with the *Service Sign Handbook*?
- If the entrance signs do not meet Service standards, what are the plans for replacement of these signs?

Signs and Communicating Important information to People with Disabilities

Your sign program must consider the many audiences we serve, including visitors with disabilities. Signs are critical in identifying accessible entrances, accessible trails, and other accessible facilities at a site. The sign program should use universal design principles and criteria (www.ncaonline.org/resources/tags/universal-design/index.shtml). The U.S. Fish and Wildlife Service views universal design as an aspirational goal for our programs and facilities; one which recognizes our broad diversity of users and aims to achieve inclusion of *all* our visitors. Providing visitors with clear information so they can easily determine where they can go and what they can do, and how to so safely, is primary.

Both [Title II of the Americans with Disabilities Act](#) and [Section 504 of the Rehabilitation Act](#) require Federal entities to develop transition plans for the removal of architectural and communication barriers to participation by people with disabilities. As you develop your sign plan, consider the requirements of a transition plan. Refer to www.ncaonline.org for more information on guiding principles, prioritizing barrier removal, and additional information on this topic. Your sign plan will be more comprehensive if you integrate this important requirement. Additional information can be found in the Architectural Barriers Act (www.access-board.gov/guidelines-and-standards) and Guidelines for Outdoor Recreation Areas (www.access-board.gov/guidelines-and-standards/recreation-facilities/outdoor-developed-areas).

Sign Inventory and Condition Assessment

The inventory/condition survey and development of a sign plan is a multi-step process. Use the Sign Inventory/Maintenance Form or a [geospatial database \(app\)](#) to record the following data:

Step 1: Photograph Sign and Establish its GPS Coordinates

For asset management and maintenance purposes, photograph and capture the GPS coordinates of each sign. Also, record the coordinate system and datum used. Latitude/longitude geographic coordinates using the WGS84 datum is recommended. Data should be stored and managed in a geospatial system (GIS or Web-based).

Step 2: Record Sign Attributes in a Database

Sample sign attributes are in the Inventory/Maintenance Survey Form at the end of this document. You can also use a [sign inventory app](#) that records photo, location and attributes using a mobile device. Sign attributes sign assembly, assembly type, post material, assembly configuration (double face or single), panel size, and size. The sign panel description is the number of panels per assembly with description of each based on sign sizes, grids, sign material. Mounting and installation footing type includes the footing size, mounting height (HAGL), grade changes, setback, and installation status (planned, ordered, installed, or maintained). See codes below.

Sign Inventory/Maintenance Survey - Station:

										Today's Date:		Next Review Date:			
				Unit/Map Grid/GPS - Sign Type Code - Sign #						Sign Size		Reflective <input type="checkbox"/> Yes <input type="checkbox"/> No		Letter Size	
				Action Required	Priority	Sign Material	Structure Material	Automobile or Pedestrian Sign	Road Type	Viewing Distance	Traffic Speed Limit	Meets MUTCD Requirements <small>(check single break-away posts, letter size)</small>	MUTCD Traf. Sign Type #	MUTCD	Watercraft Sign
Narrative comments about sign condition, supports, legend, or changes needed.															

Step 3: Create a Sign Plan Map

A map is a key component of the sign plan. The map(s) should include the refuge boundary and all roadways, trails, signs, and facilities. The map should be scalable, or if hard copy, at a scale in which all features can be easily distinguished. Signs or new sign locations should be clearly labeled with a unique sign identification code that connects the sign feature on the ground to information (metadata) associated with that sign. Format the map so that a printable hard copy can be produced for an existing condition inventory and condition assessment or for sign planning purposes.

An existing sign and condition survey identifies what is currently on the ground, and it is an important part of developing a sign plan. *The inventory should not dictate the direction of a new sign plan.*

It is helpful to add narrative comments about sign condition, supports, legend, or changes needed.

To complete the sign inventory map, establish those areas where a close-up view may be needed to accommodate the many signs in place, such as for small public areas or headquarters areas. By way of illustration, following is an example close-up view area map of a site that has many signs.

Sign Plan Map Samples

This illustration is for example only.

These maps show how a site is identified as Areas or refuge Units for survey and planning.

- BK Brick Area
- BN Barnegat Bay North Unit
- BS Barnegat Bay South Unit
- EH Egg Harbor Unit
- BR Brigantine Unit
- HQ Headquarters Unit
- AWT Akers Woodland Trail Area
- LET Leeds Eco-Trail Area
- FWD Forsythe Wildlife Drive Area

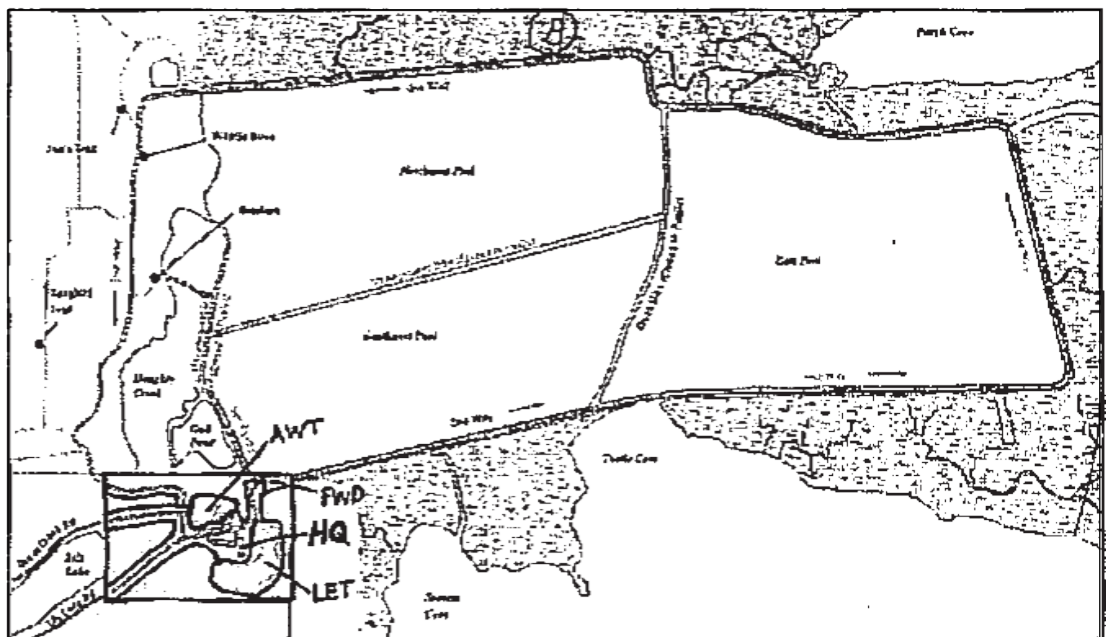
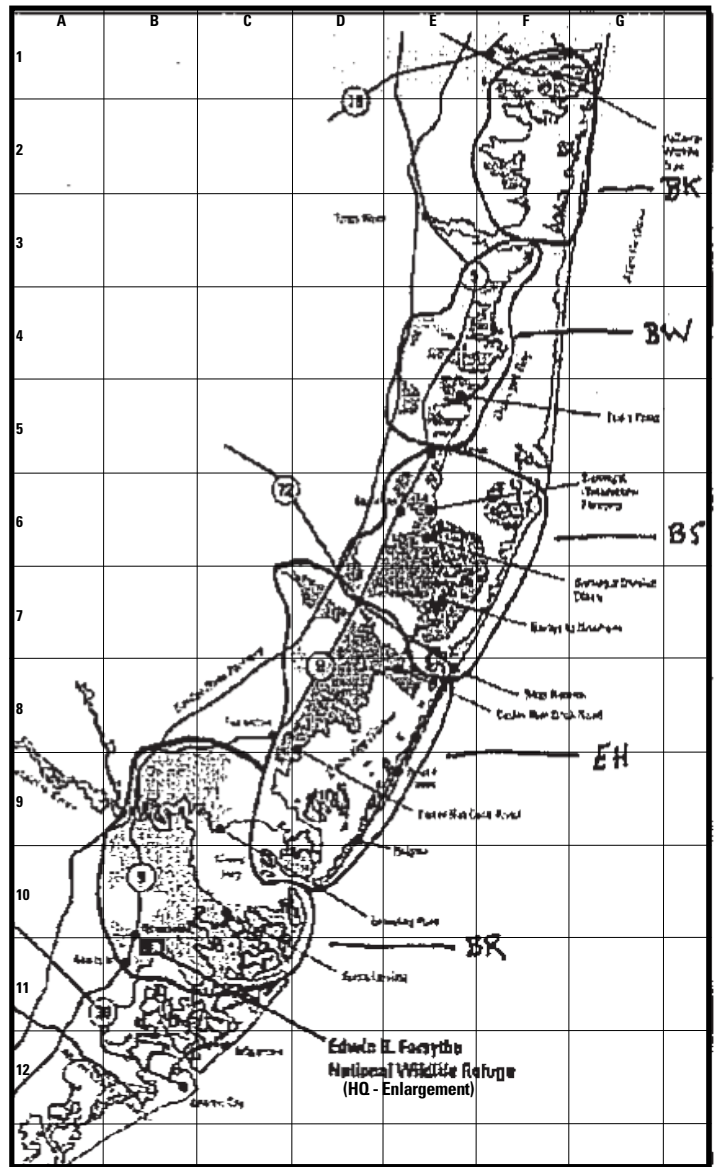

HQ/AWT/LET/FWD - Enlargement

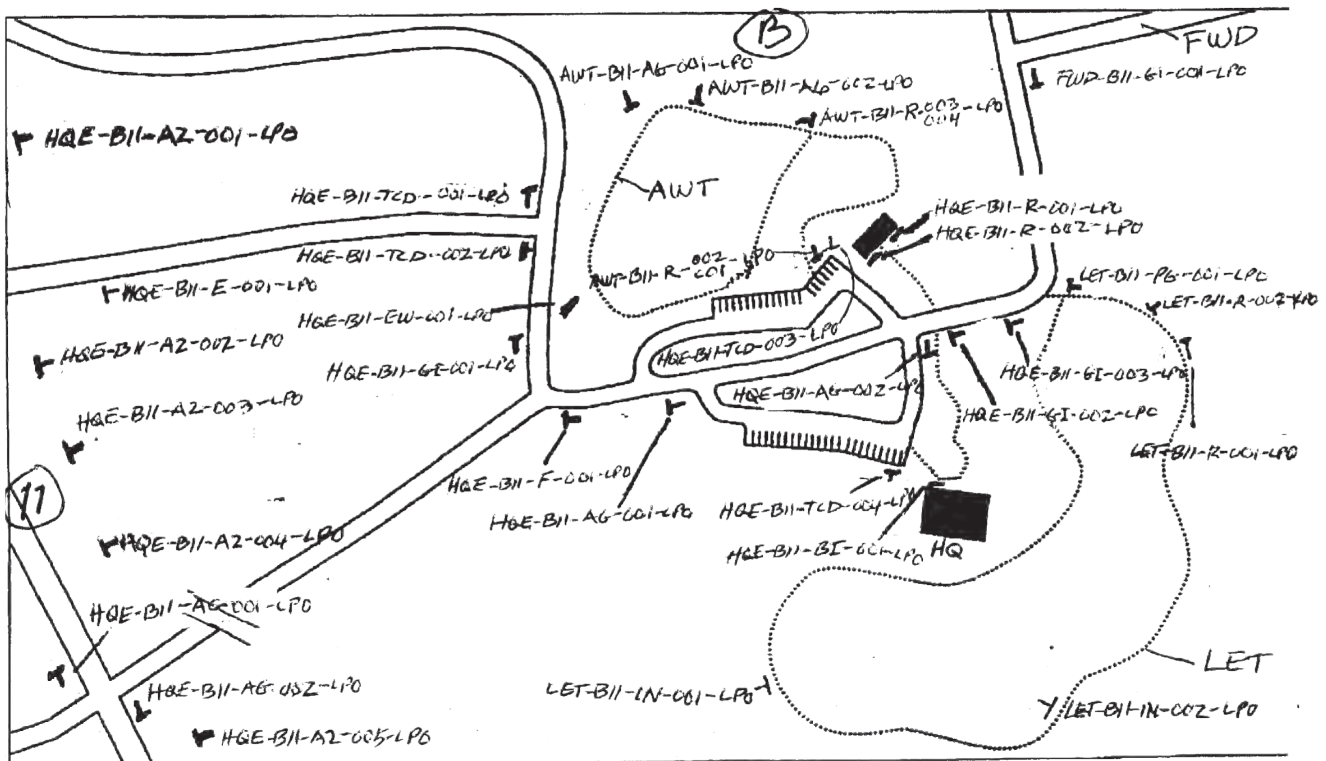

HQ/AWT/LET/FWD – Enlargement depending on the number of signs. Each unit or subsection may need its own enlarged area to accommodate sign details. Once complete, the information would also be in a spreadsheet and on digital maps.

In making a comprehensive inventory/maintenance survey, check listed items and fill out all appropriate sections, (identify the sign type using the *Service Sign Handbook*).

- Photograph signs and attach to the Existing Conditions Sign Inventory Form/Worksheet when assembling this survey.
- Record the condition and recommendations for upgrades in section 4 of the worksheet. Base those recommendations on the following questions: Does the sign fulfill a need? Is it necessary?
- Is the sign compliant with Service standards? Is the sign located for optimal effectiveness? Is the legend big enough to read? If not, what size should it be?
- If replaced, how can this installation be more effective? Can the message be incorporated into another sign for greater effectiveness? Note: a survey would include the location of Area Management Signs. No need to prepare an individual form (and photo) for each Boundary or Designated Area Sign. You can include just a typical example of these types of signs. However, knowing where the signs are located (GPS coordinates) does help with maintenance inspections.

Sign Plan Map Code Classification

Documentation of signs and their attributes in mapped form will require a coding system based on the Service sign standards and sign types. These characteristics are summarized in a sign identification code number. There are three parts to a complete identification code; each made up of a series of numbers or letters that describe the attributes of this installation and include:

- Service sign type code
- Individual sign number
- Site name/abbreviation

The value of a sign code system is that it allows the entire database for a sign plan to be maintained in computerized format. This enables all functions from planning, budgeting, ordering, installing, maintaining, and updating to be traced with a minimum amount of effort.

Sign Identification Code Number: This number is made up of a: sign site location, sign type code, individual sign number, and site abbreviation.

An example of the code on the above map is (prefix HQE)-B11-E-001-LPO, in this case:

- HQE identifies the sign location as the site headquarters entrance area; B11 is the map grid number where the sign is located; E is the sign type code, in this case “E” is for “entrance” sign; and 001 is the first sign of this type in that unit and grid number.

Service Sign Type Codes (Based on Sign Handbook)

The types of signs described in the *Sign Handbook* should address the full complement of sign types used on the field station site. These include the following sign types:

Sign Type categories and abbreviations are listed below:

1. Standard Entrance Sign = E
The refuges’ standard includes the Blue Goose symbol. Other divisions would not use the Blue Goose.
 - 1a. Standard Entrance Footer = EF
 - 1b. Standard Entrance Welcome Sign = EW
(See *Handbook* [pages 5-1/2](#) for examples of this type of signage)
2. Custom Facility Sign = CF
These may be custom entrance signs, complex-facility identification signs, or custom visitor-center identification signs
3. Traffic Control Device = TCD
Example: A stop sign code would be =TCD/R1-1 (from the UNICOR catalog), which corresponds with approved MUTCD codes for a stop sign of a certain size.
Note: There are many categories of [MUTCD](#) traffic control device signs. See [page 2-4 Traffic Control Devices](#) for entire list..
(See *Handbook* [page 5-30](#) for examples of these categories of signage)
4. Area Management Signs = A
There are many area management signs, and each should be numbered.
 - 4a. Boundary signs, A2 is typical.
 - 4b. Area Management Signs. Area closed signs are just one type, with A6 or A7 as examples. There are other messages listed in the “A” series sign guide).
(See *Handbook* [page 5-6](#) for examples of this type of signage)
5. Standard Information Signs
Information signs alert visitors of services, activities, or opportunities at a site.
 - 5a. General Information Signs = GI (general or regulatory information, which could use international symbols with text on them)
 - 5b. Concession Signs = CI (these include fee information, or Friends concession information)
 - 5c. Building Identification Signs = BI (this type of sign along with entrance signs, can include a Service logo with the Building ID information)
(See *Handbook* [page 5-16](#) for examples of this type of sign)
6. Guide Signs
Used on Service property to lead visitors to destinations on site either via vehicle or as a pedestrian.
 - 6a. Auto Guide signs = AG
 - 6b. Pedestrian Guide signs = PG
(See *Handbook* [page 5-21](#) for examples of this type of sign)

Advanced Notice/Guide Traffic Signs = AN
(See *Handbook* [page 5-23](#) for examples of this type of sign)
7. Interpretive Signs = IN
Identify custom interpretive signs either standing alone, at a wayside, or in a kiosk. There is no standard “look” to an interpretive sign. They should all relate to each other with consistent design features that make them a unique “family” of signs.
(See [Appendix 10](#) for more information and examples of interpretive signs)

8. Service Logo/Decals = SL
This is the official Government emblem of our agency and the [Service Manual](#) addresses the uses for the logo/emblem. The logo is on the standard entrance signs and may be on building identification signs and vehicles, but not be on most other signs. It can be a decal or a dimensional material, reflective or not, determined by the context in which it is used. (See Handbook [page 5-25](#) for examples of this type of sign)
9. Fee Area Sign/Logo = F
Fee symbols generally with regulatory information concerning fees or other site uses. (See Handbook [page 5-28](#) for examples of this type of sign/logo)
10. Recreation Symbols/Icons = R
Similar to international symbols, the Service has a selected group of recreational icons for Service standard use at Service sites, either individually or with other categories of signs. (See [Appendix 6](#) for the quick guide to Icons for Service signs)
11. Safety Signs = S
There are several categories of safety signs per OSHA regulations at [CFR 29, Part 1910](#). (See Handbook [page 5-31](#) for examples of this type of sign)

Creating the Sign Plan Document

The sign plan includes the visitor communication goals, objectives, and strategies for the field station with enough detail to design, order, install, and maintain signs on Service lands. Also provided is information for signs that are located off Service lands and installed by State or county agencies. Liability for off-site signs needs to be the responsibility of the agency having jurisdiction to meet [MUTCD](#) safety requirements.

We recommend that staff review the plan with someone who is not familiar with the location to ensure that it addresses the needs of a first-time visitor and that signs are located at key locations in which the information will be most useful.

Sign Plan Document Outline/Format:

- a) Description of Area
- b) Scope of the Project
- c) Relevant CCP or VSP Goals and Objectives
- d) Sign Plan Objectives (New)
- e) Sign Selection and Placement Criteria
- f) Sign Recommendations: Strategies and Needs
- g) Other Considerations
- h) Sign Plan Map (Existing and Proposed Signs)
- i) Sign Artwork and Layout
- j) Funding Requirements
- k) Sign Planning Worksheets and Inventory Forms
- l) Accessibility as appropriate

Additional Information for each section of the Sign Plan:

- A. Description of the Area. Provide a general description of the refuge, hatchery, and any management units referenced in the sign plan.
- B. Scope of Project. Describe the scope of the sign plan. Is it for a subunit? Is it for a complex?
- C. Relevant CCP or VSP Goals and Objectives. The first step in the development of the new sign plan is to review the CCP or Visitor Services Stepdown plan. If a visitor services review was conducted, refer to that

report and any notes/issues highlighted that relate to signs. Consider these documents for any relevant information to the sign plan, such as visitor types, visitor estimates, etc.

D. Sign Plan Objectives. Identify new visitor communication objectives.

E. Sign Selection and Placement Criteria:

1. What does the visitor need to know? A rule of thumb is that you only provide enough information to take the visitor to the next decision point. Place rules about a general area at the entrance or entrance points. Place a rule specific to a condition or access point at that location, perhaps an A-series sign. Place information where it will be most helpful. Welcome/Orientation kiosk locations serve as the best general information area.
2. What is the best way to present this information? Service standards address most applications, so you have limited selections relating to sign types to display messages. Variation of general rules and regulations for diverse sites can be best accomplished with the display of general site-specific rules or instructions at a Welcome/Orientation area/kiosk.
3. What is the context? Will the visitor be a driver, pedestrian, both? These functions are generally separate. For a motorist, signs should be on the driver's right side. Place pedestrian signs based on ease of view. Post all signs to minimize sign clutter, providing only the essentials for safe and non-intrusive use of the public facilities at a field station.
4. At what speed will the visitor be driving? Size all signs relative to the distance at which they are viewed and the needed response time. Highway signs require legends (initial capital letters) that are a minimum of 4" for roads with 35-45 mph posted limits and 6" for 45 mph roads. Signs on roads within a field station are generally posted at 20 mph or slower, and can be 3" to 4" depending on application. (Check with your Regional Sign Coordinator for [MUTCD](#) requirements as there are different categories of roadways that give some flexibility on the sizes required.)

Effective signs must:

1. Fulfill a need.
2. Command the attention and respect of the user.
3. Convey a simple, clear message.
4. Give adequate time for the proper response.

To fulfill these requirements, four basic considerations should be addressed:

1. Uniformity of sign types: Treat similar situations in the same way. For example, fee requirements, fee payment, parking control, and general rules have greater authority and effectiveness if they are visually consistent at all sites in a Region or nationwide. If inconsistent or not easily understood, visitors traveling can become confused or may choose to ignore signs.
2. Design of sign types: Combine features such as size, contrast, color, shape, and reflectivity to draw attention to the sign. Shape, size, color, and simplicity of message should produce a clear meaning, and legibility and size combined with placement must permit adequate time for driver response. Note that these requirements are incorporated into each type of sign, but that the sign should be of adequate size for each specific location and purpose. The goal is to make the sign as small in the natural environment as possible, while still ensuring that it is readable by the motorist and/or pedestrian.
3. Sign placement:
 - a) On-site locations: Careful placement ensures that the sign is within sight of the user so that it will command attention. A driver traveling at normal speed should have enough time to safely respond. A general rule is that a sign viewed from a vehicle is placed on the motorist's right side, within the cone-of-vision. Most signs are placed perpendicular to a viewer's approach, and pedestrian-oriented signs may require a double-face installation if viewed from both directions. Place a regulation or instructional sign in relation to the site or condition to which it applies. If the message applies to a large area, the information may be presented at a common entry, with smaller signs strategically placed to confirm visitor compliance where needed.

- b) Off-site locations: Off-site placement is the responsibility of the State or county who has jurisdiction of the site where you want your sign. Service staff should not place off-site signs without State or county approval. Although in most cases, you'll have to order the sign and partner with the proper authority to have it placed. If you are ordering a sign, you need to know the road classification where it will be placed to make sure it will comply with [MUTCD](#) requirements. If the State or county is making the sign, make sure they are notified that it must comply with [MUTCD](#) requirements for that location. Not following these guidelines opens the Service up to liability issues should someone be hurt by a misplaced sign, a sign that's the wrong size, or one where there's not enough response time.
4. Operation: The right sign must be installed to meet the traffic requirements at a given location; it must be placed in a uniform and consistent manner so motorists will properly respond to it based on their previous exposure to similar traffic control situations. Fee collection information or trail use procedures should be consistent onsite for optimal effectiveness. The goal is to create a safe facility using signage as the primary communication tool.

F. Sign Recommendations: Strategies and Needs:

Sign locations determine message content:

1. At Entrances – All major entry points to the site (generally from a vehicle) must have an appropriate entrance sign and/or secondary welcome sign with potentially no more than 2-3 other high priority guide, regulation, or symbol messages communicated.
2. Welcome/Orientation Kiosk – We recommend that this sign be as brief as possible and that messages be grouped for easy reading and augmented with the appropriate recreation symbol. A longer display of all field station regulations can be displayed at an information kiosk.
3. At a trailhead – At the beginning of a nature trail, there may be more than one instruction panel. Grouping icons in conjunction with the trailhead guide sign or trailhead identification sign will help to reduce the number of signs placed in the environment. Trail accessibility information can be found in [ABA 1017.10](#).
4. Along a trail or path – a regulatory message can be placed with a single specific icon/symbol sign (regulation/prohibition) or an A-series sign that confirms a rule the visitor was informed of at the information kiosk. The sign might also explain that the location has an area management status visitors should note. It is difficult for first-time visitors to internalize a regulation from a general kiosk panel to a specific location on your site, and you may need additional signage as a result. Try to keep it to the minimum necessary for compliance. Trails are ideal for interpretive signs and waysides and place them strategically to pique a visitor's interest.
5. At the edge of the water – In this case, a location-specific regulation sign can be used to inform visitors of the rules, for example, at a boat launch area.

Sign Materials, Assembly, Structures, and Mounting

An overview of materials and structural options that are applicable to signing on Service lands and related Service facilities follows:

- Panels finished front and back to create a quality installation.
- Tamper-resistant hardware or concealed attachment points to minimize vandalism where possible.
- Use materials with the longest possible life cycle. Life cycle requires that the sign look good in the final years of the installation.
- Use materials that are sustainable, if possible. Some recyclable structural materials may be available, and you should select products with the longest life. For example, weathering Korten steel posts may be preferable to a treated wood post (typical for most sites). Cost is an obvious factor in this consideration, but steel will last many times longer, and does not discharge toxic materials in the ground.
- Use materials that are appropriate to the installation. A beautifully crafted, routed entrance sign made with western red cedar may be great at an entrance. Make secondary standard signs from durable flat sign materials (typically High Density Overlay (HDO) plywood with current [MUTCD](#) reflectivity vinyl

standards applied). A-series boundary signs are screen printed or vinyl on aluminum. Single editions or signs made in quantities of one to ten units are available from some vendors when required. Aluminum signs will fade or are damaged, but they can be recycled.

- Mounting and structures must be engineered to withstand both local requirements for frost heave and wind loading based on 2005 American Society of Civil Engineering standards. You may need the Regional Office Engineering staff to help with a large project, kiosk, or for a large sign in windy areas.

G. Other Considerations: Sign Panel Materials Overview

Following is a list of sign materials recommended for signing field stations:

- Aluminum or polycarbonate with retroreflective/vinyl surface.
- HDO with retroreflective background and computer cut retro-reflective legend.
- High Pressure Laminate (HPL) with digitally printed graphics.

Sign structures:

- Masonry with monolithic stone or cast concrete with wood or steel uprights.
- Concrete footing with baseplate.
- Treated timbers or dimensional lumber, with breakaway feature.
- Weathered steel posts.
- Direct embedment with stabilizer blade.

H. Sign Plan Map with New/Proposed Sign Locations and Sign Types/Content

Become familiar with the sign standards so that you can select the proper sign for each particular application and create an orderly and consistent sign plan. Use the notes and observations from the existing conditions survey to help create a plan. If existing signs need to be replaced, only do so if they are the most appropriate signs for a particular location or purpose. Do *not* do it because they have always been there. Always remember that this is for the first-time visitor or infrequent visitor.

The sign plan should also evaluate refuge access points, key visitor locations, angle of approach, scale of location relative to viewer, etc. This is an opportunity to identify the necessary messages and the most effective method setting signs for the location. Involve people (staff or volunteers) who are not typically involved with placing signs to get a variety of perspectives.

Identify Sign Locations with Sign Type:

This initial step is to identify where signs go and what type of sign is required at each location. To create a plan, start with a clean site plan drawing. Designate the area or management unit and mark the sign on the map. Assemble a plan in layers by sign type (off-site traffic/directional, on-site vehicle or pedestrian guide signs, fee signs/regulations, standard informational signs, building identification, etc.) and then mark each decision point or location where you want a visitor to get information. Identify the information type by referencing the sign type code given earlier in this document.

Individual Sign Planning Worksheets:

Once you have plotted a conceptual plan on the sign plan map, prepare an individual sign planning worksheet for each proposed sign location, and note at the top of the page unit/map grid/GPS code, the sign type, consecutive number, and site abbreviation for each proposed location on both this sign planning worksheet and the site plan/map drawing.

Wherever possible, we recommend you use standard sign types, but with specific text or information customized for your needs. Your Regional Sign Coordinator can assist with text and layout.

Sign planning worksheets should have the coded number for each proposed sign installation. Fill in the details for each sign type or assembly (based on sign type standard and the support structure chosen). We recommend that you complete the plan by sign type to maintain continuity in the flow to aid in message

recognition. If the sign content is unique to a specific location, attempt to follow the guidelines and look of the sign type required.

Sign Planning Worksheet/Field verification: Once the worksheet is complete, verify it in the field. When you conduct this review, you can adjust sign locations and note distances from key landmarks. You can also validate sizes and mounting heights. We recommend that you use paper mockups or, at a minimum, cardboard panels that are the same size and mounted in the same position as standard panels you plan to use.

I. Preparing Sign Artwork/Layouts:

Artwork for signs is prepared in layout programs or in vector art programs that are not generally used by field stations. It is more efficient for you to send your planning information sheets to your Regional Sign Coordinator, and he/she/they will have the artwork prepared centrally for the Region. Once prepared, the Coordinator will send proofs to you in PDF format for review. The digital artwork would be filed with the Regional Sign Coordinator or in another central location by field station and individual sign number. The information should include the date a sign was produced.

Sign Recording/Data Spread Sheet:

A computer Sign Record Spreadsheet may be prepared at the field site using a spreadsheet program to summarize and track signs by their code numbers. It is a way to share data between staff and hand off management from one person to another over time.

Based on the system, each sign has a series of attributes or components that used to describe the installation. This includes:

- The unique sign code and other pertinent data from the existing inventory/maintenance survey or new individual sign worksheet. Compile the final spreadsheet files for all signs after the entire sign planning process is complete for a site.

J. Funding Requirements and Implementation

Sign implementation is ideally based on a comprehensive plan. Budgets may require phased implementation over many years. Based on a sign plan, there are a variety of ways that programs can be implemented.

This section of the plan should include cost estimates for new or replacement signs to enable the entering of budget data into the SAMMS database.

Other implementation considerations include:

1. Complete replacement: If signs are dated and in poor repair, we recommend you replace all signs to create a consistent communications program. Because most sites are not heavily signed, this may not be as expensive as assumed, and the number of signs may be reduced with effective planning.
2. Incremental replacement: A phased approach to sign replacement means you may replace signs area-by-area or of a common type. The greatest impact is to replace all signs in a particular area at one time.
3. Attrition: When a sign is damaged, the information is no longer up-to-date, or if the sign is not functioning because it is in poor repair, it can be individually replaced based on your comprehensive plan.

Sign Ordering:

A sketch of the message and sign size for the location needs to be sent to the Regional Sign Coordinator (or vendor depending on the method used in your region for sign ordering) to produce a draft layout for your approval. Concepts are sent to the vendor your Region uses and a cost can be obtained for your site. In most cases, payment will be the responsibility of the site with the chosen vendor to produce the sign(s).

Ordering signs manually will require submitting a copy of the sign plan worksheet with applicable sign type and legend to identify content for the person creating artwork (Regional Sign Coordinator or vendor).

Once a sign is installed, an inventory/maintenance survey form should be completed for the sign and the information entered into your spreadsheet.

Appendix 1

The following page has example Inventory and Worksheet Pages:

Sign Inventory/Maintenance Survey - Station: Today's Date: _____ Next Review Date: _____

Photo: _____

Plases for a proposed to record survey data about existing signs. Information about several signs on each (less paper) or

	Unit/Map Grid/ GPS-Sign Type Code-Sign #					Sign Size			Reflective <input type="checkbox"/> Yes <input type="checkbox"/> No		Letter Size	
	Action Required	Priority	Sign Material	Structure Material	Automobile or Pedestrian Sign	Road Type	Viewing Distance	Traffic Speed Limit	Meets MUTCD Requirements <small>(Setback, height, break-away posts, letter size)</small>	<input type="checkbox"/> Yes <input type="checkbox"/> No	MUTCD Traf. Sign Type #	Watercraft Sign
	Narrative comments about sign condition, supports, legend, or changes needed.											

	Unit/Map Grid/ GPS-Sign Type Code-Sign #					Sign Size			Reflective <input type="checkbox"/> Yes <input type="checkbox"/> No		Letter Size	
	Action Required	Priority	Sign Material	Structure Material	Automobile or Pedestrian Sign	Road Type	Viewing Distance	Traffic Speed Limit	Meets MUTCD Requirements <small>(Setback, height, break-away posts, letter size)</small>	<input type="checkbox"/> Yes <input type="checkbox"/> No	MUTCD Traf. Sign Type #	Watercraft Sign
	Narrative comments about sign condition, supports, legend, or changes needed.											

	Unit/Map Grid/ GPS-Sign Type Code-Sign #					Sign Size			Reflective <input type="checkbox"/> Yes <input type="checkbox"/> No		Letter Size	
	Action Required	Priority	Sign Material	Structure Material	Automobile or Pedestrian Sign	Road Type	Viewing Distance	Traffic Speed Limit	Meets MUTCD Requirements <small>(Setback, height, break-away posts, letter size)</small>	<input type="checkbox"/> Yes <input type="checkbox"/> No	MUTCD Traf. Sign Type #	Watercraft Sign
	Narrative comments about sign condition, supports, legend, or changes needed.											

	Unit/Map Grid/ GPS-Sign Type Code-Sign #					Sign Size			Reflective <input type="checkbox"/> Yes <input type="checkbox"/> No		Letter Size	
	Action Required	Priority	Sign Material	Structure Material	Automobile or Pedestrian Sign	Road Type	Viewing Distance	Traffic Speed Limit	Meets MUTCD Requirements <small>(Setback, height, break-away posts, letter size)</small>	<input type="checkbox"/> Yes <input type="checkbox"/> No	MUTCD Traf. Sign Type #	Watercraft Sign
	Narrative comments about sign condition, supports, legend, or changes needed.											

Appendix 8

Accessible Signs

The U.S. Fish and Wildlife Service views universal design as an aspirational goal for our programs and facilities – one which recognizes our broad diversity of users and aims to achieve inclusion of *all* our visitors. Providing visitors with clear information so they can easily determine where they can go and what they can do, and how to do so safely, is primary.

Legislation

More than 50 million Americans have disabilities, and it is the responsibility of the Fish and Wildlife Service to assure that they are able to participate and take advantage of the services and facilities we offer to the public. The [Architectural Barriers Act of 1968](#) required “any building or facility, built or renovated, or leased with Federal funds, will be built to be accessible to and usable by physically disabled persons.”

In 1993, the Secretary of U.S. Department of the Interior directed that the Service must follow the [Americans with Disabilities Act Accessibility Guidelines \(ADAAG\)\(Directive No. 93-07\)](#). These guidelines contain specific guidance for certain types of signs.

[Section 504 of the Rehabilitation Act of 1973](#) states:

“No otherwise qualified individual with a disability in the United States shall solely by reason of his disability, be excluded from the participation in, be denied benefits of, or be subjected to discrimination under any program or activity conducted by any Executive Agency.”

Section 504 requires that persons with disabilities must be offered an opportunity to participate that is equal to that offered others and that separate aids or services shall not be provided unless necessary. In other words, the Service shall not provide separate facilities, but rather provide facilities that can be used by all whenever possible. This includes signs.

To the extent possible, signs shall be designed and produced in formats that are accessible to both persons with disabilities and persons without disabilities. However, if a person who is blind, for example, is unable to read such a sign, then he/she/they must be provided with options that will communicate the sign’s message in an alternative format. In this way equal opportunity to participate is provided. Guidance in this case is found in the [Code of Federal Regulations \(43CFR17.550\[b\]\[1\] – Program accessibility, and §17.560\[a\]\[1\] – Communication\)](#) which states:

“In choosing among available methods for meeting the requirements of this section, the agency shall give priority to those methods that offer programs and activities... in the most integrated setting appropriate.

“The agency shall furnish appropriate auxiliary aids where necessary to afford... an equal opportunity to participate in, and enjoy the benefits of, a program or activity conducted by the agency.

“In determining what type of auxiliary aid is necessary, the agency shall give primary consideration to the requests of the [person with disabilities].”

Several alternative methods of providing accessibility for signs are listed in [43CFR17.550\[b\]\[1 & 2\]](#).

Types of Disabilities

In general, four types of disabilities are recognized – *visual, auditory, mobility* and *mental*. Within these categories, there are many different types and levels of impairment.

Total blindness is one form of visual disability, but other forms of visual impairments or “low vision” are more common. Likewise, auditory disabilities include total deafness as well as various levels of hearing abilities. Mobility impairment is often associated with wheelchairs, but many persons with disabilities use walkers, crutches, canes and other aids and some may use no aids. Mental impairments include a wide variety of disabilities which are generally grouped as developmental disabilities (e.g., mental retardation) and mental illness (e.g., biological brain disease).

Types of Accessible Signs

Most Service signs must be accessible as described in this handbook. *Interpretive, wayfinding, information, and regulatory signs and maps* are not included in the signage standards of [ADA Accessibility Guidelines](#). However, these types of signs must be accessible under the requirements of the [Architectural Barriers Act and the Rehabilitation Act](#). Service guidelines have been developed for these types of signs and are described below in “Guidelines for Accessible Signs.”

Traffic signs and other signs that are meant to be read from inside a vehicle (e.g., building signs, some interpretive signs, etc.) do not need to meet accessibility guidelines.

Although captions, labels, operating instructions and other signs associated with **exhibits** must be accessible, this handbook does not address the requirements for those types of signs. Accessibility of exhibit signs shall be assured by exhibit planners and integrated into the exhibit design. Refer to FWS Accessibility Guidelines for Exhibits.

Another category of signs is described in the [ADA Accessibility Guidelines](#). While not technically “accessible signs,” as such, specific signs are required at accessible facilities (e.g., accessible parking spaces). These requirements are outlined in the section “Signs Required for Accessible Facilities.”

Guidelines for Accessible Signs

Service guidelines for accessible signs address the following variables:

- Text format
- Text content
- Alternative formats
- Maps
- Illustrations
- Mounting
- Lighting

The **text format** is determined by font, size, case, contrast, finish, and background. Format is perhaps the most important variable in producing accessible signs. Text must be highly readable if it is to be accessible to persons with various forms of low vision. Fonts may be serif or sans serif, but stroke width must be fairly consistent. Most script and ornate, condensed, or narrow fonts are not acceptable. See below for examples of acceptable and non-acceptable fonts. Italic fonts should be used sparingly (e.g., for Latin names, water bodies on maps, etc.). An exception is made for headers on interpretive signs which may be any type face. Text body on interpretive signs is not excepted.

Script <i>Format is the most important variable in producing accessible signs. Text must be highly readable if it is to be accessible to persons with low vision.</i>	Sans Serif Format is the most important variable in producing accessible signs. Text must be highly readable if it is to be accessible to persons with low vision.	Serif Format is the most important variable in producing accessible signs. Text must be highly readable if it is to be accessible to persons with low vision.
Not Accessible	Accessible	Accessible

The above fonts are too ornate or irregular. Not Accessible.

Vertical and horizontal stroke widths must be nearly equal. If not, an "H" may appear to be "II" to someone with low vision as illustrated in the center.

THIS TEXT IS ALL CAPITAL LETTERS.
The letters of this font are too narrow.
This text is script.
 Not Accessible

Accessible type size is dependent on the distance to which the sign can be approached; the closer one can approach the sign, the smaller the lettering can be. Type size is determined by measuring the height of a capital "X". Size requirements are as follows:

Minimum Possible Viewing Distance	Minimum Type Size (X-height)
0 to 1 ft	1/4 inch
1 ft to <4 ft	1/2 inch
4 ft to <6 ft	5/8 inch
6 ft to <15 ft	2 inches
15 ft to <21 ft	3 inches

Add 1/8 inch for each additional foot above 21 feet. Note that signs meant to be read from vehicles are excepted.

Text body (i.e., not headers) must be in upper and lower case. Interpretive signs are not excepted. Headers or short text (e.g., regulatory signs) may be all upper case. It is recommended for better readability that text of more than three lines should be flush left (i.e., not centered) with a ragged right margin and without hyphenation at right margin. Headers may be centered.

This text is fully justified with hyphenation. It is not recommended.	Text must be highly readable if it is to be accessible. This text is center justified and more than three lines. It is not recommended.	This text is left justified, with ragged right margin, and without hyphenation. It is recommended.
Less Accessible	Less Accessible	More Accessible

The contrast and finish of signs must follow the standards set forth in [ADAAG §4.30 and §A4.30.5](#). In general, characters should contrast with their background by at least 70%. Light characters may be on a dark background or dark characters may be on a light background. The finish (surface) of interpretive signs must be eggshell, matte or other non-glare finish. Do not place signs under glass.

The background beneath all text must be fairly plain without bold or complex patterns or photographs. Type which is applied to glass in a door or window shall be used on etched (“frosted”) or translucent (not clear or transparent) glass or applied over an opaque background.



Glass-covered sign produces reflections and reduces contrast.



Text content can be written to be more accessible to persons with learning disabilities. Since mental disabilities take many forms, it is difficult to require a set of standards to make signs accessible. It is recommended that sign messages be short and to the point when possible. The use of technical terms (e.g., “raptors”, “prescribed burn”) and jargon is especially to be avoided unless the terms are defined. Illustrations are also helpful. In many cases of learning disabilities, it is best to offer the alternatives of audio files or personal presentation of the text message.

[Section 504 of the Rehabilitation Act](#) as well as the [Code of Federal Regulations \(43CFR17.550\[b\]\[1\]\)](#) require the availability of **alternative formats**. Even if a sign complies with the above standards, not everyone with visual disabilities can read the sign. The most common alternative formats are Braille, raised letter text, audio tapes/CDs, and personal interpretive guides.

Braille (or more accurately, Grade 2 Braille) is a format consisting of raised dots which can be read with fingers. Braille may be available on a sign or on a paper handout (useful for interpretive trails, for example). However, relatively few people with visual disabilities can read Braille. ADAAG suggests ([§A4.30.4](#)) that interpretive guides, audio files or other means may be more effective especially for longer text.

Raised letters can be very useful for short messages. In fact, raised letters are required by ADAAG for some signs (see the section “Signs Required at Accessible Facilities”). The size and relief of raised letters are specified in [ADAAG §A4.30.4](#). Characters must be all upper case with a simple sans serif type face. But reading raised letters for long text such as interpretive signs is impractical because raised letters cannot be read quickly. Again, ADAAG suggests that interpretive guides, audio files or other means may be more effective especially for longer text. Raised letters are recommended for signs of less than 30 characters.

Although audio devices and personal interpretive guides are not actually sign formats, they are the most useful alternative, especially for interpretive signs and exhibit halls and galleries. The technical aspects of providing these formats is beyond the scope of this Handbook. However, it can be said that the verbal message must go beyond simply being an audible reading of signs. The presentation must be done by someone who is knowledgeable about *audio description*. Audio description gives a description of the exhibit itself in addition to the interpretive message. For example, a sign along a trail may interpret eagle behavior. The audio description could tell a person with low vision what color the eagles are, how big they are, where they are, etc., as well as explaining eagle behavior.

Visitor centers with exhibit halls or interpretive trails must offer audio description as an alternative format. This can be with an audio device that can be checked out at the station or with staff as a personal guide. There must be a sign prominently displayed which informs visitors that this alternative is available.

Maps on signs must also be accessible to people with low vision. Text on maps must follow the guidelines above for text format and content. Maps are unique in that colors are used to give information. Since some people are color blind to some degree, map symbols must be used which do not depend on color to distinguish them. For example, if gravel roads are indicated by a green line and paved roads are indicated by a red line (line width being equal), these lines may be difficult or impossible to tell apart. An accessible map could use red and green lines, but gravel roads could be a dashed line or a thinner line to distinguish them from paved roads.

An alternative format for maps is the relief map or topographic scale model. It is highly recommended that each station with outdoor public use (especially trails) have at least one map that is accessible to visitors with low vision. A relief map may be mounted in the visitor contact station or on a kiosk. Portable relief maps also can be made available to check out to take into the field. Portable maps can be produced as a sheet of embossed plastic. These alternative maps allow those with visual disabilities to get oriented to the site and to decide on options in a more independent manner. Direct personal experience of a map will provide more information than a verbal description provided by someone else.

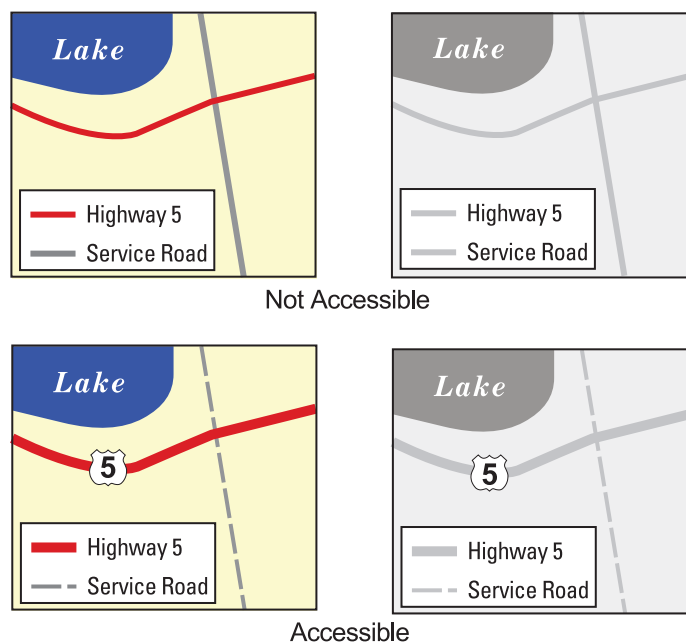

Illustrations are recommended for interpretive and exhibit signs which have text about a distant view or an object that would be difficult or impossible to see for persons with visual disabilities. For example, if a sign interprets a phenomenon in the distance, such as a concentration of waterfowl, then an illustration should be provided on the sign which would allow a person to move close and view the subject as a picture. Likewise, if an exhibit features a very small item, such as an insect, then that item should be shown in a larger-than-life illustration.

When **mounting** signs, they must be made accessible to people with mobility disabilities as well as visual disabilities. For waist-level signs along trails or at exhibits, the sign must be mounted so that a person in a wheelchair can approach and read the sign head-on (i.e., facing the sign). The lower front edge of the sign must be high enough (minimum 27 inches above the ground) with clearance to allow a person's knees to move under the sign. The height of the sign should allow comfortable reading by both seated and standing visitors.

Waist-level interpretive signs (27 or more inches high) along a trail must be positioned so that they do not overhang the trail by more than four inches. Objects which overhang more than four inches cannot be detected by a cane (if they are not in the detectable area) and present a hazard to those with low vision.

When possible, signs must be positioned such that people with visual disabilities can move to within three inches of the sign surface. Greater minimum distances require larger type.

For interior signs, the **lighting** must be sufficient or else the signs will not be accessible to those with low vision. Exterior signs must be sufficiently illuminated if the site will be used in the evening. Guidance is given in [ADAAG A4.30.8](#):

“Illumination levels on the sign surface shall be in the 100 to 300 lux range (10 to 30 foot candles) and shall be uniform over the sign surface. Signs shall be located such that the illumination level on the surface of the sign is not significantly exceeded by the ambient light or visible lighting source behind or in front of the sign.”

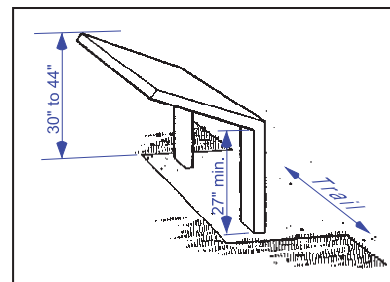

Interpretive Sign

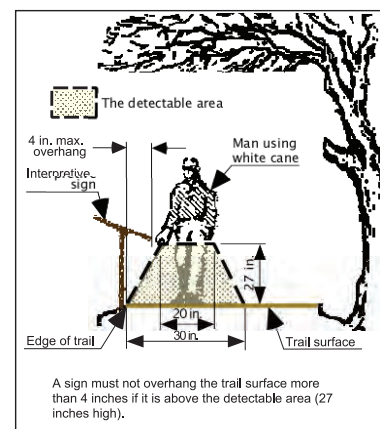

Signs Required at Accessible Facilities

The Americans with Disabilities Act Accessibility Guidelines and Service guidelines require signs at:

- Permanent rooms and spaces (accessible or not)
- Accessible parking spaces and passenger loading zones
- Some accessible entrances to buildings
- Some accessible toilet and bathing facilities
- Volume control telephones and text telephones (TDD)
- Assembly areas with assistive listening systems (ALS)

Note that the requirements in this section are not for *accessible signs*, as such. Accessible signs are discussed in “Types of Accessible Signs” and “Guidelines for Accessible Signs” below.

ADA Accessibility Guidelines include requirements for signs for **permanent rooms and spaces** and for signs which “provide direction to or information about *functional spaces* of the building.” (§4.1.2[7] and §4.1.3[16]) Building directories, menus and all other signs which are temporary are excepted.

At a minimum, Service facilities shall have signs at rest rooms and conference rooms which comply with [ADAAG §4.30](#). This section prescribes character proportion; character height; the use of raised letters, Braille, and Pictograms; finish and contrast; and mounting location and height. Signs should resemble below.

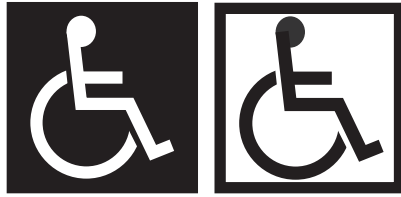

International Symbol of Accessibility



Raised letters with Braille below

Note that rest rooms must have an identification sign even if they are not accessible to wheelchairs and the International Symbol of Accessibility is not required. The International Symbol of Accessibility is shown above.

The ADA Accessibility Guidelines are specific in addressing signs and pavement markings at **accessible parking spaces and passenger loading zones** (§4.1.2[7][a & b], §4.6.3, §4.6.4 and §4.6.6). [ADAAG \(§4.6.4\)](#) specifies:

“Accessible parking spaces shall be designated as reserved by a sign showing the symbol of accessibility (see [4.30.7](#)). Spaces complying with [4.1.2\[5\]\[b\]](#) shall have an additional sign “Van-Accessible” mounted below the symbol of accessibility. Such signs shall be located so they cannot be obscured by a vehicle parked in the space.”

The “Van-accessible” requirement is shown right. Additional text is not required (e.g., “Reserved”). Sign colors are not specified except that the finish shall be “non-glare” and the “characters and symbols shall contrast with their background” (§4.30.5).



Vertical signage is always required at accessible parking spaces. The signs must include the International Symbol of Accessibility. If the space is van accessible, the sign must include the designation “van accessible”. The height of the sign must be 60 inches minimum above the ground, measured to the bottom of the lowest sign. (ADA 502.6)

Technical methods for measuring gloss and contrast are found in the appendix ([§A4.30.5](#)).

[Section A4.6.4](#) further states:

“Signs designating parking places for disabled people can be seen from a driver’s seat if the signs are mounted high enough above the ground and located at the front of a parking space.”

Additional signage in the form of pavement markings is required in [§4.6.3](#) and illustrated in ADAAG Figures 9 and A5. Note that ADAAG does not require the symbol of accessibility or blue paint to be applied to the parking space surface. (The parking lot surface is often obscured by snow or ice in some winter climates.) However, state or local laws may require such markings. The sign post shall not be installed in a position that blocks or constricts the width of the walkway such that it becomes impassable by persons using wheelchairs ([§4.3.3](#)).

In the case of parking spaces which are not paved and therefore cannot be painted, Service guidelines require that two signs be used to indicate the location and extent of the accessible parking space.

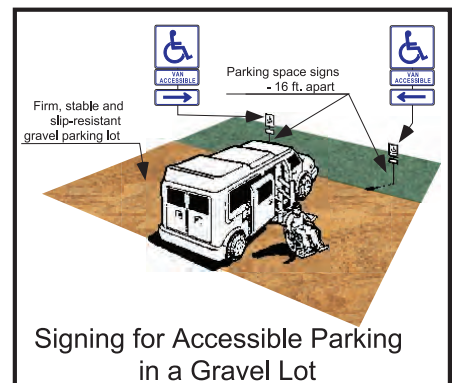

ADAAG also specifies the use of the International Symbol of Accessibility at “**accessible entrances** when not all [entrances] are accessible (inaccessible entrances shall have directional signage to indicate the route to the nearest accessible entrance)” (§4.1.2[7][c] and §4.1.3[8][d]). Likewise the Symbol shall be used at “**accessible toilet and bathing facilities** when not all are accessible” (§4.1.2-[7][d]). The International Symbol of Accessibility is shown in ADAAG in [Figure 43\[a\]](#) and [\[b\]](#).

Specific signs are required by ADAAG for **volume control telephones**, **text telephones (TDD)**, and in **assembly areas with assistive listening systems (ALS)** (§4.1.3[17][b], §4.1.2[19][b], and §4.30.7). Suggested text and illumination levels to accompany these symbols is found at [§A4.30.7](#) and [§4.30.8](#) in the appendix. The International TDD Symbol and the International Symbol of Access for Hearing Loss are shown at right and in ADAAG in [Figure 43 \[c\]](#) and [\[d\]](#).



Because **hiking and interpretive trails** vary considerably in difficulty for persons with disabilities, it is useful to indicate trail conditions at the trailhead. When conditions are known, people with disabilities can decide for themselves if they wish to proceed on the trail. The guidelines for Outdoor Developed Areas, including trails, can be found at www.access-board.gov/guidelines-and-standards/recreation-facilities/outdoor-developed-areas/final-guidelines-for-outdoor-developed-areas.

At a minimum, there must be a sign and/or map at the trailhead which indicates the length of the trail, the type of trail surface and its condition under various situations, maximum running slope (in percent), and typical cross slope (in percent). If any section of the trail is less than 36 inches wide, less than 80 inches high, or has water bars or stairs (i.e., impassable for a wheelchair), this must be noted at the trailhead. The trail surface must be described in terms of its surface material (e.g., compacted crushed rock, asphalt, boardwalk, etc.), and its condition and possible condition (rutted/eroded, over grown, gopher holes and mounds, soft mud, etc.) If a floating boardwalk is unstable when in use by one or more persons, this must be noted, also. If conditions are significantly different along different sections of the trail, then this can be indicated on a map. Give any other pertinent information that would require a person with a disability to turn around and return because of a barrier.

Optional trailhead information includes the accessibility level of associated facilities (e.g., observation deck and scope) and whether or not there are benches, shade and rest stops. A tactile map (i.e., relief map) at the trailhead is highly recommended for users with low vision.

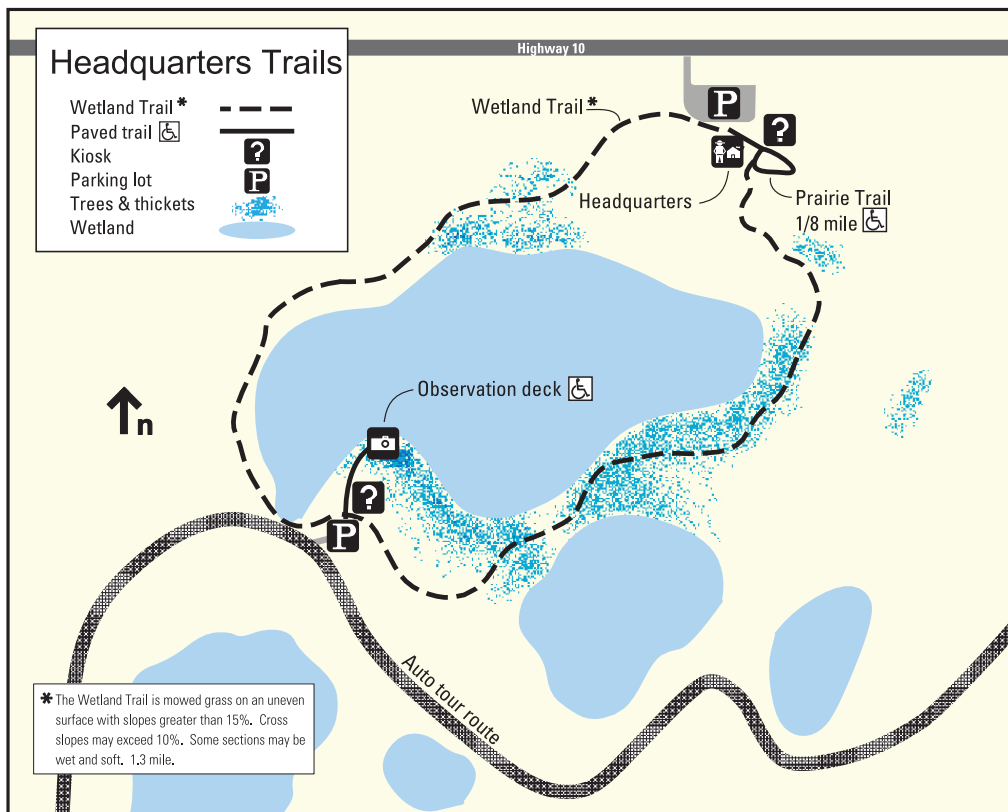

Map with trail information

References

United States Government publications:

- [Uniform Federal Accessibility Standards \(UFAS\)](#)
- [UFAS Retrofit Manual](#)
- [Americans with Disabilities Act Accessibility Guidelines \(ADAAG\)](#)
- [Smithsonian Guidelines for Accessible Exhibition Design](#)
- [The Arts and 504 – A Handbook for Accessible Arts Programming \(NEA\)](#)

United States Federal Legislation and policy:

- [The Architectural Barriers Act of 1968, Public Law 90-480](#)
- [The Rehabilitation Act of 1973 as amended, Title V, Public Law 93-112](#)
 - [Section 502 – Architectural and Transportation Barriers Compliance Board \(ATBCB\)](#)
 - [Section 504](#)
- [The Americans with Disabilities Act of 1990 \(ADA\)](#)
- [Public Lands: Interior Code of Federal Regulations \(CFR\), Vol. 43, Part 17](#)
- [Department of the Interior, Equal Opportunity Directive No. 93-07 – Disability Rights Accessibility Standards](#)
- [Outdoor Developed Area Guidelines](#)

Carol Hunter/Colorado Division of Wildlife:

- [Everyone’s Nature – Designing Interpretation to Include All](#)

U.S. Department of the Interior, National Park Service:

- [Programmatic Accessibility Guidelines for National Park Service Interpretive Media](#)

Current information on accessibility requirements can be found on the Access Board website:
www.access-board.gov

Appendix A

The following is from *Smithsonian Guidelines for Accessible Exhibition Design*. Originally a checklist for publications, it has been modified here for application to signs.

Design

- Leading is at least 20% greater than the font size used.
- Letter spacing leaves letters uncrowded.
- The main body of text is set in caps and lower case.
- There are a *maximum* of 60 characters (average) per line.
- The margins are flush left and ragged right unless right justification can be accomplished without greatly uneven spacing within the text line.
- Little or no hyphenation is used at ends of lines.
- The typeface used for main text is either a sans serif or a simple serif.
- No extreme extended or compressed typefaces are used for main text.
- Use oblique or italic typestyles only for foreign words and publications citations.
- Underlining does not connect with the letters being underscored.
- The color contrast of type to background – either dark on light or light on dark – is high (a 70% contrast is recommended).
- The color contrast of drawings or other illustrations to background is as high as the type contrast.
- Photographs meant to convey information have a wide range of gray scale variation.
- Line drawings and floor plans are clear and bold, with only necessary detail and minimum small type.
- Do not print type or illustrations over other designs, photographs, graphics, or text.
- The sign surface is matte.
- *Alternative formats* must be provided if *all* of the above criteria are not met. Prominently advertise the availability of the alternative formats is on site.

Content

- The text is written in clear, straightforward English.
- Pictorial information supports the text.
- Information on accommodations available to people with disabilities is integrated into other service information.

Appendix B – Alternative Formats

The following is from *The Arts and 504 – A Handbook for Accessible Arts Programming* by National Endowments for the Arts.

Communicating to Visually Impaired People

If you provide supplementary materials...make them available for people to use.... Mail out materials if possible, and be sure to advertise their availability.

Large Print

Many partially sighted people who cannot read regular print can read large print if it is clear, well-lighted, and has a contrasting background. The easiest way to produce something in large print is to type the material with a large font.

Typeset large print should be in a simple sans-serif face set at 14 to 18 points. Large print may be used for program materials as well as for exhibition labels and other displays. You may want to condense the content of very long materials when producing a large print version.

For recommendations and services regarding large print, write:

National Association for the Visually Handicapped
22 West 24th Street, 6th Floor New York, NY 10010
(212) 889-3141

Braille

Not all blind people read braille. If braille materials have been requested, the number of pages of material as well as the total number of copies will dictate which method of providing braille should be used.

Single copies can be produced by an experienced person using a brailler, a mechanical device similar to a typewriter. The brailler produces the embossed dots of the braille symbols. Multiple copies can be made by vacuum forming the pages or by braille presses. This work generally must be done by experienced braille printers. Local or state organizations for visually impaired people will know who can make braille copies.

Note: *Volunteers Who Produce Books: Braille, Large Type, Tape* is a geographical directory of volunteer organizations available at no charge from:

Reference Section
National Library Service for the Blind and Physically Handicapped
The Library of Congress
Washington, DC 20542

Tactile Materials

Many graphics such as maps, diagrams, and charts, can be reproduced in a tactile (touchable) version. The techniques used for duplication braille can be used to produce other tactile materials. Vacuum forming and thermoforming mold a thin plastic sheet using heat and a three-dimensional form or model.

Small scale models of buildings, exhibit layouts, or stage sets, for example, can help orient a visually impaired person. Models can also be used to reproduce art objects and exhibit pieces that are too large, too delicate, or too valuable to be handled directly.

Audio Files

Recording program materials on audio files is a good way to provide program handouts to visually impaired participants. Since many visually impaired people cannot read braille or large print, audio files may be the most usable provision.

Readers

If materials that a visually impaired person can use are not available, there is one last option: to provide that person with a reader. This is a stop-gap measure, but will work if there is not a large volume of material to be read.

Radio Reading Services

Radio reading is another form of communication accessible to blind people. Channels for radio reading and information services are distributed across the country. Descriptions of current exhibitions and performances as well as lectures and readings can reach a large audience through broadcasting. (Note: Short – range radio broadcasts can be used for interpretation on auto tour routes.)

Sound Systems

Blind and visually impaired people are almost totally dependent upon sound as a communications medium, so it is very important to have the best quality sound system possible. Often built-in systems are of low or average quality. The better the quality of the sound, the better will be the level of comprehension.

Audio Description

Audio description represents a landmark in technology that makes art (and interpretation) more available to people with visual impairments. [Dr. Margaret Pfanstiehl and Cody Pfanstiehl](#), the creators of audio description, refer to it as “the art of talking pictorial.” Audio description recreates in words the colors, setting, costumes, physical characteristics and body language used in live theatrical productions. It is a free narration service that attempts to describe what sighted people take for granted – those theatrical images that visual impaired audiences formerly could only experience through the whispered aides from a companion who could see.

Describers undergo extensive training to attain proficiency in this skill. For example, qualitative judgments are avoided; listeners must be free to deduce from the commentary.

Communicating to Learning Impaired People

Simple Language

Presentations especially for people with learning disabilities should be short, direct, and clear. The language should be simple, and supplemented with pictures as much as possible. The setting should be free from visual distractions and noise.

Pictures

Pictures can often supplement or substitute for written material. Many ideas can be explained more clearly if accompanied by illustrations, and traditional signs can usually be replaced by pictographs. Many standard signs, like those for rest rooms, telephones, or first aid, should be presented as pictographs.

Flexibility

Materials for learning disabled may often be presented as an introductory talk, a short lecture, or a tour. In preparing to talk to a group, keep the following in mind:

- focus clearly on one topic;
- keep your remarks short and the number of topics few;
- appeal to as many senses as possible;
- try to provide objects that people can handle;
- respond to interest or lack of it;
- make connections with already familiar ideas and objects.

Appendix 9

Bilingual Signs and Exhibits

This document is based on “*the bilingual dilemma*” and “*Taking the bilingual leap*” by Nancy Owen Renner.

The Service’s programs should be designed to offer quality visitor experiences for all segments of the public. Signs and exhibits are two effective ways to welcome and orient our visitors, but sharing important information in different languages can be challenging.

There is no universal procedure for developing signs or exhibits that use different languages. However, a good rule of thumb is to understand your audience’s needs and interests and start small. Bilingual interpretation does not always lead to increased public engagement, but it will help in sharing important messaging, stories, and other information to build appreciation and support for our conservation mission.

Not every non-English speaker may want, require, or demand bilingual interpretation. Observing and seeking feedback from your local community and visitors will provide useful insights on what types of signs and exhibits are needed. Also, remember that adding another language to your signs and exhibits is not just adding one more step; it doubles the amount of text and adds complexity about content, word choice, cultural relevance, design, and space constraints.

In developing signs and exhibits, it may be useful to examine how your visitor demographics compare with the community at-large; the role of tourism in attracting visitors; the use of bilingual interpretation to serve your current visitors and potential for attracting and welcoming new audiences; and how bilingual exhibits can enhance social interaction and learning.

As part of the sign and exhibit planning process, consider how bilingual text can be used effectively to convey information and messages, but be mindful that too much text can be overwhelming and not useful for our visitors.

Some Things to Consider When Planning Signs and Exhibits

Accessibility – Is equal access to information a priority on your field station? How easy or difficult is it to access second-language information for visitors with disabilities?

Customer Satisfaction and Comfort – Does the chosen media make second-language visitors feel like second-class citizens? Have you asked them?

Audience Interest – What media do your visitors prefer?

Social Interaction Potential – Will using a second language to share information enhance social interaction among visitors?

Audience Development Potential – Are there members of the community who can contribute to your efforts to share information in different languages?

Flexibility – How easy will it be to modify information on signs and exhibits?

Design Issues – Are you able to focus and limit content to accommodate a second language?

Think carefully about all the steps required to produce text in one language: research content, write, evaluate, edit text, and check for content accuracy. Avoid the literal translation.

Find a bilingual writer or translator who understands the subtleties of language and meaning used within your community. Request writing samples and seek feedback from trusted readers and community partners. Ensure a consistency of voice in the selected languages and recognize that idioms and regional dialects can present challenges. Employing these simple steps will help you share important information that welcomes visitors, promotes understanding, and enhances relevancy and cultural connections.

Tips for Writing Bilingual Text

Determine a word count based on readability, available space, and visitor research. Bilingual interpretation forces stricter limits on the amount of content in order to avoid the “wallpaper of words” effect. Keep cutting until the text is readable and fits the space. The second language may be longer than English due to differences in syntax.

Develop clear messages. The translated texts should be able to stand alone as if there were no English text blocks present, working within the graphic images and themes.

As in all interpretative and informational writing we encourage you to use:

- Clear information hierarchy: e.g. headline, subhead, and body;
- Short, concise text in digestible chunks;
- Simple sentence structure;
- Active voice;
- Logical progression of ideas;
- Links to objects and illustrations;
- Carefully worded questions.

Design Bilingual Media

A primary challenge is to devise a plan to differentiate the two languages. Establish a pattern and remain consistent. You may choose to treat the two languages equally or make one dominant, present the text integrated on one panel or separated on two. Spatial relationships between images, objects, and bilingual text may shape your plan. Test your design with a diversity of users and modify as necessary.

Some effective strategies include:

- Use consistent placement, e.g., English always on the left.
- Use two distinctly different type treatments for the two languages, e.g., two different type styles, two different type colors, or two different type sizes.
- Proofread the second language as carefully as the first. The work should be spell-checked and grammar checked in the second language.
- Accented vowels must be correctly accented. Importing text files with accents (`), tildes (~), and umlauts (¨) are widely available.

Planning and Managing the Project

Important questions to consider in planning the project include: what will it cost and what is the time commitment? These questions are best answered by your team members to address your project specifics. Some translators charge by the word. Involving second-language community members in the planning and development will save time in revisions later and yield greater dividends in relevance to the audience.

Building your Bilingual Infrastructure

In addition to completing a project, you are building the infrastructure for delivering future projects. Reaching out to the community, connecting with advisors, and providing language classes for staff are avenues to support your field station’s overall program. Building a broader support program will contribute to greater accessibility of content; be more welcoming to visitors who rely on a “second language;” enhance sensitivity to cultural diversity; create opportunities for learning a second language; and improve learning among social groups with varying language abilities.

Appendix 10

Interpretive Signs

The Service manual defines interpretation as, “a communication process that forges emotional and intellectual connections between the audience and the resource.”

Interpretation tells a story and brings meaning and interest to a subject.

The guiding principles of the Service’s interpretive program are:

- a. Promote visitor understanding of, and increase appreciation for, America’s natural and cultural resources and conservation history by providing safe, informative, enjoyable, and accessible interpretive opportunities, products, and facilities;
- b. Develop a sense of stewardship leading to actions and attitudes that reflect interest and respect for wildlife resources, cultural resources, and the environment;
- c. Provide quality interpretive experiences that help people understand and appreciate the facility and its role in refuge or hatchery system.
- d. Provide opportunities for quality recreational and interpretive experiences consistent with criteria describing quality found in 605 FW 1.6;
- e. Assist refuge staff, volunteers, and community support groups in attaining knowledge, skills, and abilities in support of interpretation; and
- f. Minimize conflicts with visitors participating in other compatible wildlife-dependent recreational activities.

Interpretive signs may include:

- Exterior or interior exhibits
- Trail markers
- Orientation panels/kiosks/ waysides

Many different materials and mounts are available for interpretive signs.

If you are not familiar with creating interpretive signs, contact your regional visitor services staff early in the process. They can provide resources, training, and guidance.

General Signage Principles

A well-developed interpretive sign will:

- Encourage resource understanding, respect, awareness, and ethical behavior of the visitor. What do you want the visitor to know, feel, understand, value, and remember?
- Explain the natural or cultural significance of a site. What happened here? Why does it matter?
- Communicate across languages and cultures. How can you tell the story visually or using other senses? In what languages?

Interpretation rules of thumb:

- Focus on one idea per sign.
- Understand your visitors. What do they expect from the site? How much time and interest do they have?

- Avoid agency propaganda. Visitors are interested in natural and cultural resources. Weave management messages sensitively into the message if it is relevant to the site.
- Interpretation is site specific. The visitor should see the resource being interpreted.
- Evaluate the final content by applying a couple of questions: So what? Why should I want to know this information?

Writing the text:

- Organize text in a hierarchy of importance or information. The headers (title), subheads, and captions should tell the general story.
- Research your themes and topics and then write your text. Write a first draft. Have other staff and volunteers review for accuracy and readability.
- Write as if you are talking directly to people. Use [plain language](#) (“we” instead of “the Service”)
- Avoid unfamiliar terms, acronyms, or bureaucratic jargon (i.e. riparian, FWS, NWR, moist soil management).
- Use active voice (e.g., “biologists found the plant” instead of “the plant was found by biologists”).
- Aim for a 5th to 7th grade reading level. Use online readability calculators.
- Be concise.

Interpretive signs should follow the [Smithsonian Guidelines for Accessible Exhibition Design](#).

Interpretive signs are never intended for viewing from a moving vehicle, so they are not subject to *MUTCD* standards of design or placement. Do not place signs where they would be distracting or hazardous for motorists.

If interpretive signs are located at pullouts or other areas within 30 feet of a roadway, they must meet *MUTCD* guidelines for breakaway supports (unless protected by a guardrail or topographic change).

Ordering

Field stations may not make interpretive signs. Consult your regional visitor services staff for assistance on interpretive sign planning, design, and ordering.



Appendix 11

Small Sign Pocket Guide

This document is provided directly from Georgia's Local Technical Assistance Program as a reference.

Small Sign Installation Pocket Guide

Conventional Signs - This guide has been developed for conventional size signs only. Largest conventional sign is a 36"x48" speed limit sign (12 sq ft). Larger signs will require dual posts or stronger posts.

There are two factors needed for selecting the proper sign post type. They are:

1. Area of sign (Sq. Ft.)
2. Length of post (Ft.)

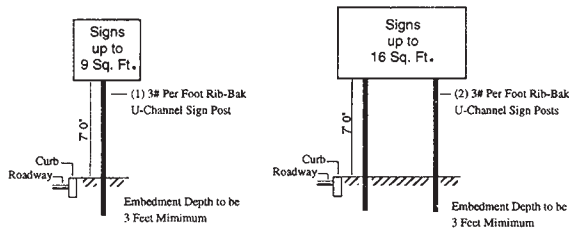

Area of Sign

The area of the sign can be found by multiplying the length (ft.) by the width (ft.). This calculation is simple for square and rectangular signs. Irregular shaped signs require using a chart or memorizing the area. Irregular shaped signs include stop, yield, no passing, railroad crossing and school signs.

Sign Area Table

Square or Rectangular Signs			
Sign Size	Area (Sq.Ft.)	Sign Size	Area (Sq. Ft)
8"x36"	2.0	24"x24"	4.0
8"x48"	2.5	24"x36"	6.0
12"x18"	1.5	24"x48"	8.0
12"x24"	2.0	30"x15"	3.0
12"x30"	2.5	30"x24"	5.0
12"x36"	3.0	30"x30"	6.5
12"x48"	4.0	30"x36"	7.5
18"x18"	2.5	30"x48"	10.0
18"x24"	3.0		
18"x36"	4.5	36"x36"	9.0
18"x48"	6.0	36"x48"	12.0
21"x15"	2.0		

Irregular Shape Signs	
Sign	Area (Sq. Ft)
YIELD (RI-2) 36"x36"	4.0
YIELD (RI-2) 48"x48"	7.0
YIELD (RI-2) 69"x60"	10.5
NO PASSING PENNANT(W14-3) 48"x36"	6.0
RAILROAD WARNING (W10-1) 36"Dia.	7.1
SCHOOL (SI-1) 36"x36"	7.0
School Crossing (S2-1) 36"x36"	7.0
STOP (RI-1) 30"x30"	5.5
STOP (RI-1) 36"x36"	7.5
STOP (RI-1) 48"x48"	13.5

Length of Post

The minimum length of post is the distance from the ground to the bottom of the sign added to the height of the sign and at least 3 more feet, the minimum distance installed into the ground.

Three (3) pound posts are easier and cheaper to install. Four (4) pound posts should not be used for most conventional sign installations. The 4 pound posts must be installed with breakaway footing which add to the cost and complexity of installing the heavier posts. Table 1 on the reverse side shows the cost effectiveness of dual 3.0 pound posts in comparison to 4.0 pound posts.



Georgia's Local Technical Assistance Program (800) 573-6445

2-Step Selection Guide

All posts should be driven or installed at least three (3) feet into the ground. Determining the proper post length is as simple as Two Steps:

- Step 1 \supset 36" signs or smaller (9.0 sq ft or less) - Use a 3# post and up to 13' total post length. (Check Table 1 for smaller size signs - example: sign faces of 4.5 sq ft or less can use a 18' length post.)
- Step 2 \supset 36", 48" or 60" signs (between 16 and 9 sq ft) - Use dual 3 # posts and up to 17' total post length. (Check Table 1 or smaller size signs - example: sign faces of 10.5 sq ft can use dual 20' length posts.)

Table 1
FHWA Wind Load Design for Rib-back Posts - Sign Area (Sq. Ft.)
Sign Post Length (Ground to Sign Bottom)

Post Size	6'	7'	8'	9'	10'	11'	12'	13'	14'
3.0 #/ft.	9.0	7.5	7.5	7.5	6.0	6.0	6.0	4.5	na
Dual 3.0 #/ft	25.5	24.0	22.5	21.0	19.5	18.0	13.5	12.0	10.5
4.0 #/ft.	12.0	10.5	10.5	10.5	9.0	9.0	7.5	6.0	6.0

(Source: Marion Steel Co., 80 ksi steel posts, 70 mph pressures. This table only applies to 80 ksi steel posts, other steel posts will need different length posts for the design sign area.)

If you have any problems with the Two Step Post Selection Guide ask your traffic engineer.

Examples of Post Length Selections Using the Three Step Selection Guide

Problem #1:

Install 36" stop sign on an urban road. The road is lower than the ground height and 3.5' from the edge of road. Choose the minimum length and weight of post.

Solution:

Sign Area: 36" stop sign has 7.5 sq ft of sign area. See Sign Area Table, Irregular Shaped Signs
Minimum length of post: 3' (foundation in ground) + 7' (urban area, ground to bottom of sign) + 0' (ground to road height) + 3' (36" sign height) = 13' post
Choose weight of post - Check step one, sign is less than 9 sq ft and is 13' in length.
Choose single 3# post - 13' length.

Problem #2

Sign Area: 24" x 36" speed limit sign on a rural road. The road is 5 feet higher than the ground level and 12' from the edge of the road. Choose minimum length and weight of post.

Solution:

Sign Area: 24"x36" sign is 2' by 3' and has a sign area of 6 sq ft. See Sign Area Table, regular shaped signs.
Minimum length post: 3' (foundation in ground) + 5' (rural area, ground to bottom of sign) + 5' (ground to road height + 3' (36" sign height) = 16' post length.
Choose weight of post - Check step one, sign is less than 9.0 sq ft and length is more than 13 feet; go to Table 1, sign is 6.0 sq ft, Table 1 allows a 6.0 sq foot sign face for a 12' length post from ground to sign bottom, add 3' for foundation and 3' from sign bottom to the top of sign (total allowed post length of 18').
Choose dual 3# post - 16' length.

Sign Size	"X" Dimension	"Y" Dimension
24"x24"	22"	10"
30"x30"	28"	13"
36"x36"	34"	16"
48"x48"	40"	16"
36"x36"	28"	8"
48"x48"	34"	9"
60"x60"	46"	15"
48"x36"	27"	10"
18"x18"	22"	10"
30"x30"	36"	16"
36"x36"	44"	19"
48"x 48"	49"	16"
60"x60"	62"	19"

**U.S. Fish & Wildlife Service
National Wildlife Refuge System
Division of Visitor Services and Communications
5275 Leesburg Pike
Falls Church, VA 22041-3803**

www.fws.gov

March 2019

