

**INTERPRETING AMMUNITION MARKINGS
AND COLOR CODES**

SUBCOURSE MM2597

Edition 6

**United States Army Combined Arms Support Command
Fort Lee, Virginia 23801-1809**

2 Credit Hours

CONTENTS

INTRODUCTION

AMMUNITION MARKINGS AND COLOR CODES (Tasks 093-400-1100 through 093-400-1109), 1

Interpreting Ammunition Markings, 1

Stock Numbers, 1. Department of Defense Identification Code, 2. Department of Defense Ammunition Code, 2. Nomenclature, 2. Supplementary Information, 2. Abbreviations, 3. US Army Model Numbers, 3. Model Numbers of Other US Services, 3. Additional Data, 3. Lot Number, 5. Markings on Ammunition Items, 5.

Interpreting Ammunition Color Codes, 6

Color by Primary Use, 7. Bands, 8. Combining Color Codes, 8. Standard Color Codes, 9. Exceptions, 9. Special Color Codes, 9. Special Symbols, 12.

REVIEW EXERCISES, 14

EXERCISE SOLUTIONS, 22

INTRODUCTION

It is essential that an ammunition specialist be able to identify ammunition. Before you can do this, however, you must learn how to interpret ammunition markings and color codes.

You may not be aware of it, but you have already been exposed to the use of marking and color code systems to identify items. There are the markings on products in stores, for example. The label on a container tells you what is in a container, the amount, and who made, it. Traffic lights, fire engines, and police cars are examples of color coding. Ammunition markings and color coding work in much the same way. You will know a great deal about an ammunition item if you understand the marking and color code systems.

Tasks. This subcourse, *Interpreting Ammunition Markings and Color Codes*, consists of one lesson based on the following tasks from soldier's manual STP 9-55B12-SM:

093-400-1100, Identify Fuzes.
093-400-1101, Identify Artillery Ammunition.
093-400-1102, Identify Mortar Ammunition.
093-400-1103, Identify Small Arms Ammunition.
093-400-1104, Identify Grenades.
093-400-1105, Identify Mines.
093-400-1106, Identify Small Guided Missiles.
093-400-1107, Identify Demolition Material.
093-400-1108, Identify Pyrotechnics.
093-400-1109, Identify Rockets.

Objectives. When you have completed this subcourse, you should be able to interpret ammunition stock numbers, nomenclatures, and other data markings applicable to ammunition items and packing containers, and to interpret color codes used on ammunition designating primary use, fillers, and hazardous materials.

Conditions. You will have this subcourse book and work without supervision. There are no supplementary requirements in material or personnel for this subcourse.

Standard. You must score at least 70 on the end-of-subcourse examination.

Credit Hours. Two credit hours will be awarded for the successful completion of this subcourse.

Passing score for ACCP material is 70%.

AMMUNITION MARKINGS AND COLOR CODES

INTERPRETING AMMUNITION MARKINGS

Stock Numbers

All items of issue in the Army are assigned a stock number. Two types of stock numbers are now in use, the Federal Stock Number (FSN) and the National Stock Number (NSN). The Federal Stock Number system is being phased out and replaced by the new National Stock Number system. However, older manufactured items will still have the FSN until they are renovated, modified, or used up.

Federal Stock Number. The FSN consists of 11 digits in three groups. It is explained in the chart that follows.

BREAKDOWN CHART	
DEFINITION	NUMBER
FEDERAL SUPPLY GROUP (FSG) All ammunition items are in the 1300 FSG series.	13
FEDERAL SUPPLY CLASSIFICATION (FSC) The two additional digits (30) mean that this ammunition is grenades.	30
FEDERAL ITEM IDENTIFICATION NUMBER (FIIN) The last seven digits of the FIIN tell the packing method and the type of filler.	-133-8244
FEDERAL STOCK NUMBER (FSN) This is a complete FSN.	1330-133-8244

National Stock Number. The NSN consists of 13 digits in four groups. Otherwise, the NSN has only minor differences from the FSN. The NSN is explained in the chart that follows.

BREAKDOWN CHART	
DEFINITION	NUMBER
FEDERAL SUPPLY GROUP (FSG) All ammunition items are in the 1300 FSG series.	13
FEDERAL SUPPLY CLASSIFICATION (FSC) The two additional digits (30) mean that this ammunition is grenades.	30
COUNTRY CODE (CC) These two additional digits designate the country that produced the item. The digits 00 and 01 are assigned to the U.S.	-00
NATIONAL ITEM IDENTIFICATION NUMBER (NIIN) The last nine digits of the NIIN are composed of the old FIIN and the country code.	-00-133-8244
NATIONAL STOCK NUMBER (NSN) This is a complete NSN.	1330-00-133-8244

Department of Defense Identification Code

Four additional digits are used with ammunition FSNs and NSNs. These four digits are called the Department of Defense Identification Code (DODIC). This code consists of a letter and three numbers. It is added to ammunition stock numbers to show interchangeability of the item. Take, for example, the following NSNs: 1315-00-028-4859 C445, 1315-00-028-4860 C445, and 1315-00-667-8034 C445. They all have different NIINs. Different NIINs may mean that ammunition items have different packings or fillers. However, since they all have the same DODIC, they have the same purpose and can be fired from the same weapon.

Department of Defense Ammunition Code

When the DODIC is used alone after the FSC, it is called the Department of Defense Ammunition Code (DODAC). An example is 1315-C445. All ammunition items with the same DODAC are interchangeable.

Nomenclature

The nomenclature, or name, of an item is marked immediately below the NSN on a container (see figure 1). The number preceding the nomenclature is the quantity of the item packed in the container. The nomenclature of the item packed in this box is Grenades, Hand, Fragmentation, and there are 30 of each in the box.

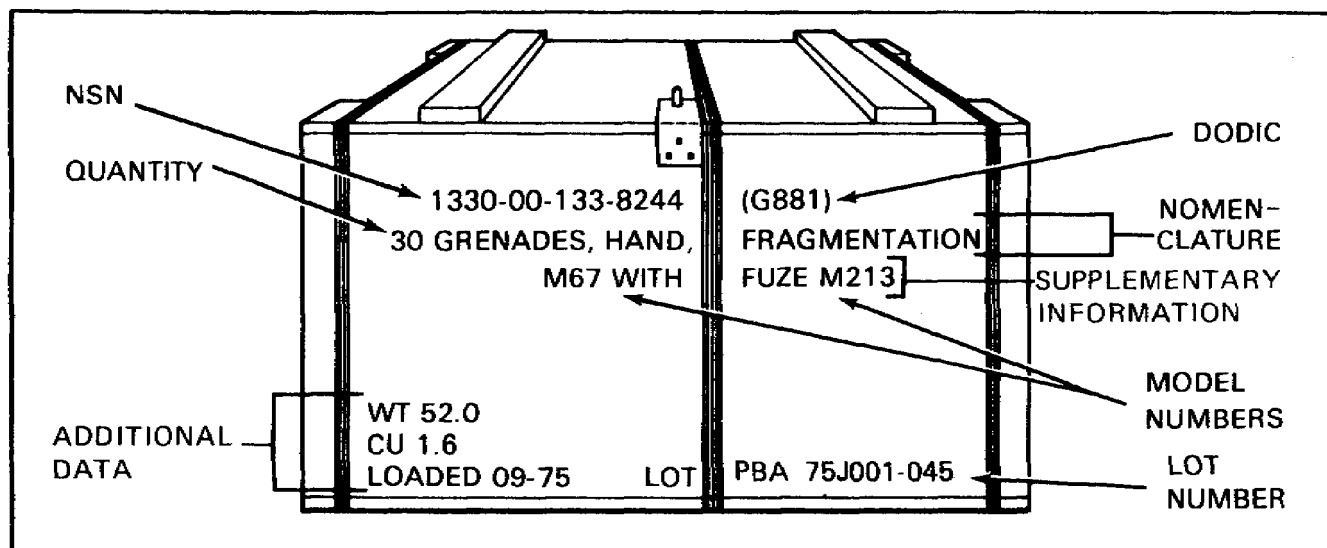

Figure 1. Typical Markings on Ammunition Box.

Supplementary Information

Immediately following the nomenclature, supplementary information is often added. In figure 1, the supplementary information tells the model number of the grenades and the model number of the fuze installed in the grenades.

Abbreviations

Nomenclature and supplementary information will often be abbreviated, using a standard system of abbreviation. The list on page 4 contains most of the abbreviations that are found in the nomenclatures and supplementary information on ammunition containers and ammunition items.

US Army Model Numbers

Model numbers are used to identify differences between items with the same nomenclature. All Army model numbers begin with the letter M. In M27, for example, M means, "standard model." Types of model numbers are explained as follows:

XM67. The X means that the item is developmental or experimental.

XM67E1. The E1 added means that the experimental item has one experimental modification.

XM67E2. The item has its second experimental modification.

M67. When the X is dropped, it means the item is no longer experimental or developmental and has become a standard item.

M67E1. Standard items may sometimes have experimental modifications. E1 means it is a standard item with one experimental modification.

M67A1. This model is a standard item with one approved modification.

M67A1E1. This model has one approved modification and one experimental modification. When the experimental modification becomes standard, the new model number will be M67A2, meaning it has two approved modifications.

Model Numbers of Other US Services

Some ammunition items used by the Army have Navy model numbers, which use the letters MK before the number. An item with the Navy model number of MK4 is referred to as "Mark 4." The letters AN preceding the model number designate the item as an Army-Navy item. An example is Grenade, Hand, Smoke, HC, AN-M8.

Additional Data

Now that you understand FSN, NSN, DODIC, DODAC, and model numbers, look at the ammunition box in figure 1 again. Note that there are other markings on the box that have not yet been discussed:

WT. The weight of the box in pounds, including all ammunition items and inner packing.

CU. The volume of the box in cubic feet using outside dimensions.

LOADED. The date (month and year) that the ammunition was assembled at the manufacturing plant.

ABBREVIATIONS COMMONLY USED IN AMMUNITION MARKINGS

ABBREVIATION/MEANING

A	in such as M21A1, modification of standardized items	IN	inch(es)
AN	in such as AN-M8, Army-Navy item	INC/INCND . . .	incendiary
AP	armor-piercing	INRT	inert
AP-T	armor-piercing with tracer	M	in such as M27, standard model
APDS-T	armor-piercing discarding sabot with tracer	MK	mark (to designate Navy model of item)
apers	antipersonnel	mm	millimeter
API	armor-piercing incendiary	MOD	modification
APIT	armor-piercing incendiary with tracer	MTL-LND	metal-lined
assy	assembly	MT	mechanical time
at	antitank	MTSQ	mechanical time, superquick
B	in such as M2A3B1, modification of a modified standardized item	NATO	North Atlantic Treaty Organization
BD	base detonating	NM	nonmetallic
BLK	blank	/	per
BX	box	PD	point detonating
cal	caliber	PDSQ	point detonating superquick
chg	charge	PERC	percussion
CNTNR	container	PETN	Pentaerythrite Tetranitrate
COMP B	composition B	PI	point initiating
COMP C	composition C	PIBD	point initiating base detonating
CRDBD	cardboard	PLYWD	plywood
CSTR	cannister	PRESS	pressure
ctg/CRTG	cartridge	PRMR	primer
CTN	carton	PROJ	projectile
DET	detonator	PT	point
E	in such as T53E4, modification of experimental or developmental item	PWP	plasticized white phosphorous
EA	each	PYRO	pyrotechnic
ELEC	electric	RD	round
FBR	fiber	RDX	cyclonite
FBRBD	fiberboard	SAP	semi-armor-piercing
FFAR	folding fin aircraft rocket	SD	self-destructing
GB	nerve gas	SEC	second(s)
HD	mustard gas	SQ	superquick
HE	high-explosive	STL	steel
HEAT	high-explosive, antitank	SUPPL	supplementary
HEAT-T	high-explosive, antitank with tracer	TNT	trinitrotoluene
HEI	high-explosive, incendiary	TP	target practice
HEI-T	high-explosive, incendiary with tracer	TP-T	target practice with tracer
HEP	high-explosive plasticized	TR	trace or tracer
HEP-T	high-explosive plasticized with tracer	TRCR	tracer
HES	high-explosive, spotting	TSQ	time and superquick
HVAP-T	hypervelocity armor-piercing with tracer	W or W/	with
HVTP-T	hypervelocity target practice with tracer	WO or W/O . . .	without
ILLUM	illuminating	WP	white phosphorous

Lot Number

The lot number is very important in accounting control and in malfunction investigations. The lot number of ammunition is on the lower right-hand corner of the box in figure 1. The lot numbering system, like the stock numbering system, is now being modified. The chart that follows contains an explanation and comparison of the old and new lot numbering systems.

COMPARISON OF OLD AND NEW LOT NUMBERING SYSTEMS		
	OLD PBA-1-45	NEW PBA75D001-045
MANUFACTURER'S SYMBOL (where manufactured)	PBA	PBA
YEAR AND MONTH OF PRODUCTION (when the ammunition was assembled)	Not used	75D
INTERFIX NUMBER (location and process of production)	-1	001
SEQUENCE NUMBER (sequence of production)	-45	-045

In the chart, PBA stands for Pine Bluff Arsenal, and 75D stands for the year 1975 and the month of April. (April is the fourth month; D is the fourth letter of the alphabet.) In the new system, the interfix number and sequence number are both always three digits (for computerizing purposes). The only major difference is that the old lot numbering system did not include the year and month that the ammunition was assembled by the manufacturer.

Month of Production. Each ammunition lot number commencing with the first lot produces, assembles, or modified will have the month of production inserted after the two (2) digit code identifying the year of production. The month of production is a single alpha code assigned as follows:

January - A	May - E	September - J
February - B	June - F	October - K
March - C	July - G	November - L
April - D	August - H	December - M

Markings on Ammunition Items

Once you can identify all the markings found on ammunition boxes, it is time to learn to identify markings found on ammunition items. See figure 2. Note the markings on the projectile.

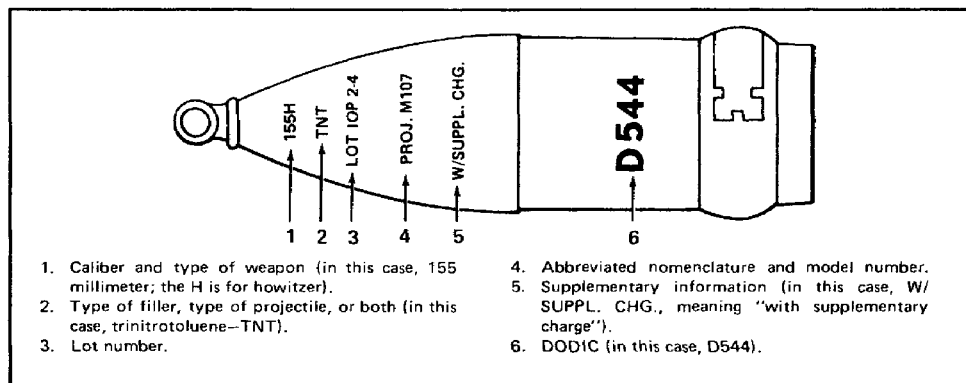

Figure 2. Typical Markings on 155mm HE Projectile.

Some small ammunition items may have differences in the location of markings, but all markings will include basically the same information.

See figure 3. These 105mm projectiles have the same markings as the 155mm projectile in figure 2, with some differences in location. The DODIC is not on smaller items because there is not enough space, but the entire NSN and DODIC is on the container for the ammunition. The 155mm projectiles have no containers.

INTERPRETING AMMUNITION COLOR CODES

Ammunition items can be further identified by the color of the paint used on them. It is essential that ammunition personnel know what each color indicates and how color codes are used. (The color codes in this lesson apply only to ammunition items larger than 20mm. Color codes for ammunition items 20mm and smaller are discussed in another subcourse.)

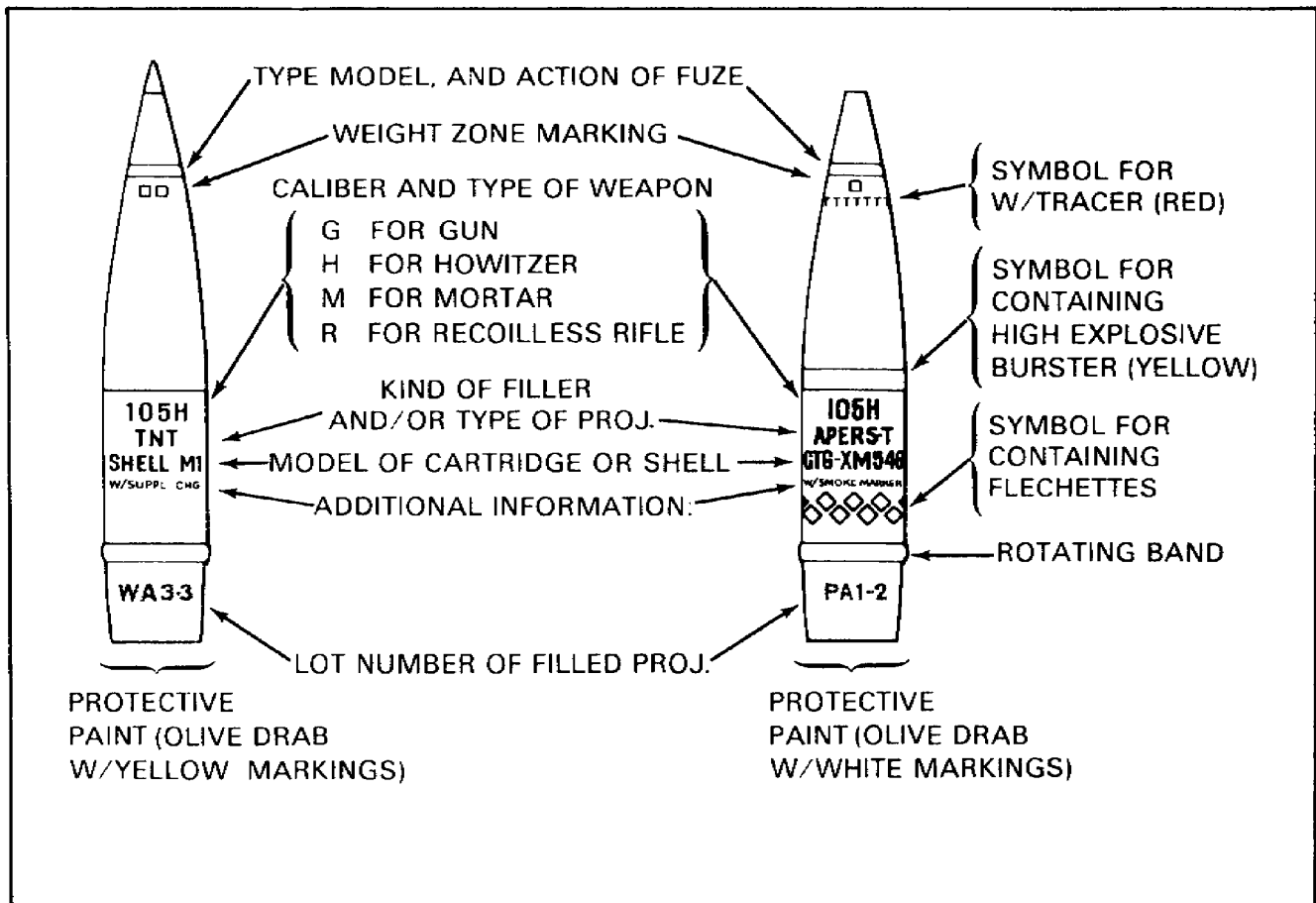

Figure 3. Artillery Ammunition Markings.

Color by Primary Use

Ammunition items are painted primarily to prevent rust. The colors used are for camouflage, to identify the primary use of the item, and to identify hazardous fillers used in the ammunition. These are the colors used to indicate primary use of ammunition items:

- **Yellow.** High-explosive.
- **Brown.** Low-explosive.
- **Gray.** Chemical.
- **Light-green.** Smoke.
- **Light-red.** Incendiary.
- **White.** Illuminating-pyrotechnic.
- **Black.** Armor-defeating.
- **Aluminum (silver).** Countermeasure.
- **Blue.** Practice.

The most commonly used color, olive drab, is not even listed, because it has no significance. Olive drab is used only for camouflage.

The primary use color may be on the markings or on a band around the item when it is not practical to use it as a base color. The high-explosive (HE) projectile in figure 4 is an example of the use of color on the markings. The base color is olive drab, which has no meaning; but the yellow markings clearly designate it a high-explosive projectile.

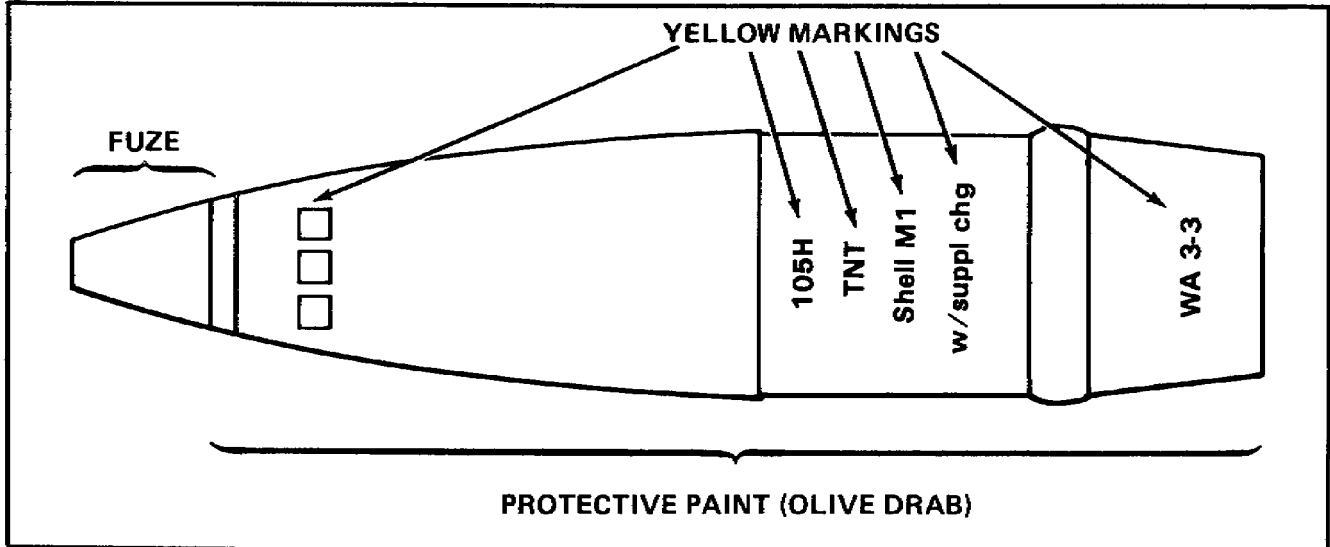

Figure 4. HE Projectile.

Bands

Bands are usually used to identify types of components used in the item. However, in some cases, the color of the band identifies the primary use. The colors used and their meanings are:

- **Yellow.** Contains a high-explosive burster. (HE bursters are used to rupture the case and disperse the smoke mixture, toxic chemical agent, or antipersonnel flechettes.)
- **Brown.** Contains a low-explosive charge. (Low-explosive charges are usually used for spotting or expelling the payload.)
- **Dark-green.** Contains a toxic chemical agent.
- **Dark-red.** Contains a riot-control chemical agent.
- **Violet.** Contains an incapacitating chemical agent.
- **White.** Indicates an illuminating munition.
- **Black.** On a high-explosive plastic (HEP) projectile, means armor-defeating.

Combining Color Codes

On some types of ammunition, several color codes may be used on the same round of ammunition to identify the primary use, type of components, and hazardous materials. See figure 5. Identify the color codes in the following order:

1. *Base color.* Light-green means the primary use is smoke.
2. *Band.* Yellow band means this item contains a high-explosive burster.
3. *Markings.* Light-red markings mean that this item also has incendiary effects.

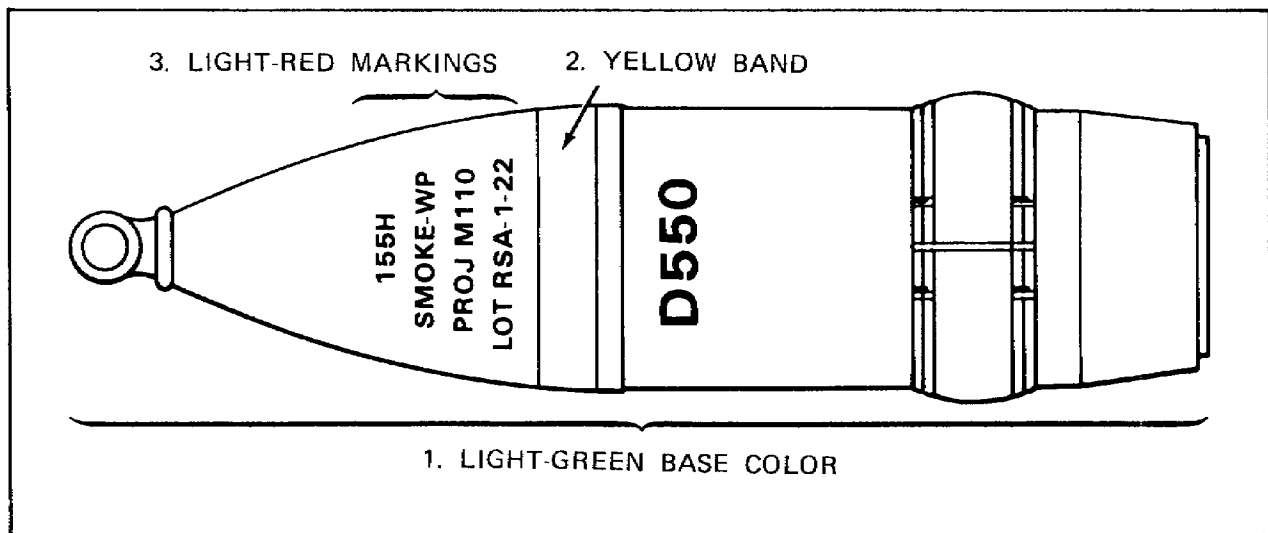

Figure 5. Separate Loading Projectile.

Now, if you combine your knowledge of color codes with what you learned about markings, you can identify this item completely. It is a 155mm howitzer smoke projectile with a white phosphorous (WP) filler and a high-explosive burster charge.

Standard Color Codes

Study figure 6 to learn how colors are applied to the various types of projectiles.

1. Read the type of projectile.
2. Read the colors used.
3. Compare these colors with the colors listed on pages 7 and 8.
4. Read the notes on each projectile.
5. Note how the primary use color code and the component color codes are used.

Exceptions

You probably noticed that some of the items in figure 6 had white markings but were not illuminating and some items had black markings but were not armor-defeating. This is because some colors have no significance as they are applied, including the following:

White. When used on guided missiles, mine dispensers, and rocket launchers.

Black or white. When used for lettering or special markings. [For example: white markings on nonexplosive armor-defeating, antipersonnel (apers), practice, or dummy munitions, and black markings on illuminating, smoke, incendiary, leaflet, and tracking munitions have no significance.]

Gray, black, green, or white. When used on underwater ammunition.

Unpainted. The natural color of ammunition items has no significance.

Special Color Codes

Some ammunition items have colors applied that do not comply with standard color coding. Examples include:

Smoke grenades. If a smoke grenade is to emit colored smoke while functioning, the color of the top of the grenade will be the same as that of the smoke—yellow, red, green, or violet.

Signals and flares (pyrotechnics). The color of the flare or star clusters is indicated on pyrotechnics by a band of C's in the same color.

Tracer ammunition. Some projectiles containing tracers have a series of T's above the markings of the projectile in the same color as the flame of the tracer.







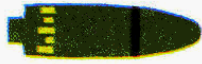

TYPE OF PROJECTILE	DESCRIPTION	
HIGH-EXPLOSIVE	Olive drab w/yellow markings	 HE  HEP (over 40mm) black band
ARMOR-DEFEATING	w/o HE: black w/white markings	 AP, APDS, HVAP
	w/HE: black w/yellow markings	 HEAT  AP w/HE filler
ANTIPERSONNEL	Canister: OD w/white markings	 w/slugs  w/flechettes white diamonds
	Cartridge, apers w/flechettes: OD w/white markings and diamonds, yellow band	
PRACTICE AND DUMMY	w/o explosive: white markings	 practice blue body  dummy bronze body
	w/explosive: blue w/white markings	 low-explosive brown band  high-explosive yellow band

Figure 6. Standard Color Coding.



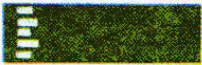
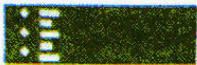

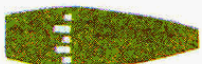

TYPE OF PROJECTILE	DESCRIPTION	
IMPROVED CONVENTIONAL MUNITIONS (ICM)	Olive drab w/yellow markings  yellow diamond	
TOXIC CHEMICAL AGENTS (casualty agents)	Gray w/green markings, yellow band if w/explosive burster  one green band	
IRRITANT AGENTS (riot-control agents)	Gray w/red markings, yellow band if w/explosive burster  one red band	
ILLUMINATING	White w/black markings, OD w/white markings and band for separate loading projectiles  	
SMOKE	Light-green body WP, PWP  light-red markings, yellow band	other smoke  black markings
INCENDIARY	Light-red w/black markings 	
COUNTERMEASURE (leaflet)	Aluminum w/black markings, brown band if w/low-explosive burster 	
TRACKING AND RECOVERY	Orange w/black markings 	

Figure 6. Standard Color Coding (continued).

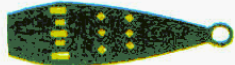
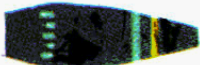
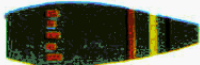
Special Symbols

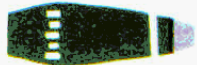
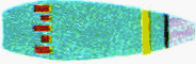
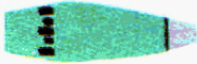
Special symbols (see figure 7) are used in conjunction with color codes to indicate some special features of an item. Examples include:

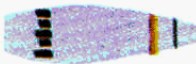
Diamond band. When a band of diamond-shaped symbols is painted around a projectile, the color of the diamonds designates the type of payload. White diamonds mean that the item is filled with flechettes or small metal spikes. The band of white diamonds may be accompanied by a yellow band indicating that a high-explosive charge is used to scatter the flechettes or spikes. Yellow diamonds mean that the item is filled with smaller items of explosive submunitions to be expelled from the projectile during flight. These items are often known as improved conventional munitions (ICM).

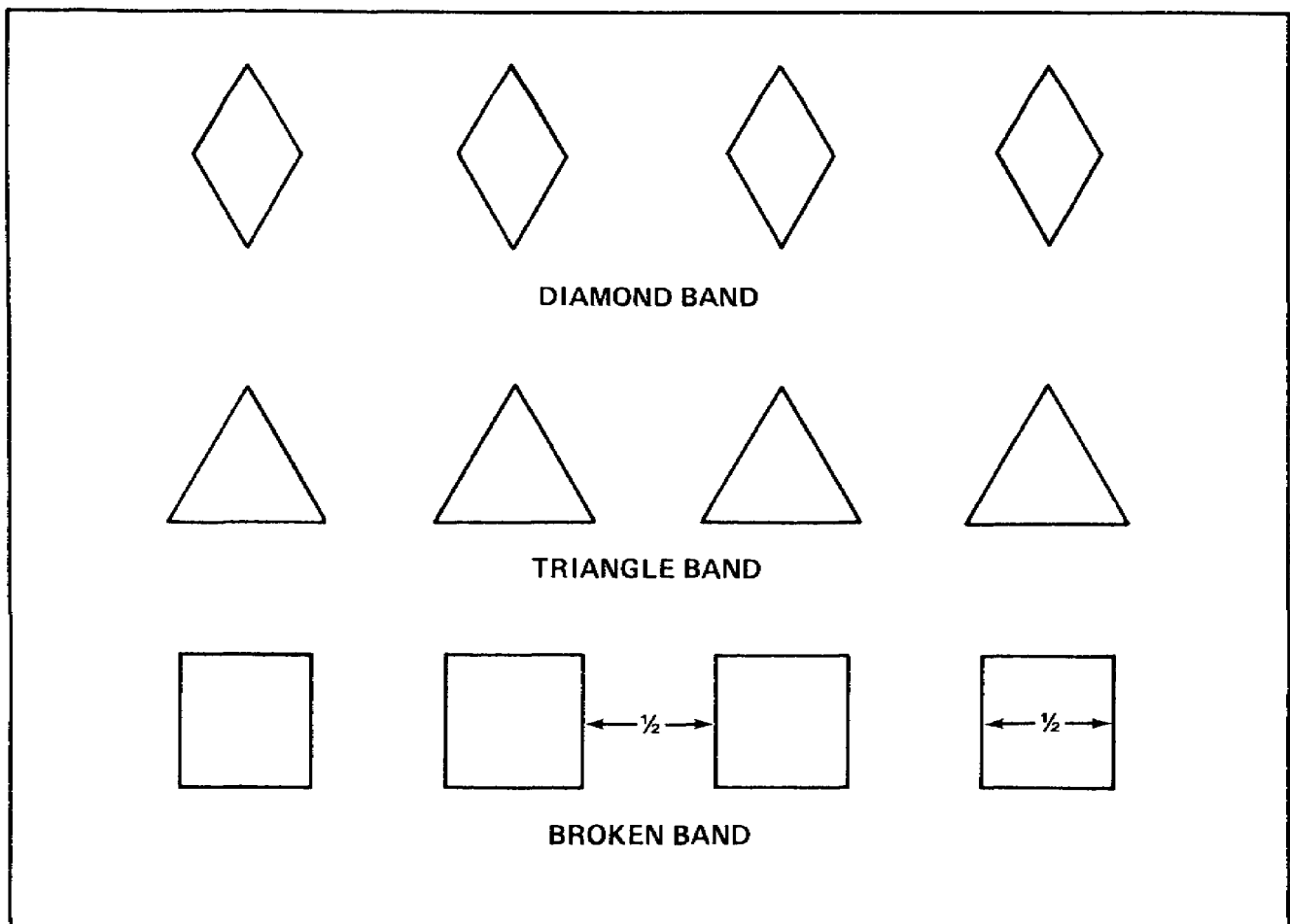

Figure 7. Special Symbols.

Triangle band. Yellow triangles forming a band around a projectile mean that it is filled with small explosive mines to be expelled and scattered during flight.

Broken band. Broken bands around the circumference of a projectile indicate binary ammunition items. "Binary" means that the item contains two separate elements that remain inert until mixed. A yellow broken band indicates that the item contains explosive binary elements. A dark-green broken band indicates that the item contains toxic chemical binary elements. *Note:* These bands are not to be confused with the weight zone markings as shown in figures 3 and 4.

When you are sure that you understand how to interpret ammunition markings and ammunition color codes, do the Review Exercises.

REVIEW EXERCISES

Answer questions 1 through 10 using figure 8 and questions 11 through 15 using figure 9.

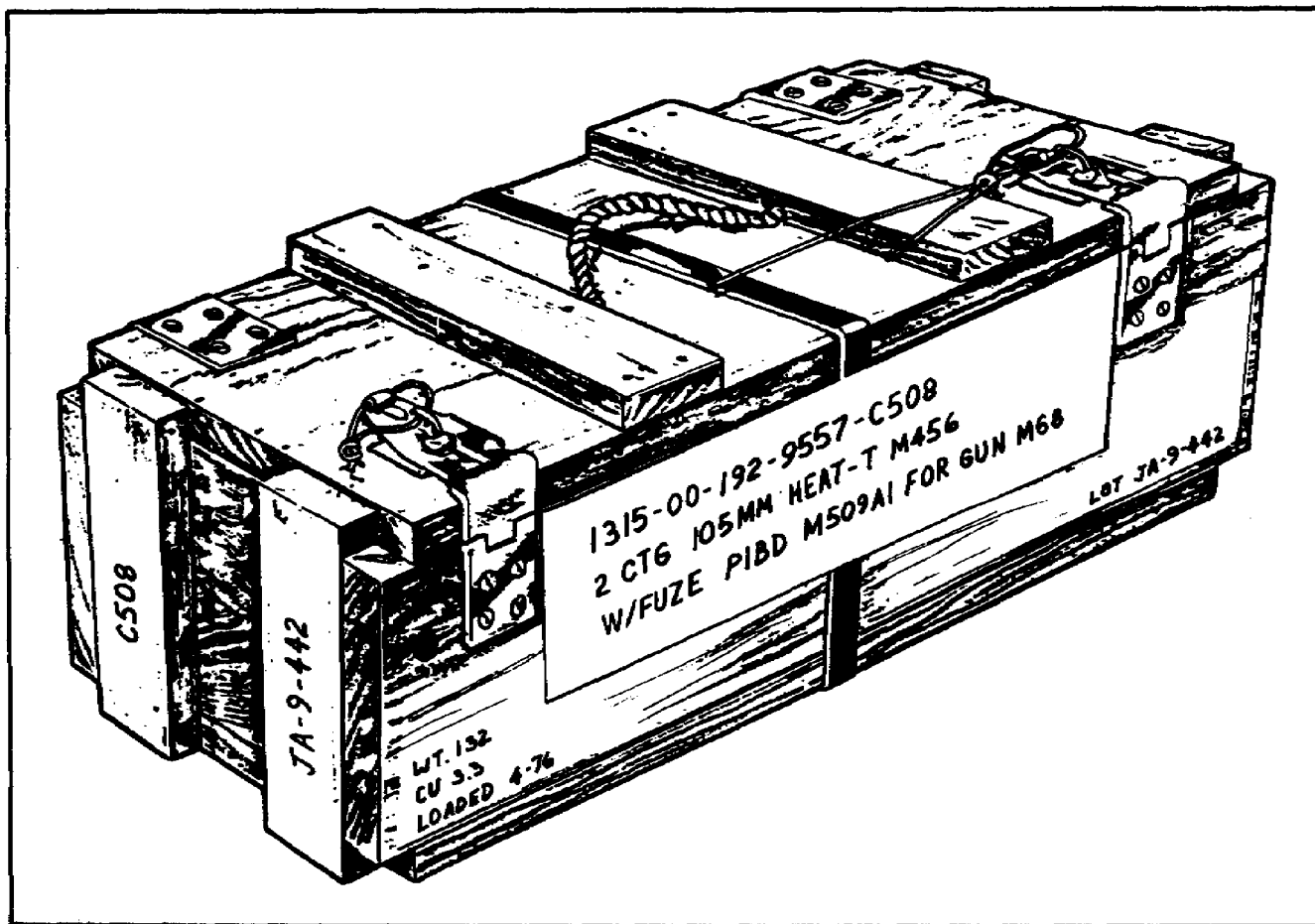

Figure 8. Typical Ammunition Box Markings.

1. What is the lot number of this ammunition?
2. What is the DODIC?
3. What type of ammunition is packed in this box?
4. How many rounds are in this box?

5. When were these rounds assembled?
6. What is the weight of this box?
7. What is the model number of this ammunition?
8. How many approved modifications have been made on the fuze installed in these rounds?

9. What is the NSN?
10. What is the country code?
11. What type of weapon is this item fired from?
12. What is the DODIC of this item?
13. What is the lot number of this item?
14. What type of filler is in this item?
15. What is the model number?

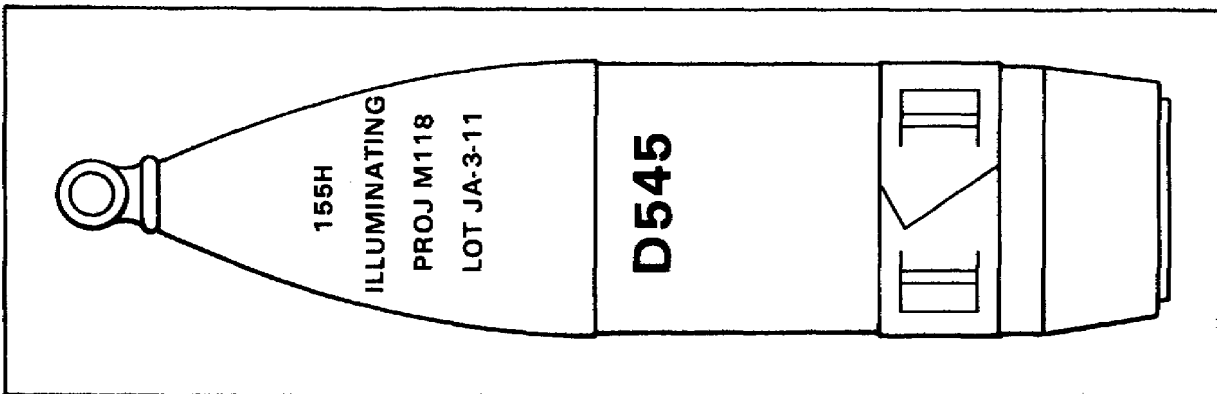

Figure 9. Separate Loading Projectile Markings.

16. Match the primary uses (right) to the colors (left) by writing the numbers in the blanks.

Colors

- ___ a. Light-red
- ___ b. Blue
- ___ c. White
- ___ d. Yellow
- ___ e. Aluminum (silver)
- ___ f. Gray
- ___ g. Brown
- ___ h. Light-green
- ___ i. Black

Primary Uses

- 1. High-explosive
- 2. Demolitions
- 3. Countermeasure (leaflet)
- 4. Low-explosive
- 5. Incendiary
- 6. Practice-training
- 7. Armor-defeating
- 8. Antiaircraft
- 9. Smoke
- 10. Illuminating
- 11. Chemical

17. What does the color olive drab indicate on an ammunition item?

18. What type of ammunition item is color coded gray with a dark-green band?

19. What does a band of white diamonds indicate?

20. What does the color white indicate on an underwater ammunition item?

Go back over the questions and recheck your answers. When you are satisfied that you have answered every question to the best of your ability, check your answers against the Exercise Solutions. If you missed five questions or more, you should retake the entire lesson, paying particular attention to the areas in which your answers were incorrect.

EXERCISE SOLUTIONS

1. JA-9-442 (see page 5 and figure 1)
2. C508 (see page 2 and figure 1)
3. 105mm high-explosive, antitank with tracer (see figure 1 and chart on page 4)
4. Two (see figure 1)
5. April 1976 (see figure 1 and page 3)
6. 132 pounds (see figure 1 and page 3)
7. M456 (see figure 1 and page 3)
8. One (see figure 1 and page 3)
9. 1315-00-192-9557 (see figure 1 and page 1)
10. 00 (see figure 1 and page 1)
11. Howitzer (see page 5)
12. D545 (see figure 2 and page 2)
13. JA-3-11 (see figure 2 and page 5)
14. Illuminating (see figure 2)
15. M118 (see figure 2)
16. a. 5, b. 6, c. 10, d. 1, e. 3, f. 11, g. 4, h. 9, i. 7 (see page 7)
17. No significance (see page 7)
18. Toxic chemical (see page 8 and figure 8)
19. Flechette filled (see page 12 and figure 7)
20. No significance (see page 9)