

U.S. Army Air Forces. Office of Flying Safety

RESTRICTED

AAF MANUAL 51-126-6

This revised edition supersedes the 2nd edition (brown cover) Pilot Training Manual for the Superfortress. All copies of this and other editions are rescinded.

B-29

Headquarters Army Air Forces
Washington, 15 December 1945

The use and authentication of this manual are governed
by the provisions of AAF Regulation 50-17.

BY COMMAND OF GENERAL ARNOLD



IRA C. EAKER
Lieutenant General, United States Army
Deputy Commander, Army Air Forces

OFFICIAL:
H. G. CULTON
Colonel, Air Corps
Air Adjutant General

Additional copies of this manual may be
obtained in accordance with the provisions of AAF Regulation 50-17

Initial distribution revised edition:

Headquarters AAF, Continental Air Force, and AAF Training Command.

RESTRICTED

PILOTS' AND FLIGHT ENGINEERS' TRAINING MANUAL FOR THE SUPERFORTRESS

Transportation
Library

TL
686
S96
1945

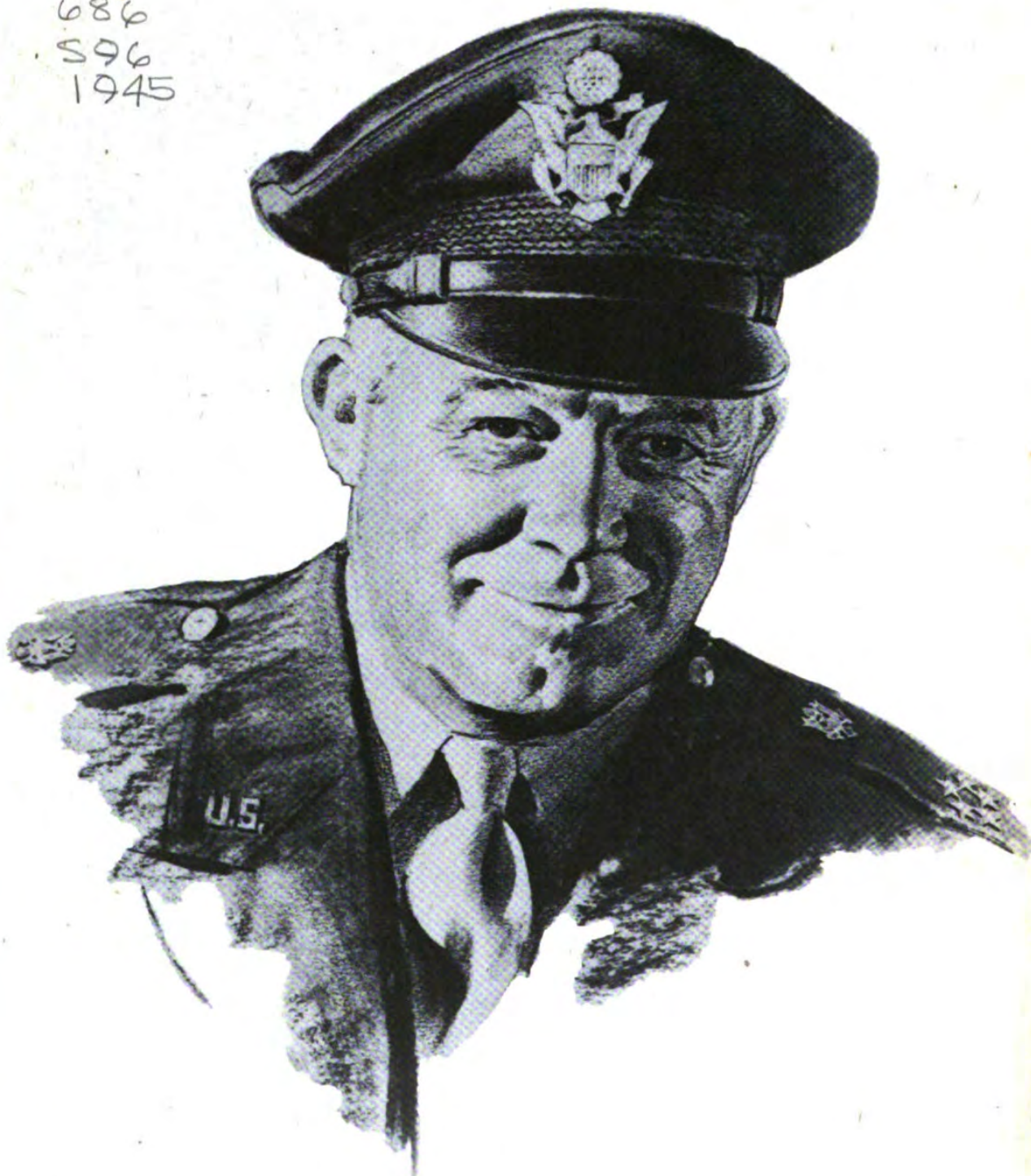



I N T R O D U C T I O N

This manual is the text for your training as a B-29 airplane commander or flight engineer.

The Air Forces' most experienced training and supervisory personnel have collaborated to make it a complete exposition of what your duties are, how each duty will be performed, and why it must be performed in the manner prescribed.

The techniques and procedures described in this book are standard and mandatory. In this respect the manual serves the dual purpose of a training checklist and a working handbook. Use it to make sure that you learn everything described herein. Use it to study and review the essential facts concerning everything taught. Such additional self-study and review will not only advance your training, but will alleviate the burden of your already overburdened instructors.

This training manual does not replace the Technical Orders for the airplane, which will always be your primary source of information concerning the B-29 so long as you fly it. This is essentially the textbook of the B-29. Used properly, it will enable you to utilize the pertinent Technical Orders to even greater advantage.



Commanding General, Army Air Forces

YOUR DUTIES AND RESPONSIBILITIES AS

Airplane Commander



The B-29 is a teamwork airplane, and you are the captain of that team. Your success in combat, and the safety of your crew and the airplane, depend on how well you organize your team and how well you lead it.

You are no longer just a pilot—you hold a command post and all the responsibilities that go with it. You are flying an 11-man weapon. It is your airplane and your crew, not only when you are flying, but for the full 24 hours of every day.

Your crew is made up of specialists, every one an expert in his line. Each one contributes an important part to the whole. Know their capabilities as well as their shortcomings. Know them as men as well as specialists. Know their background, their personalities, their individual problems, their needs for specific training.

You can't fly the B-29 alone. You need the full cooperation of your crew and you can get that cooperation only if the morale of your crew

is good. You can help build that morale by taking the trouble to know just a little more than usual about your crew members. Find out who they were, where they lived, and what they did before the war. It gives a man considerable lift to have his commanding officer say something casually now and then about the town where he lived, his family, or the work that he once did. Make a point of showing genuine interest in your men; it will pay big dividends in morale.

Make each crew member feel that he is an important part of the team. Make a point of letting each man take a short turn at the controls during practice missions while you or the copilot stand by on dual. Make a tour of all stations at least once during every practice flight. Talk to the men, ask them questions about their duties, try to clear up any questions they may have. Make them want to have the best team in their squadron.

RESTRICTED

5

RESTRICTED

As airplane commander, you are responsible for the daily welfare of your crew. See that they are properly quartered, clothed, and fed. See that they are paid when they should be paid. Away from your home station, carry your interest to the point of financing them yourself, if necessary. You are the commander of a combat force all your own—a small but specialized army—and morale is one of the biggest problems in any army, large or small.

DURING TRAINING

Train your crew as a team. Make teamwork their byword. Keep abreast of their training. It won't be possible for you to attend all courses of instruction with the members of your crew, but you should check their progress and their records constantly. Get to know each man's duties and help him to devise means for performing them quickly and efficiently. If knowledge is lacking on some specific point, supply it.

Pair off your crew members and have them check and train each other. Simulate combat conditions and emergency situations and have each crew member describe his duties. Ask them what they would do under the following and similar conditions:

1. A designated crew member is seriously wounded.
2. A designated turret is out of commission.
3. Gasoline or oil is leaking from a designated part of the airplane.
4. The airplane must be abandoned.
5. Bombs fail to drop.
6. Bomb bay doors fail to open.
7. Landing gear fails to operate.
8. You are forced to land in enemy territory.
9. You are forced to land on water.
10. Fire occurs in some part of the airplane.

A B-29 crew consists of airplane commander, copilot, flight engineer, bombardier, navigator, radar observer, radio operator, central fire control specialist gunner, left gunner, right gunner, and tail gunner.

As airplane commander you must:

1. Know your airplane and how it operates.
2. Be able to take off and land under adverse conditions.

3. Be able to fly under instrument conditions either with or without radio aids.

4. Be able to use blind-landing systems.

5. Be able to navigate and locate your position with the various radio and radar aids available.

6. Be proficient at formation flying, including the proper performance of evasive tactics at various speeds and altitudes.

7. Be able to get the most out of your airplane under all conditions.

8. Know your crew.

9. Know yourself.

COPILOT

Your copilot is your assistant—the executive officer of your command post. He must be able to do everything that you can do so that he can assume full command should the occasion arise. You and he should be virtually interchangeable. Let him handle the controls at least 30% of the time. **Remember that your copilot is a potential airplane commander.**

NAVIGATOR

Your navigator must:

1. Be proficient in pilotage, dead reckoning, radio, and celestial navigation.

2. Be familiar with all radar aids to navigation.

3. Understand thoroughly the use of drift meter, sextant and flux gate compass.

4. Be able to perform minor maintenance on all equipment incidental to the performance of his duties.

5. Know the proper use of the flare chute, flare gun, and other identification signals.

BOMBARDIER

Your bombardier must:

1. Understand the bombsight, radar equipment, and automatic pilot insofar as they pertain to bombing.

2. Understand the normal and emergency operation of bombs, bomb racks, switches, controls, releases, doors, etc.

3. Understand and be able to operate the computing RCT sight.
4. Be proficient at pilotage and dead reckoning.
5. Be proficient at target identification.

RADAR OBSERVER

Your radar observer must:

1. Be proficient at pilotage and dead reckoning.
2. Understand the operation of, and be able to use, all available radio and radar equipment for navigation and bombing.
3. Be able to perform minor maintenance on all radar equipment.
4. Be proficient at target identification.

FLIGHT ENGINEER

Your flight engineer is an important member of your B-29 combat team. He runs your airplane while you and your copilot fly it. In actual flight, he relieves you and your copilot of many duties and responsibilities. On the ground, he is your chief liaison with ground crew maintenance. Check your flight engineer frequently to make sure he is on the job. He must:

1. Understand the operation and maintenance of all mechanical equipment.
2. Be thoroughly familiar with the engines and the fuel, oil, and electrical systems.
3. Be thoroughly familiar with the cruise control charts, weights and balance, and all operating procedures.
4. Be thoroughly familiar with the pressurized cabin system.
5. Be thoroughly familiar with the putt-putt and auxiliary electrical system.
6. Be thoroughly familiar with the oxygen system.

7. Be thoroughly familiar with all emergency procedures.

RADIO OPERATOR

Your radio operator must:

1. Be thoroughly familiar with the operation and maintenance of all radio equipment aboard the airplane.
2. Be thoroughly familiar with the use of all radio navigational aids.
3. Be proficient in transmitting and receiving.
4. Be thoroughly familiar with IFF procedures and equipment.
5. Understand the operation and care of the radio compass.
6. Be thoroughly familiar with AAF instrument approach procedures and the signal operation instructions (radio authentication, special codes for the day, weather codes, blinker codes, radio call signs).

CENTRAL FIRE CONTROL SPECIALIST GUNNER

Your central fire control specialist gunner should:

1. Be thoroughly familiar with the care, maintenance, and operation of the entire central fire control system.
2. Be thoroughly familiar with the loading and servicing of the turrets.
3. Be proficient in aircraft identification.

CAREER GUNNERS

Your career gunners must:

1. Know how to operate the computing sight.
2. Be thoroughly familiar with the central fire control system.
3. Know how to load and repair turrets.

CREW DISCIPLINE

Your success as the airplane commander will depend in a large measure on the respect, confidence, and trust which the crew feels for you. It will depend also on how well you maintain crew discipline.

Your position commands obedience and respect. This does not mean that you have to be stiff-necked, overbearing, or aloof. Such characteristics certainly will defeat your purpose.

Be friendly, understanding, but firm. Know your job, and, by the way you perform your duties daily, impress upon the crew that you do know your job. Make fair decisions after due consideration of all the facts involved, but make them in such a way as to impress upon your crew that your decisions are made to stick.

Crew discipline is vitally important, but it is not as difficult a problem as it sounds. Good discipline in an air crew breeds comradeship and high morale. And the combination is unbeatable.

You can be a good CO and still be a regular guy. You can command respect from your men, and still be one of them.

"To associate discipline with informality, comradeship, a leveling of rank, and at times a shift in actual command away from the leader, may be paradoxical," says a former combat group commander. "Certainly, it isn't down the military groove. But it is discipline just the same—and the kind of discipline that brings success in the air."

The way each crew member performs his duties will reflect favorably—or unfavorably—on your ability as airplane commander.

What about your navigator? You can't do his job for him throughout training in the States and then expect him to guide you safely over a thousand miles of water to a speck on the map. Remember that there aren't any check points on the ocean. You have to rely on your navigator. Now is the time to make certain that he knows his job.

Your bombs miss the target. Long hours of flying wasted. Why? It may be because the bombsight gyro was not turned on long enough in advance or because the bombsight was not kept warm by means of the heater so that when the bombardier put his warm face to the eyepiece, it fogged up and was unusable. Who is the culprit? The bombardier, of course, is primarily at fault, but fundamentally your lack of leadership, guidance and inspiration is to blame.



Remember—**NO AIR CREW IS EVER MORE ON THE BALL THAN ITS AIRPLANE COMMANDER**

ENFORCE THESE **Rules** ON EVERY FLIGHT



SMOKING

- a. No smoking in airplane at an altitude of less than 1000 feet.
- b. No smoking during fuel transfer.
- c. Never attempt to throw a lighted cigarette from the airplane. Put it out first.
- d. No smoking in tail gunner's compartment.
- e. No smoking while on oxygen.

PARACHUTES

- a. All persons aboard will wear parachute harness at all times from takeoff to landing.
- b. Each person aboard will have a parachute on every flight.
- c. Have an extra parachute in front and rear pressurized compartments.

PROPELLERS

- a. No person will walk through the propellers at any time.

- b. No person will leave the airplane when propellers are turning unless personally ordered to do so by the airplane commander.

OXYGEN MASKS

Oxygen masks will be carried on all day flights where altitude may exceed 8000 feet for more than 4 hours, and on all night flights.

TRAINING

- a. Tell your crew the purpose of each mission and what you expect each member to accomplish.
- b. Keep the crew busy throughout the flight. Get position reports from the navigator; send them out through the radio operator. Put the engineer to work on the cruise control and maximum range charts and require him to keep a record of engine performance. Give every crew member a workout. Encourage each to use his skill. A team is an active outfit. Make the most of every practice mission.
- c. Practice all emergency procedures at least once a week—bailout, ditching and fire drill.

INSPECTIONS

- a. Check your airplane with reference to the particular mission you are undertaking. Check everything.
- b. Check your crew for equipment, preparedness and understanding.

INTERPHONE

- a. Keep the crew on interphone. Require them to give immediate reports of all aircraft, trains, and ships sighted, with proper identification, just as you would in combat.
- b. Require interphone reports every 15 minutes from all crew members in rear of airplane.



General Description

POWER PLANTS

Your B-29 Superfortress has four 18-cylinder, twin-row R-3350 Wright radial engines, each capable of delivering more than 2200 Hp. The 4-bladed propellers, reduction-gearred to the crankshaft and rotating clockwise when viewed from the rear, are Hamilton Standard constant-speed, full-feathering, hydromatic. Constant-speed control is maintained by governors which are operated from the airplane commander's aisle stand. (See also **Curtiss Electric Propeller System.**)

Each engine has two exhaust-driven turbo-superchargers mounted vertically at the sides of the nacelle. The turbo boost on all four engines is controlled simultaneously by a Minneapolis-Honeywell electronic turbo-supercharger control system operated by a single manual control knob on the airplane commander's aisle stand.

Engines may have either conventional carburetors or fuel injection systems.

Vacuum pumps, one on each engine, provide vacuum for the cameras, de-icer boots, and instruments, and pressure for inflating the de-icer boots. Either inboard vacuum pump may be used for vacuum; the other three pumps provide pressure for the de-icer boots.

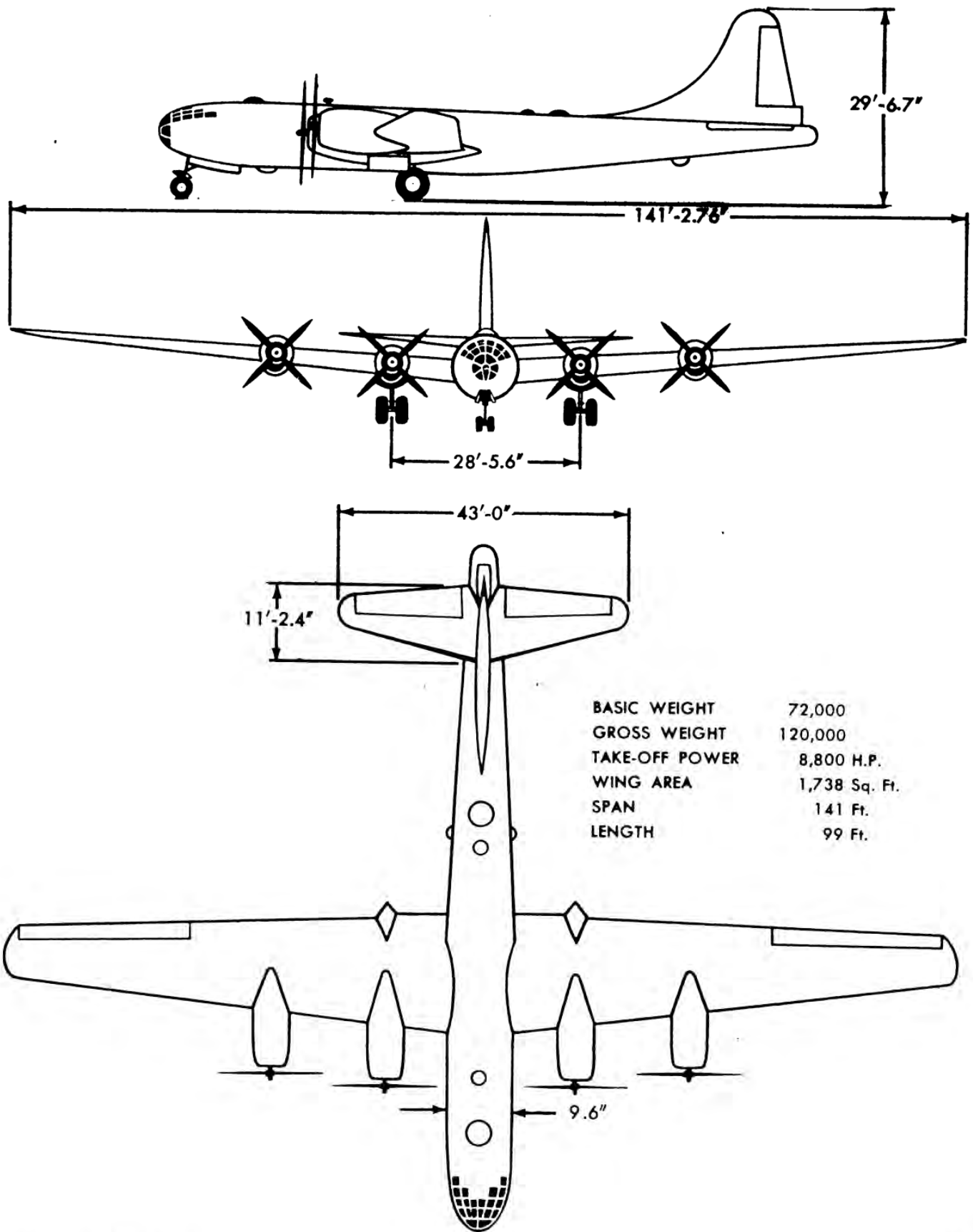

FLIGHT ENGINEER'S PANEL

Besides throttles and mixture controls the flight engineer's panel mounts the following engine controls and gages:

1. Cowl flap switches and indicators
2. Intercooler switches and indicators
3. Oil dilution switches
4. Starter switches
5. Oil cooler switches
6. Prop anti-icer and de-icer switches
7. Main tank shut-off valve switches
8. Engine shut-off valve switches
9. Manifold shut-off valve switches
10. Generator switches

11. Battery switch
12. Inverter switch
13. Fuel tank valve (center wing)
14. Booster pumps switch (manifold transfer)
15. Pitot heater switches
16. Inverter switch circuit breakers
17. Hydraulic pump over-ride switch
18. Engine fire extinguisher controls and selector valve
19. Ignition switches
20. Putt-putt ignition switch and light
21. Engine primer switches
22. Fuel booster pump switches
23. Starter circuit breaker switches
24. Cabin air rate-of-flow gages (2)
25. Generator ammeters
26. Fuel flow meters (2)
27. Two rate-of-climb indicators (outside and cabin)
28. Two altimeters (outside and cabin)
29. Airspeed indicator
30. Cabin differential pressure gage
31. All engine, fuel, and oil gages
32. Clock
33. Cabin air temperature gage
34. Cabin air temperature rheostat
35. Suction gage
36. Circuit breakers for manifold transfer system
37. Main and emergency hydraulic system pressure gages
38. Emergency hydraulic system filler valve
39. Cabin air conditioning switches
40. Cabin pressure warning horn switch
41. Wheel well light switch
42. Fluorescent light rheostats
43. Free air temperature gage
44. Cabin air valve levers
45. Vacuum pump selector lever

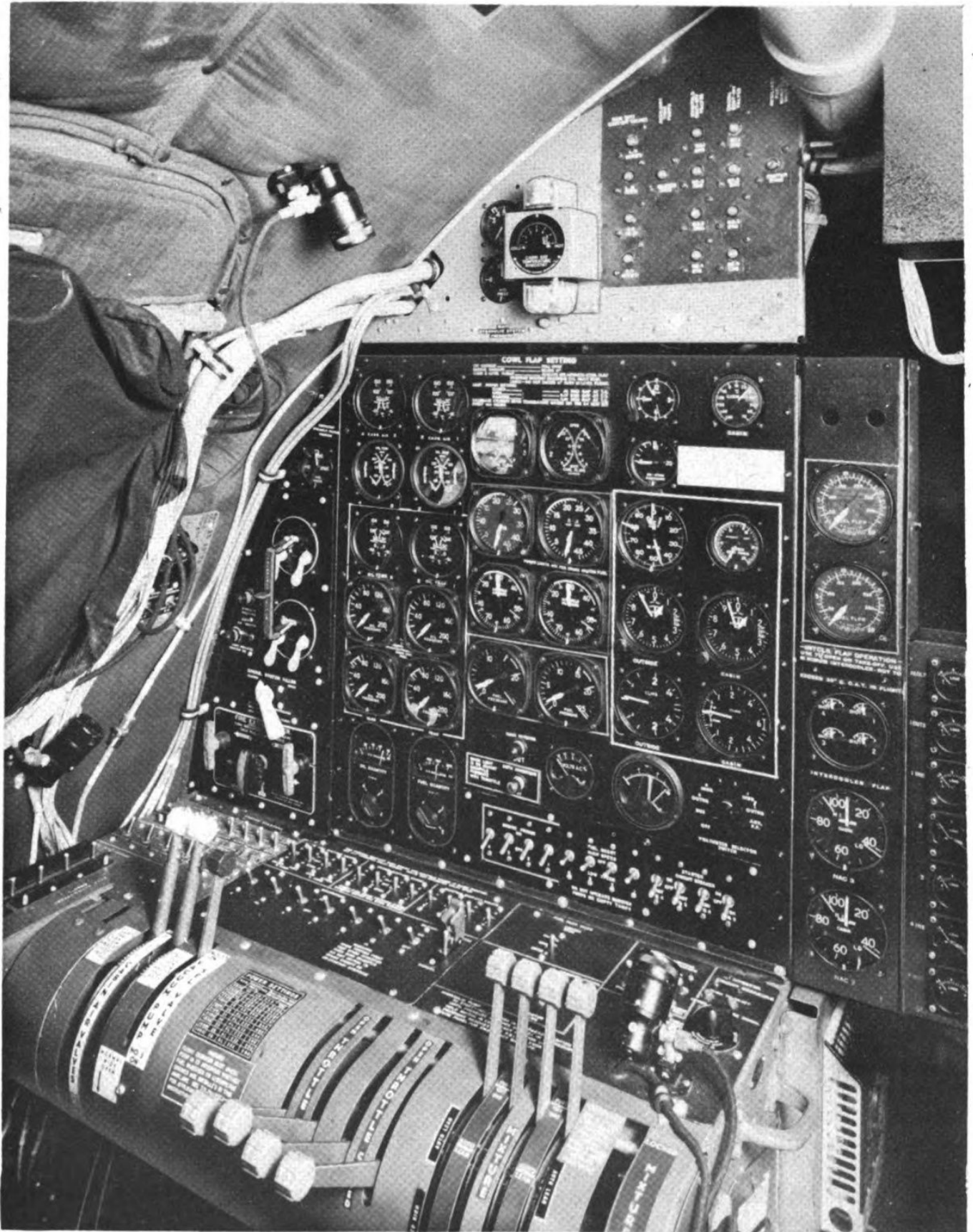

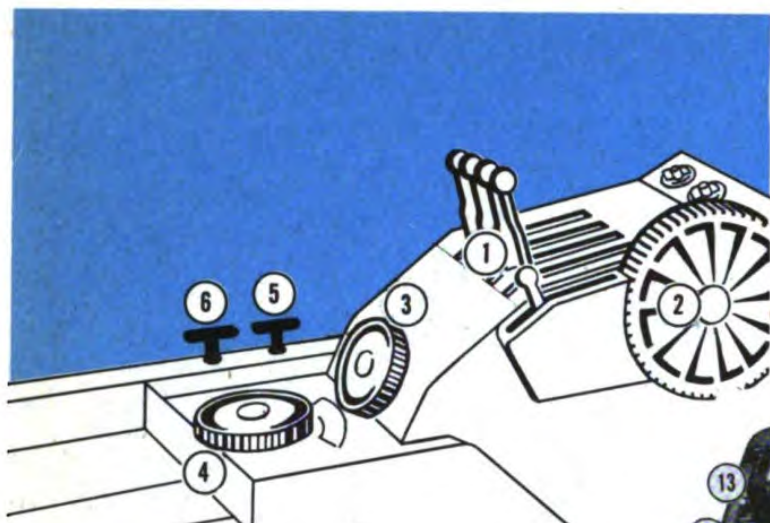

CONTROLS

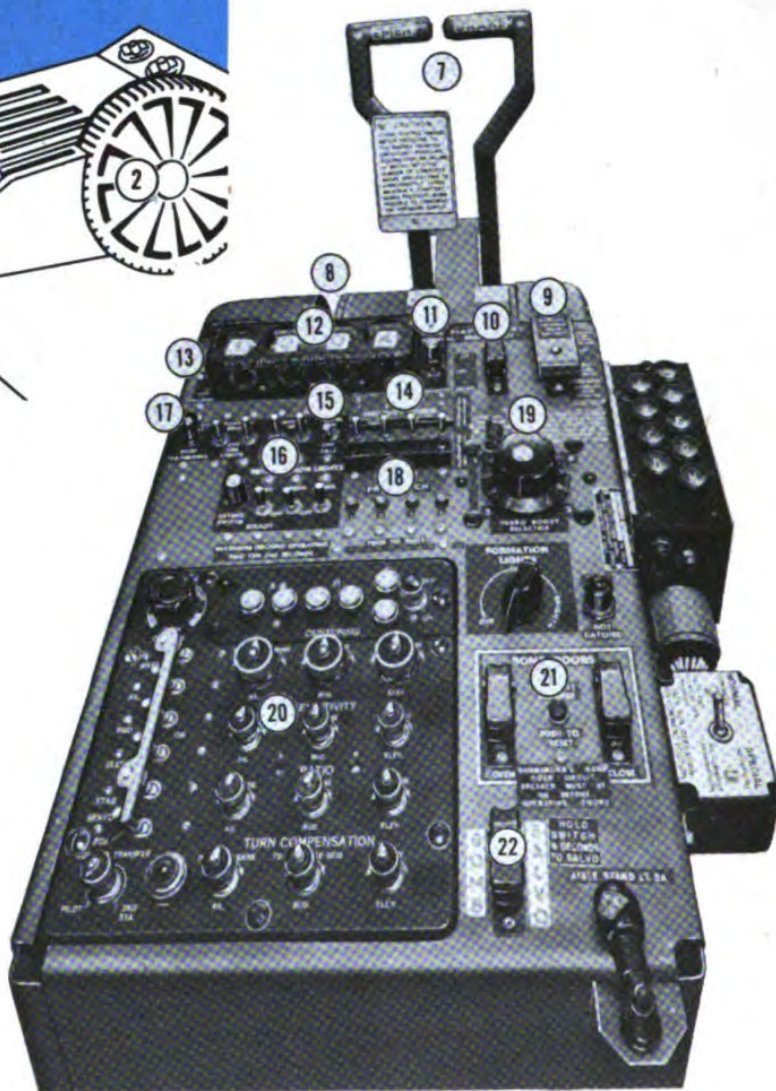

From the airplane commander's and copilot's viewpoint, the controls on the B-29 have been simplified. The majority of the power plant controls and most of the basic electrical and mechanical system controls are on the flight engineer's stand directly in back of the copilot.

Both airplane commander and copilot have control stands (see illustration) on which throttles (1), elevator trim tab (2), aileron trim tab (3), and rudder trim tab (4) are mounted. The emergency cabin pressure (5) and emergency bomb door (6) releases are at the rear of the airplane commander's control stand.

The emergency brake levers (7), control surface lock (8), landing gear switch (9), emergency wing flap control switch (10), normal wing flap control switch (11), propeller feathering switches (12), alarm bell switch (13), propeller increase and decrease rpm switches (14), phone-call signal light switch (15), light switches (16), propeller feathering circuit breaker re-set switch (17), propeller governor circuit breaker re-sets (18), turbo boost selector (19), C-1 automatic pilot controls (20), pneumatic bomb door switches (21), bomb salvo switch (22) are on the aisle stand to the right of the airplane commander's seat.

AIRPLANE COMMANDER'S PANEL

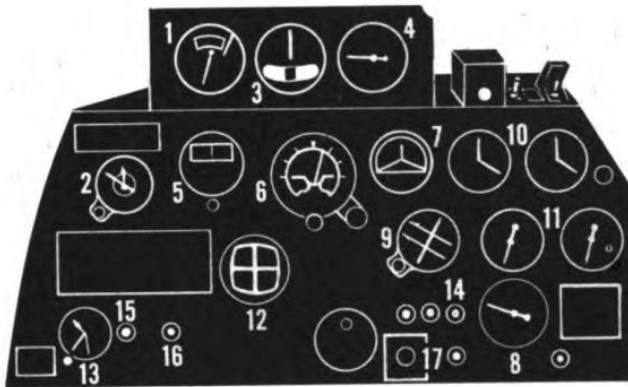

Except for manifold pressure gages and tachometers, the instruments on the airplane commander's panel are all flight instruments:

1. Airspeed indicator
2. Altimeter
3. Bank-and-turn indicator
4. Rate-of-climb indicator
5. Turn indicator
6. Gyro-horizon
7. Pilot direction indicator (PDI)
8. Radio compass
9. Flux gate compass
10. Manifold pressure gages
11. Tachometers
12. Blind-landing indicator
13. Clock
14. Turret warning lights
15. Bomb release indicator light
16. Vacuum warning light
17. Inverter warning lights

COPILOT'S INSTRUMENT PANEL

The instruments mounted on the copilot's instrument panel are:

1. Airspeed indicator
2. Altimeter
3. Bank-and-turn indicator
4. Rate-of-climb indicator
5. Turn indicator
6. Magnetic compass
7. Gyro-horizon
8. Flap position indicator
9. Propeller rpm limit indicator lights
10. Landing gear indicator lights

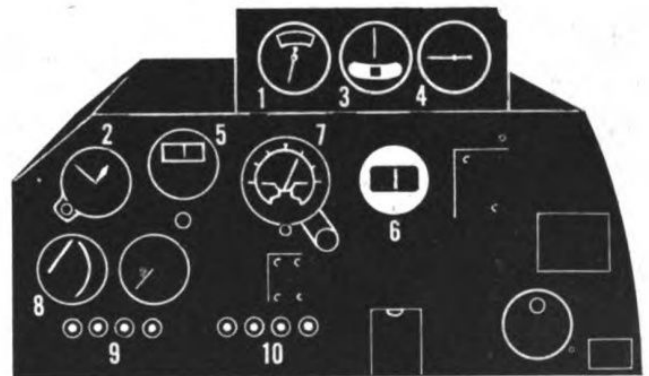

FLIGHT CONTROLS

The flight controls are conventional and the forces necessary to move them are light, even at high speeds—a surprising fact to most pilots the first time they fly the B-29. The elevators are similar to those on the B-17. The ailerons, although considerably larger than those on the B-17, are so rigged that they can be easily moved 18° up or down. The rudder gives maximum possible control and yet can be moved

easily without the use of power boosts.

Wing flaps and tricycle landing gear are lowered and raised by reversible electric motors. The Fowler-type wing flaps travel on track and roller mechanisms in such a manner that they project beyond the trailing edge of the wing when they are extended. Under normal operation the landing gear can be lowered in 40 seconds.

AIRPLANE COMMANDER'S

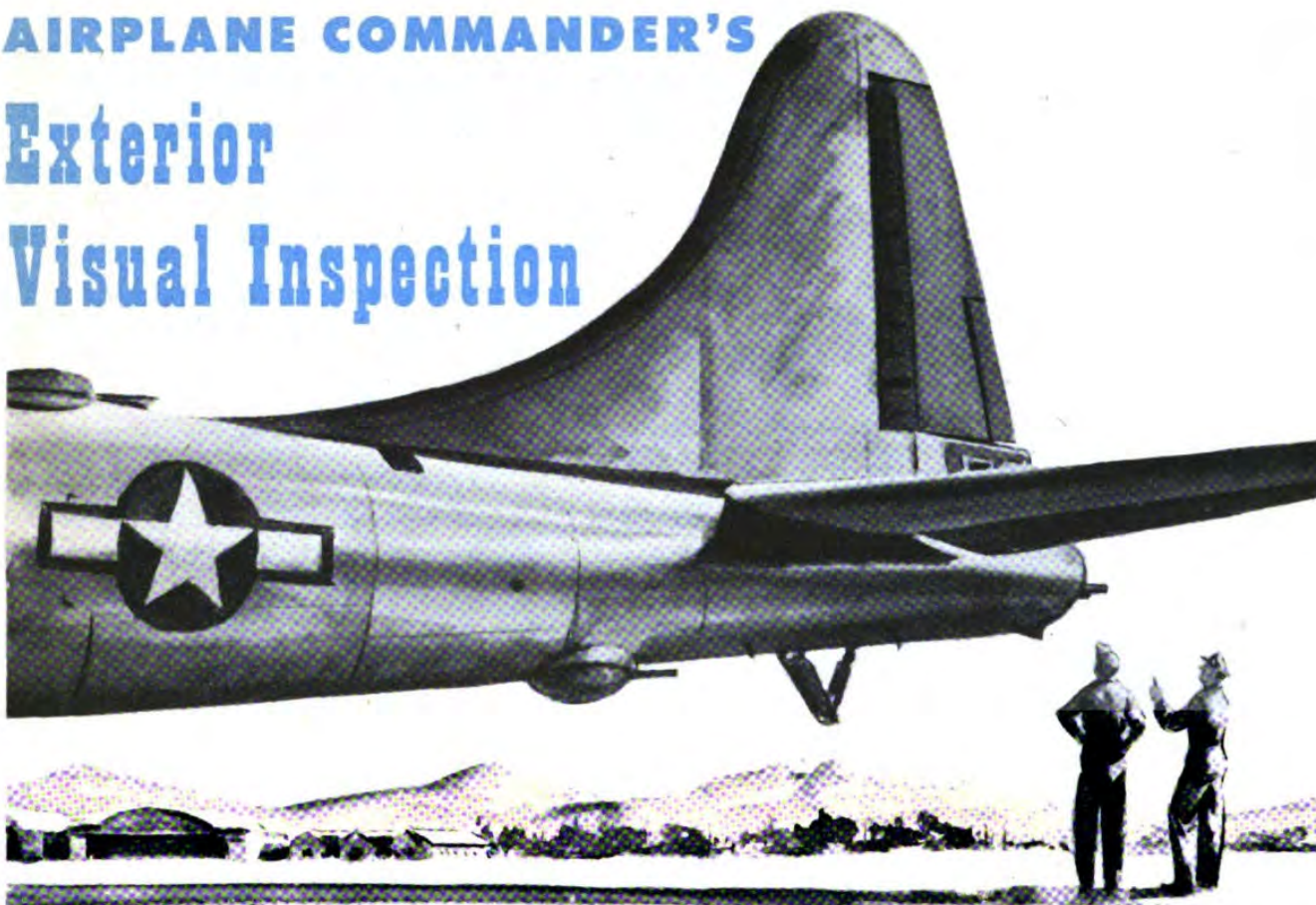
Exterior
Visual Inspection

You make this exterior visual inspection for the purpose of assuring yourself that all pre-flight maintenance, service, and inspection procedures have been accomplished and the airplane is ready to fly.

In your early training, make the checks listed below carefully and completely. Omit nothing. Follow the route shown in the diagram.

As your training and familiarization with the airplane progress you will be able to condense and speed up this inspection so that it does not hold up your preparation for flight, but still accomplishes its purpose: **a careful re-check of the engineer's preflight, to be sure that he has missed nothing.**

1. Place parachutes and personal equipment on ramp to left of nose section. (This will prevent confusion when airplane commander calls for crew inspection.)

2. Master, battery and magneto switches OFF. Airplane commander enters forward pressurized compartment and checks master, battery and magneto switches OFF. He then informs

the crew, permitting them to check for liquid locks.

3. Test for liquid lock. When the airplane commander informs the crew that the switches are OFF, each prop will be pulled through four blades to test for liquid lock. (Do not pull blades in reverse in an attempt to break a lock. This is merely a preliminary inspection and does not replace procedure of pulling props through 12 blades before starting.) Look in air scoops—free from foreign objects.

4. Form 1A and loading list. Check the Form 1A and sign (if necessary) the exceptional release. Fill out and sign the loading list.

5. Internal inspection of forward pressurized compartment. Check general condition and proper stowage of all equipment.

a. Fire extinguisher—securely mounted and actuating valve safetied.

b. Ditching braces—stowed.

c. Compressor circuit breakers—ON.

d. Pressure bulkhead door (Sta. 218)—check movement and closed position for warpage.

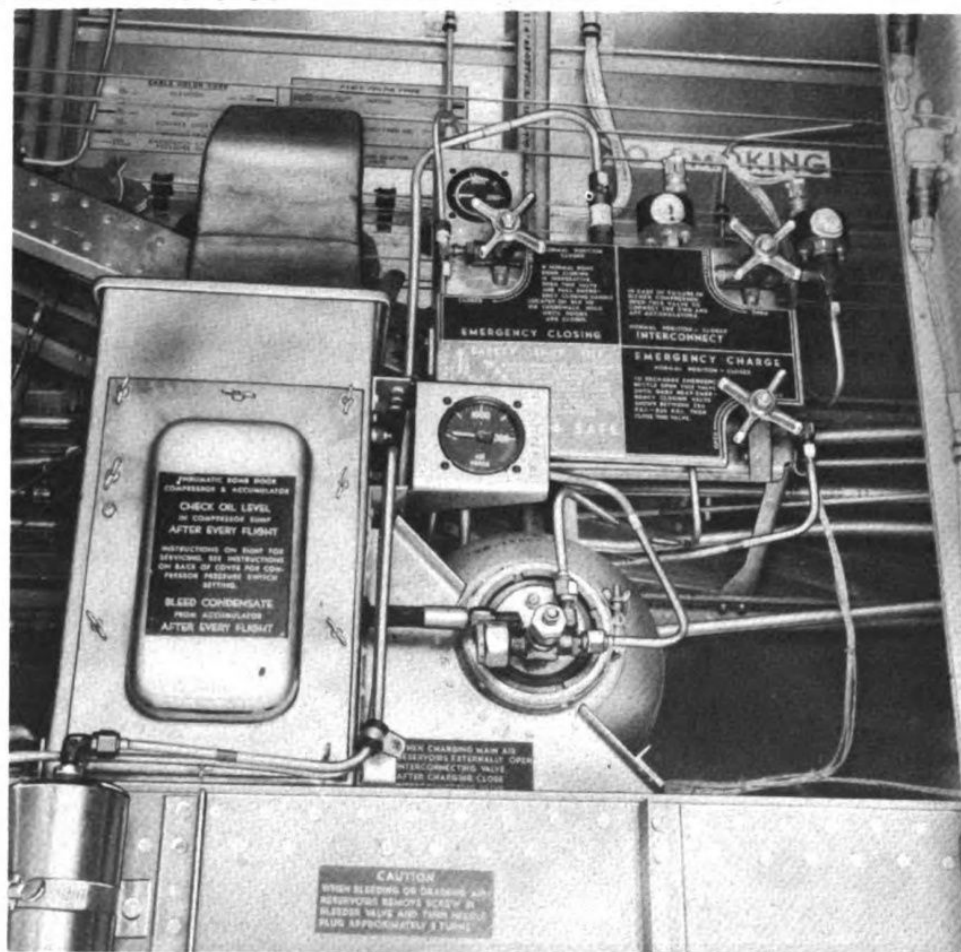
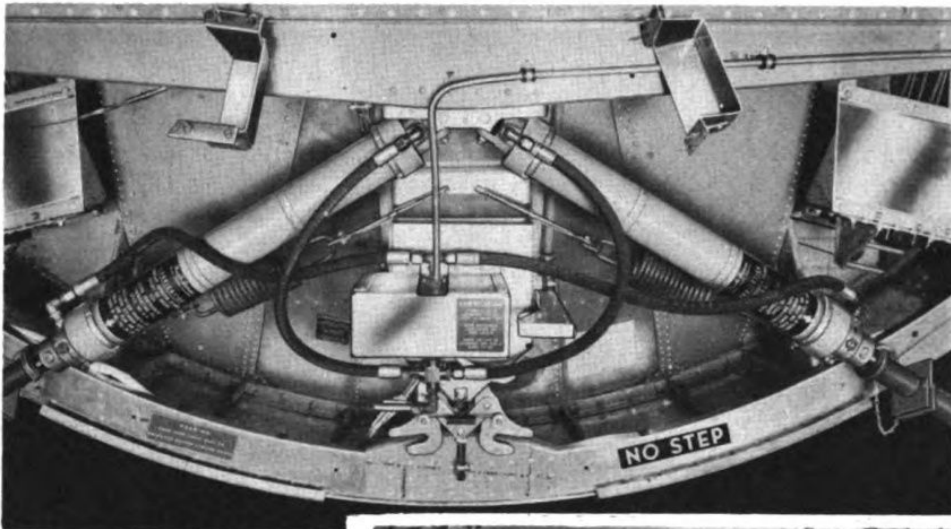

- 6. Forward bomb bay.
 - a. Ditching braces—stowed.
 - b. Bomb door safety down lock—in place.
 - c. Emergency release cables—check tension, wear and freedom from foreign objects.
 - d. Tank safety switch—ON.
 - e. Bomb door safety valves—OFF.
 - f. Accumulator pressure—1200-1500 psi.
 - g. Control cables—check tension, wear and freedom from objects.
 - h. Loading—visually check loading and number of bombs.

7. Nosewheel well.

a. Nosewheel crank—stowed.

b. Engine fire extinguishers—check red disc at end of line running down each bottle.

If discs are not present, or if safety wire is broken or missing, new CO₂ cylinders should be installed before flight. They should be safetied with fine brass wire. If the wire is too heavy, engineer will be unable to pull the handle.

c. Nosewheel well light—bulb okay and securely socketed. Check operation if contemplating night flight.

d. Nosewheel solenoid shield securely mounted.

e. Cannon plug—all cannon plugs should be tight and taped as an added precaution. If the

rotating collar is not screwed tightly, engine vibration can shake loose the cannon plug connections.

f. Nosewheel well doors and hinges—check: condition and security of attachment of doors; latch spring on actuating mechanism for tension or distortion; control cables for tension, wear, and freedom of movement.

g. Nosegear limit switches—access doors to limit switches tight and screws safetied.

h. Electrical or manual emergency system—check cables for tension, wear and freedom from objects.

i. External power plug-in box—socket clean and box secure.

j. Nosewheel inspection window—cleanliness and condition.

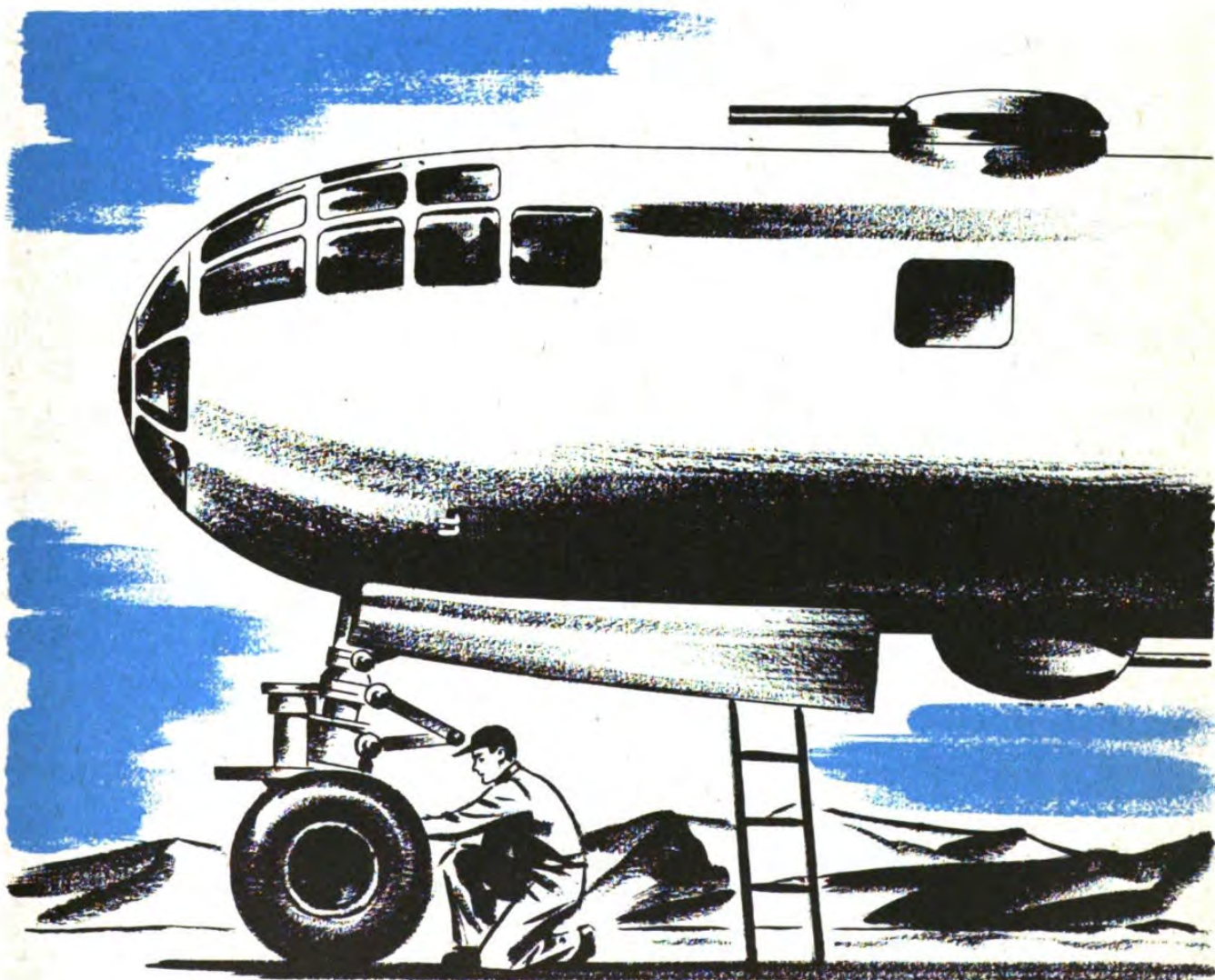



8. Nosewheel

- a. Down lock—in place.
- b. Torsion links—alignment of pins and signs of failure.
- c. Micro-safety switch—check for damage.
- d. Shimmy damper—check oil level. (The top of the pin should be even with groove—plus or minus $3/16$ ".)
- e. Strut inflation—10" between pin centers (tolerance is $+1/2$ " and -1 "). Check for dirt on oleo and for leaks at filler valves and main packing nut.
- f. Wheels—inspect for: mud, grass, ice, etc.; distorted rim flanges and ribs; security and presence of nuts, bolts and cotter pins.

g. Tires—check: proper and even inflation; excessive oil or grease; cuts, blisters, slippage, pulling away from rim, and chafing.

h. Centering device—security of mount.

9. Nose section.

a. Greenhouse—check cleanliness and condition.

b. Pitot tubes—covers off and tubes open.

c. A.P.I. vent—open.

d. Schvien regulator vent—open.

e. Static sources—open.

f. Forward turrets—stowed, domes and gun enclosures on and locked, and access doors closed.

g. Fuel tank vents—open.

10. Leading edge of wing between fuselage and No. 2 nacelle:

a. Inspect for cracks, corrosion, wrinkles and loose or missing rivets.

b. Aftercooler vent—open.

11. Front of No. 2 engine nacelle.

a. Prop blades—check for nicks, cracks and bends.

b. Thrust bearing and prop dome—check general condition.

c. Prop governor—check for oil leaks.

d. Cylinders—check for damaged or broken fins.

e. Bonding—check connections.

f. Sparkplug leads—check all visible leads for condition.

g. Nose cowl—check: rigidity, loose rivets or dzus fasteners, and dents which may hamper the airflow.

12. Leading edge of wing between No. 1 and No. 2 engine nacelle—inspect for cracks, corrosion, wrinkles and loose or missing rivets.

13. Front of No. 1 engine nacelle. Same as No. 11.

14. Leading edge of outboard wing. Same as No. 12.

15. Left wingtip—check for dents, cracks and loose or missing rivets.

a. Left navigation light—general condition (check operation if anticipating night flight).

b. Static discharge wicks—normally three on a wingtip.

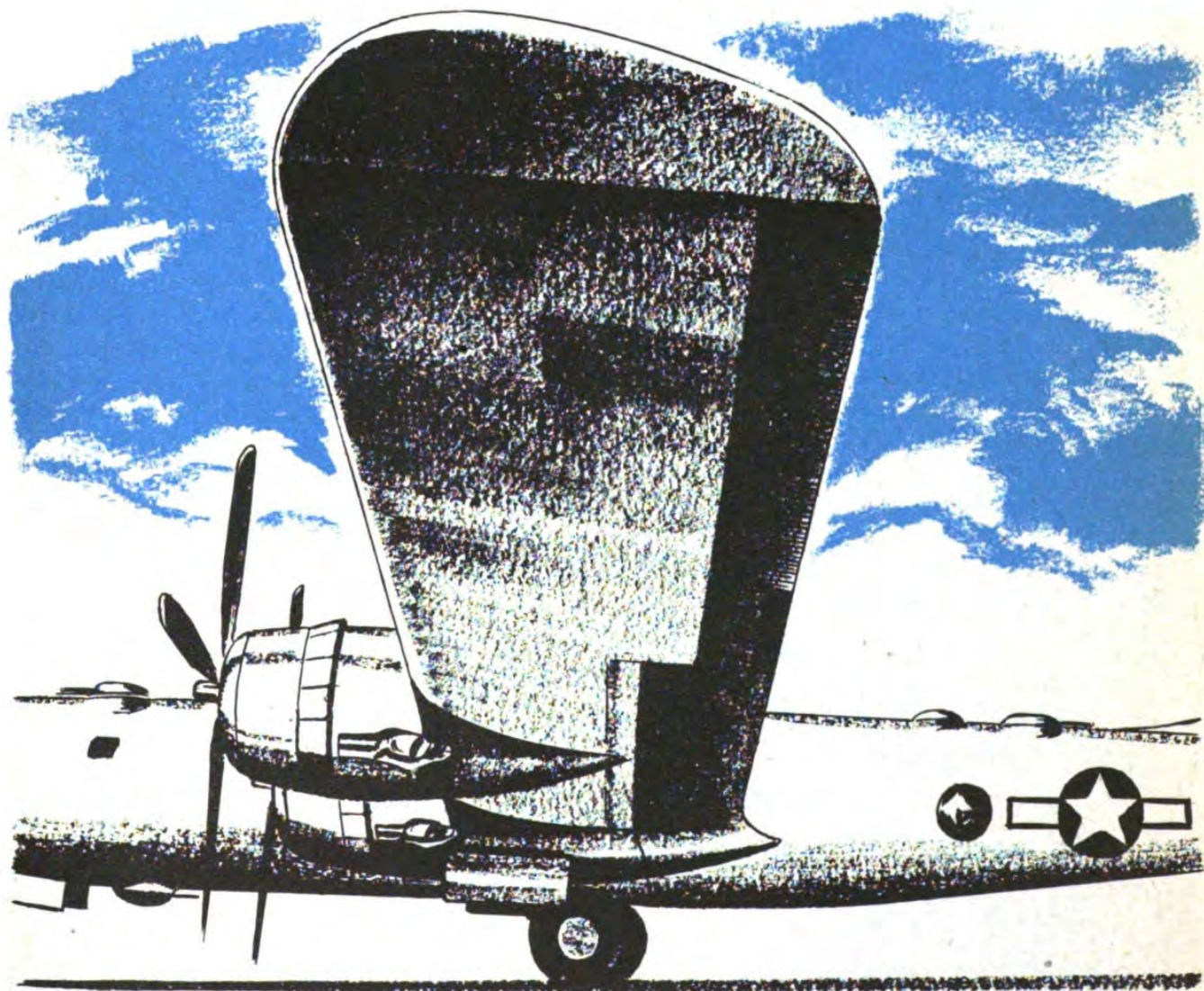

RESTRICTED

16. Left outer wing panel—check for: wrinkles, holes, dents, loose or missing rivets, fuel leaking from seams, loose fasteners on inspection plates.

- a. Aileron—check for holes, wrinkles, cracks, and loose or missing rivets.
- b. Trim tab—check condition and position of trim tab and re-check trim tab indicator.
- c. Hinge pin retainers—check for presence.
- d. Landing light—check cleanliness and condition. If anticipating night flight, check operation.

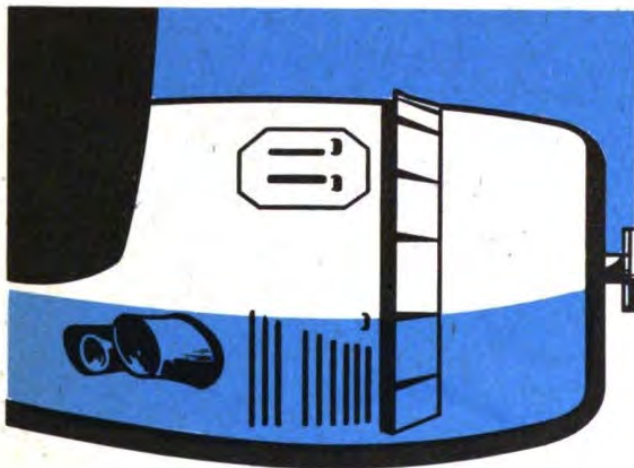

17. No. 1 nacelle (left side)—check for excessive oil or grease which is a definite fire hazard.

- a. Cowling—check for dents, loose rivets, and security of mounting.

b. Cowl flaps—check for cracks, dents, and security. Inspect all flexible shafts for kinks and chafing.

c. Bonding, sparkplug leads, and cooling fins—check condition and security.

d. Intake pipes—check for rigidity and signs of failure, also leaks denoted by bluish dye color.

e. Fuel booster pump drain—open.

f. Exhaust stacks and turbo flight hood—check for broken lugs, studs, and bolts, cracked connections, and rigidity. Check exhaust expansion collar.

g. Top turbo head deflector in top of turbo wall—check for signs of failure.

h. Position of waste gate—open.

i. Oil coolers—open.

18. No. 1 nacelle (right side).

a. Waste gate—open.

b. Top turbo head deflector—same as No. 17g.

c. Intake stacks—same as No. 17d.

d. Exhaust stacks and turbo flight hood—same as No. 17f.

e. Cowl flaps—same as No. 17b.

f. Cowling—same as No. 17a.

19. Left inboard wing panel — check for: wrinkles, holes, dents, and loose or missing rivets; inspection plates for loose fasteners, and seams for fuel leaks.

a. Flaps—check for dents, cracks, loose or missing rivets, warpage and play (tolerance 9/10" up); check alignment in up position.

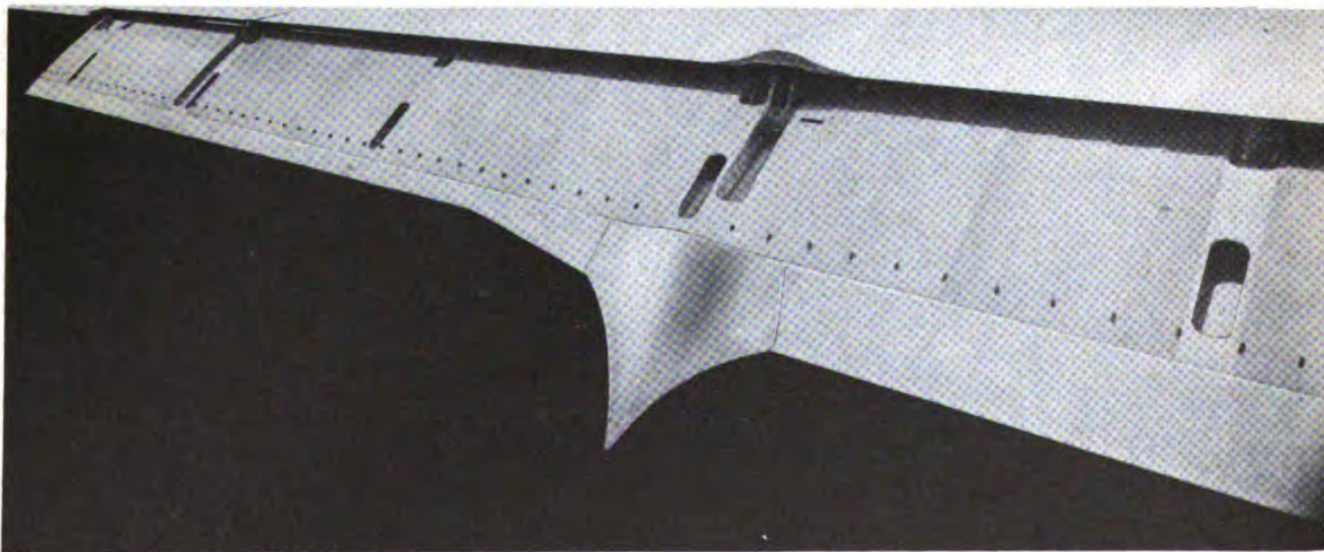



- 20. No. 2 nacelle (left side)—same as No. 17.
- 21. Left main gear and wheel well.
 - a. Left well door—check: condition and security of attachment, control cables for freedom of movement, tension and wear, and latch spring on actuating mechanism for tension.
 - b. Down lock—in place.
 - c. Gear motors (emergency and normal)—check cannon plugs for looseness and taping. Check connections, security of mounting and general condition of motors.
 - d. Well light—check bulb for condition and tightness. If night flight, check operation.
 - e. Emergency door releases—check for tension, wear and freedom of movement.
 - f. Relay switch—check security of mounting.
 - g. Fluid leaks in upper aft of nacelle—check fuel and hydraulic lines for leaks and chafing. This includes a check of the booster valves.
 - h. Hydraulic swivel lines between wheels—check for loose connections and leaks.
 - i. Drag strut—check for alignment and signs of failure.

- j. Torsion links—check for alignment of pins and signs of failure.
- k. Left wheel and tire—check wheel for freedom from mud, grass, ice, etc., distorted rim flanges and ribs, security and presence of nuts, bolts and cotter pins. Check tire for proper and even inflation, excessive oil or grease, cuts, blisters, slippage, and pulling away from rims.
 - l. Outboard and inboard brakes—check the bottom of the wheel for signs of leaks in the expander tubes.
 - m. Main gear torsion link—check for alignment and signs of failure.
 - n. Ground wire — securely attached and grounded.
 - o. Micro-safety switch—check for damage.
 - p. Strut inflation— $13\frac{1}{4}$ " between pin centers (tolerance $+\frac{1}{2}$ " and -1 ").
 - q. Right tire and wheel—same as No. 21k.
 - r. Outboard and inboard brakes — same as No. 21l.
 - s. Right well door—same as No. 21a.
- 22. No. 2 nacelle (right side)—same as No. 18.

RESTRICTED

23

RESTRICTED

23. Absolute altimeter antenna—check condition and security of mounting.

24. Left wing surfaces—check for loose rivets, unfastened inspection plates, cracks, wrinkles, and signs of excessive oil leaks from the engines.

25. Left blister—check for cleanliness and condition.

26. Upper turret—same as No. 9f.

27. Camera doors—in place.

28. Auxiliary power plant exhaust—open.

29. Lower rear turret—same as No. 9f.

30. Marker beacon antenna—check condition and security of mount.

31. Tailskid—check for leaks on strut and signs of failure.

32. Left horizontal stabilizer and elevator—inspect for corrosion, wrinkles, cracks, dents, and loose or missing rivets.

a. Static discharge wicks—check presence of

two on each stabilizer and three on rudder.

b. Trim tab—check condition and position and re-check position later with indicator in the cockpit.

c. Hinge pin retainers—check presence.

33. Tail turret—gun stowed and access covers on.

34. Condition of lights—check condition of all lights visible. If anticipating night flight, check operation.

35. Vertical stabilizer and rudder—inspect for corrosion, wrinkles, cracks, dents, and loose or missing rivets.

a. Trim tab—check condition and position and re-check position later with indicators in cockpit.

36. Right horizontal stabilizer — same as No. 32.

37. Command and liaison antenna—check for security, corrosion, and condition of leads.

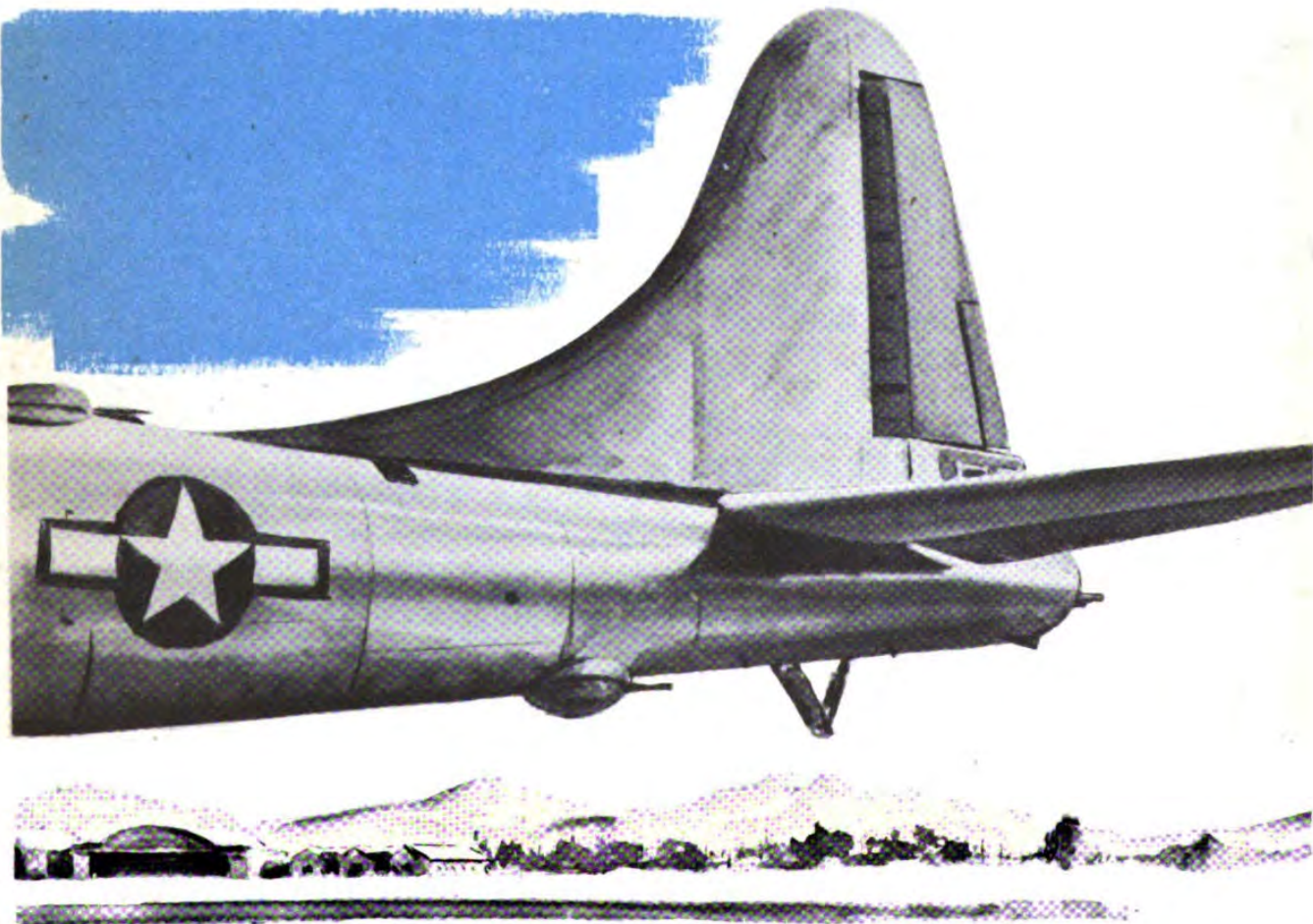

38. Interior of rear unpressurized compartment—check for proper stowage of equipment, loose rags, and general condition.

- a. Starter crank—stowed.
- b. Fire extinguisher—same as No. 5a.
- c. Putt-putt and battery — examine exterior for loose parts, leaks, and loose electrical connections. Check the oil level with the gage. (Should be up to F mark.) Check fuel. Fuel cap tight.

d. Rope for starting putt-putt—stowed.

e. Control cables — check for tension, wear, and freedom from foreign objects.

39. Rear pressurized compartment.

a. Emergency cabin pressure relief valve—check seating and security.

b. Vacuum relief valve—check for position, seal, and freedom of movement.

c. Pressure bulkhead door (Sta. 834)—check for movement and closed position for warpage.

d. Fire extinguisher—same as No. 5a.

e. Aldis lamp—OK.

f. Electric salvo switch—circuit breakers ON.

g. VHF and IFF switches—ON.

h. Pressure regulators—check general condition and rigidity of both regulators. (Knurled knobs should be screwed down tightly.)

i. Emergency cabin pressure release—check seating security and general condition of latching mechanism.

j. Manual salvo T-handle — in place with guard down.

k. Pressure bulkhead door (Sta. 646)—check movement and closed position for warpage.

l. Ditching braces—stowed.

m. CFC dome—cleanliness and condition.

40. Rear bomb bay.

a. Bomb door safety down lock—in place.

b. Bomb bay tank safety switch—ON.

c. Emergency main gear hand cranks — stowed.

d. Emergency landing gear T-handle — in place. Hand crank gear boxes — sockets free from dirt and foreign matter.

e. Portable motor — check condition and security.

f. Bomb door safety valves—OFF.

g. Accumulator pressure—1200-1500 psi.

h. Loading—visually check loading and number of bombs.

i. Control cables — check for tension, wear, and freedom from foreign objects.

41. Right blister—cleanliness and condition.

42. Right wing surfaces—same as No. 24.

43. Rear bomb bay tank vent—open.

44. Rear bomb bay doors and salvo releases—check for dents and warpage. Check cables for tension, wear, and freedom of movement.

45. Rear bomb bay compressor air intake and exhaust—open.

46. Midwing section.

a. Radar dome—retracted. Eagle wing—check for dents, cracks, wrinkles, and loose or missing rivets.

b. Midwing tank—check fuel load (gage) and filler cap in place.

c. Fuel lines—check for leaks, loose connections, and chafing.

d. Transfer pumps—check for leaks, rigidity, and general condition.

e. C-1—test connection.

47. Front bomb bay doors and salvo release—same as No. 44. The preflight from this point progresses as shown in the diagram on page 17. Consult the method of inspection of the various parts of the left side of the airplane for reference in inspecting similar parts of the right side.

WEIGHT AND CG CHECKED

Flight engineer will hand the airplane commander for approval and signature the weight and balance sheet (Form F). Airplane commander will see that CG is between limits (minimum between 18% and 24%, maximum at 34%).

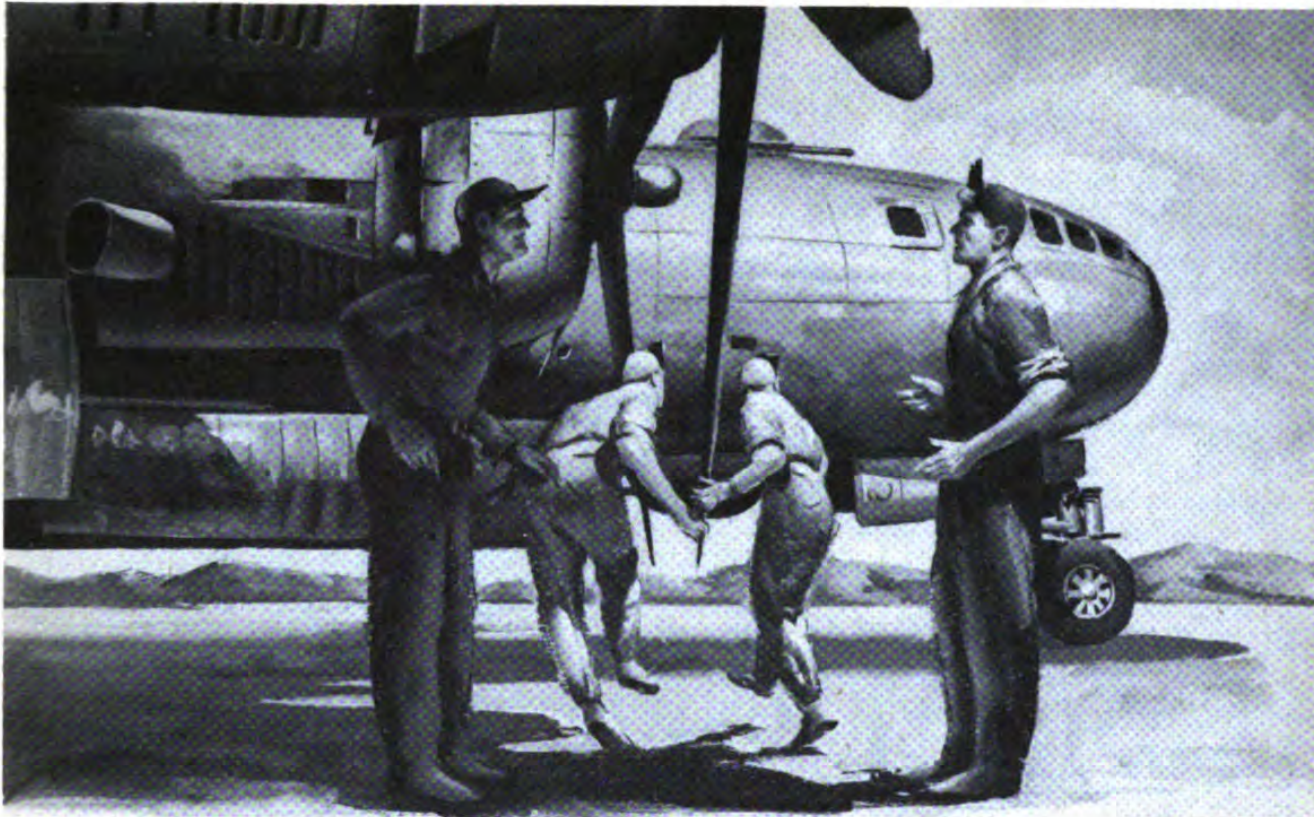

CREW INSPECTION COMPLETED

Airplane commander will enter the airplane, see that all ignition switches are turned off and signal the other crew members or the ground crew to pull the props through, provided the engines have been cut more than 30 minutes. Props should be pulled through at least 12 blades, with not more than two men to a blade. If prop seems to stick, remove plugs from bottom cylinders, pull the prop through to remove excess oil from the cylinders, install clean plugs and pull the prop through 12 blades. (Do not attempt to relieve a liquid lock by applying pressure or by pulling the prop backwards.)

Airplane commander will then have crew line up to the left of the airplane's nose in the following order: copilot, bombardier, navigator, flight engineer, radar observer, radio operator, gunners, and passengers. Crew will then be inspected for physical condition and equipment, including oxygen masks, parachutes, flying clothing, and identification tags. (If dirty ramp conditions exist, crew members may place parachutes and other flying equipment in the airplane during preflight. However, parachutes

will be worn and all other flying equipment will be carried at crew inspection. It is definitely the airplane commander's responsibility to inspect the crew and all their equipment before flight.)

Airplane commander will see that each crew member is familiar with his duties and with emergency procedures. After completing this inspection, crew members will enter the airplane and begin checklists for their stations.

NOTE

Prompt discovery of a liquid lock may prevent a late takeoff. The first crew members to reach the airplane will (after checking all ignition and battery switches OFF) pull each prop through four blades. This is merely a preliminary inspection and does not replace the procedure explained above. Each prop will be pulled through 12 blades immediately before crew inspection.

Pilots' Checklist

BEFORE STARTING

1. PILOTS' PREFLIGHT
2. FORM 1A, LOADING LIST WEIGHT AND BALANCE
3. CREW INSPECTION
4. LANDING GEAR DOWN LOCK
BOMB BAY DOOR LOCK
5. PARACHUTES
6. CLOTHING
7. LIFE PRESERVERS
8. SEATS AND PEDALS
9. PARKING BRAKES AND CHOCKS
10. SAFETY BELTS
11. EMERGENCY LANDING GEAR DOOR RELEASE
12. EMERGENCY BOMB RELEASE
13. EMERGENCY CABIN PRESSURE RELEASE
14. LANDING GEAR TRANSFER SWITCH
15. OVERCONTROL
16. LANDING GEAR SWITCH AND FUSE
17. BATTERY SWITCH
18. HYDRAULIC PRESSURE
19. FLIGHT CONTROLS
20. RADIO
21. ALTIMETERS
22. TURRETS
23. LIGHTS
24. OXYGEN PRESSURE
25. PROPELLERS
26. TURBOS
27. FLIGHT ENGINEER'S REPORT
28. STAND CLEAR—FIRE GUARD

AIRPLANE COMMANDER

- COMPLETED
 CHECKED
 COMPLETED
 REMOVED
 REMOVED
 CHECKED
 CHECKED
 CHECKED
 ADJUSTED
 SET AND IN PLACE,
 LEFT
 ADJUSTED AND
 FASTENED
 IN PLACE
 IN PLACE
 IN PLACE
 NORMAL
 ENGAGED
- CHECKED
 SET
 STOWED
 CHECKED
 _____ PSI
 HIGH RPM
 OFF
- CLEAR LEFT

COPILOT

- CHECKED
 CHECKED
 CHECKED
 ADJUSTED
 IN PLACE, RIGHT
 ADJUSTED AND
 FASTENED
- SWITCH DOWN, FUSE
 CHECKED
 ON
 _____ PSI
 CHECKED
 CHECKED
 SET
 CHECKED
 _____ PSI
- ENGINEER'S REPORT
 CLEAR RIGHT

BEFORE TAXIING

1. VACUUM
2. GYROS
3. INSTRUMENTS
4. ALARM BELL
5. PHONE CALL—SIGNAL LIGHT
6. COMBAT STATION REPORT
7. CHOCKS
8. BOMB BAY DOORS
9. PARKING BRAKES
10. EMERGENCY BRAKES

- UNCAGED
 CHECKED
- OUT LEFT
- OFF
 CHECKED

- CHECKED
 UNCAGED
 CHECKED
- CHECKED
- OUT RIGHT
 CLOSED
 OFF—READY TO TAXI

RESTRICTED

AIRPLANE
COMMANDER

COPILOT

BEFORE TAKEOFF

1. NOSEWHEEL
2. ENGINE RUN-UP
3. WING FLAPS
4. TRIM TABS
5. AUTOPILOT
6. WINDOWS AND HATCHES
7. TURBOS
8. PROPELLERS
9. CREW
10. RADIO CALL
11. THROTTLE BRAKE
12. FLIGHT CONTROLS

NEUTRAL
OFF
CLOSED

COMPLETED
ADJUSTED
CHECKED

STRAIGHT

SET TO 25°

CLOSED
SET FOR TAKEOFF
HIGH RPM
READY FOR TAKEOFF

BEFORE LANDING

1. CREW
2. RADIO CALL
3. ALTIMETER
4. AUTOPILOT
5. TURRETS
6. HYDRAULIC PRESSURE
7. PROPELLERS
8. LANDING GEAR
9. ENGINEER'S REPORT
10. STALLING SPEED
11. WING FLAPS
12. TURBOS

COMPLETED
SET
OFF
STOWED

PREPARE FOR LANDING

SET

____ PSI
2400 RPM
DOWN, GREEN LIGHTS
ON
GROSS WEIGHT ____ LBS.
PUTT-PUTT ON LINE
READY TO LAND
____ MPH
AS REQUESTED
SET

AFTER LANDING

1. HYDRAULIC PRESSURE
2. TURBOS
3. PROPELLERS
4. WING FLAPS
5. PARKING BRAKES
6. BOMB BAY DOORS
7. ENGINES
8. RADIO
9. CONTROLS
10. CHOCKS
11. BRAKES
12. FORMS 1 AND 1A
13. CREW INSPECTION

SET

OFF
LOCKED
IN PLACE LEFT
OFF
ACCOMPLISHED

OK
OFF
HIGH RPM
UP WHEN REQUESTED

OPEN
RUN-UP AND CUT
OFF
IN PLACE RIGHT

Before Starting

1-3. When you have completed your visual check (items 1 to 3 on your checklist) and have climbed into your seat beside your copilot, you are ready for the rest of the Before Starting Checklist.

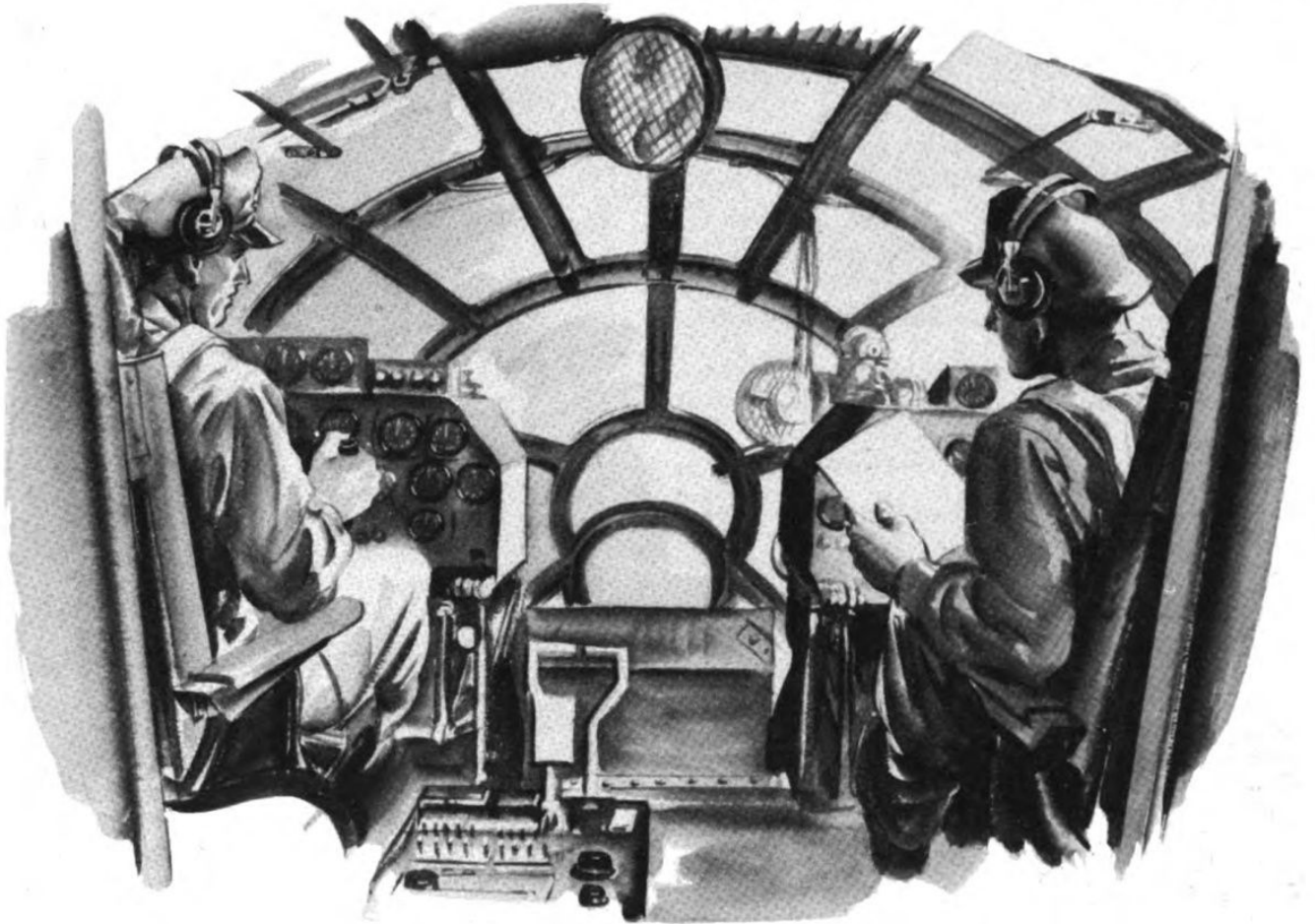

4. Landing Gear Down Lock and Bomb Bay Door Locks Removed

5. Parachutes Checked

Airplane commander and copilot put on parachutes at this time, and check for location of their seat-type dinghies if the airplane carries them.

6. Clothing Checked

Airplane commander and copilot check for proper clothing for mission to be performed. Adjust helmet, throat microphone, and attach oxygen mask to left side of helmet.

7. Life Preservers Checked

On all over-water flights, airplane commander and copilot check to see that their life vests are fitted with cartridges. Wear parachute harness over life vest.

8. Seats and Pedals Adjusted

9. Parking Brakes in Place and Chocks Set

Airplane commander depresses rudder pedals and pulls out the parking brake lever. He and the copilot look out the windows on their respective sides to see that chocks are in place.

10. Safety Belts Adjusted and Fastened

11. Emergency Landing Gear Door Release in Place

T-handle on airplane commander's control stand should be down and safetied with light wire. Pulling this handle releases the nacelle doors only. (Installed only in earlier series.)

12. Emergency Bomb Door Release in Place

T-handle on airplane commander's control stand should be down and safetied with light wire.

13. Emergency Cabin Pressure Release in Place

T-handle on airplane commander's control stand should be down and safetied with light wire.

14. Landing Gear Transfer Switch NORMAL

Airplane commander sees that switch (airplane commander's control stand) is in the NORMAL position. In this position, the main landing gear and nosewheel are operated by the landing gear switch on the aisle stand. When the landing gear transfer switch is in the EMERGENCY position, power from the engine-driven generators goes to the emergency bus and the emergency landing gear motors can be actuated by the emergency landing gear switches. (Installed in earlier series only.)

15. Overcontrol ENGAGED

Airplane commander sees that the lever on

airplane commander's control stand (eliminated in later series) is in the ENGAGED position (full forward). This engages the flight engineer's throttles.

16. Landing Gear Switch DOWN and Fuse Checked

Switch (airplane commander's aisle stand) should be down. Check to see that fuse in airplane commander's aisle stand is in place and not burned out.

17. Battery Switch ON

Copilot calls on interphone: "Battery switch." Flight engineer flips battery switch ON and notifies the copilot.

18. Hydraulic Pressure

The copilot asks the flight engineer to check the emergency hydraulic pressure on the engineer's panel (900-1075 psi). Copilot then checks the normal hydraulic pressure by depressing and releasing the brake pedals until the gage on his control stand indicates 800 ± 25 psi. The hydraulic pump should then cut in and build the pressure up to 1000 ± 25 psi.

19. Flight Controls Checked

Airplane commander pushes down locking lever located at forward end of airplane commander's aisle stand. This also unlocks the throttles, which are held in closed position by a lock bar when the control lock is on. This lock bar is linked to the control lock in such a way that strong forward pressure on the throttles forces the control lock off and eliminates the possibility of locked controls on takeoff. (Note: Make sure that the control lock lever is pushed all the way down and fixed securely in the unlocked position.) The copilot makes the control check. In making the check, the copilot announces over the interphone: "Copilot to gunners; stand by to check flight controls." He then pulls the control column back and says on interphone: "Check elevators." Left

gunner answers: "Left elevator up, sir." Right gunner answers: "Right elevator up, sir." The copilot then pushes the column forward and completes his check on the elevators. Ailerons and rudder are checked in the same manner.

20. Radios Checked

While the copilot is checking flight controls, the airplane commander turns on his radio and requests and receives taxi information. Copilot, after checking controls, turns on radio compass and checks for proper operation. He then turns radio compass off and stands by on the interphone so that he can be in continuous contact with the crew.

21. Altimeters Set

Airplane commander and copilot set their altimeters by the tower altimeter setting. Check the altitude reading against the known field elevation. If the altimeter setting given by the tower indicates an altitude different from the known field elevation, check the setting again and note the difference in elevation so you can use it in correcting the reading when landing.

22. Turrets Stowed

Airplane commander checks all turret warning lights on his instrument panel to see that all turrets are properly stowed. Turret lights should be out.

23. Lights Checked

If any night operation is contemplated on the flight, check all lights—fluorescent lights, identification lights, landing lights, and position lights (switches on control and aisle stands). A member of the ground crew should be instructed to check the landing lights and position lights. Wing position lights are not visible from the airplane in flight. They can be inspected at night from inside the airplane only by checking the reflection on the ground.

24. Oxygen——PSI

Airplane commander and copilot check their oxygen pressure gages and their walk-around bottles for proper pressure (400 to 425 psi). Auto mix should be on ON, emergency valve OFF.

25. Propellers High Rpm

The airplane commander pushes the propeller switches (on the aisle stand) to INCREASE RPM (forward) and holds them there until the propeller limit lights on copilot's instrument panel flash on. The propeller governors then will be in high rpm. (Note: Always grasp both gang plates when making propeller adjustments. This insures action of all four toggle switches and prevents any possibility of their sticking.)

26. Turbos Off

Airplane commander checks to see that the turbo selector dial is set at 0. Turbo-supercharger regulators are ready for instant operation at any time since amplifier tubes remain on even with selector dial at 0.

27. Flight Engineer's Report

The copilot calls on the interphone: "Engineer's report." The flight engineer responds: "Ready to start engines." (At this point, if the flight engineer has not completed his checklist, the airplane commander waits before giving the command to start engines.)

28. Stand Clear—Fire Guard—Clear Left—Clear Right

When ready to start the engines both the airplane commander and the copilot give the command "Stand clear" to the ground crew (clear right, clear left). When the fire guard is ready, copilot says on interphone: "Stand by to start engines."

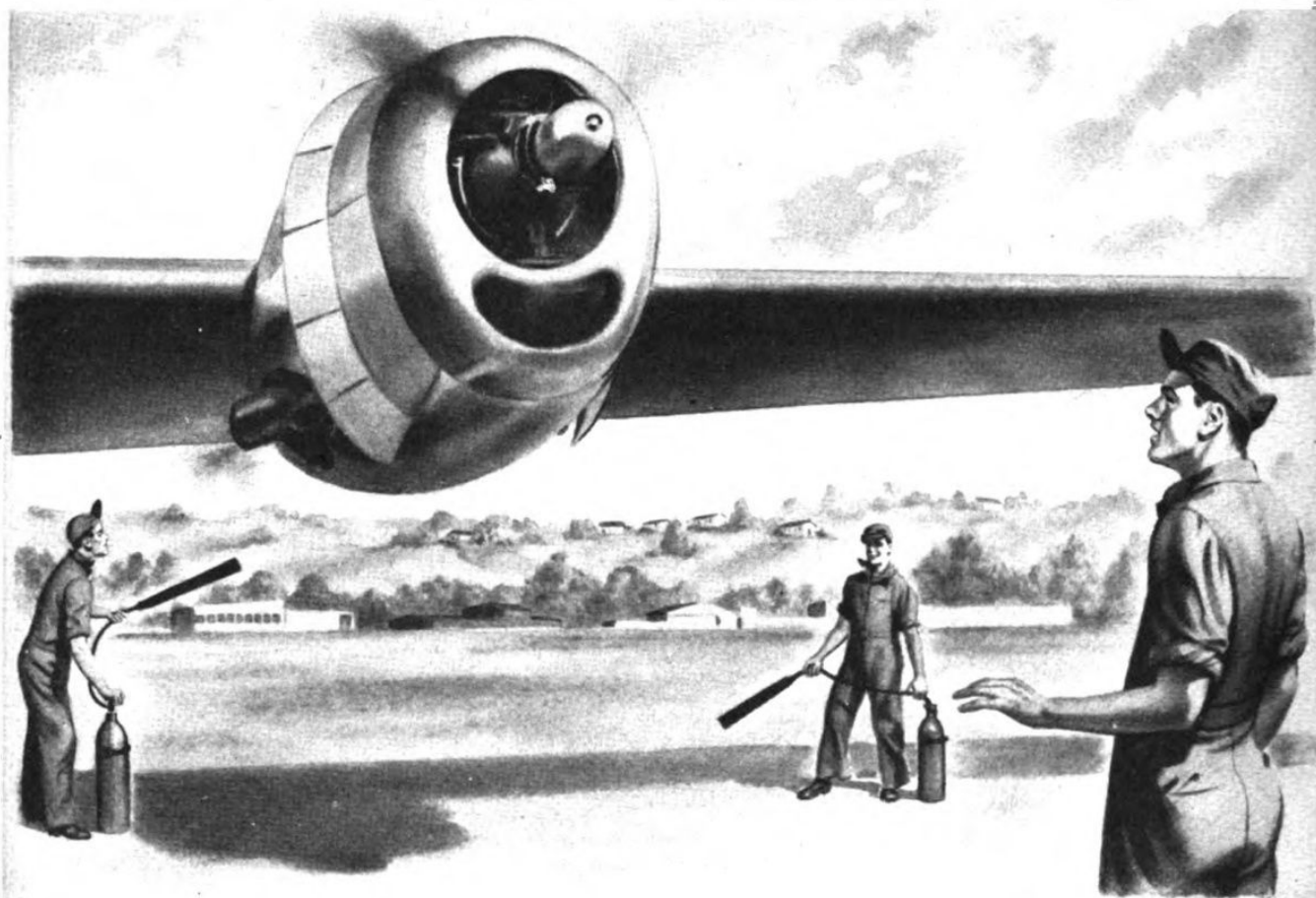

Starting the Engines

The engines are started in 1, 2, 3, 4 order. The airplane commander signifies to the ground crew that No. 1 engine is ready to be started, and then tells the flight engineer to start No. 1 engine. The number of fingers held up by the airplane commander and copilot indicates the number of the engine to be started.

When the engine starts, the flight engineer ordinarily reports: "Engine operating normally." Then he announces: "Ready to start No. 2 engine." Follow a similar procedure for the other engines.

The flight engineer handles the throttles

throughout the starting procedure, keeping the rpm between 1000 and 1200. When an engine is running smoothly, the flight engineer sets the throttle at 700-1000 (1000 rpm if oil temperature is below 40°C). Thereafter, the airplane commander will control the throttles except when asking for engine-driven generators and during the engine run-up. If any crew member sees that an engine is loading up (black smoke, or rpm drop, or both) he informs the copilot on interphone. In the event of engine fire, place jackbox in CALL position and make necessary report.

DO NOT IDLE ENGINES BELOW 700 RPM

STARTING DON'TS

1. Don't start the engines until the Before Starting Checklist has been covered item by item.



2. Don't start the engines until the propellers have been pulled through to eliminate any possibility of liquid locks.



3. Don't jam throttles forward at any time, especially during the starting procedure.

4. Don't start your engines until a fire guard is posted.



5. Don't continue to run an engine if the nose oil pressure and rear oil pressure do not build up within 30 seconds after starting.

Before Taxiing



1. Vacuum Checked

The copilot tells the flight engineer on interphone: "Check vacuum." The flight engineer, after checking the vacuum reading for both pumps (gauge on engineer's panel should read 3.8" to 4.2" Hg.), reports this check to the copilot on interphone.

If the vacuum selector valve is stopped between the two ON positions the light on the airplane commander's instrument panel will flash on.

2. Gyros Uncaged

Airplane commander and copilot check their gyro instruments to make sure that they are uncaged and operating correctly. At this time, set the directional gyros to agree with the magnetic compass reading.

3. Instruments Checked

Airplane commander and copilot check their respective instrument panels for proper readings and operation of all instruments.

On One Interphone Call Check }

- 4. Alarm Bell
- 5. Phone Call Signal Light
- 6. Combat Station Report

Airplane commander switches on alarm bell (aisle stand) and phone call signal light (aisle stand), then calls for combat station report. Copilot repeats this command on interphone saying, "**Combat station report,**" and receives acknowledgment in the following manner: bombardier, flight engineer, navigator, radio operator, top gunner, left gunner, right gunner, radar observer, and tail gunner (in that order) acknowledge that they have completed a check of their stations by saying, for example: "**Flight engineer O.K.**"; "**Alarm bell O.K., light O.K., top gunner O.K.**"; "**Left (or right) gunner O.K.**"; "**Light O.K. (radar compartment), tail gunner O.K.**"



7. Chocks Out

Airplane commander and copilot check to see that chocks have been pulled.

8. Bomb Bay Doors Closed

Copilot calls for bomb bay doors closed. Copilot says on interphone: "**Bomb bay doors closing.**" Flight engineer sets throttle on coolest engine to 1500 rpm and places generator on the line. The radio operator and one of the gunners check through the pressure doors and report to the copilot when the doors are closed. Flight engineer then returns throttles to 700 rpm and turns all generators off. (Generator

procedure is unnecessary with pneumatic bomb bay doors.)

When bomb bay doors are of the pneumatic type.

Radio operator and scanner open the bomb bay door safety shut-off valve, check the bomb bay safety switches for the "can salvo" (ON) position, and then report: "**Bomb bay doors closed, safety valves open.**"



9. Parking Brakes Off, Ready to Taxi

After releasing the parking brakes, the airplane commander gives the command: "**Parking brakes off, ready to taxi.**" The copilot repeats the command over the interphone.

10. Emergency Brakes Checked

After parking brakes are released, when starting to taxi, the copilot says: "**Emergency brakes.**" Airplane commander then pulls the emergency brake hand metering levers (aisle stand) to see that emergency brakes are operating properly on both sides. Copilot then tells flight engineer to recharge the emergency system. Normal brakes may be used safely while recharging the emergency system since the electric hydraulic pump recharges both systems with the hydraulic servicing valve on emergency.

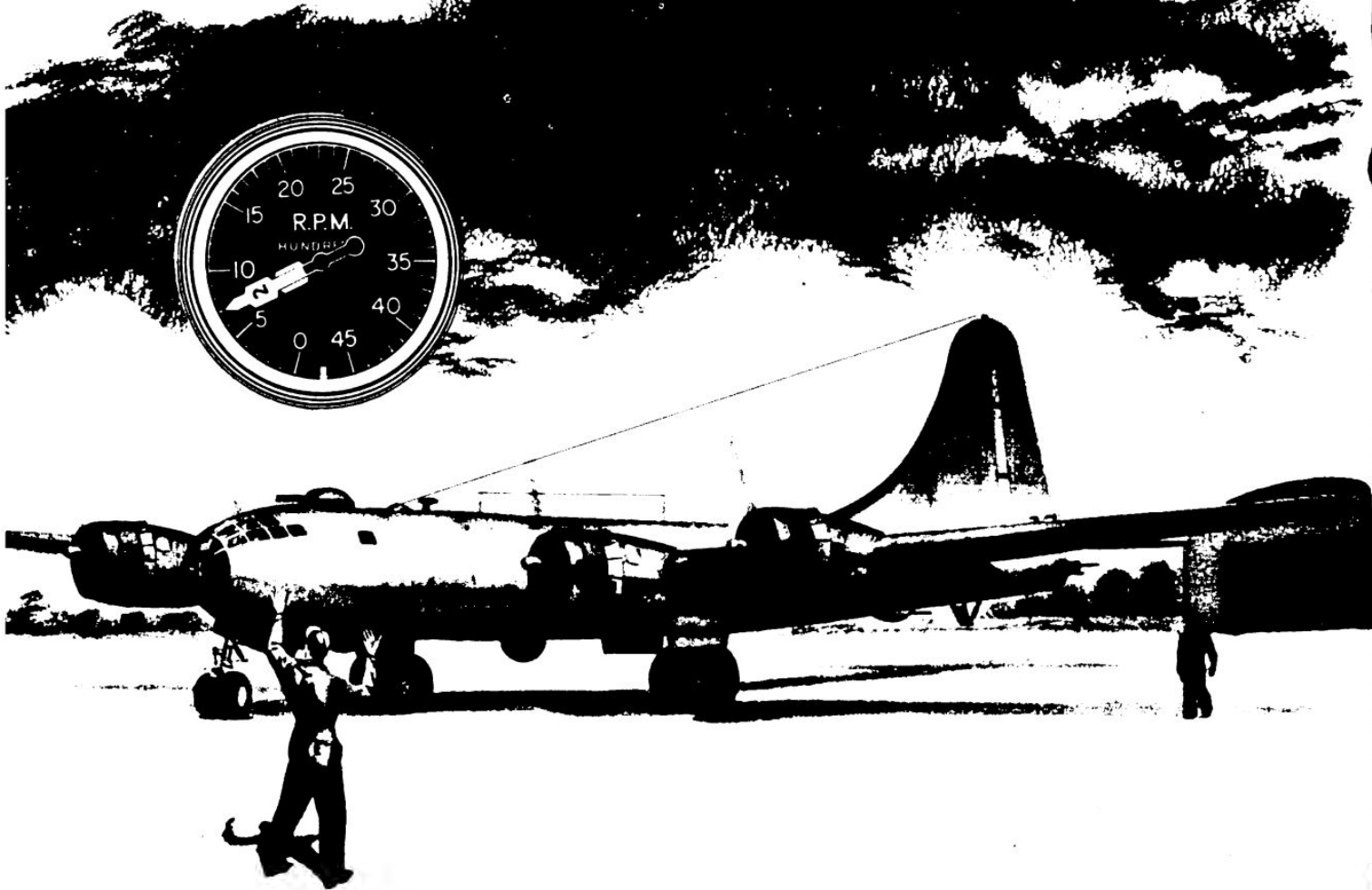

TAXIING PROCEDURE

Like all tricycle-landing-gear aircraft, the B-29 taxis easily. The brakes are good and have four expander tubes per wheel. Remember, however, that the B-29 is big and heavy. It gains momentum rapidly and, because of its size, you have to depend on your side and top gunners to act as observers to warn you of obstacles.

For all ground operations, set the props at 700-1000 rpm and the mixture in AUTO RICH. Never use AUTO LEAN for taxiing. If the carburetors are adjusted properly the engines idle as low as 550 rpm without loading up.

When taxiing uphill or in hot weather, 700 rpm may not keep the airplane rolling. Under these conditions, increase all throttle settings, but not more than necessary to continue taxiing. Always return throttles to 700 rpm when parked.

For maximum cooling and prevention of backfires, control both the speed and direction with brakes alone. Entering a taxi turn with outside throttle doesn't save your brakes, in the long run, because the speed of the airplane accelerates quickly with this extra power and you must use the brakes to slow down. If you gain too much speed, bring the airplane almost to a stop, straight ahead, then stay off the brakes as long as possible to let them cool.

*Don't Rely
on Brakes*

BEFORE TAKEOFF

1. Nosewheel Straight

Before engine run-up, copilot checks through cockpit floor observation window to make sure the nosewheel is straight.

2. Engine Run-up

The airplane commander gives the command: "**Stand by for engine run-up,**" and the copilot repeats the command over the interphone. The engine run-up for first takeoff should be accomplished in the following manner (for subsequent takeoffs items a. through g. may be eliminated):

a. Airplane commander increases all throttles to 1500 rpm and commands: "**Check generators.**" Copilot starts flaps down (switch on aisle stand) and tells flight engineer (on interphone) to check generators. Copilot holds switch DOWN until flaps have reached 25°, pauses for 10 seconds, and then brings flaps to full UP position.

Note: Flaps are run down at this time in order to have an electrical load on the normal bus so the flight engineer can properly check the generators. Gunners check the lowering of the flaps by reporting: "**Left flap down 25°,**" and "**Right flap down 25°.**"

b. Airplane commander operates all four propeller switches to full decrease then to full increase (from limit warning light to limit warning light) to test the propeller governors. At full decrease rpm, before returning switches to increase rpm, check tachometers for stable, uniform readings of 1200-1300 rpm. When propellers are again returned to high rpm, tachometers should all read 1500 as before. Any propeller overshooting the original setting is not being properly governed and this must be corrected before takeoff. (See section on **Curtiss Electric Propeller System** for engine run-up of airplanes equipped with these props.)

c. When propellers and generators are checked, airplane commander pulls No. 2, 3, and 4 throttles back to 700-1000 rpm and tells flight engineer to check magnetos.

d. Flight engineer advances No. 1 throttle to 2200 rpm, reports manifold pressure to copilot, checks magnetos, and calls out, "**Right, both, left, both.**" Flight engineer then returns throttle to 700 rpm. (If desired, a full-power, no-boost run-up may be made.) At sea level, approximately 32" is normal manifold pressure for 2200 rpm. Above sea level, subtract one inch for each thousand feet of altitude. Changes in temperature will vary these settings, but the variation will be the same for all engines. Excessive manifold pressure on one engine is an indication of a bad cylinder, a bad valve, or some other engine malfunction.

e. Magneto check is made for each engine. Allowable drop at 2200 rpm is 100.

f. If rpm drop on any engine is more than 100 (caused by fouled plugs) proceed with full-power check for that engine. Then check magnetos (turbos off) on bad engine again. If rpm drop is still above 100, return airplane to the line.

g. After magnetos are checked, airplane commander sets turbo selector to takeoff position and advances throttles one at a time full open to check manifold pressure and rpm. For this ground check gages should read between 2500 and 2600 rpm and 46½" and 47½" manifold pressure. Deduct ½" manifold pressure for each 50 rpm below maximum governed speed. (For certain types of engines, gages should read 2700-2800 rpm and 48"-49" Hg.)

WARNING

Do not check magnetos with turbos on. A backfire at this time (with turbos on) can damage turbo and waste gate assembly.

If possible head the airplane into the wind for maximum cooling during engine run-up.

RESTRICTED

3. Wing Flaps Set to 25°

Lower wing flaps to 25° and have gunners report: "Left flap down 25°," "Right flap down 25°."

4. Trim Tabs Neutral

The airplane commander checks to see that all trim tab controls are in the neutral position.

5. Autopilot OFF

The airplane commander makes sure that all autopilot switches (airplane commander's aisle stand) are off.

6. Windows and Hatches Closed

As the airplane commander closes and secures his window, the copilot closes his, checks to see that the forward compartment entrance hatch is closed, and checks over the interphone saying: "Close rear entrance door and escape hatch" to the tail gunner to make sure that the rear entrance door and rear escape hatch are closed.

7. Turbos Set for Takeoff

On most airplanes takeoff setting on TBS will be position No. 8. Some airplanes are

equipped with the Type B-7 control on the TBS to provide for water injection. On these airplanes the takeoff setting is marked at 3¾ on the TBS.

8. Propellers High RPM

The copilot pushes the propeller switches (on aisle stand) to INCREASE RPM (forward) and holds them there until propeller limit lights on his panel flash on.

9. Crew Ready for Takeoff

The copilot says on interphone: "Prepare for takeoff," then notifies the airplane commander.

10. Radio Call Completed

Airplane commander calls tower and requests permission to take off.

11. Throttle Brake Adjusted

Airplane commander adjusts his throttle brake for desired friction to prevent slipping.

12. Flight Controls Checked

Check controls for freedom of movement. Airplane commander, as he turns onto runway, notifies flight engineer:

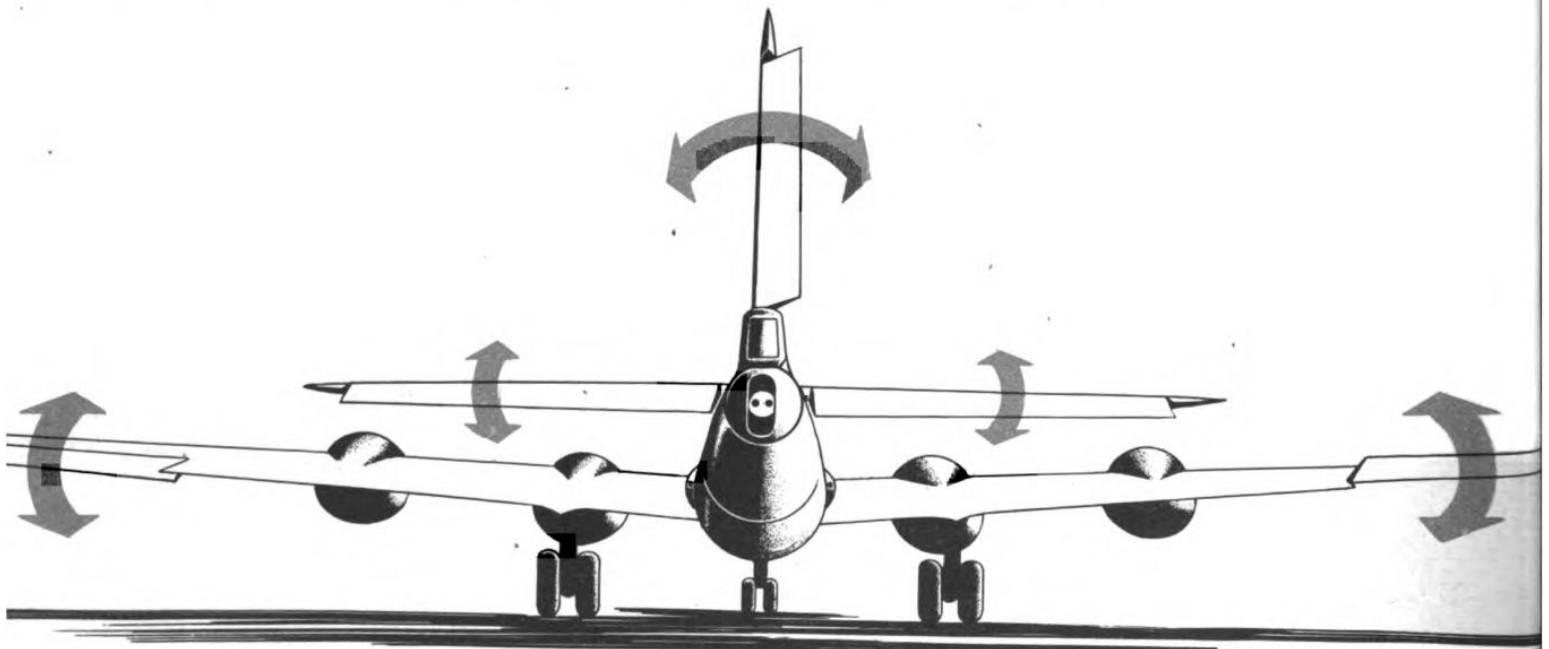

"Stand by for takeoff"

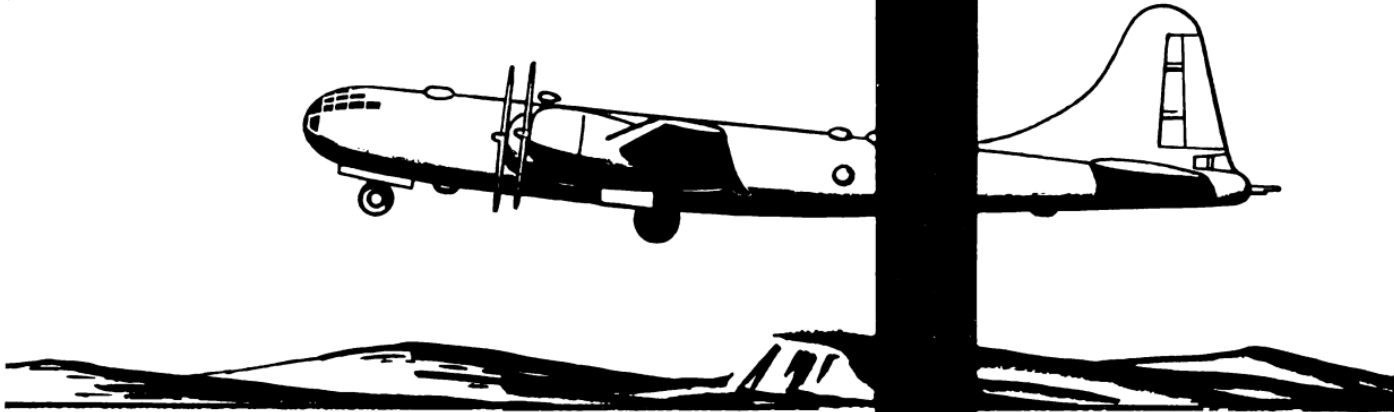

Keep the cylinder-head temperatures (CHT) at a minimum before takeoff. Never take off with any CHT above 220°C.

Use the minimum of brakes and throttles to line up on runway. Then, as the airplane starts to roll, advance the throttles slowly. The rudder begins to be effective at approximately 70 mph. In this way, you can maintain directional control first with throttles, then with rudder.

Don't use the brakes to hold the airplane straight on the runway, except in emergencies, since this increases the takeoff distance and wears out the brakes and tires. If you are careful not to use brakes, the airplane will gain speed continuously from the point of run-up to the point where the wheels leave the ground.

If you advance the throttles too quickly at the beginning of the roll, you won't have the reserve power necessary to hold the airplane straight with throttles and until the airplane picks up speed you may have to use brakes to stay on the runway. This increases the time required to get rudder control, and lengthens the takeoff roll.

The copilot follows through on throttles, making a continuous power check as the throttles are advanced during the initial takeoff roll. Full power should be obtained during the roll down the first third of the runway. If any unusual power conditions are noted, the copilot notifies the airplane commander, who still has time to cut throttles if he decides that takeoff is inadvisable.

RESTRICTED

39

LINE UP WITH RUNWAY



RESTRICTED

Never attempt takeoff with less than full takeoff power. Full-power takeoffs are not harmful to the engines as long as the CHT's stay within their limits. Takeoffs with reduced power prolong the time required to reach 195 mph—the minimum speed at which adequate engine cooling can be obtained during the initial climb.

When adjusting propeller rpm immediately after takeoff, **make sure that none of the propeller rpm switches sticks in the decrease rpm position. TO BE SURE, ALWAYS USE BOTH GANG PLATES WHEN OPERATING THE SWITCHES.**

At 90 mph, relieve pressure on the nosewheel oleo by easing the control column back. As soon as the ship is safely off, airplane commander brakes wheels and calls for gear up.

Note: Don't pull the nosewheel off the ground. Just relieve pressure so as to lengthen the oleo strut. For the ideal takeoff the nosewheel will not be more than one inch from the ground during any part of the takeoff roll. The airplane will become airborne in a good safe flight attitude which will facilitate a steady climb and a rapidly accelerating airspeed.

Power Condition Two

At a minimum of 140 IAS the airplane commander calls for Power Condition 2 (43½" and 2400).

At 150 mph, the airplane commander calls for flaps up easy. A recommended procedure is to have the copilot retract flaps to 10° at which time he notifies the airplane commander and then completes the retraction.

CAUTION: As the flaps come up to last 10° there is a noticeable change in lift and the airplane commander should be alert to compensate for this change in lift by back pressure on the control column. Gear and flaps pull a total of 965 amperes and may be safely raised together provided the switches are not tripped simultaneously.

Copilot receives reports from side gunners and tail gunner on operation of gear, flaps, and tailskid.

With gear and flaps full up, the airplane commander calls for power reduction. Reduce the

manifold pressure with the turbo selector dial until turbos are off, at which time copilot announces to flight engineer, "Turbos off." Make subsequent manifold pressure reductions with the throttles.

Cowl flaps, which are 15° open as the airplane takes the runway, are closed to 7½° or less (depending on cylinder-head temperatures) by the time the airplane leaves the ground. This setting permits rapid increase of airspeed and should keep all cylinder-head temperatures below 260°C.

If cylinder-head temperatures rise above 260°C on takeoff, or stay above 248°C after the second power reduction, the flight engineer informs the airplane commander. The airplane commander can then order cowl flaps on the hot engine opened to a maximum of 10°. (Never open cowl flaps more than 10° in flight. Larger openings provide little, if any, additional cooling and reduce cruising ranges considerably.) Or, the airplane commander can pull back the throttle on the hot engine to about 25". A slight reduction of manifold pressure is often sufficient to reduce cylinder-head temperature to within operating limits. The throttle should not be pulled back unless the airplane has reached 170 mph.

Cowl flaps should be set at the smallest opening which keeps cylinder-head temperatures below the required maximum (260° for takeoff, 248° for climb, 232° for cruising—continuous).

NOTE

On all takeoffs, first climb to 500 feet above the terrain with a minimum airspeed of 160 mph. Then, before continuing the climb, level off until reaching climbing airspeed (195 to 205, depending on weight) and until CHT's fall below 248°C.

TAKEOFF EMERGENCIES

Just remember these points if an engine fails on takeoff:

1. Get directional control first, using rudder and minimum aileron. Then pick up airspeed before trying to climb.

Because of the large flap area on the B-29, the total or partial loss of an engine on one side creates an unbalanced blast against the flaps which tends to raise one wing and lower the other. Ailerons may not be effective enough to counteract this tendency to roll unless power is balanced. However, if one engine has been retarded to balance power, restore power as soon as the airplane is under control.

2. Drag with gear and flaps down is excessive, so raise gear immediately and bring up flaps at 150 mph, even if gear is not all the way up.

3. If you use turbo position No. 10, reduce power as soon as possible.

4. Determine which engine has failed and whether it is delivering some power or should be feathered.

5. If two engines fail on takeoff, be prepared to crash-land straight ahead.

6. If possible avoid climbing below 170 mph.

Runaway Propeller

1. **Throttle back** to bring rpm and manifold pressure within limits: 2200 rpm and 35" Hg.

2. If throttle does not control rpm, use the feathering button intermittently. Feather propeller completely as soon as a safe altitude is reached.

Don't confuse normal overspeeding of the propellers up to 3150 rpm, caused by a power surge, with a runaway propeller. The governor

normally returns an overspeeding propeller to the set speed within a few seconds. Sometimes, after the feathering button has been used to return the propeller to normal rpm, the governor controls the propeller, if the airplane commander is careful not to apply sudden power to the engine. In this case, do not feather the propeller. Just handle the throttles carefully and come in for a landing as soon as possible.

If propeller continues to overspeed beyond 3150 rpm, **throttle back** to control rpm. **Do not try to control a runaway propeller by holding the propeller toggle switch in the decrease rpm position.**

Runaway Turbo

1. **Throttle back** to bring manifold pressure within limits.

2. Change amplifier (amplifiers mounted forward of navigator's seat).

Climb

If all cylinder-head temperatures run high during a sustained climb, hold the climbing power setting and level off until the cylinder-head temperatures return to normal, then start climbing again.

Climb at rated power, regardless of the gross weight. Rated-power climbs use less fuel, provided the cylinder-head temperatures can be maintained within limits during a sustained climb.

**UNDER NO CONDITIONS
ATTEMPT A TURN UNTIL YOU HAVE
DIRECTIONAL CONTROL AND A SAFE FLYING SPEED. IF
THERE IS NO ALTERNATIVE, CRASH-LAND STRAIGHT AHEAD.**

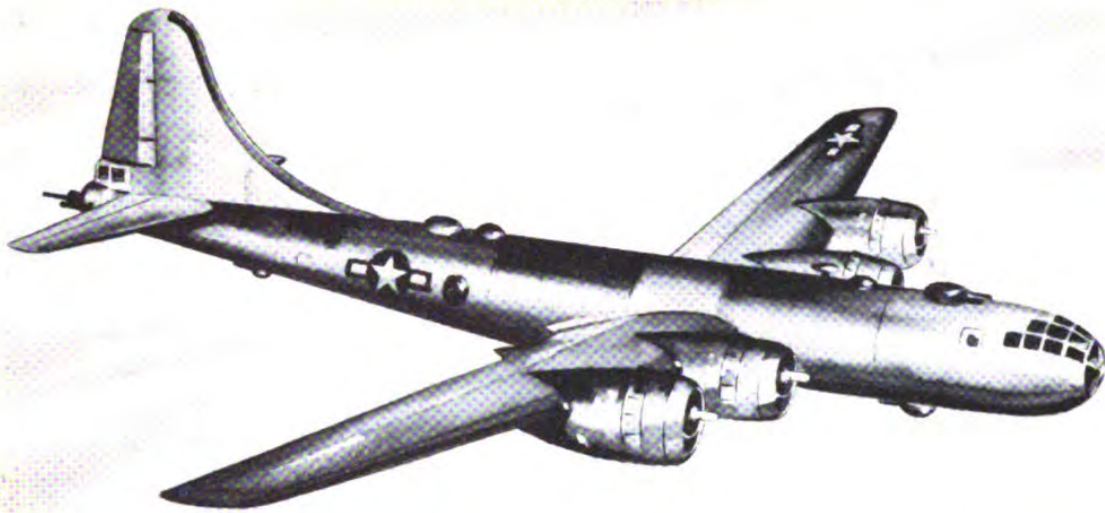

Cruising

Efficient cruising of the B-29 requires the maintenance of a constant recommended airspeed. The recommended airspeeds are obtained from the cruise control charts. Maintain the desired airspeed by use of the elevators and vary power settings slightly to maintain altitude. Do not allow the airspeed to drop; if you are unable to maintain altitude with given airspeed, add power as necessary.

In order to use minimum power for any given cruising speed, you must reduce the drag as much as possible. Use the smallest possible cowl flap and intercooler door openings which will keep cylinder-head temperatures at or below maximum and carburetor air temperatures within desired limits. Trim the airplane properly. Use related manifold pressures and rpm as given in the BMEP Power Schedule in Appendix I-A of AN 01-20EJA-1.

It is recommended that the following procedures be used in order to establish cruising conditions from climb.

1. If cylinder-head temperatures are not excessive level off at the desired altitude and continue to use rated power until desired airspeed is obtained. Hold the desired airspeed with the elevators and adjust power to maintain zero rate of climb.

2. If cylinder-head temperatures are excessive climb above the desired altitude and hold rated power at zero rate of climb until 210 mph CAS is obtained. Set predetermined cruising power setting, open cowl flaps to 10°, and descend to desired altitude at 210 mph CAS. Level off at desired altitude, close cowl flaps to predicted setting, and use elevators to hold desired cruising airspeed. Vary power settings slightly to maintain altitude. After desired airspeed has been established and cylinder-head temperatures have stabilized, cowl flaps may be opened or closed individually to maintain proper cylinder-head temperatures. This procedure is necessary only when excessive cylinder-head temperatures are encountered.

TRIMMING

Rudder

Hold wings level and center ball with rudder trim tab.

Ailerons

Hold wings level with ailerons and remove control pressure with aileron trim tab.

Elevators

Hold the desired airspeed with elevators and remove control pressure with elevator trim tab.

Note: If possible, make no turns with unbalanced power until after the airplane is trimmed for the condition. When using unbalanced power, make all speed and power changes smoothly and make appropriate change in trim immediately.

MAXIMUM ENDURANCE

The way to stay in the air the longest possible time is to fly the airplane at the speed where the engines use fuel at the lowest possible rate. That condition exists when you use the smallest amount of engine power to keep the airplane flying.

Actually the B-29 endurance speed is much higher than the B-17 long-range cruising speed. To get good performance, fly the airplane at a constant calibrated airspeed (CAS). This means that you must adjust the power to maintain altitude.

The less the airplane weighs and the lower the altitude flown, the longer the airplane stays in the air.

Note: For power settings, refer to the charts in Appendix I-A of AN 01-20EJA-1.

MAXIMUM RANGE

The B-29 is built to do one particular job well—to fly a long way with a big load of bombs. It has excellent abilities to fly fast and high, but its outstanding tactical ability is long-range bombing.

Maximum range is flown at the speed and altitude that give the greatest mileage from each gallon of gasoline consumed. This is a higher speed than that for maximum endurance. Adding a little more power to the minimum power needed to stay in the air (which also increases fuel flow) produces a fairly large increase in speed and therefore an increase in miles traveled for each gallon of fuel used.

If you fly the airplane at optimum speed, you obtain maximum range. A headwind decreases the range by its mph value for every hour the airplane flies. You obtain a greater range when flying at the given speed for the headwind. (This is true up to 75 mph headwinds.) The weight of the airplane and the altitude materially affect the speed.

When flying for maximum range, hold the recommended airspeed.

To obtain maximum range it is necessary to control the airplane's drag and weight. For each 6 lbs. added to the empty weight of the airplane, it is necessary to add one gallon of fuel to get the same range. This increases the gross weight 12 lbs. Every degree of cowl flap opening used above that required to cool the engines increases the fuel used by at least 15 gallons per hour. The airplane is clean and added drag affects it considerably. Everything added to the outside of the airplane, whether it is streamlined or not, adds drag and decreases the range and maximum speed.

If you have difficulty keeping up with the others, it is probably because of extra drag or extra weight.

To extend the maximum range, make descents at the recommended long-range cruising speeds and the lowest recommended power setting at the end of a long-range flight.

RESTRICTED

- ★ KEEP YOUR AIRPLANE CLEAN AND LIGHT.
- ★ KEEP THE COWL FLAPS AS NEARLY CLOSED AS POSSIBLE AND USE AUTO LEAN IF ENGINE POWERS AND CYLINDER-HEAD TEMPERATURES PERMIT.
- ★ USE RECOMMENDED AIRPLANE SPEEDS AND ENGINE POWERS.
- ★ ADJUST POWER TO MAINTAIN ALTITUDE.
- ★ MAINTAIN AIRSPEED WITH ELEVATORS.
- ★ REFER TO POWER SCHEDULE FOR RELATED POWER SETTINGS.

ENGINE MALFUNCTION IN FLIGHT

Low Nose or Rear Oil Pressure

When nose oil pressure drops below 20 psi, or when rear oil pressure drops below 50 psi, it is desirable to feather the propeller on that engine to prevent overspeeding and freezing of the engine bearing surfaces.

High Oil Temperature

If oil temperature goes above 90°C, throttle back and open oil cooler shutters manually to their limit.

If oil temperature goes above 100°C after the engine has been throttled back to less than 20" Hg and oil cooler doors have been opened, feather the propeller on that engine.

Engine Backfiring on Takeoff

If engine backfiring occurs during takeoff and sufficient runway is available for a landing, land the airplane and return to the line.

However, if you are already committed to the takeoff, throttle back the backfiring engine as much as is consistent with a safe takeoff. If the engine continues to backfire after throttle has been reduced, feather that engine as soon as safe altitude and airspeed have been reached.

Engine Backfiring During Cruise

If engine backfiring occurs during cruise, place mixture in AUTO RICH, and throttle

back to 20" Hg. if necessary. Increase throttle gradually. If backfiring recurs at normal cruise power settings, feather the propeller on that engine.

Remember: backfiring is to be expected when in AUTO LEAN at power conditions below 25" Hg and 2000 rpm. Place mixture in AUTO RICH when these power conditions are likely to occur.

High Cylinder-Head Temperature

To reduce high cylinder-head temperature in flight:

1. Open cowl flaps to not more than 10°.
2. Increase airspeed.
3. Place mixture controls in AUTO RICH.
4. Reduce manifold pressure.
5. Reduce carburetor air temperature.

It is advisable to reduce power on the particular engine as much as is consistent with safe airspeed.

High cylinder-head temperature may be caused by improperly installed orange peel cowling and cylinder baffles, improperly timed magnetos and ignition distributors, dirty cylinder cooling fins, and exhaust gases flashing over the thermocouple at the cylinder head.

Mission should be aborted if, after corrective measures have been attempted, cylinder-head temperature remains at or above 232°C at 70% power, or 248°C at 90% power.

Flight Characteristics



Even with its large size and weight, the B-29 has just about the same flying qualities as smaller aircraft. Large aircraft are usually slower in responding to the pilot's controls because of their greater inertia. But the control forces on the B-29 are light, and even at low flying speeds the combination of light forces with the high inertia of the airplane seldom gives the pilot any impression of sluggishness or lack of control. Just after taking off, and again during the short interval of time while landing, the rudder and the aileron control response is slow but it is still positive. The controls are as good and in many ways better than those of many small aircraft.

Elevators

The elevator control is almost exactly like that on the B-17. The size of the horizontal tail is the same except that the B-29 elevators have a little more balance and the nose of the tail airfoil section is turned up so that the tail does not stall when making a power-on approach to a landing with the flaps full down. Elevator trim tab is extremely sensitive in high-speed dives, and you must be careful not to over-control the airplane when flying with the trim tab.

Ailerons

The ailerons are large and have a full throw of 18° up or down, so that the pilot has good control. The control wheel travel is greater than that of the B-17. This extra control is valuable if an engine fails just after takeoff or when, for some reason, fuel is used on one side of the airplane only and the other wing gets heavy. The effect of unbalanced amounts of fuel in the two sides is noticeable in the aileron control when flying straight and level. If you allow the speed to approach stalling, the amount of aileron needed to offset uneven wing weights increases rapidly. Don't attempt a landing when this unevenness exists until you check the aileron control in flight at the landing speed.

The aileron trim tabs are geared to move when the ailerons move. The shape of the wing airfoil is such that the part covered by the ailerons has a hollow on top and is full on the bottom. If the control cables are out during combat, the ailerons would ordinarily trim down because of this shape. To avoid this, the trim tabs are rigged down $1\frac{1}{2}$ inches at the trailing edge to trim the ailerons more nearly neutral if a cable is cut or broken.

RESTRICTED

45

Rudder

The rudder gives the maximum possible control and stability, yet it can be moved without the help of power boosts. The diamond shape of the rudder is the result of studies made to find a rudder which behaves normally under all flight conditions. A good rudder is one that can be moved with a small amount of effort when an engine fails at any speed and does not become overbalanced or locked. Don't be confused by the light B-29 rudder forces—they do not tell you what the rudder is doing to the airplane. In landing approach conditions, it is possible to get an appreciable amount of skid with slight effort. Remember, it takes a certain amount of time to skid a large airplane and also to stop the skid.

Trim the rudder to center the ball.

Stability

The longitudinal stability of the B-29 is normal for all conditions. For good flying characteristics, however, the center of gravity (CG) must be kept within the allowable limits. The forward center of gravity limits are fixed by structural strength, and the elevator control for these forward limits is good for all normal operations. The most rearward center of gravity limit is determined by the longitudinal instability which occurs at climbing power. Going aft of this limit makes the airplane difficult to fly and decreases safety in flight.

Make every possible effort to keep the center of gravity within the design limits and to keep the gross weight of the airplane to the absolute minimum for the mission to be performed. Use a weight-and-balance slide rule before and during every flight.

STALLS

The stall characteristics of the B-29 airplane are entirely normal. In practicing the approach to the stall (complete stalls are not practiced) use not more than 15" Hg. As the airplane ap-



proaches the stall, a noticeable lightening of the elevator loads occurs. It is necessary to move the controls an appreciable amount to get a response from the airplane. Remember that in a stall you lose aileron control before you lose rudder and elevator control. Just before the full stall is reached, a shuddering and buffeting of the airplane occurs. The airplane recovers from the stall normally and has no excessive tendency to drop off on one wing when the stalls are properly controlled. Power reduces the stalling speed, but in general has no great effect upon the stall.

Never fly below the power-off stalling speed, since any loss in power when flying below this speed is likely to put the airplane into a violent stall. On all landing approaches, be extremely careful not to allow the speed to fall below the power-off stalling speed. Try power-off approaches whenever possible in order to become familiar with the airplane under emergency conditions. Never use power to reduce your landing speed.

When the airplane stalls, always recover by first nosing the airplane down and then increasing the power. Never apply power in the stall without first dropping the nose. In most aircraft, it is possible to obtain a high rate of descent by applying power during the power-off stall without dropping the nose. Avoid these conditions in the B-29.

POWER-OFF STALLING SPEEDS

INDICATED STALLING SPEEDS

Gross Weight	Flaps Up	Flaps 25°	Flaps Full
140,000 pounds	145 mph	131 mph	119 mph
130,000	140	125	114
120,000	135	121	110
110,000	129	115	105
100,000	123	110	100
90,000	117	104	95
80,000	110	98	89
70,000	103	92	84

Warning: Do not practice the approach to the stall with the cowl flaps open more than 10°

URNS

In spite of its size and weight, the B-29 has good maneuverability. It controls easily and turns easily:

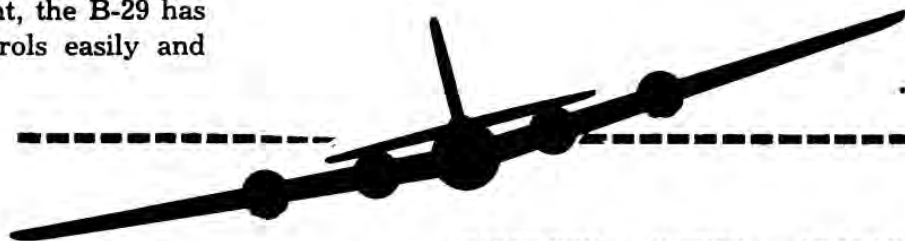

SHALLOW TURN . . . 1/2 NEEDLE . . . 12° TO 15°

STEEP TURN . . . FULL NEEDLE . . . 15° TO 30°

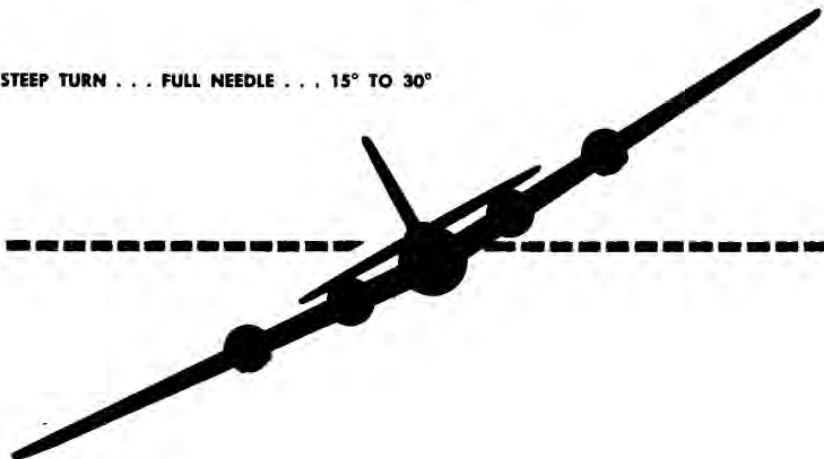

RESTRICTED

DIVES

The B-29 is limited in its allowable diving speed by both strength limitations and control characteristics. Again, remember that this is a big, heavy airplane. As the speed increases, the loads carried by nearly every part of the airplane increase rapidly. This is especially true of the horizontal tail surfaces.

The maximum diving speed at any time or any altitude is 300 mph IAS. This speed is sufficiently above the level-flight top speed of the airplane to cover most diving needs.



MAXIMUM DIVING SPEED 300 MPH IAS

DEAD-ENGINE CHARACTERISTICS

In straight and level flight, normal power, with one engine feathered and power balanced, the flight characteristics of the B-29 differ little from those of normal 4-engine operation. When turning into a dead engine maintain a speed of at least 160 mph IAS.

If two engines on the same side are out, the airplane has a tendency to roll and yaw. To keep lateral trim, apply rudder first and then aileron as needed. If turns are made into two dead engines, maintain a minimum airspeed of

160 mph indicated. At low weights it is possible to fly with two dead engines with good control at speeds down to 150 mph. However, at slower speeds full rudder is necessary to control the crab. In general, always stay at least 10 mph indicated above the power-off stalling speed. Keep the drag of the airplane as small as possible. At 100,000 lbs. gross weight it is just possible to maintain level flight on two engines with two propellers feathered and with the landing gear down and 25° flaps.

★ **Avoid making steep turns**

★ **Trim the airplane**

PROHIBITED MANEUVERS

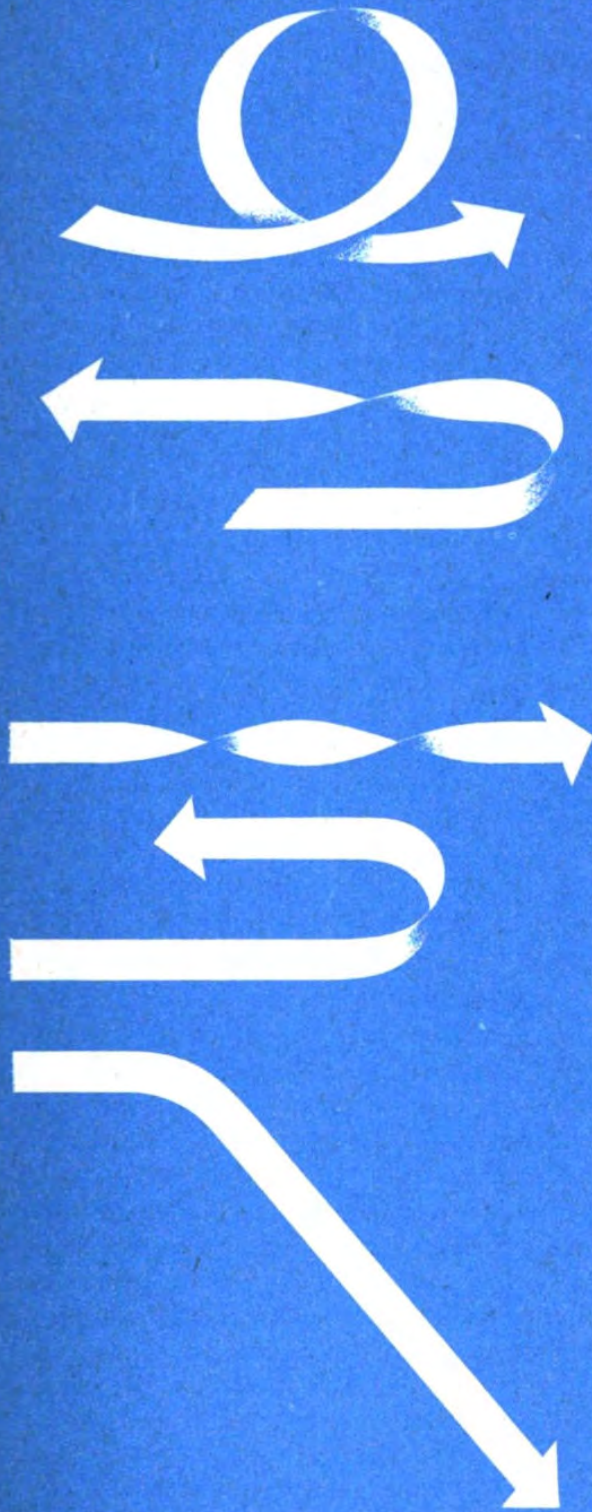

RESTRICTED

LOOP

SPIN

IMMELMANN

INVERTED FLIGHT

ROLL

VERTICAL BANK

DIVE

(IN EXCESS OF RED-LINE SPEED)

Don't fly the airplane with the center of gravity (CG) aft of 34% of the mean aerodynamic chord (MAC) at any time, and don't fly with it ahead of 24% except at low gross weights (120,000 lbs.).



Before Landing

1. Notify Crew—Prepare For Landing

The before-landing check starts on aircraft returning from a mission about 8 to 10 minutes before landing. For transition missions, take-offs can be spaced 10 minutes apart so that the airplane will not have to leave the traffic pattern. The airplane commander announces: "Prepare for landing." Copilot repeats the command over the interphone: "Prepare for landing," at which time the flight engineer orders the tail gunner to start the putt-putt. Crew members acknowledge in the following order: bombardier, flight engineer, navigator, radio operator, top gunner, left gunner, right gunner, radar observer, and tail gunner.

2. Radio Call Completed

The airplane commander calls the tower for landing information.

3. Altimeters Set

Airplane commander and copilot set their altimeters to the altimeter setting given by the tower.

4. Autopilot OFF

Airplane commander sees that all switches for the autopilot (on aisle stand) are off.

5. Turrets Stowed

Airplane commander checks to see that the turret warning lights on his instrument panel are out.

6. Hydraulic Pressure—PSI

The copilot checks to see that pressure is 1000 psi. Any difference in final pressure should be reported to the flight engineer. Copilot asks flight engineer to check emergency hydraulic pressure.

7. Propellers 2400 RPM

The copilot adjust propellers to 2400 rpm at airplane commander's request.

8. Landing Gear Down, Green Lights On

The copilot, on command of the airplane commander, lowers the landing gear and says over the interphone: "Gear is coming down." The side gunners check the main gear and announce in order: "Left gear coming down, sir," and "Right gear coming down, sir." When the gear is completely down the gunners announce again: "Left gear is down and locked," and "Right gear is down and locked." (For all night operation the gunners will use the Aldis lamp for checking the gear down.) The copilot checks the nosewheel through the observation window in the floor of the cockpit and checks the landing gear warning lights on his instrument panel. After receiving copilot's report that gear is down, airplane commander will check to see that the red light is off, and the three green lights are on.

The gear switch will be left in DOWN position until airplane is parked.

Note: The indicated airspeed must be less than 180 mph before the gear is lowered.

Visual check by the gunners and the copilot is most important. The red warning light and the green down and locked lights (and the landing gear warning horn, on some series) all operate from the gear motor limit switches. Remember this—the lights and the horn are **not** position indicators except in late series airplanes. They mean only that the limit switches have stopped the operation of the gear motors. If the switches open the circuit too soon, the gear will be only partially down and warning of this danger can come only from the visual check. The gear will support the weight of the airplane if the retracting screw is not more than 4 inches from the full down position (the screw itself retracts as the gear lowers). The

gear is not designed to support the airplane if the screw is extended more than 4 inches.

Have the putt-putt operator report when the tailskid is down.

9. Flight Engineer's Report

The copilot, on the interphone, calls for "Engineer's report." The flight engineer reports: "Gross weight ... lbs.; putt-putt on the line; ready to land."

10. Stalling Speed

The copilot finds the stalling speed based on the weight by referring to the table mounted on his instrument panel and informs the airplane commander.

11. Wing Flaps

At the airplane commander's order, the co-

pilot extends the wing flaps 25° just before turning into the base leg. Later, on the final approach and at the airplane commander's order, he extends full flaps, at which point the airplane commander retrimms the elevators. The side gunners check position of flaps and inform the copilot over the interphone. **Don't lower flaps above 180 mph indicated.** (Note yellow line on airspeed indicator.)

12. Turbos Set

Airplane commander calls for turbos on base leg. Copilot announces: "Turbos on" to flight engineer and turns selector dial to 8. (Some airplanes are equipped with Type B-7 control for TBS to provide for water injection. On these airplanes the takeoff setting is marked at 3¾ on the TBS.)

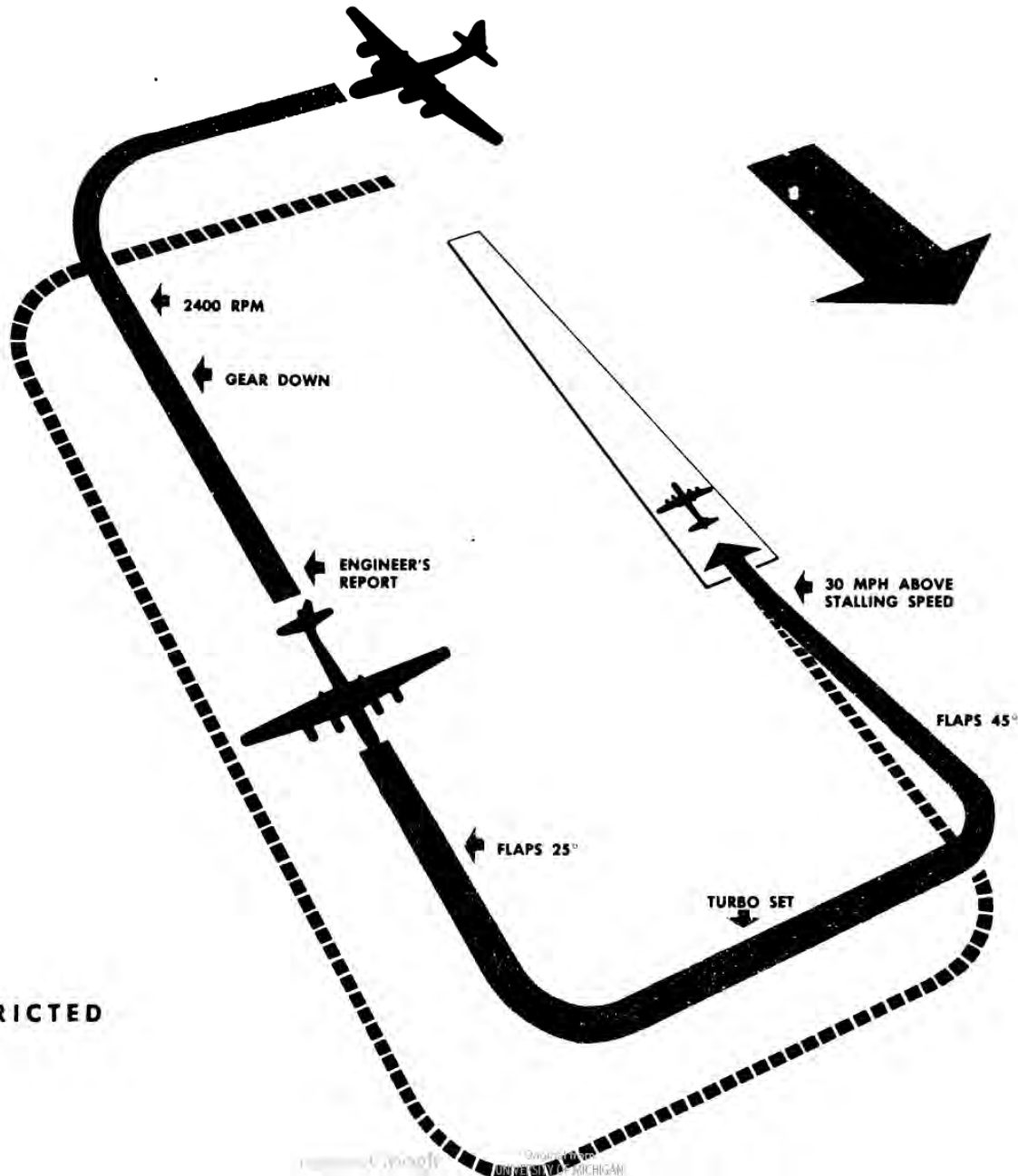

Landing Procedure



Don't put down full flaps until you are lined up with runway and sure of making the field. Go-arounds are difficult only when full flaps are down. After putting down full flaps, maintain an airspeed of 30 mph, indicated, above the power-off stalling speed. Don't chop the power at any point on the approach. Long approaches are unnecessary, even for narrow runways.

Crosswind Landings

When turning on the approach in a crosswind, be careful not to allow the wind to force you off your approach to a degree where it is impossible to align with the runway.

There are three possible ways of making a crosswind approach and landing: (1) holding the airplane straight toward the runway, dropping one wing into the wind with just enough

top rudder to counteract drift; (2) heading the airplane into the wind (crabbing) just enough to keep a straight ground path; and (3) a combination of the first two methods.

The combination of methods is preferred, because it eliminates the possibility of dropping the wing too low, or of crabbing too much, and decreases the amount of correction needed to straighten out and level off during the round-out.

Landing Roll

Don't use your brakes more than necessary after the wheels touch the ground. On a long runway, let the airplane roll until it loses speed. Lower the nose gently at 90 mph, and when nearing end of the roll, apply brakes evenly and smoothly.

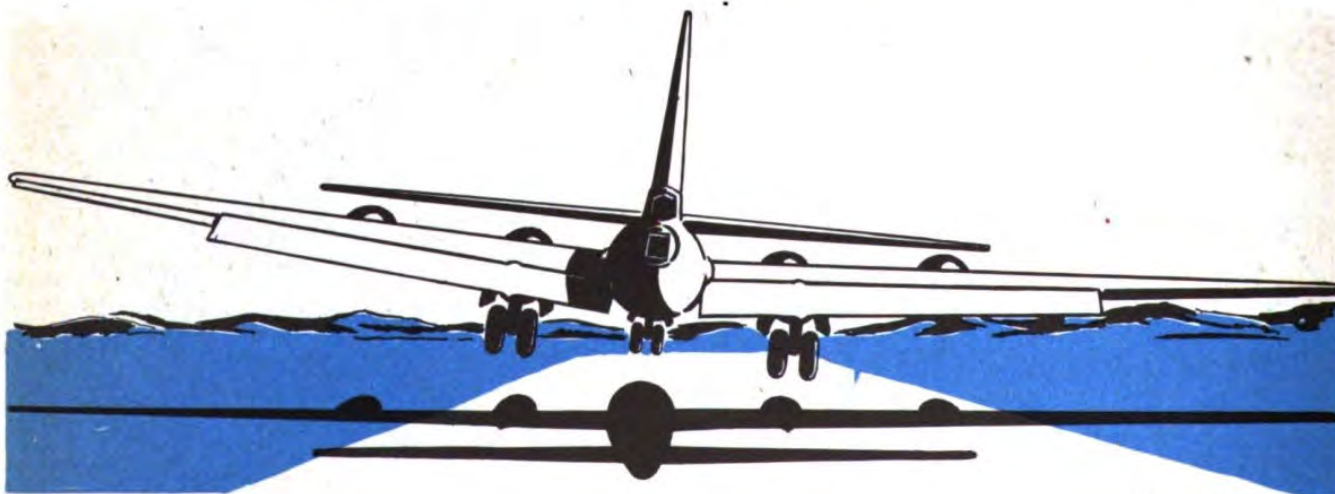

AFTER LANDING

1. Hydraulic Pressure OK

Copilot checks normal pressure gage for reading between 800 and 1000 psi.

2. Turbos Off

Toward the end of the landing roll, copilot turns TBS to 0.

3. Propellers in High RPM

Copilot checks to see that propellers are in high rpm position.

4. Wing Flaps Up

At the airplane commander's command, near the end of the landing roll, copilot raises flaps (all the way, if this is the last landing; to 25° if planning to make another takeoff). Side gunners report on position of wing flaps.

At night, after turning off the runway, stop the airplane, and run up the coolest engine to supply power to raise flaps. The power available from the putt-putt is not sufficient to carry the load of the landing lights, radio, and wing flaps.

5. Parking Brakes Set

6. Bomb Bay Doors Open

Copilot calls for bomb bay doors open. Copilot says on interphone: "**Bomb bay doors opening.**" Flight engineer sets throttle on coolest engine to 1500 rpm. The radio operator and one of the gunners check through the pressure doors and report to copilot that doors are open. Flight engineer then returns throttle to 700 rpm and turns all generators off. (Generator procedure unnecessary with pneumatic bomb

bay doors.) Radio operator and scanner will close the bomb bay door safety shut-off valve, check bomb bay safety switches for the "can't salvo" (OFF) position and then report: "**Bomb bay doors open, safety valve closed.**"

7. Engines Run-up and Cut

The airplane commander says: "**Run-up and cut engines.**" The copilot repeats the command on interphone. The flight engineer follows the procedure outlined in his checklist and reports to copilot when it is completed.

8. Radios Off

The airplane commander turns off the command set and the copilot switches off the radio compass.

9. Controls Locked

The airplane commander pulls the lock handle on the aisle stand to the up position and sees that the flight controls are securely locked.

10. Wheel Chocks in Place

Airplane commander and copilot see that chocks are in place.

11. Brakes Off

12. Forms 1 and 1A Accomplished

The flight engineer completes Forms 1 and 1A and presents them to the airplane commander for check.

13. Crew Inspection

Crew members leave the airplane and line up as before flight to be checked by the airplane commander. At this time, defects in the airplane not already noted are reported to the flight engineer.

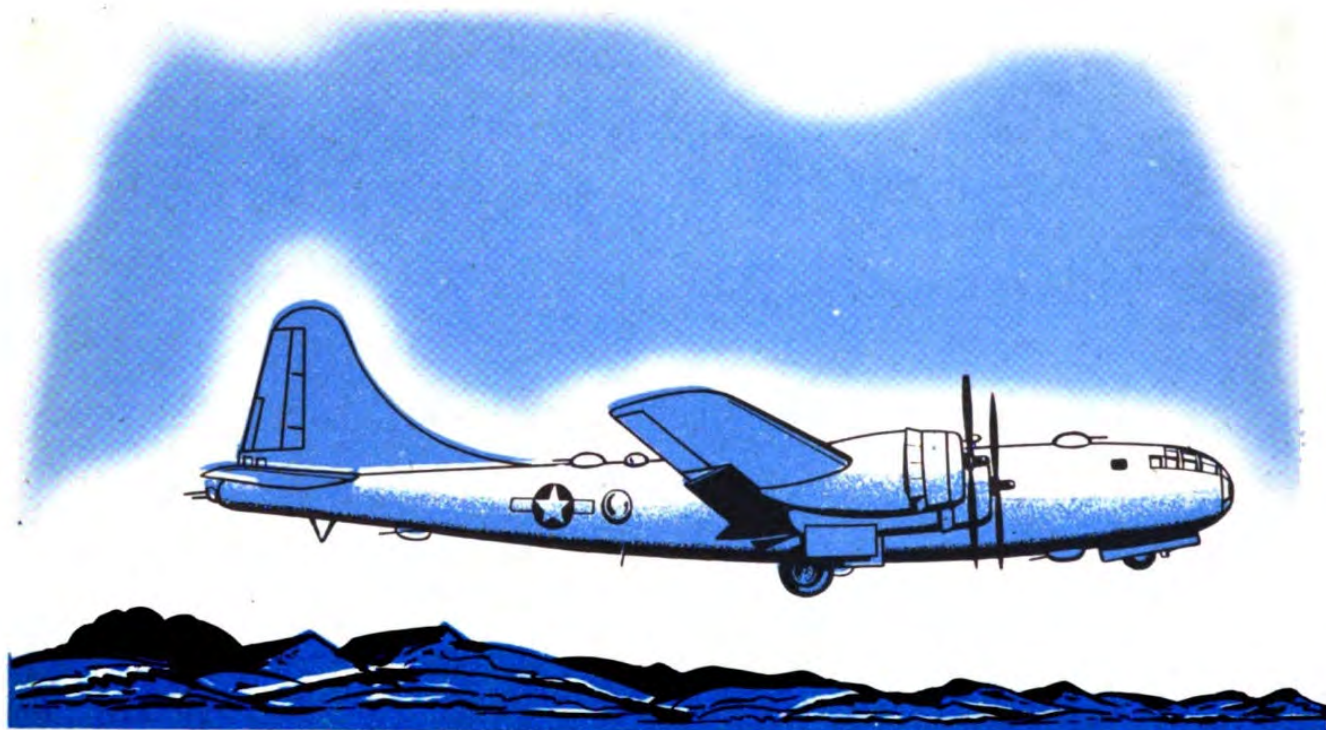

GO-AROUND

The procedure for a normal go-around is not complicated. Raise the flaps from the full-down position to 25° as power is applied and continue on the same approach angle until safe flying speed is reached. Then raise the gear as soon as you are sure that the runway will not be touched, and start the climb. Raising the flaps all in one movement to 25° is important. Don't wait for a safe flying speed—with flaps full down, you cannot attain a safe flying speed because of the high full-flap drag and reduced acceleration. Follow this procedure:

1. Notify flight engineer that you are going around.
2. Apply throttle gradually as needed.
3. Raise flaps to 25°.
4. Set full high rpm.
5. Don't try to climb until you reach a safe flying speed.
6. Raise gear when safely clear of the ground.
7. Proceed as in a normal takeoff.
8. If needed apply emergency power by advancing the TBS to emergency power marking.

GO-AROUNDS WITH LESS THAN FOUR ENGINES OPERATING ARE NOT RECOMMENDED

EMERGENCY LANDINGS

Wheels Up

The B-29 can be crash-landed with a minimum of injury to the crew. Whenever possible land on a hard surface in preference to sod or dirt. Do not feather props unless engine trouble requires feathering.

With wheels up, drag is reduced considerably, so plan your approach to land short. **Land the B-29 with as many wheels extended as possible unless only the nose gear will go down.** The damage sustained on a crash landing is greatly minimized if any of the main gear are down. If only the nose gear will go down, land the airplane wheels up, as the fuselage will probably buckle from the weight of the wing and engines. However, remember, in an emergency, extend any of the main gear that will go down. **Note:** Terrain conditions in the theater of operations may dictate variations of this procedure.

When you are positive that an emergency landing is inevitable, contact the control tower and continue to circle the field until the immediate area is cleared of all other traffic, and an ambulance, crash truck, and fire truck are ready on the flying line. If feasible, circle until the remaining fuel supply is 200 gallons per engine. If it is found inadvisable to land at your home base, proceed to the prescribed alternate and observe the same precautions.

It is the prerogative of airplane commanders to allow any crew member not essential to the emergency landing operation to jump from a safe altitude over the airport if he desires. If the crew member decides to stay with the airplane, he must prepare for a crash landing and then take up his prescribed crash-landing position. Crew members should stay clear of the lower turret areas and nose gear door because the turrets may tear loose and be forced up into the cabin. To prepare for the crash landing,



RESTRICTED

drop all bombs, auxiliary bomb bay tanks, and flares; open all emergency hatches except the bomb bay doors; and if time permits drain oxygen system. Proceed in the following order:

1. Close the nacelle wheel well doors of any retracted gear, if possible.
2. Make a normal approach sufficiently far back from the field and high enough to allow remaining crew members to perform the following last-minute preparations at the command of the airplane commander.
3. Lower full flaps for landing.
4. See that flight engineer is ready to set engine nacelle fire extinguisher selector.
5. Stop putt-putt.
6. Shut off fuel boost.
7. Close fuel shut-off valves on final approach when certain of making the field. (Approximately 10 to 15 seconds of fuel, at low power, remain in the lines after closing the fuel shut-off valves.)
8. Just before contact with the ground, throttle the engines back and place mixture control in FUEL CUT-OFF, when committed to land.
9. Turn the master ignition switch off, then turn the individual ignition switches and battery switch off.
10. Warn the crew members just before ground contact, then land by sliding airplane in on its belly.

Both Main Gear Down, Nosewheel Partially or Completely Up

1. Check with the operations control tower and stand by in the air until an ambulance, crash, and fire truck are ready on the flying line. If it is found inadvisable to land on the home base, proceed to alternate base directed and observe the same precautions.
2. Check with the operations control tower to be sure all air traffic is clear of the proposed landing zone.

3. Drop all bombs or auxiliary bomb bay fuel tanks and flares in a safe zone; if time permits drain oxygen system.

4. Allow all crew members not essential to the landing operation, who wish it, to jump from a safe altitude over the field. Otherwise, they are to help prepare for a crash landing and take their positions.

5. Open all emergency escape hatches to avoid jamming, with the exception of the bomb bay doors and the nose gear hatch. If the nose gear hatch is open and the nose wheel collapses, gears or parts of gear may be forced through hatch.

6. Shift disposable load and crew, if necessary, to the after compartments to shift the CG as far back as possible.

7. Make a normal approach to land on runway with full flaps.

8. See that the flight engineer is ready to set engine nacelle fire extinguisher selector.

9. Stop putt-putt.

10. Shut off fuel boost.

11. Close fuel shut-off valves on final approach, when certain of making the runway, and just prior to throttling engines for landing. Approximately 10 to 15 seconds of fuel, at a low power setting, remain in the fuel lines and carburetor after shutting off these valves.

12. Just before contact, throttle the engines and place the mixture controls in FUEL CUT-OFF position.

13. Turn master ignition switch off, then turn individual ignition switches and battery switch off.

14. After the main wheels touch the ground, hold the nose of the airplane in the air as long as possible with the elevators and then lower it gently until it strikes the runway.

15. After the nose of the airplane strikes the runway, apply brakes as necessary to bring airplane to a stop.

HOLD NOSE UP AS LONG AS POSSIBLE...THEN LET IT DOWN GENTLY AND APPLY BRAKES



One Main Wheel Up, Nosewheel and One Main Wheel Down

1. Check with the control tower and stand by in the air until an ambulance, crash truck and fire truck are ready on the flying line. If it is not advisable to land on the home base, proceed to the alternate base directed and observe the same precautions.

2. Check with control tower to be sure all air traffic is clear of the proposed landing zone.

3. Drop all bombs or auxiliary bomb bay fuel tanks and flares in a safe zone; if time permits drain oxygen system.

4. Allow all crew members not essential to the landing operation, who wish it, to jump from a safe altitude over the field. Otherwise, they are to help prepare for a crash landing and take their positions.

5. Open all emergency escape hatches to avoid their jamming, with the exception of the bomb bay doors.

6. Make a normal approach to land on runway.

7. See that the flight engineer is ready to set engine nacelle fire extinguisher selector.

8. Stop putt-putt.

9. Shut off fuel boost.

10. Close fuel shut-off valves on final ap-

proach, when certain of making the field, and just before throttling engines for landing. (Approximately 10 to 15 seconds of fuel, at a low power setting, remain in fuel lines and carburetor after shutting off these valves.)

11. Just before contact, throttle the engines and place the mixture controls in FUEL CUT-OFF position.

12. Turn master ignition switch off, then turn individual ignition switches and battery switch off.

13. With full flaps, make normal landing on good wheel with the wingtip slightly low on the good-wheel side.

14. Hold the wing on bad-wheel side up as long as possible with ailerons.

15. Be prepared for groundloop in the direction of the crippled wheel when wingtip and nacelle dig into runway. Use brakes to minimize groundloop.

One Main Wheel Down, Nosewheel and One Main Wheel Up

Follow the foregoing procedure up to and including item No. 11, then continue as follows:

12. With full flaps, make landing on the good wheel.

13. Hold nose of the airplane up and hold up the wingtip on the damaged main wheel side with elevator and aileron as long as possible.



LANDING WITH LESS THAN FOUR ENGINES

Three-engine Landing

With one engine dead and the propeller feathered, the B-29 can be flown without difficulty. A three-engine landing can be accomplished easily if you **plan your actions and follow the correct procedures.**

Remember these points:

1. Notify the control tower of your position and difficulty so that crash equipment can be alerted and the traffic pattern cleared.

2. Turns can be made into the dead engine if you **maintain airspeed and keep the airplane trimmed properly.**

3. Make your traffic pattern as nearly normal as is practicable, conserving altitude for a high final approach.

4. Don't lower the landing gear too soon, or it will be necessary to draw more power from the three operating engines.

5. Partial flaps may be lowered, but wait until you are sure of making the field before putting down full flaps.

6. Remember that the airplane has been trimmed to offset the loss of power of one engine, and be ready to correct for the "off trim" (i.e., trim to neutral) when the throttles are retarded for landing. A feathered propeller creates less drag than a propeller on an idling engine. Thus, in addition to the trim, you must

compensate for this off-balance condition.

Two-engine Landing

When contemplating a two-engine landing, bear in mind all the points mentioned above. But remember also that the necessity for smooth, well-coordinated turns and flying is even greater than in three-engine operation.

The necessary trim change will be greater if power is not balanced. (Not much trim change will be necessary if two outboards or two inboards are dead. If the remaining power is to be delivered by an outboard on one side and an inboard on the other, however, the trim required will be substantially greater.)

Be prepared for the change in trim necessary when power is reduced for landing.

With two engines dead, and their propellers feathered, you will float farther than with all four engines operating because the two feathered propellers create less drag.

Remember: Go-arounds are impossible with two engines out and gear and flaps down.

Single-engine Landing

At gross weights of 110,000 lbs. and less, and with three engines dead and their propellers feathered, it is possible to maintain a descent of 500 feet per minute at 170 mph IAS and rated power.

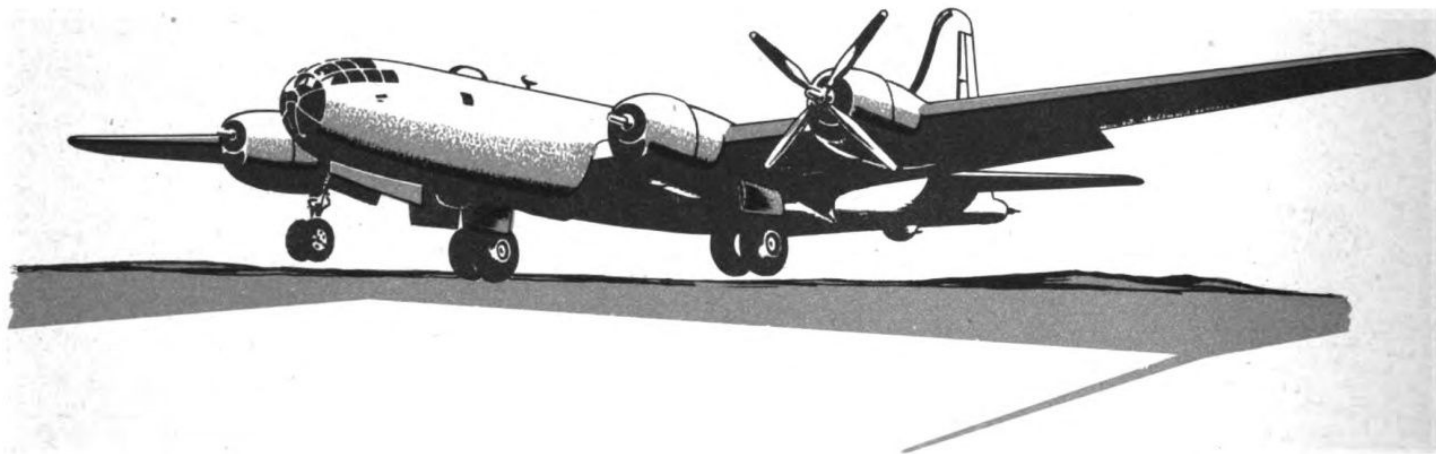

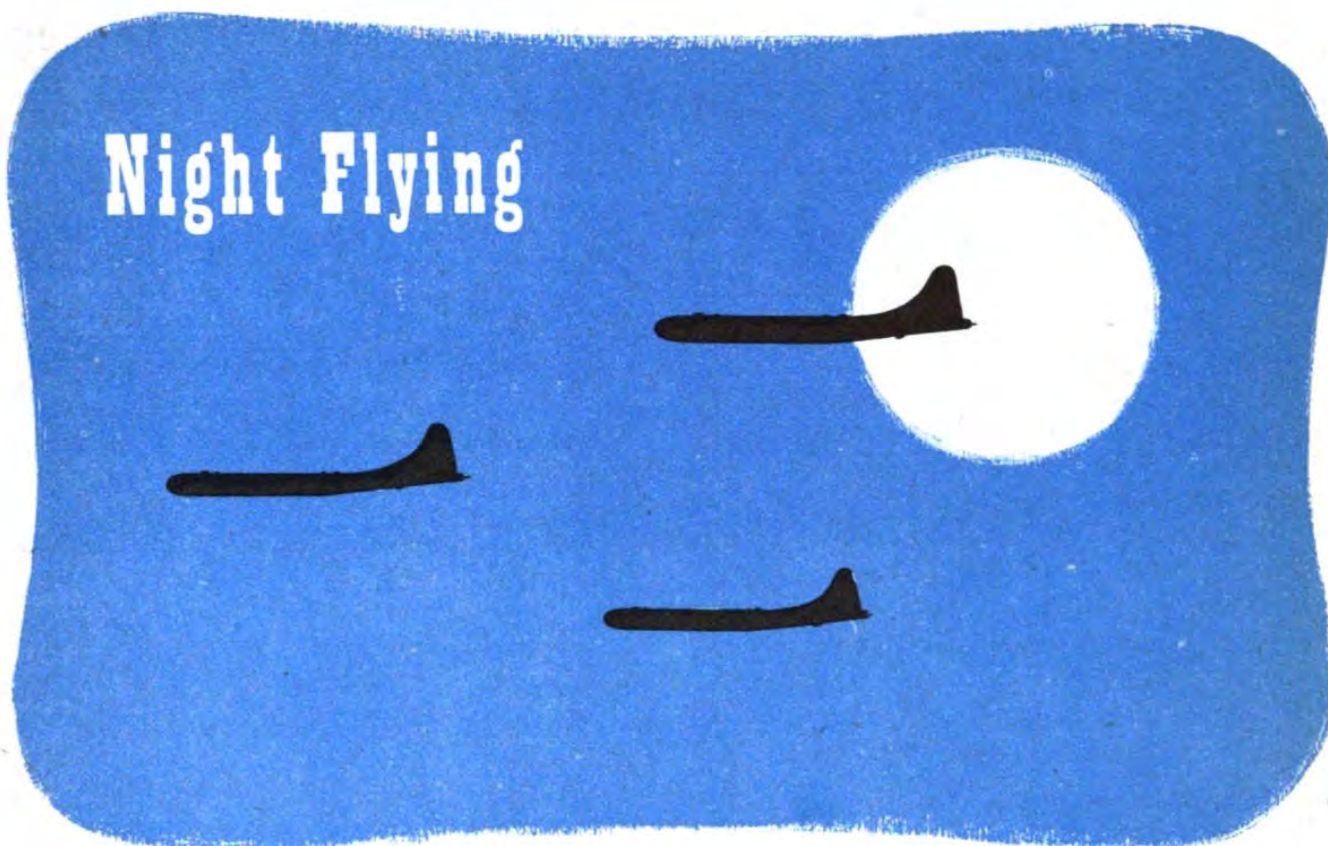

1. Before flight don't subject your eyes to any bright lights: brightly lighted rooms, wing-light beams, bright cockpit lights, etc.

2. Turn out all unnecessary cockpit lights, and dim instrument panel lights. Read instruments, maps, and charts rapidly, then look away.

Night Takeoffs

1. On all night takeoffs climb to 500 feet above the terrain before leveling off to build up airspeed.

2. Obtain clearance from the tower before taxiing to the runway. Line up in the center of the runway and select a distant light as a reference point.

3. If visibility is poor and no horizon is visible, prepare to take off on instruments.

4. Maintain proper airspeed and a constant heading. It is imperative to hold a constant heading until you reach sufficient altitude for the turn.

5. Top and side gunners should warn you if

you are turning into the path of other aircraft.

Night Taxiing

1. When taxiing use the landing lights alternately as needed. This reduces the load on the electrical system imposed by both lights. Continuous ground operation of the lights burns them out quickly. However, don't hesitate to use both lights if necessary.

2. Make frequent checks of wheels and tires.

3. Check for signs of engine roughness.

4. When taxiing close to obstructions or parked aircraft, see that members of the ground crew walk ahead of each wing and direct taxiing by means of light signals.

5. Be particularly careful in judging distance from other taxiing aircraft. Sudden closure of distance is difficult to notice at night.

6. In case of failure or weakening of brakes, stop immediately and have the airplane towed to the line. Faulty brakes are always hazardous. They are certain to cause accidents when taxiing at night.



General

1. Be sure that goggles, side windows, and wind screens are kept scrupulously clean. Scattered light on unclean surfaces reduces the contrast between faint lights and their background.
2. Be sure that all fluorescent lights, wing-lights, navigation lights, passing light, cockpit light, and individual instrument lights are in operating order.
3. Be sure that you, your copilot, and your flight engineer have individual flashlights.
4. Check radio operation and set proper frequencies. You need your radio, especially at night.
5. Know your field layout, the proper relationship of taxi strips to runways, etc. It is easy to become confused at night.

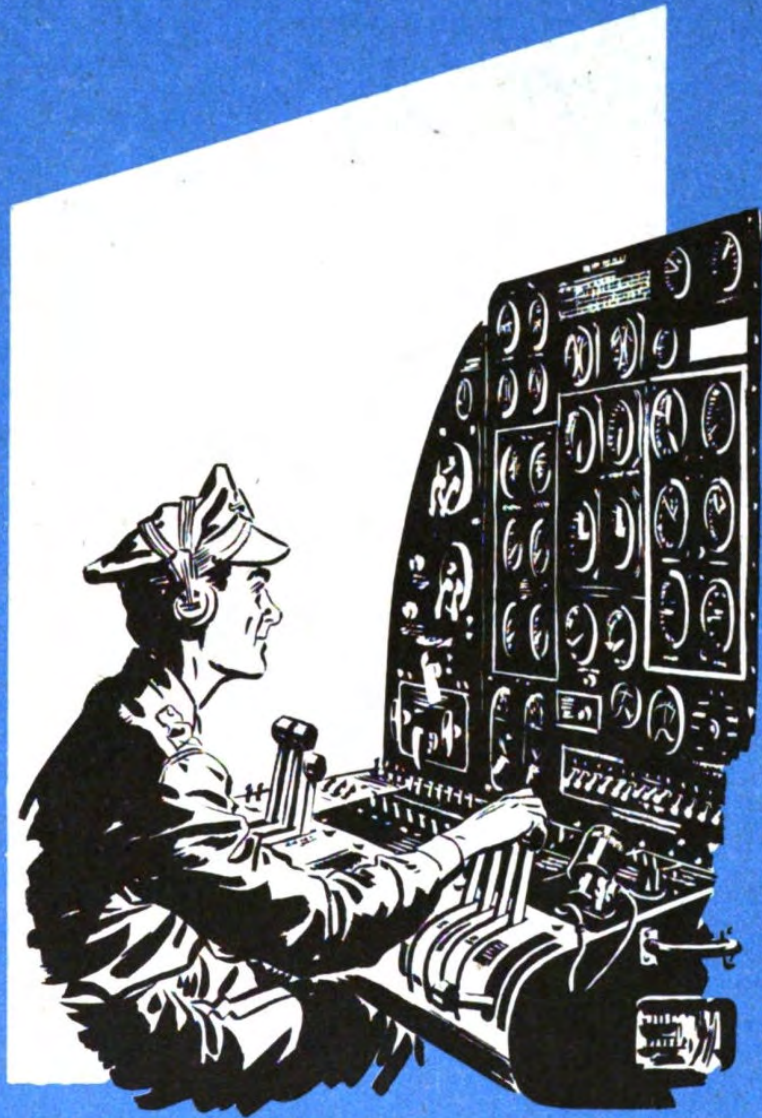

FLIGHT ENGINEER'S PREFLIGHT INSPECTION AND CHECKLIST

Flight Engineer's Preflight Inspection

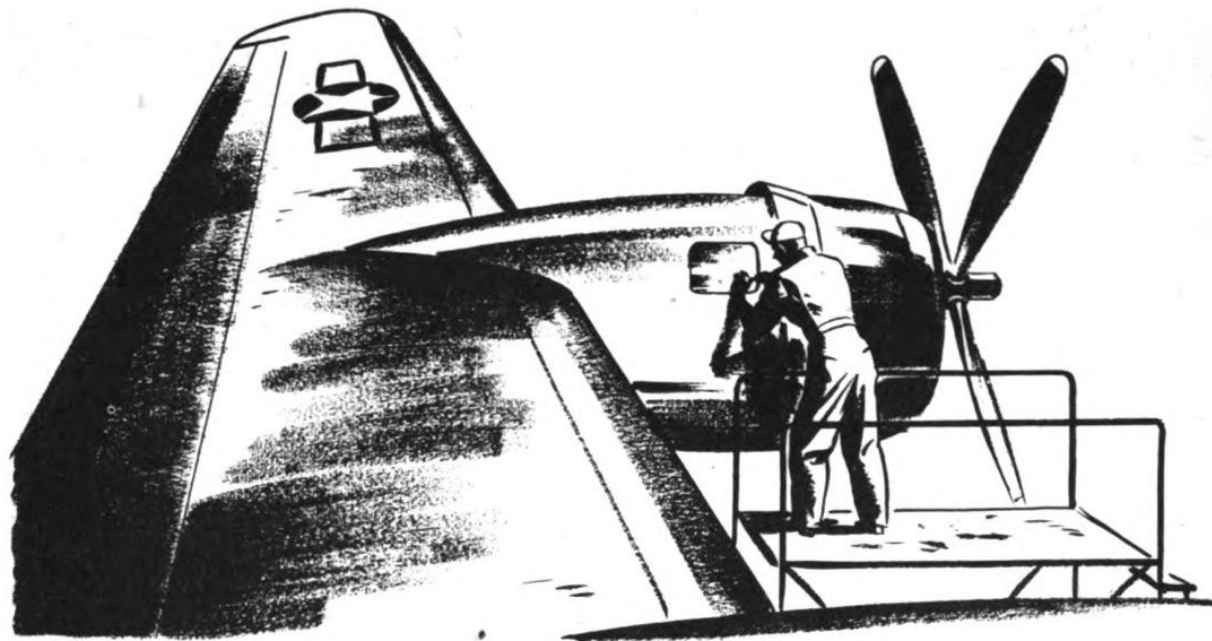

Your preflight inspection is a heavy responsibility which you cannot afford to slight. Remember that the safety of the crew and the success of the whole mission depend in some respect on this preflight inspection of yours. Never assume that maintenance is perfect, or that the checks of others can substitute for your own careful inspection.

You are expected to know the B-29. You are expected also to know the condition of the particular B-29 which you are about to operate. Only by a thorough, professional, complete preflight inspection can you be sure that your airplane is ready to fly and that every necessary item of service and maintenance has been

accomplished so that your airplane and crew can go to work with a minimum of delay and a maximum of efficiency.

The procedures given here comprise an inspection route and a sequence of checks which is arranged to accomplish the preflight with greatest efficiency in a minimum time. However, different facilities and different routines of your own organization may force you to modify this procedure. Regardless of the order in which you perform your preflight check, be sure to include all of the following items and check them in the manner prescribed. These are the minimum checks; others may be added where local conditions require.

Note:

First check Form 1A for the status of the airplane, so that you know what things to give particular attention to in your preflight inspection. Check entries, inspections due, engine and airplane hours, and fuel and oil servicing.

Outboard Wing Panel

1. Position lights: unbroken.
2. Static drains: installed.
3. Skin on underside of wing: no wrinkles, holes, missing rivets, or fuel leaks.
4. Aileron: no wrinkles or holes.
5. Trim tabs: proper droop 1½".
6. Landing light: fully retracted, lens unbroken.
7. De-icer boots: no holes or tears.

Outboard Engine

Note: Be sure ignition switches are OFF.

1. Propeller: pull through four blades (no more than two men to a blade). Check each blade and the propeller dome for freedom from nicks and cracks. As each blade is pulled through listen for blow-by or valve leakage. If there is a liquid lock it can be corrected now, preventing the delay in takeoff which will occur if it is not discovered until later. This procedure, however, does not replace pulling the prop through 12 blades before starting the engine. Don't pull the prop through until the engine has cooled for at least 30 minutes after the last operation.

In case of a liquid lock, you can locate the cylinder containing the liquid by the following method: count the lobes on the magneto cam, starting with the red dotted lobe (No. 1 cylin-

der). The lobe on which the breaker points are riding indicates the cylinder containing the liquid lock. Determine this cylinder from the number of lobes and the firing order. When you find the lock, remove the spark plug, drain the liquid, and install a clean sparkplug.

Never attempt to relieve a liquid lock by applying pressure or by pulling the prop backwards.

2. Engine nose section: clean, no cracks, cylinders free from broken fins, no loose baffles, no loose high tension leads or foreign material in air scoop. See that nose oil sump plug is safetied.

3. Drain lines or vents (Y drain, blower drain, oil separator drain, etc.): open.

4. Air lock fasteners, cowling and panel: secure.

5. Flight hoods, exhaust stacks, shroud covers: secure, no cracks, waste gates open and not binding, free movement of turbo wheels, no buckets missing.

6. Engine oil tank: serviced, cap secure.

7. Turbo oil tank: serviced, cap secure.

8. Feathering oil tank: serviced, cap secure.

9. Engine accessory section: clean, tight lines, rear sump plug safetied, pressure transmitters in proper condition.

Note: Inspection of oil coolers, cowl flaps, intercoolers, and aftercoolers is included in the operational check.

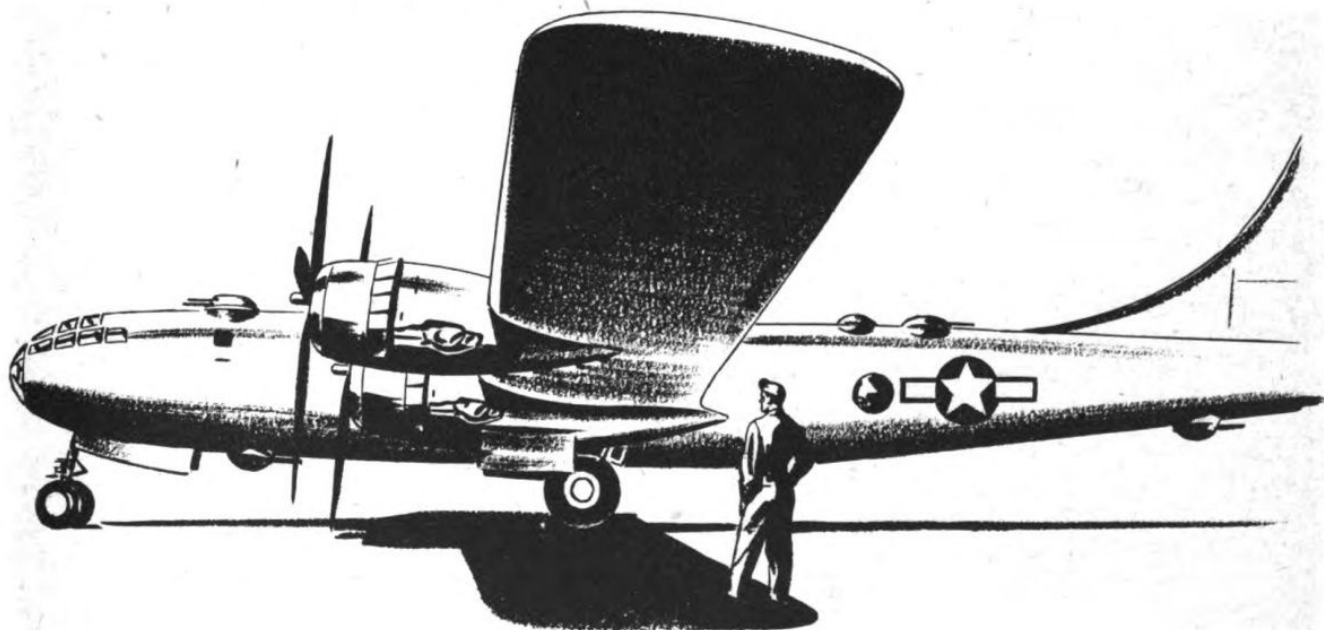



Inboard Engine

Make same inspection that you made on outboard engine.

Landing Gear

1. Doors and retraction units: proper condition.
2. Tires: proper inflation and condition, slip marks aligned (rolling radius 23.3"—axle to ground).
3. Brake assemblies: proper clearance (.010" minimum) and no hydraulic leaks.
4. Strut: proper condition and inflation (13¼" between torsion link pin centers desired).
5. Down locks, wheel chocks (2" from tires), static groundwire: in place.
6. Hydraulic equipment (lines, deboost valves, shuttle valves): proper condition, no leaks.
7. Fuel cross-over lines: proper condition.
8. Electrical cannon plugs, limit switches: properly installed, safetied.
9. Mechanical wheel retraction system: proper condition.

Wing Section

1. Fuel drain access panels: installed.
2. Wing flaps: no fuel leaks, skin in proper condition.
3. Fuel vent: open.
4. Aftercooler air intake: open.

Nose—Left Side

1. Front bomb bay doors: proper condition, no holes.
2. Fuel vents: open.
3. Fuselage skin: proper condition, no wrinkles or holes.
4. Navigator's temperature bulb: not broken or bent.
5. Static holes: clear.
6. Turret cover: secure.
7. Fire extinguisher red rupture disc: intact.
8. Pitot head: not clogged.
9. Windows: clean and unbroken.
10. Bombardier's temperature bulb: not broken or bent.
11. Nosewheel door: proper condition.

Nose Gear and Well

1. Tires: proper inflation (rolling radius: 15.3"—axle to ground), proper condition, slip marks aligned.
2. Wheels: no cracks.

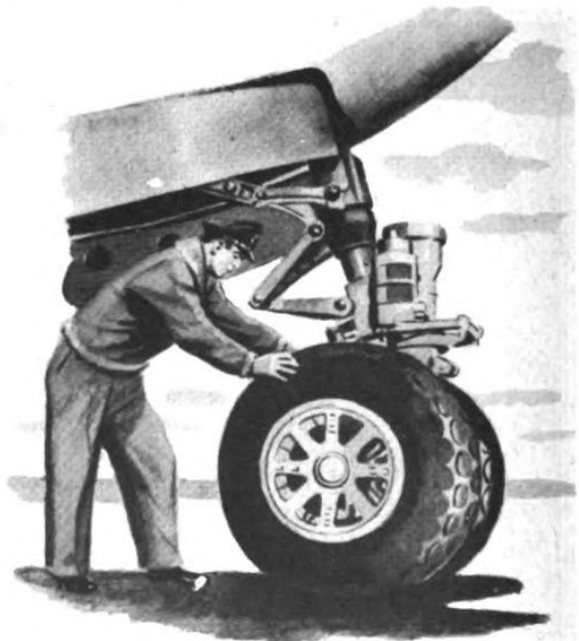

3. Shimmy damper: proper oil level.
4. Oleo strut: proper inflation (10" between torsion link pin centers desired), proper condition.
5. Wheel well door actuating spool: secure.
6. Retraction unit and door actuators: proper condition, no cracks.
7. Cannon plugs: secure and taped.
8. Limit switches: safetied.
9. Gear retraction motor: clutch engaged.
10. CO₂ fire extinguisher bottles: properly installed.
11. Nose gear hand crank: installed on under side of hatch.

Nose—Right Side

1. Nosewheel door: proper condition.
2. Fuselage skin: proper condition, no wrinkles or holes.
3. Windows: clean and unbroken.
4. Pitot head: not clogged.
5. Engineer's temperature bulb: not broken or bent.
6. Static holes: clear.
7. Right front bomb bay door: proper condition, no holes.
8. Fuel vents: open.

9. Radome: no holes.
10. Vents (around radome): open.

Note: from this point proceed to wing and make same inspection of wing, two engines, and landing gear which you completed on the other side.

Aft Fuselage

1. Fuselage skin (sides and bottom): general condition, no wrinkles, holes, or popped rivets.
2. Bomb bay fuel vent: open.
3. Scanning blister: clean, not cracked.
4. Camera doors: closed.
5. Turret cover: secure.
6. Tailskid: proper condition.
7. Tail turret fairing: secure.
8. Tail gunner's window: clean, unbroken.
9. Skin, vertical and horizontal stabilizer: proper general condition, no wrinkles, holes or popped rivets.
10. Rudder and elevators: no holes or wrinkles in fabric covering, hinges in proper condition.
11. Elevator and rudder trim tabs: proper condition and position.
12. Antennas: installed, unbroken.
13. Recognition light lenses: unbroken.



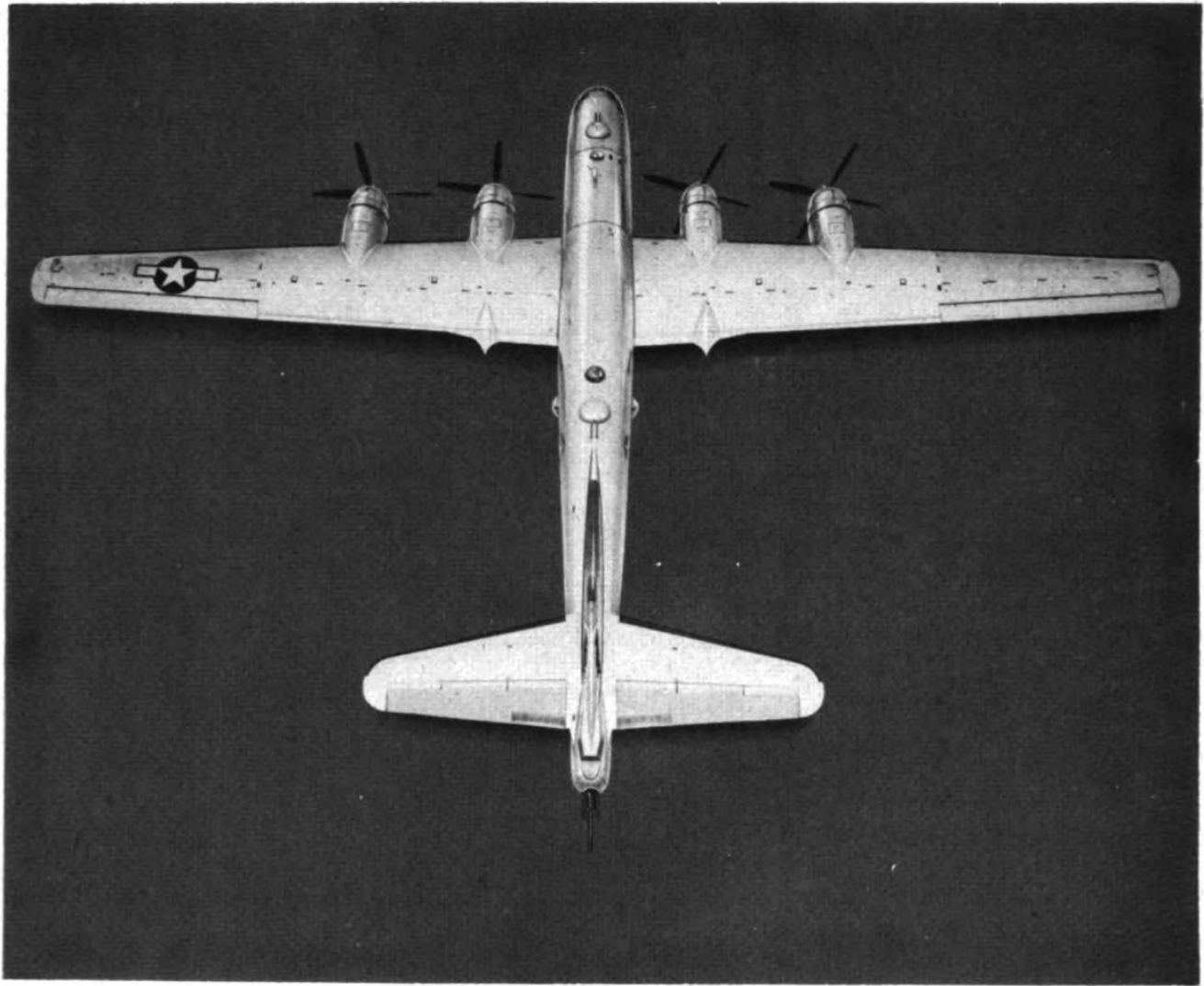

Top of Wing

1. Skin: no holes, wrinkles, or popped rivets.
2. Aileron and trim tab: no wrinkles or holes, fabric coating in proper condition.
3. Formation light lenses: unbroken.
4. All access panels: secure.
5. Engines, as much as is visible from top of wing: no broken fins or loose baffles, sparkplug leads in place.
6. Intercoolers, cowl flaps: no evidence of binding.
7. Airlock fasteners and cowling: secure and in proper condition.
8. Fuel tanks: proper servicing, caps secure.

Upper Fuselage

1. Turret cover: secure.
2. Astrodome: clean, no cracks.
3. Antennas: installed, unbroken.
4. Life rafts doors: secure. Give several heavy tugs on door handles (not emergency release handles) to be sure they are securely locked. Check for presence of life raft through inspection window.
5. Formation light lenses: unbroken.
6. Skin: no holes, wrinkles, missing rivets.
7. CFC blister: clean, no cracks.
8. Upper aft turret cover: secure.
9. Upper empennage: no holes or wrinkles.

Aft Bomb Bay

1. Bomb bay door down locks: installed.
2. Bomb bay doors (inside and outside): hinges and chafing strips in proper condition.
3. Door retraction units (electrical or pneumatic): no external evidence of malfunction. Check cable release system on electrically operated doors.
4. Pneumatic unit: no leaks; air pressure: normal accumulator—1200 to 1500 psi, emergency accumulator (where present): 750 to 850 psi. **Caution: When recharging emergency accumulator open emergency recharging valve slowly until desired pressure is reached, and then close.**
Ask crew chief if condensate was removed from the accumulators during daily inspection.
5. All control valves: closed.
6. Emergency pull handle and pull cable, bomb door latch: proper condition and position.

7. Oxygen system: no leaks.
8. All visible control cables: no evidence of chafing or improper tension.
9. All lines: no evidence of leaks, deterioration, looseness.
10. Portable emergency motor: properly installed in wing flap receptacle, cannon plug connected, switch OFF.
11. Life raft release dogs at center wing: fully engaged. Make detailed inspection of all life raft release cams and roller arms inside bomb bay to assure maximum meshing in fully locked position.
11. All cannon plugs: secure.
12. Landing gear cranks: stowed. Clutch handles: IN.
13. Bomb loading and racks: secure, bomb bay tank safety switch OFF. This switch must be off to prevent accidental salvo of bomb bay tanks or bombs with resulting injury to ground personnel.

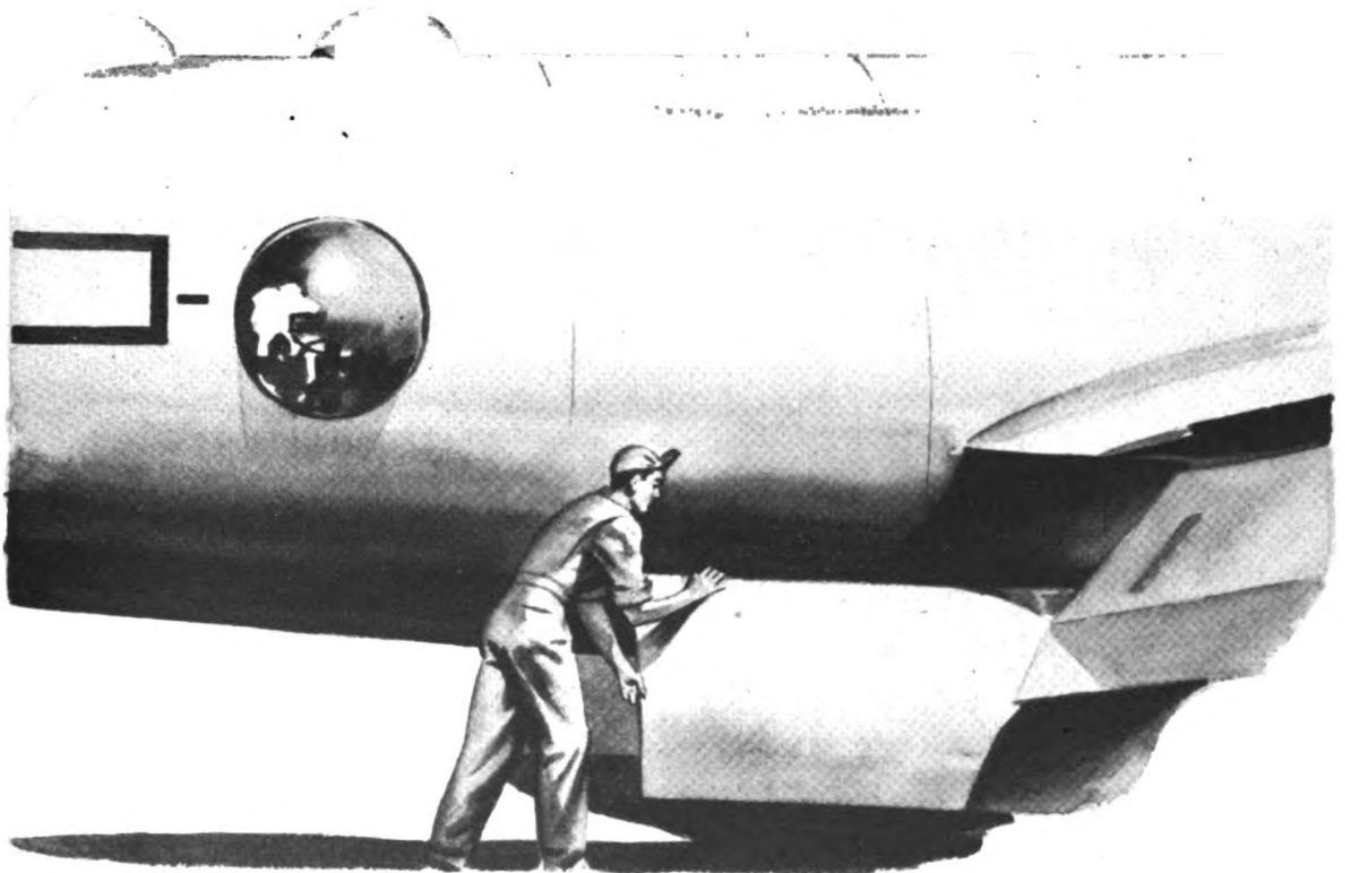

Front Bomb Bay

1. Bomb bay door down locks: installed.
2. Bomb bay doors (inside and outside): no holes, hinges and chafing strips in proper condition.
3. Door retraction units (electrical or pneumatic): no external evidence of malfunction. Check cable release system on electrically operated doors.
4. Pneumatic unit: no leaks; air pressure: normal accumulator—1200 to 1500 psi, emergency accumulator (where present)—750 to 850 psi. **Caution: When recharging emergency accumulator open emergency recharging valve slowly until desired pressure is reached and then close.**
- Ask crew chief if condensate was removed from accumulators during daily inspection.
5. All control valves: closed.
6. Emergency pull handle and pull cable, bomb door latch: proper condition and position.
7. Oxygen system: no leaks.
8. All visible control cables: no evidence of chafing or improper tension.
9. All lines: no evidence of leaks, deterioration, or looseness.
10. Center wing tank and/or bomb bay tank:

proper servicing, no fuel leaks, caps secure.

11. Bomb loading and racks: secure, bomb bay tank safety switch OFF.

Tail Compartment

1. Windows and escape hatch: secure and in proper condition.
2. Tail gun armored access panel: properly installed.
3. All electric light switches: OFF.
4. Spare bulbs: on hand.
5. Oxygen station: pressure 425 plus or minus 25 psi, emergency valve OFF, auto-mix ON (NORMAL), hose in proper condition, walk-around bottles charged to line pressure.
6. Bulkhead door seal and hinge: proper condition.
7. Oxygen bottles: no leaks.
8. Cables and lines: proper condition:
9. Camera hatch: closed.
10. Emergency equipment: stowed.
11. Putt-putt: properly serviced and in proper condition, fuel and oil filler caps secure, circuit breaker ON or bus selector switch in NORMAL position.
12. Battery: proper condition and installation, quick-disconnect in place and in proper condition.

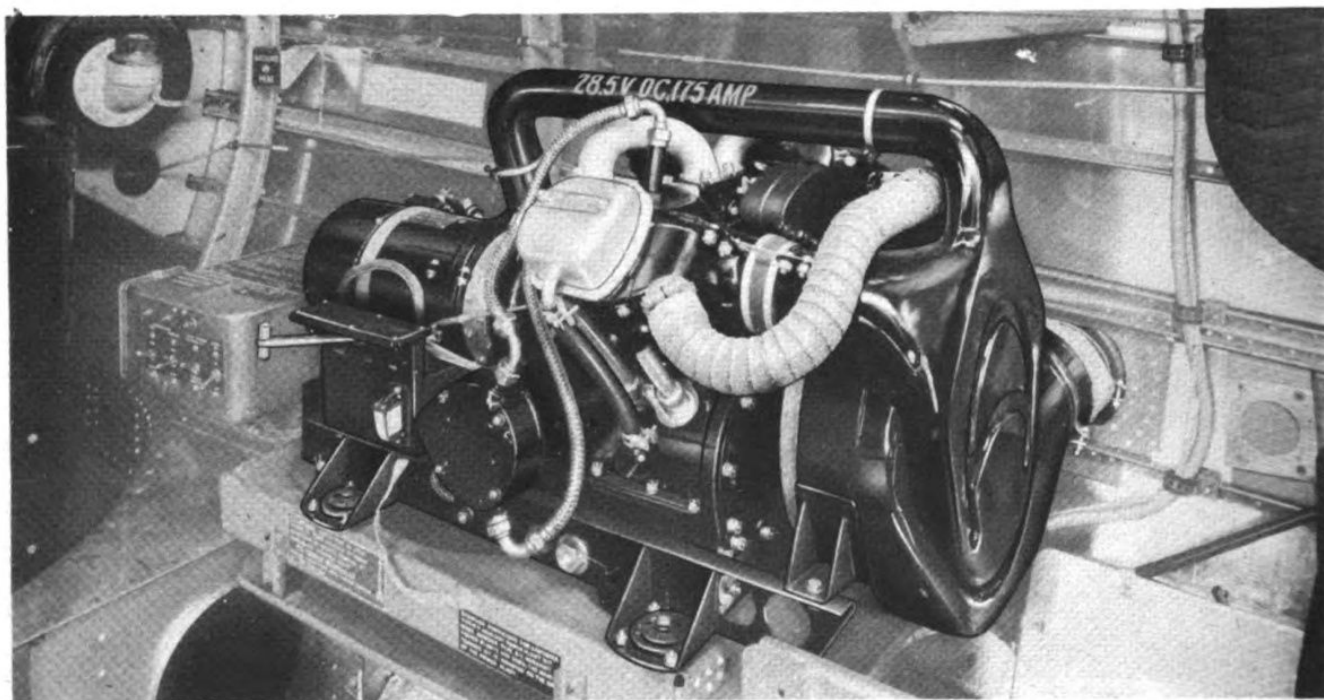

Radar 'Compartment

1. Bulkhead door seal and hinge: proper condition.
2. Emergency pressure relief valve: closed.
3. Vacuum pressure relief valve: free movement.
4. All electric light switches: OFF.
5. All oxygen stations: pressure 425 plus or minus 25 psi, emergency valve OFF, auto-mix ON (NORMAL), hose in proper condition, walk-around bottles charged to line pressure.
6. All emergency equipment: present and properly stowed, seals unbroken.
7. Cable controls: proper tension and condition.
8. Turret dome: properly installed.
9. Entire compartment: clean, ash trays emptied, equipment properly stowed.

Gunners' Compartment

1. Blisters: clean, unbroken, no scratches.
2. All electric light switches: OFF.
3. Defroster fans: OFF.
4. Salvo switches: OFF.

5. Air compressor circuit breaker: ON.
6. Cabin pressure regulators: unlocked.
7. Bulkhead door seal and hinge: proper condition.
8. Door braces: aboard.
9. All oxygen stations: pressure 425 plus or minus 25 psi, emergency valve OFF, auto-mix ON (NORMAL), hose in proper condition, walk-around bottles charged to line pressure.
10. Tail gunner's air supply valve: full OPEN.
11. Entire compartment: clean, ash trays emptied, equipment properly stowed.

Flight Compartment

1. Bulkhead door seal and hinge: proper condition.
2. All oxygen stations: pressure 425 plus or minus 25 psi, emergency valve OFF, auto-mix ON (NORMAL), hose in proper condition, walk-around bottles charged to line pressure.
3. Emergency kits: properly stowed, seals unbroken.
4. Hydraulic fluid quantity: approximately 2 gallons.
5. Air compressor circuit breaker: ON.

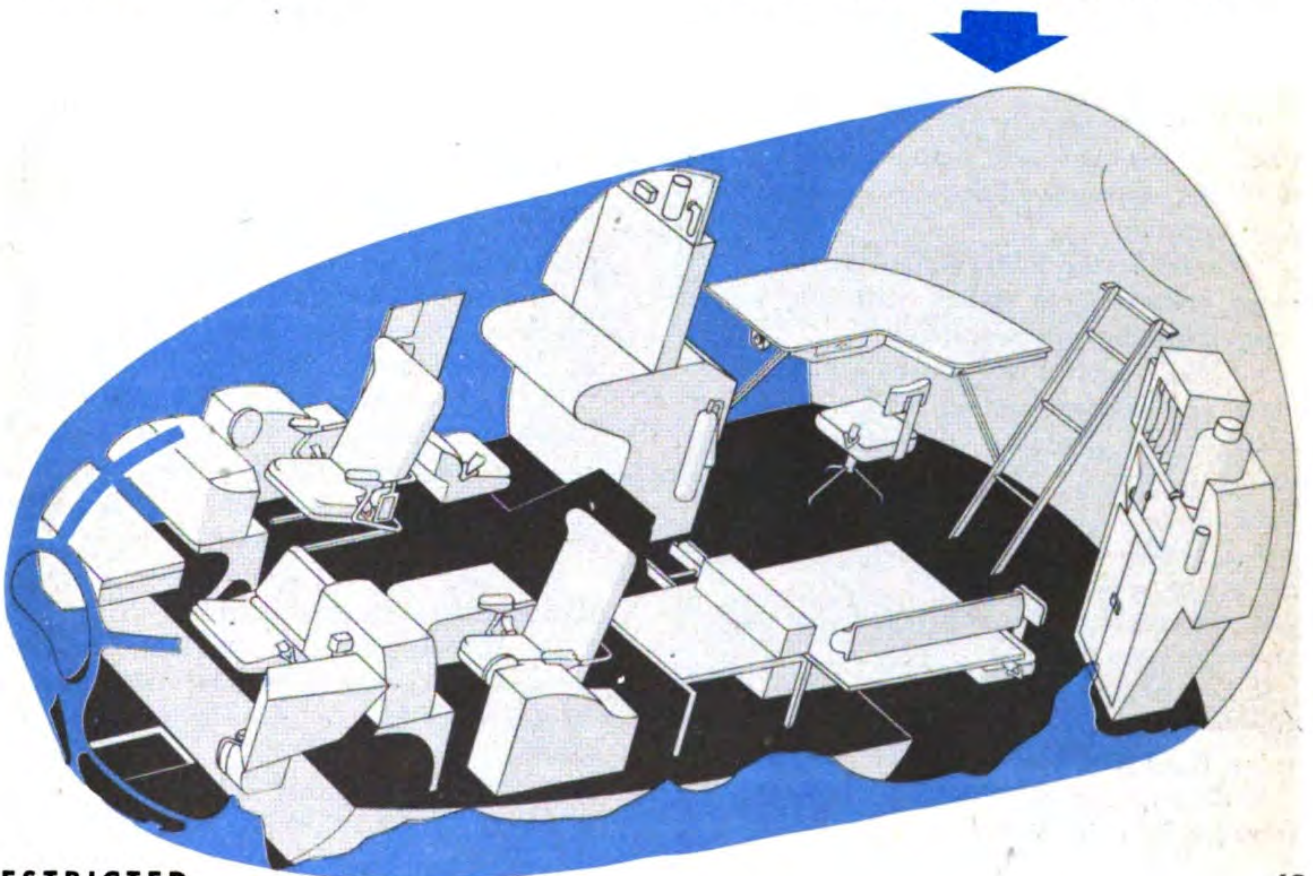

RESTRICTED

6. All voltage regulators: in place.
7. Turret covers: properly installed, ammunition doors closed.
8. Turbo amplifiers: in place. Check for spare.
9. Entrance hatch seal: proper condition.
10. All fuse panel covers: properly installed.
11. Landing gear fuse: in place.
12. All windows: clean, no cracks, airplane commander's and copilot's windows operating properly, engineer's emergency escape window properly installed.

13. Safety belts: present and in proper condition.
14. All light switches: OFF.
15. De-icing fluid: stowed (if required for mission).
16. Electrical wires and tubing: visual check for evidence of external damage. Give particular attention to tubing and wires near the tunnel entrance.
17. Entire compartment: clean, ash trays emptied, no unnecessary equipment aboard.

OPERATIONAL CHECK OF EQUIPMENT

1. Check all switches OFF, then turn on battery switch and start the putt-putt. Check the voltage output on DC voltmeter. Check the current output by momentarily flicking the hydraulic pump switch to the MANUAL position. A momentary voltage drop plus momentary decrease of putt-putt speed are indications that the unit is operating properly. As soon as the putt-putt is checked turn it off and make subsequent operational checks using an external power source.

2. Check the operation of the bomb bay doors from the bombardier's station. Be sure that the locks are removed if doors are pneumatically operated.

Note: Make the following checks at the airplane commander's station with the ground crew observing unit operations:

3. Unlock control lock. Operate rudder, elevators and ailerons noting action of copilot's controls and obtaining verification of correct external control movements from the ground crew.

4. Operate trim tabs, checking as in No. 3. Return to neutral.

5. Operate throttles, noting action of copilot's and engineer's throttles.

6. Set parking brakes and watch normal pressure for a short time for indications of hydraulic leaks. Release brakes.

7. Check emergency brakes—note emergency pressure for evidence of leaks.

8. Operate propeller electric head to both low and high limit settings noting the time required to change from the low to the high rpm setting. The time should be almost the same for all electric heads.

9. Turn the turbo boost selector to No. 10 (inverter ON) and have ground crew check for smooth operation of the waste gates to the closed position. Return TBS to zero. Waste gates should open fully.

10. Operate the wing flaps to the down and up limits and check position indicator. Have ground crew check fuel liquidometers and fuel transfer lines while flaps are down.

11. Check fluorescent instrument lights if night operation is anticipated.

12. Check all external lights if night operation is anticipated: formation, position, recognition, and landing.

13. Be sure to turn lights OFF after checking. Check instruments for broken or loose cover glasses. Make manifold pressure readings.

Note: Perform the following operational checks at the flight engineer's station:

14. Check mixture control lock. Leave unlocked. Check vacuum controls.

15. Operate fuel transfer selector handles noting detent positions. Return to OFF position. Momentarily operate fuel transfer system in all positions.

16. Check emergency cabin pressure valve and leave it open.

17. Check cowl flap operation for open and closed position and freedom from binding. Leave open. Ground crew reports operation.

18. Check intercooler door operation as in No. 17. Leave open.

19. Check oil cooler door operation as in No. 17. Leave open.

20. Check aftercooler doors as in No. 17. Leave closed.

21. Check pitot heaters. Turn ON for approximately 5 seconds and have ground crew member feel the pitot heads to determine if heaters operate. Be sure to turn OFF after checking.

22. Make the following pressure checks:

(Note: Three men are necessary to accomplish these checks, one working at the flight engineer's panel and one at each access door of the engine nacelle.)

Carburetor and Primer Pressure Check

a. Battery switch or external power—ON.

b. Fuel shut-off valve—CLOSED.

c. Fuel booster pump—on LOW.

d. Mixture control—cracked. There should be no indication of fuel pressure.

e. Fuel shut-off valve—OPEN. Check for fuel pressure rise.

Note: Operate fuel shut-off valve by momentary contact of switch. Prolonged energizing burns out actuating coils.

At this time men at nacelle check fuel lines and carburetor for leaks. Check especially around main fuel strainer, mixture control assembly, and fuel drain plug. You can detect small leaks more readily by smell than by sight. In addition one man checks that the mixture control lever operates smoothly with load sufficiently low so that all engines can be set with one hand. He also makes sure that the detents for AUTO LEAN and AUTO RICH mixture control positions are easily and positively located.

f. Mixture control—FUEL SHUT-OFF (Five seconds of fuel pressure indication is maximum, in order to avoid liquid lock.)

g. Toggle primer switch. Man at nacelle listens for clicking of solenoid and watches primer line connection for spray and droplets of fuel.

h. Check all safetying of carburetor, espe-

cially after 25, 50, and 100-hour inspections.

Fuel Inspection Pressure Check

a. Fire guard—posted.

b. Putt-putt or external power—ON.

c. Ignition switches—OFF.

d. Fuel shut-off valve—CLOSED.

e. Fuel booster pump — on LOW. There should be no indication of fuel pressure.

f. Fuel shut-off valve—OPEN. Check for fuel pressure indication.

g. Mixture control—AUTO RICH.

h. Throttles—FULL OPEN.

i. Rotate propeller 8 to 10 seconds (maximum 15 seconds) **by direct cranking.**

At this time men at nacelle check fuel lines, master control box, and both pumping units for leaks. In addition one man checks that mixture control lever operates smoothly with load sufficiently low so that all engines can be set with one hand. Also he makes sure that the detents for AUTO LEAN and AUTO RICH mixture control positions are easily and positively located.

Have member of the flight crew or ground crew clear propeller and give signal for direct cranking. After engine rotation, check fuel lines and fittings in front of engine.

Note: Hold this check to a minimum to prevent washing oil from cylinder walls of the engine.

23. Check normal and spare inverter output, noting airplane commander's and engineer's warning lights.

24. Check fluorescent instrument lights.

25. Check wheel well lights if night landing or takeoff is anticipated.

26. Check electrical instruments: carburetor air temperature, oil temperature, fuel and oil quantity gages, cowl flaps and inter-cooler indicators, hydraulic pressure (charge if necessary), wind and set clock, and note manifold pressure readings. The purpose of checking airplane commander's and engineer's manifold pressure gages is to find which instruments read more nearly correct. Power settings then should be made using the better set of instruments or by applying a correction factor to instruments that read incorrectly.

RESTRICTED

27. Ask crew chief if the bomb release system was checked before loading the bombs and if emergency equipment is in the life raft compartments.

28. Compute the weight and balance.

CREW INSPECTION

Flight engineer joins other crew members for crew inspection.

Following crew inspection, make the follow-

ing checks before entering the airplane.

1. Pitot covers: removed.

2. Forms 1, 1A, F, loading list: completed. Give Forms 1A and F and/or loading list to the airplane commander for approval and signature.

3. Propellers: pulled through. Airplane commander checks that all ignition switches are OFF and signals to other crew members or the ground crew to pull the props through. Pull the props through at least 12 blades with not more than two men to a blade.

4. Down locks (gear and bomb door): removed.

5. Chocks: 2" in front of wheels.

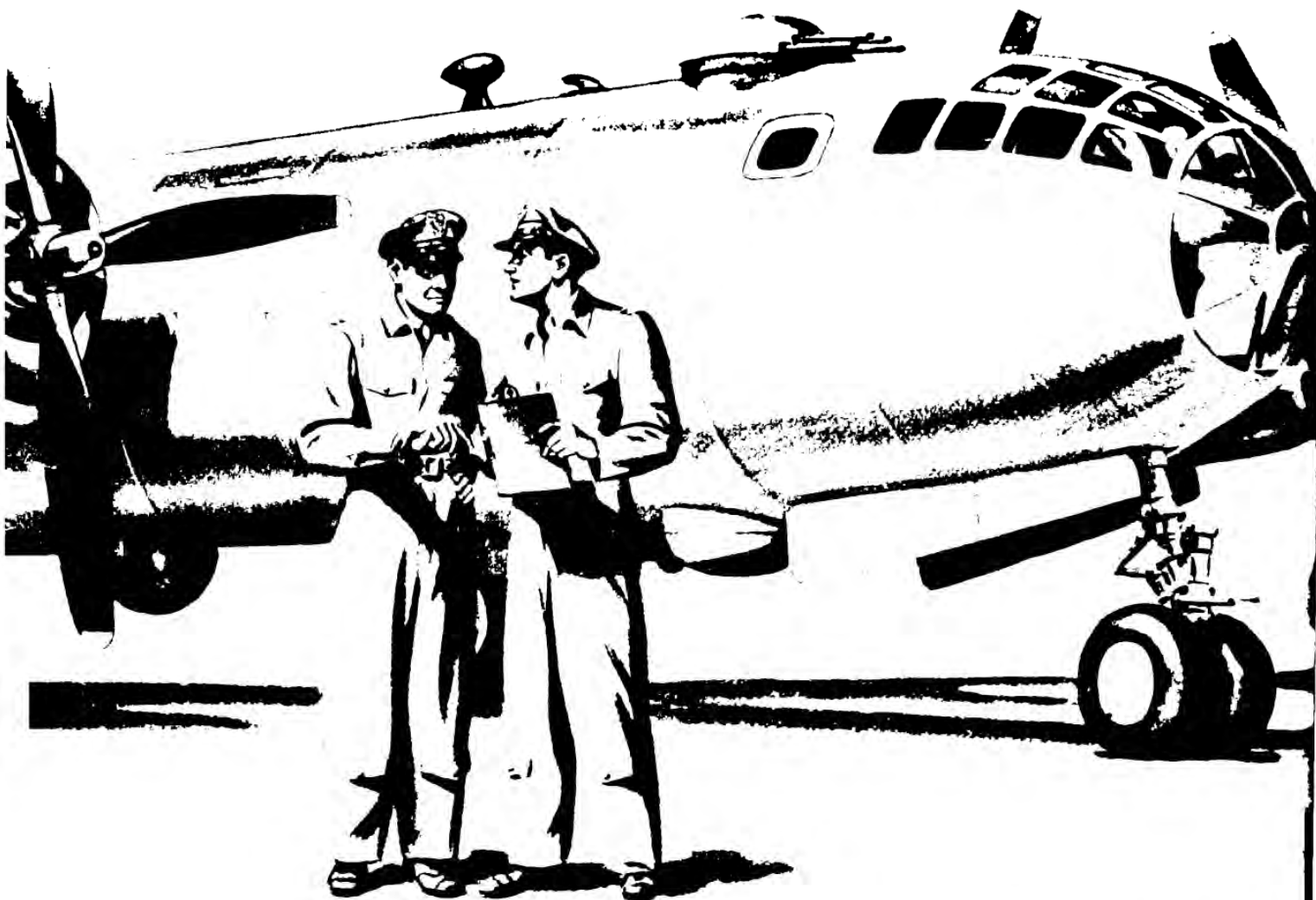

Flight Engineer's Checklist

RESTRICTED

BEFORE STARTING

1. FLIGHT PLAN.....COMPLETED
2. FLIGHT ENGINEER'S PREFLIGHT...COMPLETED
3. FORMS 1, 1A, F.....ON BOARD AND SIGNED
4. PROFESSIONAL EQUIPMENT.....CHECKED AND ABOARD
5. FLIGHT LOG.....INITIATED
6. BATTERY SWITCH.....ON
7. MASTER IGNITION SWITCH.....ON
8. PUTT-PUTT.....START AND CHECK FOR ON THE LINE
9. INSTRUMENTS.....CHECKED
10. COWL FLAPS.....FULL OPEN
11. INTERCOOLERS.....OPEN TO 7½°
12. OIL COOLERS.....AUTOMATIC
13. DE-ICERS, ANTI-ICER SWITCH
& RHEOSTATS.....OFF
14. BOMB BAY FUEL TANK VALVE...CLOSED
15. GENERATOR SWITCHES.....OFF
16. INVERTER.....CHECK ALTERNATE; NORMAL ON
17. FUEL TRANSFER SWITCHES AND
TANK SELECTORS.....OFF
18. HYDRAULIC PRESSURES.....1000 PSI
19. EMERGENCY HYDRAULIC
SYSTEM VALVE.....CLOSED
20. FUEL SHUT-OFF VALVES.....OPEN
21. STARTER CIRCUIT BREAKERS.....ON
22. PITOT HEATERS.....OFF
23. FUEL TRANSFER CIRCUIT
BREAKERS.....ON
24. CABIN PRESSURE WARNING
SWITCH.....ON
25. OXYGEN REGULATOR AND
PRESSURE.....CHECKED
26. CABIN PRESSURE RELIEF VALVE...CLOSED
27. CABIN AIR VALVES.....CLOSED
28. THROTTLES.....SET TO START
29. MIXTURE CONTROLS.....UNLOCKED; CARBURETOR—FUEL
CUT-OFF, INJECTION—AUTO RICH
30. OIL QUANTITY GAGE.....RECORD AND CHECK AGAINST
DIP STICK
31. FUEL QUANTITY GAGE.....RECORD AND CHECK AGAINST
DIP STICK
32. LIGHTS.....AS REQUIRED
33. FIRE EXTINGUISHERS.....SET TO ENGINE BEING STARTED
34. FUEL BOOSTER PUMPS.....ON LOW
35. FLIGHT ENGINEER'S REPORT.....READY TO START ENGINES
36. START ENGINES.....1, 2, 3, 4
37. ENGINE INSTRUMENTS.....CHECKED
38. VACUUM SELECTOR.....CHECKED
39. FLIGHT ENGINEER'S REPORT.....READY TO TAXI

RESTRICTED

73

1. MIXTURE CONTROL.....AUTO RICH
2. GENERATORS.....CHECKED AND ON
3. ENGINE RUN-UP.....COMPLETED
4. INVERTER VOLTAGE.....CHECKED
5. FUEL BOOSTER PUMPS.....ON LOW
6. FLIGHT ENGINEER'S REPORT.....MIXTURE AUTO RICH, FUEL BOOST ON,
GENERATORS ON, STANDING BY ON
COWL FLAPS, READY FOR TAKEOFF
7. COWL FLAPS.....AT START OF TAKEOFF ROLL CLOSE
FROM 15° TO 7½° OR LESS

1. GENERATORS.....CHECK WHILE GEAR IS BEING RAISED
2. ENGINE CHECK.....SCANNERS' REPORT
3. COWL FLAPS.....AS REQUIRED
4. PUTT-PUTT.....STOP AFTER GEAR AND FLAPS ARE UP
5. FUEL BOOSTER PUMPS.....ON LOW
6. INTERCOOLERS.....AS REQUIRED

1. MIXTURE CONTROL.....AUTO RICH
2. PUTT-PUTT.....START AND ON THE LINE
3. FUEL BOOSTER PUMPS.....ON LOW
4. HYDRAULIC PRESSURES.....1000 PSI
5. PITOT HEATERS.....AS REQUIRED
6. ANTI-ICERS.....AS REQUIRED
7. DE-ICERS.....OFF
8. WHEEL WELL LIGHTS (NIGHT).....ON
9. GENERATORS.....CHECKED WHILE GEAR IS
COMING DOWN
10. COWL FLAPS.....AS REQUIRED
11. INTERCOOLERS.....OPEN TO 7½°
12. INVERTER VOLTAGE.....CHECKED
13. FLIGHT ENGINEER'S REPORT.....GROSS WEIGHT____LBS., PUTT-PUTT
ON LINE, READY TO LAND

1. COWL FLAPS.....FULL OPEN
2. GENERATORS.....OFF
3. HYDRAULIC PRESSURES.....CHECKED
4. FUEL BOOSTER PUMPS.....OFF
5. ENGINE RUN-UP.....COMPLETED
6. STOP ENGINES.....FUEL CUT-OFF
7. ALL SWITCHES.....OFF
8. PUTT-PUTT.....OFF
9. WHEEL CHOCKS.....IN PLACE
10. DOWN LOCKS (GEAR AND
BOMB DOOR).....IN PLACE
11. PITOT COVERS.....IN PLACE
12. FORMS 1, 1A, FLIGHT LOG.....COMPLETED
13. GIVE CREW CHIEF REPORT
OF MALFUNCTIONS

Before Starting



1. Flight Plan Completed

2. Flight Engineer's Preflight Completed

The complete and detailed preflight inspection procedure is included in a preceding section under the heading **Flight Engineer's Preflight Inspection**.

3. Forms 1, 1A, F on Board and Signed

Check forms 1 and 1A. Advise the airplane commander of status of airplane and that forms are on board.

4. Professional Equipment Checked and Aboard

Check for proper clothing for the mission to be performed. Make the standard preflight check on your parachute. Adjust your headset and throat microphone, and attach your oxygen mask to the left side of your helmet.

For overwater missions examine your life preserver vest and check its CO₂ capsules for safetying. Wear your parachute over the vest.

Note: Stay on interphone at all times unless

otherwise authorized by the airplane commander.

5. Flight Log Initiated

6. Battery Switch ON

At the copilot's call, you as flight engineer turn the battery switch on and report: "**Battery switch ON.**" All electrical circuits can be energized by either battery or putt-putt, or both. Both are used for normal ground operation on loads up to 200 amperes. For additional power use an external source.

Note: Check the normal inverter switch OFF before turning the battery switch on.

7. Master Ignition Switch ON

8. Putt-putt Start and Check for ON THE LINE

Have the tail gunner start the putt-putt, warm it up and place it ON THE LINE. Check for 28 volts.

9. Instruments Checked

Check the CHT and CAT gages against OAT.

RESTRICTED

75

RESTRICTED

Check the tachometer, rate of climb, oil and fuel pressure gages for zero reading. Set both altimeters at 29.92" Hg. Check the MP gages for uniform readings. Flight personnel will not attempt to adjust gages.

10. Cowl Flaps Full Open

Keep the cowl flaps full open for all ground operation.

11. Intercoolers Open to 7½°

Keep the intercoolers full open for all ground operations.

12. Oil Coolers AUTOMATIC

Put the switch in AUTOMATIC. The oil cooler flaps will then adjust themselves to maintain correct oil temperatures.

13. De-icers, Anti-icer Switch and Rheostats OFF

14. Bomb Bay Fuel Tank Valve CLOSED

Close the valve to separate the two bomb bay tanks.

15. Generator Switches OFF

16. Inverter Check Alternate; NORMAL ON

Check ALTERNATE inverter and voltage reading. Allow ALTERNATE inverter to coast down, and then turn NORMAL inverter on.

17. Fuel Transfer Switches and Tank Selectors OFF

Turn the switches off to prevent inadvertent transfer or transfer by gravity.

18. Hydraulic Pressures 1000 PSI

Check both hydraulic pressures for proper readings. When the copilot asks for emergency hydraulic pressure you report: "1000 PSI." If the pressure is not within the normal range of 900 to 1075 psi, service the emergency accumulator.

19. Emergency Hydraulic System Valve CLOSED

20. Fuel Shut-off Valves OPEN

Open the valves to allow fuel to flow to the carburetors.

21. Starter Circuit Breakers ON

22. Pitot Heaters OFF

23. Fuel Transfer Circuit Breakers ON

24. Cabin Pressure Warning Switch ON

25. Oxygen Regulator and Pressure Checked

Check for oxygen pressure of 425 plus or minus 25 psi. Check operation of the regulator and blinker, and see that the hose collar at the regulator is screwed down tight. Auto-mix should be ON (NORMAL) and the emergency valve OFF. Check the walk-around and bailout bottles for proper pressures.

26. Cabin Pressure Relief Valve CLOSED

Close the valve only until it seats firmly. Excessive pressure tends to damage the light structure of the valve.

27. Cabin Air Valves CLOSED

Keep cabin air valves closed until after take-off to avoid possibility of smoke being forced through the induction system into the cabin, and a slight loss of power on takeoff.

28. Throttles Set to Start

Set the throttles at 1½" open. This gives approximately 800 to 1000 rpm and prevents backfiring during starting.

29. Mixture Controls Unlocked; Carburetor—FUEL CUT-OFF, Injection—AUTO RICH

30. Oil Quantity Gage—Record and Check Against Dip Stick

31. Fuel Quantity Gage—Record and Check Against Dip Stick

32. Lights as Required

If night flight is planned, check for proper operation of the fluorescent lights and wheel well lights. For day flights turn off unnecessary lights.

33. Fire Extinguisher Set to Engine Being Started**34. Fuel Booster Pumps On LOW**

Turn the fuel boost on **LOW** and check pressure. Fuel pressure should be approximately 9 to 12 psi.

35. Flight Engineer's Report—Ready to Start Engines

When the copilot calls for this report and if you are ready, you reply: **"Ready to start engines."**

36. Start Engines 1, 2, 3, 4.**Carburetor Type Starting Procedure:**

- a. Fire extinguisher—set to the engine being started.
- b. Master ignition switch—**ON**.
- c. Mixture controls—**FUEL CUT-OFF**.
- d. Throttles—set to start: $1\frac{1}{2}$ " open.
- e. Fuel booster pumps—on **LOW**.
- f. Fuel shut-off valves—**OPEN**. When the airplane commander calls for starting No. 1 engine, you report: **"Energizing No. 1."**

g. Energize the starter 12 to 16 seconds. Report: **"Meshing No. 1."**

h. Engage the starter.

i. After one revolution of the propeller (four blades) turn the ignition switch to **BOTH**.

j. Prime as needed to start and when the engine is firing regularly (500 to 800 rpm) move the mixture control to **AUTO RICH** and release the primer. Use **AUTO RICH** for all ground operations.

Note: Too little prime causes backfiring; too much floods the engine.

k. Fuel booster pumps—**OFF**.

l. Check the starter switches for neutral positions.

m. Engine instruments—checked. Check nose and rear oil pressures, rpm, oil temperature and manifold pressure.

When No. 1 engine is running properly, report: **"Engine operating normally. Ready to start No. 2 engine."** When the airplane commander says: **"Clear on two,"** you reply: **"Starting two."**

Repeat the procedure for each engine. You, the flight engineer, will control the throttles

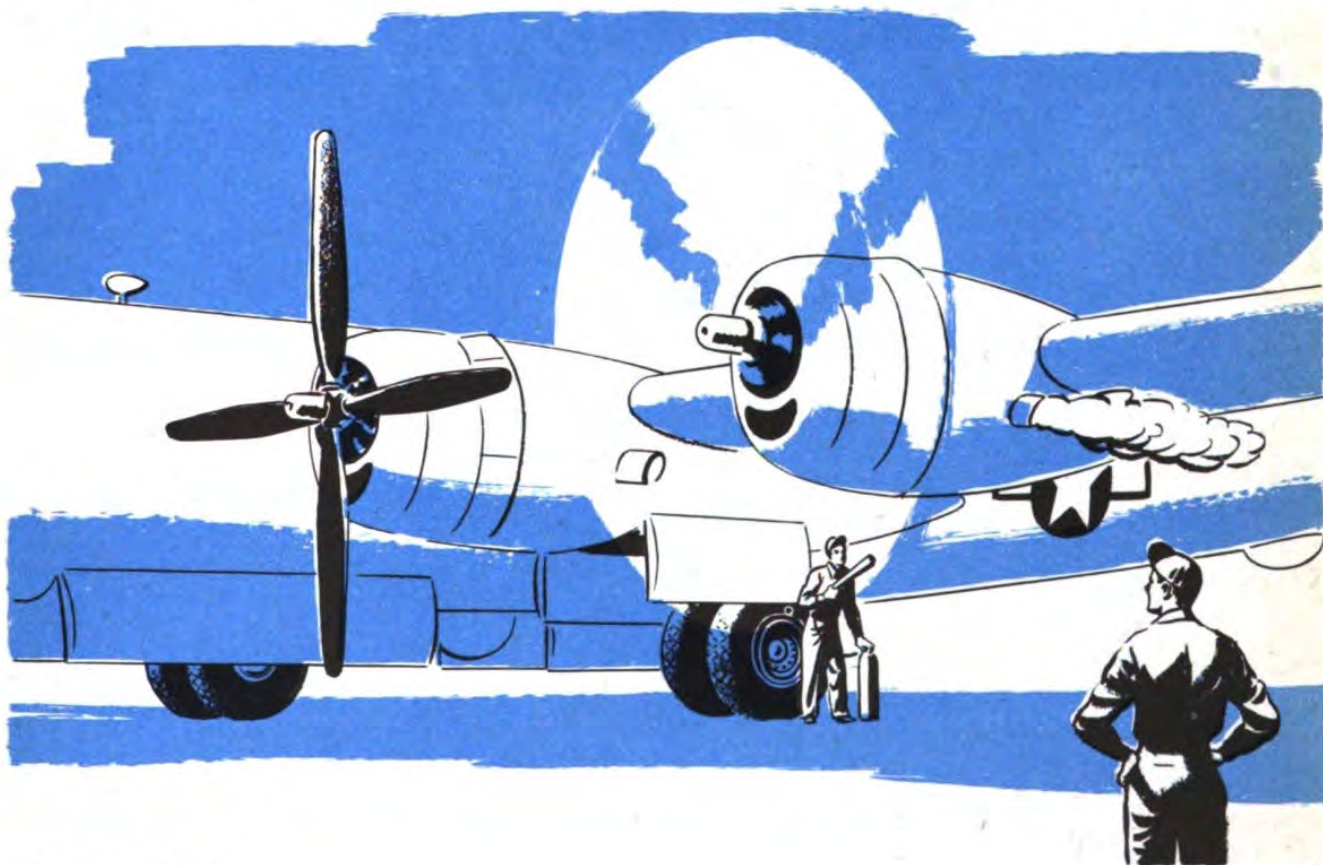

RESTRICTED

throughout the starting procedure, keeping rpm between 1000 and 1200 until the oil temperature is 40° C. When all engines are running set the throttles at 700 to 1000 rpm (1000 rpm if oil temperature is below 40° C). Thereafter the airplane commander controls the throttles except when calling for engine-driven generators and during engine run-up for magneto check. If you see an engine loading up (black smoke or rpm drop, or both) inform the copilot. Do not let the engines idle below 700 rpm.

Bendix Injection Type Starting Procedure:

- a. Fire extinguisher—set to engine being started.
- b. Master ignition switch—ON.
- c. Mixture controls — AUTO RICH (AUTO RICH for all ground operations).
- d. Throttles—set to start: 1½" open.

e. Fuel booster pumps—on LOW.

f. Fuel shut-off valves—OPEN. When the airplane commander calls for starting No. 1 engine, you report: "**Energizing No. 1.**"

g. Energize the starter 12 to 16 seconds. Then report: "**Meshing No. 1.**"

h. Engage the starter. After one revolution (four blades) turn the ignition switch to BOTH. Hold the meshing switch in until the engine begins to fire.

If the engine is warm it may be necessary to have the mixture control in FUEL CUT-OFF until the ignition switch is ON.

i. Fuel booster pumps—OFF. Check the engine-driven pumps.

j. Check the starter switches for neutral.

k. Engine instruments—checked. (See Item m. under carburetor starting procedure.)

STARTING DON'TS

- a. Don't start the engines until the Before Starting Checklist has been covered item by item.
- b. Don't start the engines until the propellers have been pulled through to eliminate any possibility of liquid locks. Never back up propellers on liquid locks.
- c. Don't start the engines until the fire guard is posted.
- d. Don't jam the throttles forward at any time.
- e. Don't jockey the throttles during the starting procedure.
- f. Don't continue to run an engine unless you get an oil pressure indication within 10 seconds and unless nose and oil pressures build up to normal within 30 seconds after starting.

37. Engine Instruments Checked

	MINIMUM	DESIRED	MAXIMUM
Nose oil pressure	20 psi	30-50 psi	50 psi
Rear oil pressure	60 psi	60-80 psi	80 psi
Oil temperature	40° C	50-85° C	95° C
Fuel pressure	15 psi	16-18 psi	19 psi
Vacuum		3.8"-4.2" Hg	

38. Vacuum Selector Checked

Check the vacuum gages. Vacuum should be from 3.8" to 4.2" Hg. on both No. 2 and No. 3 engines. When the copilot calls: "Check vacuum," you reply "Vacuum OK. Vacuum on No." (No. of engine on which vacuum pump is operated.)

Note: Do not move the vacuum selector valve on the engineer's control stand except in making this check. Frequent use of the valve causes unnecessary wear.

39. Flight Engineer's Report—Ready to Taxi

When the copilot calls on interphone: "Stand by to taxi" you reply: "Ready to taxi," if engines are running properly and you are ready to go. If you are not ready to taxi, let him know.

During taxiing the copilot calls for recharging the emergency system. On this order, you service the emergency system and report: "Emergency system recharged."

Watch engine operation while taxiing. If an engine loads up or you detect a torching turbo notify the copilot. If an engine loads up while taxiing, make notation in Form 1.

Before Takeoff

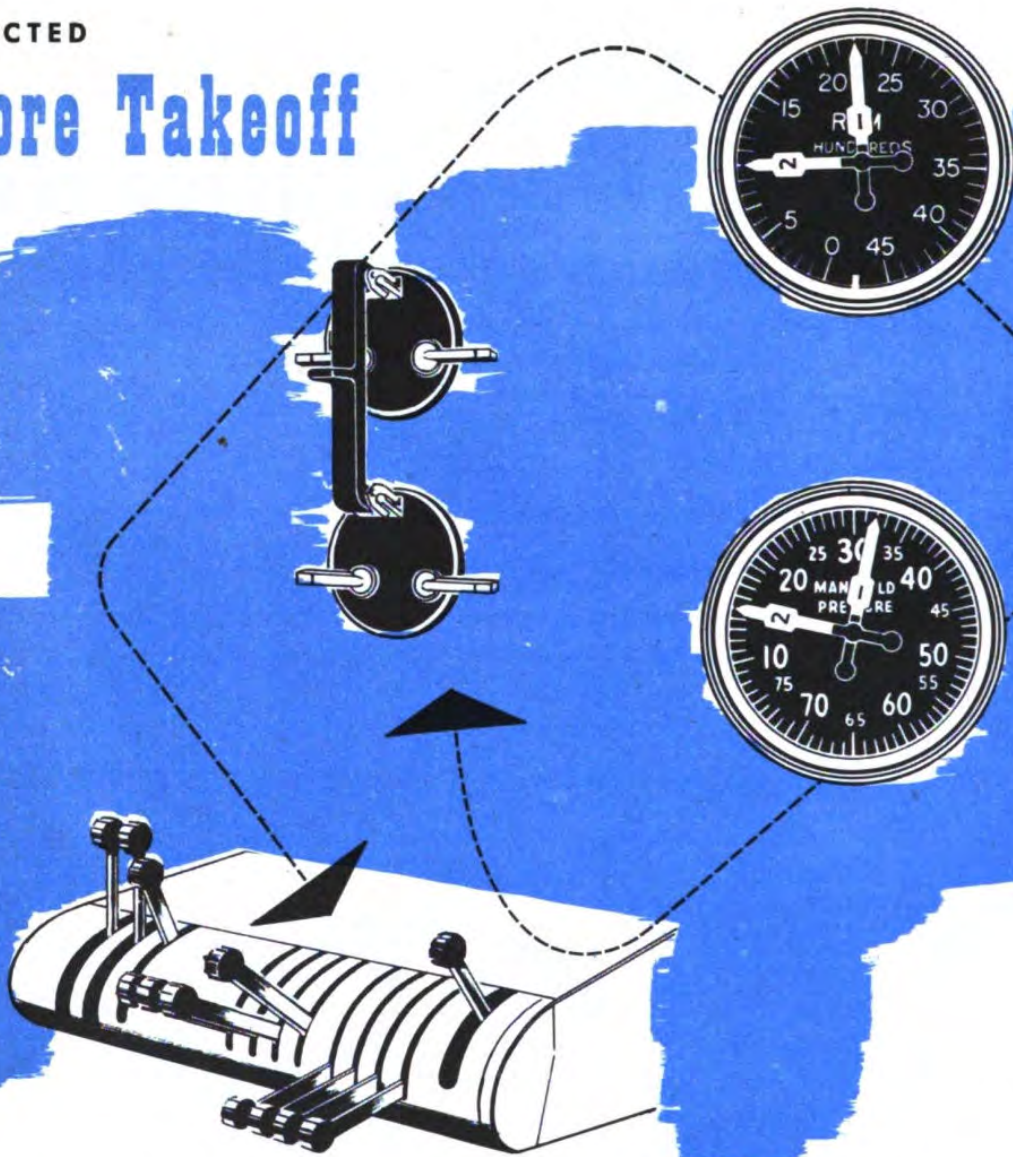

1. Mixture Control AUTO RICH

Keep the mixture control in AUTO RICH setting for all ground operation and for takeoff.

2. Generators Checked and ON

The airplane commander gives the command: "Stand by for engine run-up," and the copilot repeats the command over the interphone. The airplane commander increases all throttles to 1500 rpm and commands: "Check generators." The copilot starts the flaps down and tells you, the flight engineer, to check the generators. (Flaps are run to 25° position and then returned to 0°.)

Note: The flaps are run down at this time in order to have a large electrical load on the normal bus so that you can properly check the

generators. The airplane commander checks props at this time.

Check the generators one at a time for amperage and voltage. After checking individually put all generators ON to check the equalizer system. Leave the generators ON for takeoff. After generator check, place the voltage selector to BUS position. Report to copilot: "Generators OK."

3. Engine Run-Up Completed

Advance the throttle to obtain 2200 rpm and call out the manifold pressure to the copilot. Then check the magnetos for rpm drop, calling to the copilot: "Right, both, left, both." Watch for rpm drop in excess of the 100 allowed. If a magneto drops 100 to 200 from bad plugs, proceed with the full power check, then return

to 2200 rpm and re-check the magnetos on the bad engine. Five seconds is the maximum allowable time for magneto check.

Note: Approximately 32" with 2200 rpm is normal manifold pressure at sea level. Above sea level subtract 1" for each 1000 feet of altitude. Changes in temperature vary these settings but the variation is the same for all engines. Excessive MP on one engine indicates a bad cylinder or some other engine malfunction. If manifold pressure differential on one or more engines exceeds normal by 2" or more, recommend to the airplane commander that he return the airplane to the line for an engine check.

If the airplane commander makes a full-power no-boost check, watch for indications of induction leaks, incorrect waste gate position, dead cylinder from bad valve, dead plugs, broken fuel injection lines, and engine roughness. A rough-running engine is a reliable indication that something is wrong. Manifold pressure of 40" is normal at sea level with the above altitude correction applying. Engine trouble reduces rpm and manifold pressure. Faulty position of the waste gate or an induction leak between turbo and carburetor may cause high manifold pressure and rpm.

At this time the airplane commander makes his full-power check with turbos set for takeoff. Check the engine instruments for proper readings.

See **Curtiss Electric Propeller System** for additional checks on that installation.

4. Inverter Voltage Checked

5. Fuel Booster Pumps On LOW

Watch fuel pressure carefully on takeoff.

6. Flight Engineer's Report

- A. MIXTURE—AUTO RICH
- B. FUEL BOOST—ON
- C. GENERATORS—ON
- D. STANDING BY ON COWL FLAPS
- E. READY FOR TAKEOFF

When the airplane commander says: "Stand by for takeoff" you report as above. When the airplane moves into takeoff position close the cowl flaps to 15°.

7. Cowl Flaps—At Start of Takeoff Roll Close From 15° to 7½° or Less

Start closing the cowl flaps at the beginning of the takeoff roll so that when the wheels leave the ground, cowl flaps will be closed to 7½° or less.

ENGINE LIMITATIONS

Condition	RPM	MP	CHT	Time Limit
Takeoff	2800	49"	260° C	5 minutes
Climb	2400	43.5"	248° C	Continuous

During takeoff roll watch manifold pressure, rpm and engine instruments and report any irregularities to the copilot.

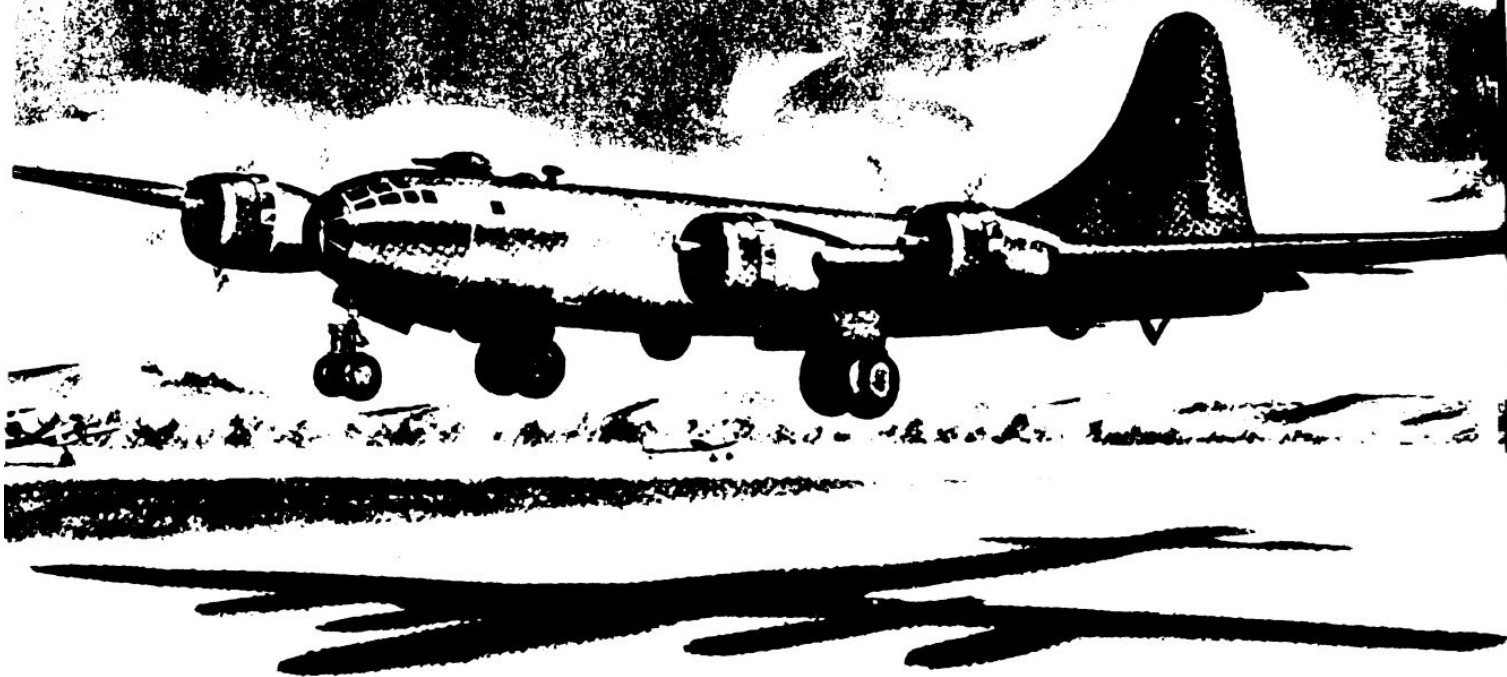

After Takeoff

1. Generators—Check While Gear Is Being Raised

As the gear is coming up, check the generators for amperage draw and paralleling.

2. Engine Check—Scanners' Report

Call the scanners and ask for their report on the condition of all engines. Be sure that your scanners are briefed to give an accurate report on color, type, and location of engine smoke, if it appears. See the diagram on engine fire recognition in the emergency section of this manual.

3. Cowl Flaps As Required

Adjust the cowl flaps to maintain CHT within limits (maximum opening 10° ; maximum CHT 260° for takeoff, 248° for climb). If a CHT rises above 260° on takeoff or stays above 248° after the first power reduction, report the condition immediately to the copilot: "No. ____ CHT ____" and open the cowl flaps on the hot

engine to a maximum of 10° . Never open the cowl flaps more than 10° in flight. If high cylinder temperature still persists, reduce manifold pressure or increase airspeed. Larger openings provide little additional cooling and decrease cruising range considerably. When you want to obtain maximum range, set the cowl flaps to the minimum opening to maintain desirable CHT. Don't exceed allowable CHT. Always report excessive CHT immediately to the copilot.

4. Putt-putt—Stop After Gear and Flaps Are Up

After flaps and gear are up have the operator stop the putt-putt.

5. Fuel Booster Pumps On LOW

6. Intercoolers As Required

Close the intercoolers when the turbos are off. When the copilot says: "Turbos off," you report: "Intercoolers closing."

Before Landing

1. Mixture Control—AUTO RICH

When ordered to prepare for landing place the mixture controls in AUTO RICH before increasing rpm.

Note: Place the mixture controls in AUTO RICH one at a time to avoid the possibility of inadvertently placing all four in FUEL CUT-OFF.

2. Putt-putt—Start and ON THE LINE

Ask the operator to start the putt-putt and when it is warmed up put in ON THE LINE.

3. Fuel Booster Pumps On LOW

Place the fuel booster pumps on LOW one at a time as a check on individual operation. Use the booster pumps within 1000 feet of field elevation or in the traffic pattern.

4. Hydraulic Pressures 1000 PSI

Check hydraulic pressures for proper reading. On the copilot's order check the emergency hydraulic pressure. If the pressure is not within the normal range of 900 to 1075 psi, open the emergency servicing valve. Re-service, if necessary, with the emergency over-ride switch. Report to the copilot: "1000 psi."

5. Pitot Heaters As Required

6. Anti-Icers As Required

7. De-Icers OFF

8. Wheel Well Lights (Night) ON

9. Generators Checked While Gear Is Coming Down

As the gear is coming down check the output of the generators to see that all of them are working, and that the load is equally distributed.

10. Cowl Flaps As Required

When the airspeed is reduced (175-180 mph) to lower the gear, set the cowl flaps as desired to maintain CHT.

11. Intercoolers Open To 7½°

Intercoolers are full open when the indicators show 15°.

12. Inverter Voltage Checked

13. Flight Engineer's Report—Gross Weight _____ lbs., Putt-putt ON LINE, Ready To Land.

The copilot asks for the engineer's report. When your checklist is completed report: "Gross weight _____ lbs.; putt-putt ON THE LINE; ready to land."

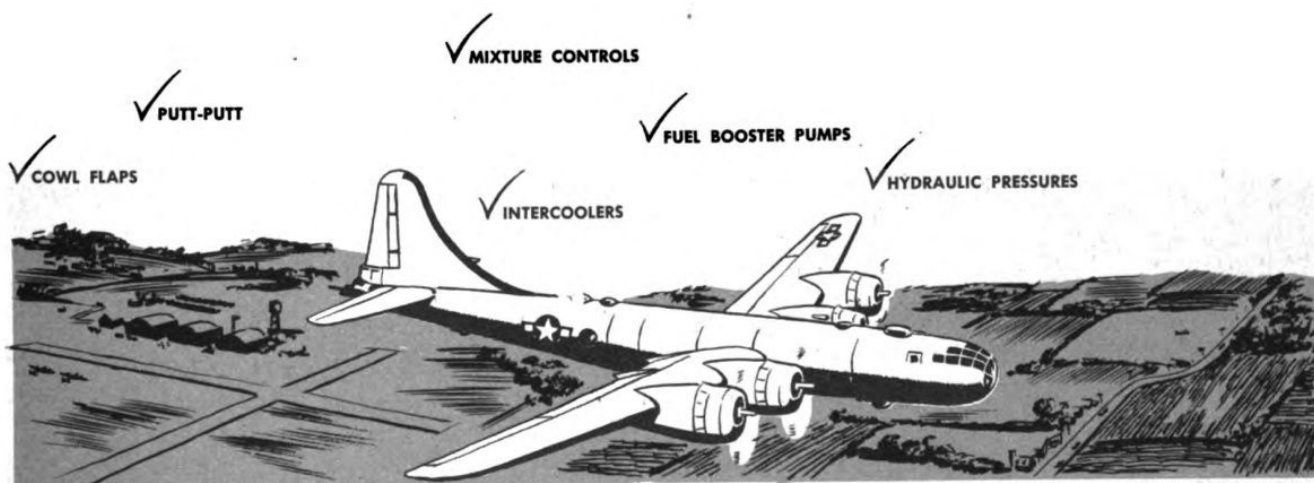

After Landing

1. Cowl Flaps Full OPEN

Move the cowl flaps to full OPEN position as soon as the nosewheel touches the ground and it is apparent that the airplane will remain on the ground.

2. Generators OFF

With Curtiss Electric propellers leave the generators ON until propeller pitch returns to normal.

3. Hydraulic Pressures Checked

Immediately after the wheels contact the runway check hydraulic pressures. If either pressure is low report the reading to the copilot and service the system.

4. Fuel Booster Pumps OFF

5. Engine Run-up Completed

When the copilot calls for the magneto check set the throttle on the engine to be checked to 2200 rpm and call out the manifold pressure to the copilot. Check the magnetos and report: "Checking magnetos, No. 1, right—both—left—both," etc.

6. Stop Engines—FUEL CUT-OFF

Use the following procedure to stop the engines after the airplane commander orders, "Cut engines."

a. Run carburetor-type engines at 700 rpm (800 rpm on fuel-injection engines) until CHT's drop (to 190° C, if possible). While the engines are cooling move the master ignition switch to OFF position momentarily to see that all magnetos are grounded out.

b. Increase the throttle settings to 1200 rpm and run the engines (either type) for at least 15 seconds at this speed to scavenge oil from the sumps and prevent liquid locks at the next pre-flight. Dilute the oil at this time if necessary.

c. Move the mixture controls to FUEL CUT-OFF.

d. As the engines die, close the throttles gradually and completely. Do not open the throttles to clear the engines.

e. After the propellers stop turning cut the magneto switches.

f. On fuel-injection engines place the throttles in closed position after the propellers stop turning.

7. All Switches OFF

8. Putt-putt OFF

Order the operator to stop the putt-putt.

9. Wheel Chocks In Place

10. Down Locks (Gear and Bomb Door) In Place

11. Pitot Covers In Place

12. Forms 1, 1A, Flight Log Completed

13. Give Crew Chief Report Of Malfunctions

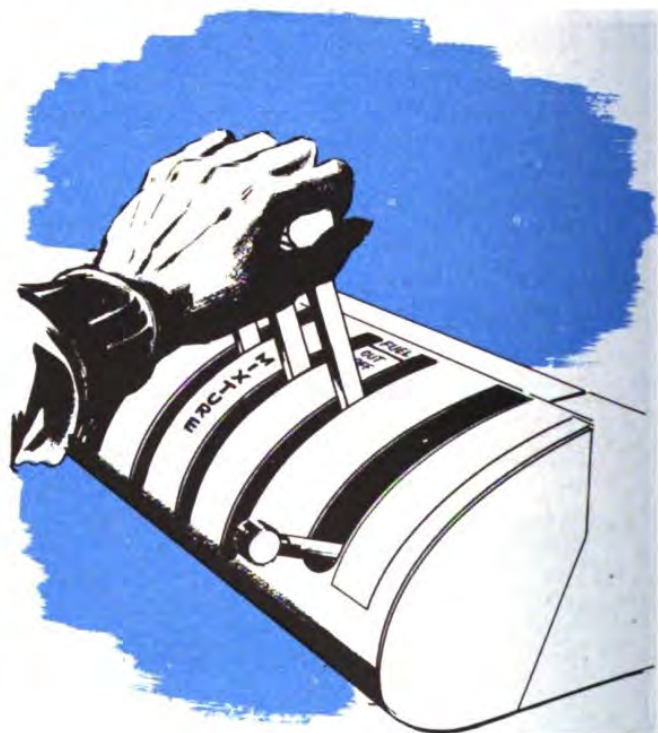

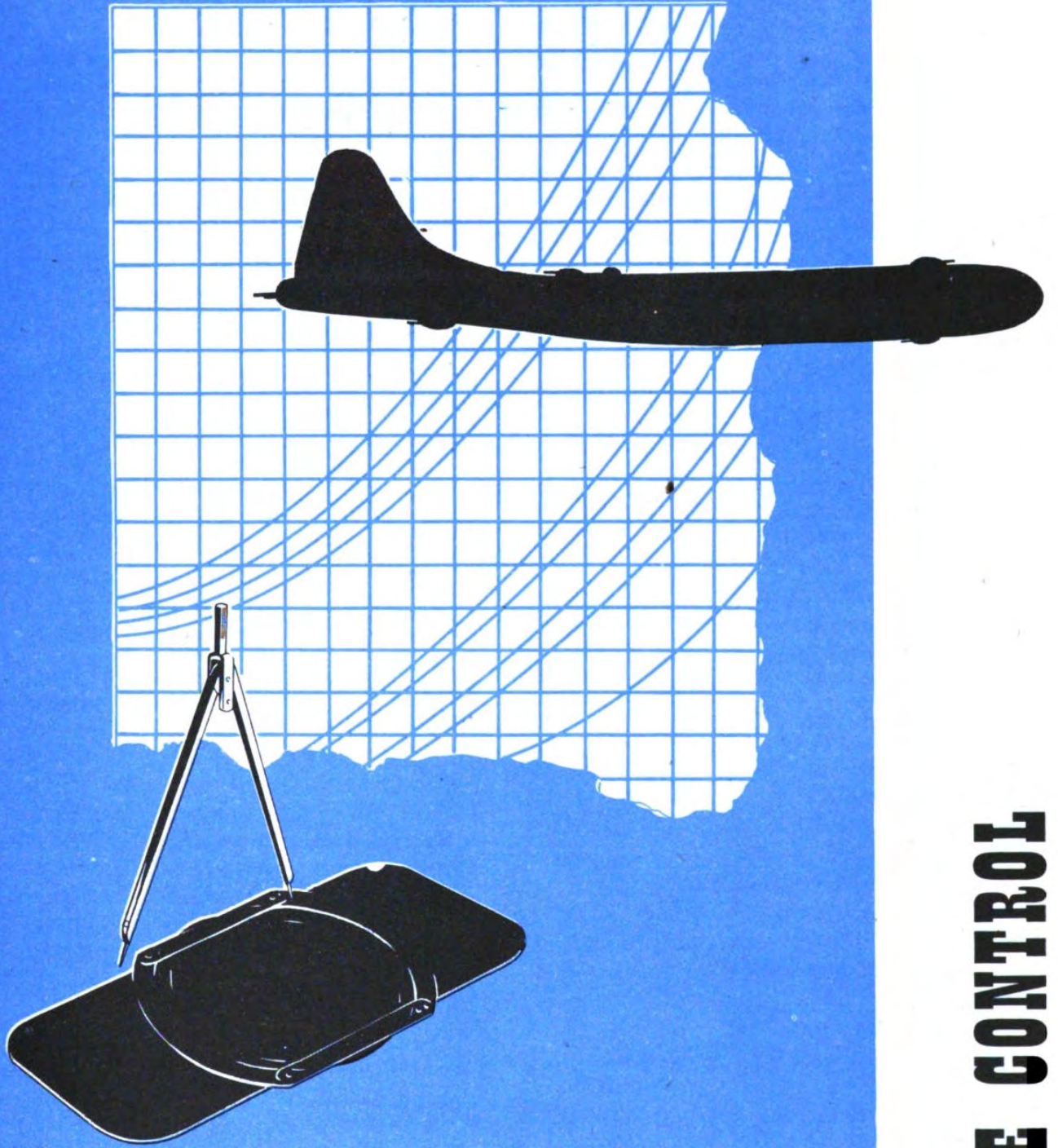

CRUISE CONTROL

Cruise control is the planned operation of aircraft before, during, and after flight. Its purpose is to obtain optimum performance from an airplane under any existing set of circumstances, due consideration being given to bomb and fuel load, length and type of mission, crew capability, winds and temperatures, and to limitations or restrictions on airframe, engines, propellers, and accessories.

As cruise control extends the range of the airplane, so does it amplify the duties and responsibilities of the flight engineer. Working closely with the airplane commander and the navigator, he must base his operations on calculations derived from a fairly complicated series of performance charts and curves. Complete proficiency in the use of the charts and curves will be attained only by understanding them and working with them. Conscientious study of the pages to follow, and of Appendix I-A of T.O. AN 01-20EJA-1 is essential.

Obviously, the term "Cruise Control" cannot be applied exclusively to any single operation. Actually, it consists of six interrelated operational steps, as follows:

1. Predicted flight progress curves;
2. Preflight planning;
3. In-flight operations;
4. In-flight replanning;
5. Operations after failure of one or more engines;
6. Post-flight analysis.

These steps are founded on a series of performance curves and charts. Since these charts, and the use of them, are basic to the other operations, they will be discussed first. However, before considering the charts and curves at length, let's have a brief explanation of calibrated airspeed, nautical miles, effect of cooling flaps, and engine operation, since doing so will make certain features of the charts and curves more readily understandable.

Calibrated Airspeed

Calibrated airspeed, that is, indicated airspeed corrected for position and instrument error, is always used on the B-29 for the following reasons:

1. In formation flying airplane speed is crit-

ically important, especially at high altitudes. Too high an airspeed makes it difficult for Tail-end Charlie to keep up; too low an airspeed causes inefficient flying. If different airplanes were to lead formations on a basis of indicated airspeed, speed of the formations would vary from day to day.

2. Rendezvous with other squadrons and with fighter groups demands close timing. This cannot be obtained if the various formations operate on indicated airspeed.

3. When operating with calibrated airspeed, all crew members concerned use the same speed in their calculations. With indicated airspeed, differences in instruments give different apparent speeds, resulting in confusion.

Nautical Miles

The nautical mile (6080 feet) rather than the statute mile (5280 feet) is used on all cruise control charts and curves in which distance is a factor. This is consistent with the use of nautical miles in all B-29 theatres of operation, and eliminates the possibility of confusion between the flight engineer and the navigator. It must be noted, though, that calibrated airspeed is read in terms of statute miles, since the instruments themselves are thus marked.

Effect Of Cooling Flaps

The drag of a B-29 does not remain constant—it is affected by altitude, speed, and several other factors. Important among the latter is the position of the cooling flaps.

The oil coolers normally operate between $\frac{1}{4}$ and $\frac{2}{3}$ open, and do not influence drag appreciably. The intercoolers, however, cause considerable drag. When open from 0° to $7\frac{1}{2}^\circ$ they reduce speed from 1 to $1\frac{1}{2}$ mph; when open from $7\frac{1}{2}^\circ$ to 15° they slow the airplane about 4 mph.

Cowl flaps present a serious drag problem. Opening the cowl flaps 6° reduces speed about 10 mph. During hot-day operation at altitude, large cowl flap openings are necessitated, and their drag will cause a considerable reduction in range. Consequently, the amount of cowl flap opening required (predicted cowl flap angle) must be considered in planning.

Engine Operation

For any given set of conditions, operation of the engine itself is very important. With constant speed propellers and turbo superchargers, it's possible to maintain constant power by lowering rpm and increasing manifold pressure, and vice versa. How then, is the proper setting determined?

Working pressure within the cylinders is roughly proportional to the manifold pressure. (This is the so-called brake mean effective pressure, abbreviated BMEP.) The higher the manifold pressure (and with it, higher BMEP), the lower the rpm required for the engine to develop a given amount of power. Fuel economy increases with BMEP, and so it would seem desirable to operate at the highest BMEP possible. At really high BMEP, however, engines are prone to detonate, and so a compromise must be made that will give good economy

plus satisfactory engine life.

As BMEP is increased and rpm reduced at a given power, propeller efficiency at cruising speeds tends to decrease. Because of the large propellers and the high propeller-engine speed ratio on the B-29, this decrease in efficiency is comparatively unimportant. Therefore, it pays to operate at the maximum limiting BMEP.

Curves and Charts

The curves and charts illustrated and explained on the following pages are samples taken from Appendix I-A of T.O. AN 01-20EJA-1. Curves and charts of similar form, but containing somewhat different values, may be available to fit the particular climatic conditions existing in various theatres.

The complete set of the curves and charts that are actually to be used for flight purposes will be found in Appendix I and I-A of T.O. AN 01-20EJA-1.

LONG RANGE PREDICTION CURVES, TYPE A-3-4

The curves are used for preliminary flight planning, and show the relationship between change in gross weight, time and distance. More specifically, the type A-3D-4 (distance) curve relates the change in gross weight caused by consumption of fuel with the distance traveled in that time.

The type A-3T-4 (time) curve gives the same relationship between change in gross weight, caused by fuel consumption, and time required for this change. Both are based on level flight at long-range speed and power setting, as sum-

marized on the type A-2-4 long-range summary curves.

Take a look at the sample curves. It will be seen that, if an airplane is flying at an altitude of 10,000 feet, reduction of gross weight from 100,000 to 90,000 by burning 10,000 lbs. of fuel gives the following:

Distance covered—4680 minus 3530, or 1150 miles;

Time required—22.4 minus 16.5, or 5.9 hours.

Dividers can be used to measure distance or time directly.

SAMPLE
LONG RANGE PREDICTION CURVE—DISTANCE
TYPE A-3D-4

4 ENG.
(CRUISING CONDITIONS PER TYPE A-2-4 CURVES)

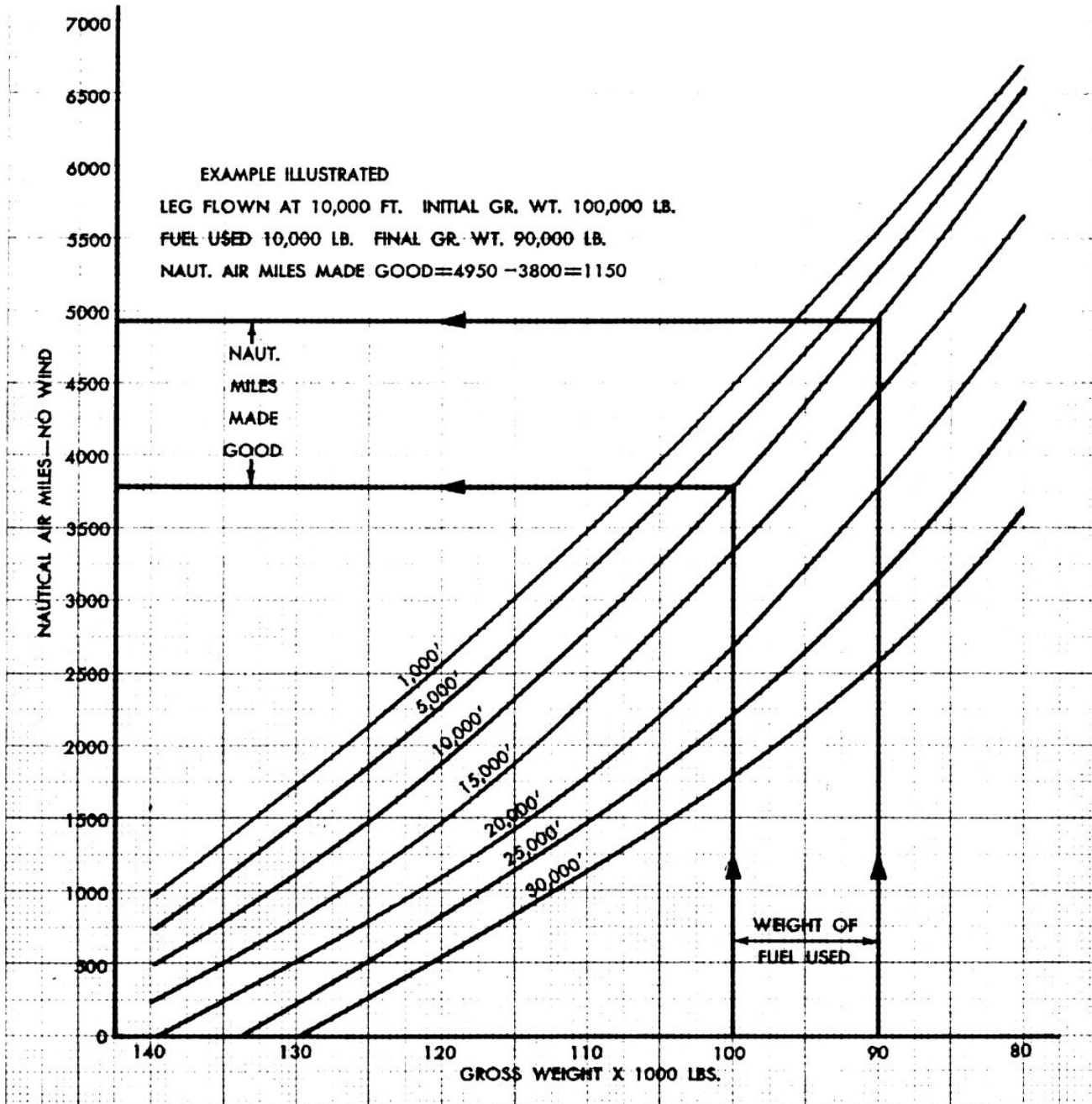

SAMPLE
LONG RANGE PREDICTION CURVE—TIME
TYPE A-3T-4

4 ENG.
(CRUISING CONDITIONS PER TYPE A-2-4 CURVES)

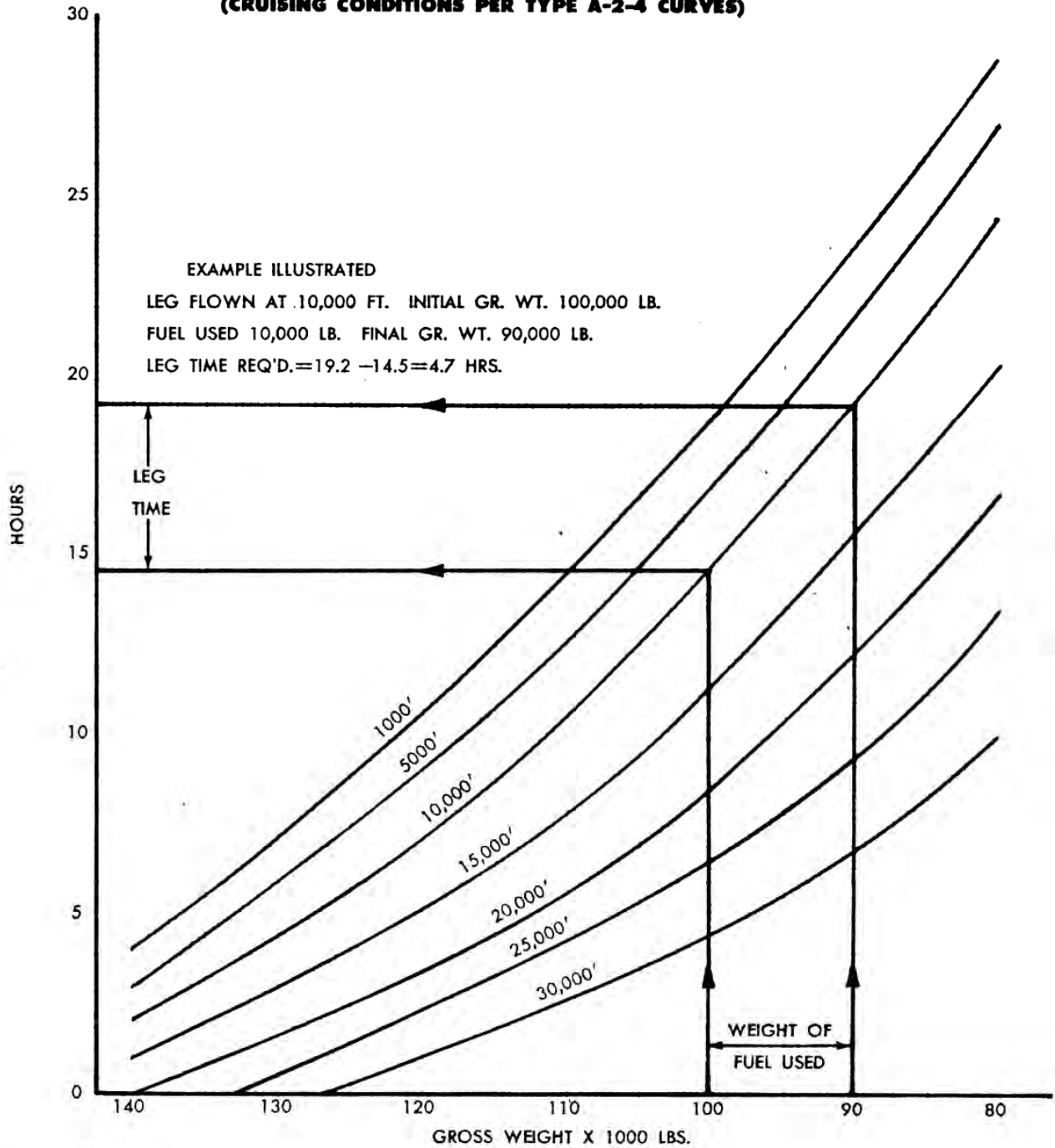

LONG RANGE SUMMARY CURVE, TYPE A-2-4

Curves of this type are used for preliminary flight planning of long-range cruise. The information is summarized from the type A-1-4, miles-per-gallon curves, since most operation of the B-29 is long-range cruising. This set of curves shows the direct relationship between long-range cruising speeds, rpm, miles per gallon, and predicted cowl flap angle at various gross weights and altitudes.

For example, the curve shown indicates that if an aircraft of 100,000 lbs. gross weight is flying at 20,000 feet, its calibrated airspeed should be 180 mph, rpm should be 2000, and the predicted cowl flap angle $3\frac{1}{2}^{\circ}$. Solid lines indicate auto lean mixture. Approximate nautical miles per gallon for the above conditions—0.600.

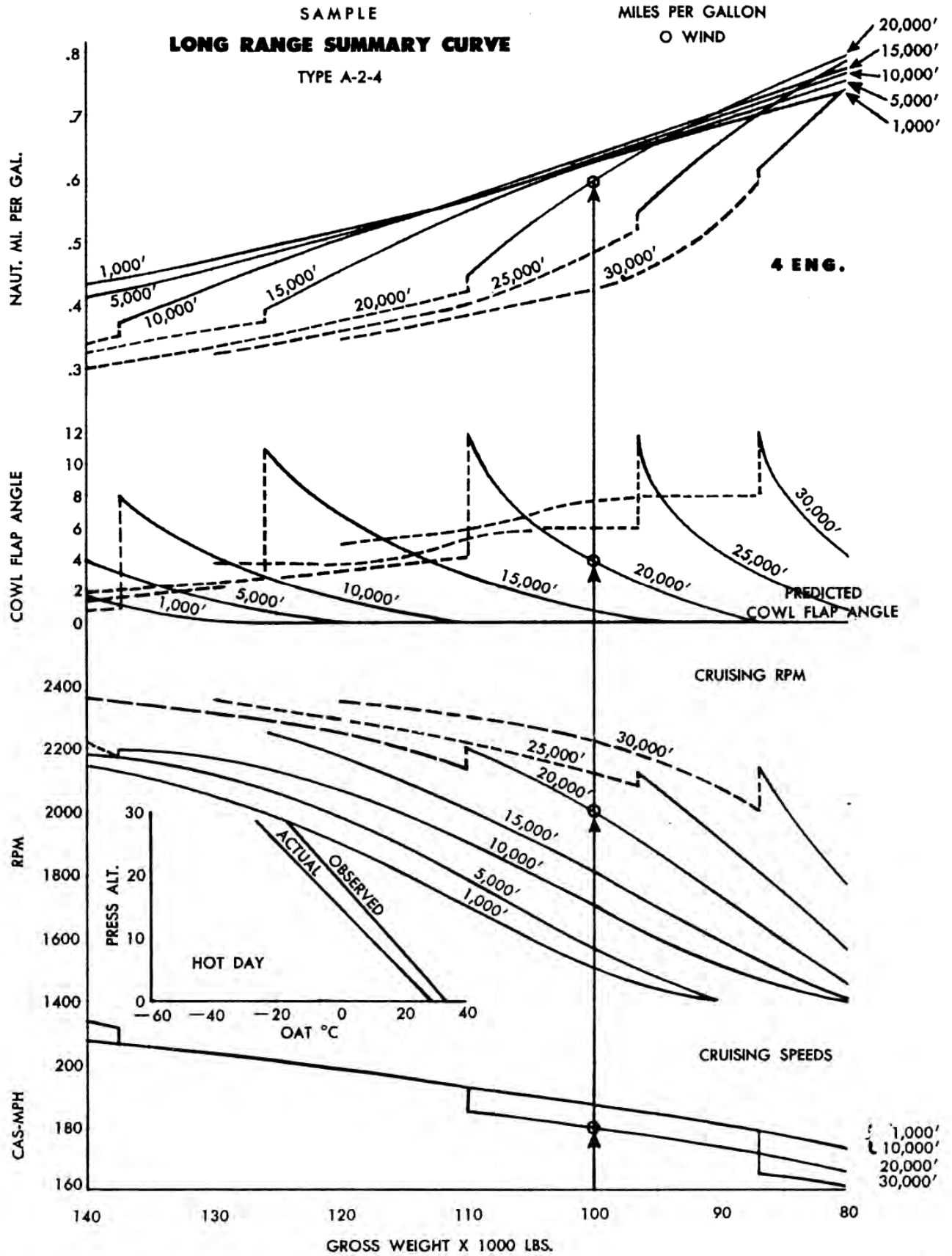

EMERGENCY MAXIMUM RANGE SPEED TABLE, TYPE A-4-4

This is a supplementary table giving maximum-range calibrated airspeeds for various gross weights and altitudes, at different wind velocities. The maximum-range calibrated airspeeds derived from this table are to be used when fuel is at a premium. Remember, though, that this table does not correct for loss of range caused by headwind, but simply gives the most efficient speeds to use in various wind conditions.

By comparing this table with the Long Range Summary Curve, Type A-2-4, it will be seen that the tabulated speeds for emergency maximum-range (with zero wind) are lower than the recommended long-range cruising speeds. Range is approximately 1% greater at these lower speeds, but stability is reduced slightly and flight time is, of course, increased.

**B-29 AND B-29A EMERGENCY MAXIMUM RANGE
SPEED TABLE, TYPE A-4-4 • FOUR ENGINES**

WEIGHT LBS.	ALTITUDE FT.	CALIBRATED AIRSPEED FOR MAXIMUM RANGE—MPH				
		HEADWIND KNOTS			TAILWIND KNOTS	
		100	50	0	50	100
120,000	30,000	197R	193R	190R	187R	186R
	20,000	200R	195R	190R	187R	185R
	10,000	202	191	186	183	181
	1,000	218	197	188	183	180
110,000	30,000	194R	190R	187R	185R	184R
	20,000	192R	189R	186R	183R	181R
	10,000	200	187	180	177	174
	1,000	216	191	182	177	173
100,000	30,000	190R	186R	183R	181R	180R
	20,000	181	176	172	168	167
	10,000	199	183	175	170	168
	1,000	214	186	175	170	166
90,000	30,000	168R	163R	160R	158R	157R
	20,000	179	171	165	161	157
	10,000	197	177	168	163	161
	1,000	211	182	172	166	162
80,000	30,000	163	156	150	150	150
	20,000	176	168	162	157	153
	10,000	195	170	160	156	154
	1,000	205	179	170	164	160

VALUES MARKED "R" REQUIRE AUTO RICH SETTINGS

RESTRICTED

BMEP POWER SCHEDULE, TYPE M-1

The purpose of this curve is to indicate the best manifold pressure to be used with different rpm settings at various altitudes and carburetor air temperatures.

The example illustrated on the curve on the opposite page shows that 32" Hg should be used at 2050 rpm, auto lean mixture, altitude 1000 feet, with a CAT of 25°C. With these settings, the BHP per engine will be 1250. The sample curve on page 95 is for use in temperate conditions.

Use of manifold pressures higher than those indicated by the curve may lead to detonation and shorter engine life; lower pressures mean less efficient use of fuel. These curves express the best balance between cruising range and satisfactory engine life.

The BMEP Power Schedule Table, Type M-1, is a tabulation of the information given on the type M-1 curves, and is used in the same manner. The figures on the table are based on a CAT of 25°C.

**MANIFOLD PRESSURE REQUIRED WITH ALTITUDE • 25° CAT
R-3350 ENGINE AND B-31 TURBOS**

RPM	*BHP	BMEP	1000'	5000'	10,000'	15,000'	20,000'	25,000'	30,000'	35,000'
2800			49.0	49.0	49.0	49.0	49.0	49.0	49.0	49.0
2600			47.5	47.5	47.5	47.5	47.5	47.5	47.5	47.5
2400	2000	197	42.0	41.2	40.6	40.3	40.2	40.2	40.3	40.4
2350	1880	189	40.1	39.2	38.5	38.1	38.1	38.1	38.2	38.4
2300	1760	181	38.5	37.3	36.6	36.2	36.1	36.1	36.2	36.4
2250	1650	173	36.7	35.1	33.9	33.4	33.2	33.2	33.3	33.5
2200	1540	166	35.4	34.1	33.1	32.6	32.4	32.4	32.6	32.8
2150	1435	159	34.2	32.7	31.7	31.0	30.8	30.8	30.9	31.3
2100	1340	151	33.0	31.6	30.4	29.7	29.4	29.3	29.4	29.8
										2100
2050	1250	144	31.8	30.2	29.0	28.2	27.8	27.8	29.0	28.0
										2050
2000	1190	140	31.3	29.7	28.7	27.7	27.0	26.9	27.1	27.2
										2050
1900	1130	140	31.3	29.6	28.0	27.3	26.7	26.8	27.0	26.0
1800	1070	140	31.2	29.6	28.0	27.3	26.6	26.7	27.0	
							1750	1750	1800	
1700	1010	140	31.2	29.6	28.0	27.3	26.2	26.0	25.8	
						1700	1700	1750	1750	
1600	950	140	31.2	29.6	27.8	26.0	25.6	24.8	25.2	
						1650	1650	1750	1700	
1500	890	140	31.1	29.3	27.8	25.6	25.0	23.7	24.5	
						1600	1600	1700	1700	
1400	830	140	30.8	29.2	27.8	24.8	24.1	23.0	23.5	
						1550	1600			
1400	770	130	29.6	28.0	26.2	24.00	22.8			
							1550			
1400	710	120	28.2	26.6	24.6		22.1			
							1550			
1400	650	110	27.1	25.3	23.1	22.7	21.2			
1400	590	100	25.9	24.2	21.7	21.2	20.9			

NOTE: Where RPM and MAP settings are both given, those settings are to be used to obtain the recommended power* where normal power settings will be limited by closed waste gates or surge.

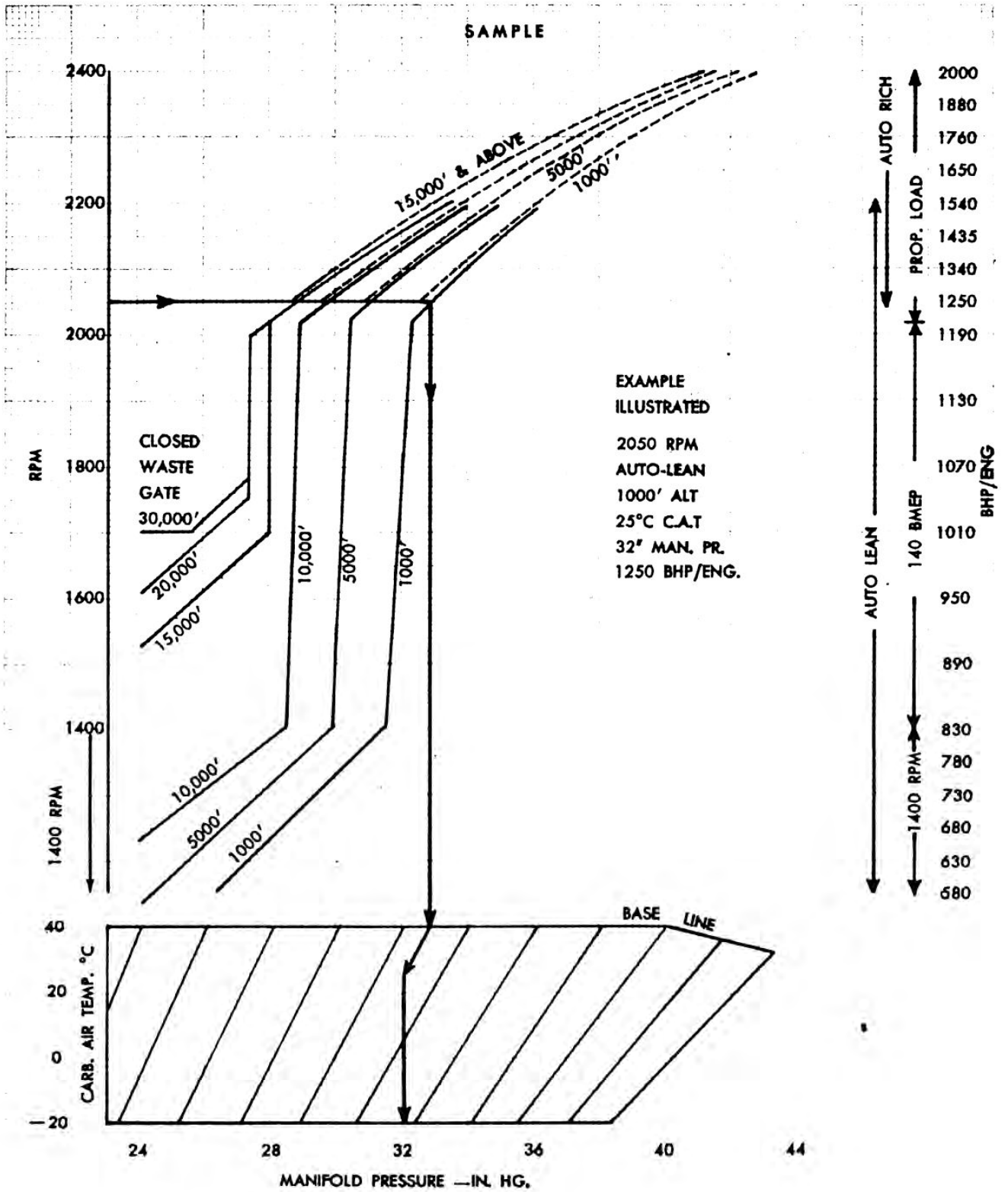

B M E P—POWER SCHEDULE
 (TEMPERATE CONDITIONS)

TYPE M-1

FUEL FLOW CURVES, TYPE M-2**Type M-2L — Auto Lean****Type M-2R — Auto Rich**

These curves can be used to estimate 4-engine fuel flow for various conditions of rpm, manifold pressure, altitude, and CAT. They are primarily useful when a deviation is made from the BMEP Power Schedule, Type M-1, such as might occur when flying formation. They are also used in post-flight analysis.

For the sake of clarity, separate curves for auto lean and auto rich operation are presented in Appendix I-A of the T.O.

The example illustrated herewith on the type M-2L curve shows auto lean operation at 1800 rpm, manifold pressure 28" Hg, altitude 10,000 feet, and CAT 20°C. Under these conditions, it can be read from the curve that the 4-engine fuel flow will be 327 gallons per hour.

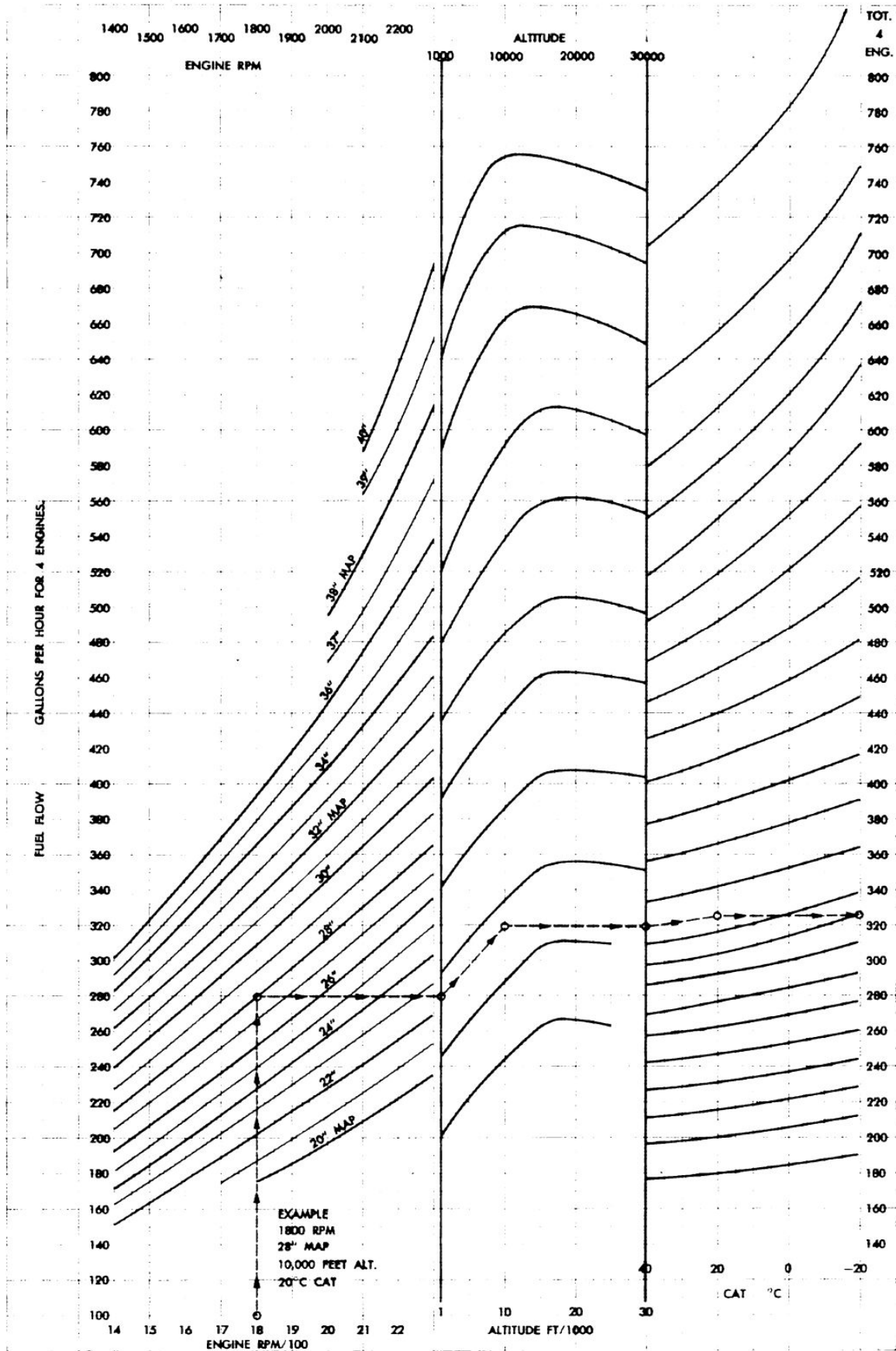

NAUTICAL MILES PER GALLON CURVE, TYPE A-1-4

Curves of this type present a picture of the relationship between miles per gallon, calibrated airspeed, altitude, gross weight, power settings, and predicted cowl flap angle for specified outside air temperatures. They also supply data for cruise other than long range, high speed cruise, constant speed or constant power cruise, maximum range, and maximum endurance. Similar curves have been prepared for 3- and 2-engine operation (3-engine: Type A-1-3, 2-engine: Type A-1-2).

Normal long-range cruise data taken from these curves are summarized on the Type A-2-4 Long Range Summary curves, previously discussed.

To illustrate the amount of information which may be obtained from the type A-1-4 curves, study the examples illustrated in connection with the text. An altitude of 25,000 feet, tropical conditions, and a gross weight of 90,000 lbs. are assumed. Inspection of the sample curves, at the points noted, will show:

1. Speed at rated power. This is read from the lower end of the curve for each weight. For example, at point A, 2400 rpm gives 233 mph CAS, 308 knots TAS, with a fuel consumption of .34 miles per gallon.

2. Speed at maximum cruise in auto lean. It can be seen at point B that with limiting 12°

cowl flap angle, operating in auto lean, rpm is 2170, CAS is 190 mph, TAS is 249 knots, and the miles per gallon value is .525.

3. Long-range cruising (about 99% maximum miles per gallon assumed). Study of the curve at point C shows the recommended long-range speed to be 172 mph CAS (228 knots TAS); obtaining this value requires 1925 rpm at a fuel consumption rate of .66 miles per gallon.

4. Emergency maximum range (no wind). From the curve at point D it may be seen that the maximum miles per gallon is .67. This requires 1780 rpm outboard and 1800 inboard, with a speed of 160 mph CAS (211 knots TAS). This speed may also be read from the type A-4-4 emergency maximum-range speed table.

5. Maximum endurance. Conditions for maximum endurance are read from point E, where the weight curve is tangent to the sloping rpm curve. For example, maximum endurance conditions for the assumed altitude and gross weight are seen to be 1750 rpm outboard and 1800 rpm inboard, and 150 mph CAS (200 knots TAS). This setting gives a miles per gallon value of .66. It should be noted that maximum endurance gives less miles per gallon as well as less speed than either long-range cruising or emergency maximum-range settings.

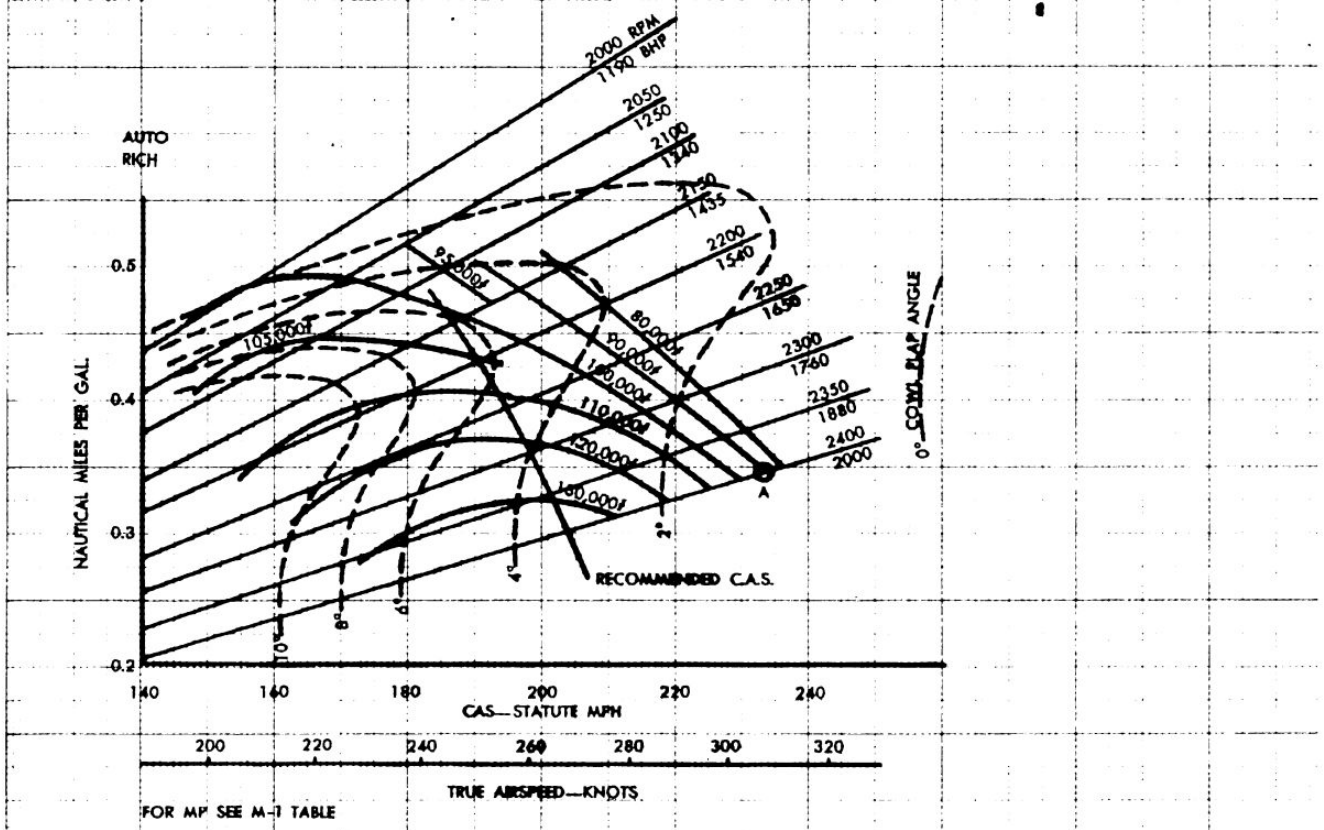
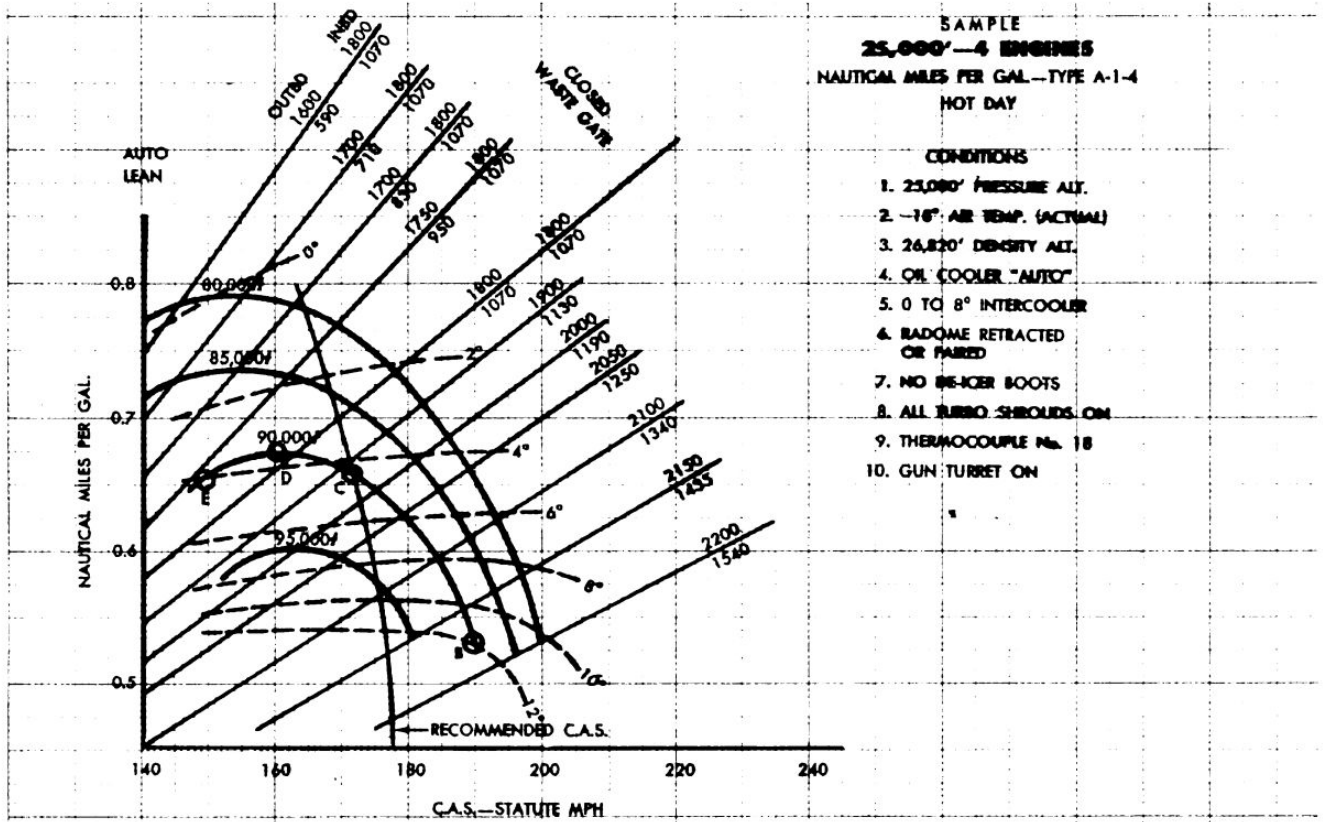

TAKEOFF DISTANCE CURVE, TYPE A-5

This chart gives the minimum distance required to clear a 50-foot obstruction under various conditions of temperature, pressure altitude, weight, type of runway surface, and wind. Ground run will average about 70% of the distances read from the chart. Recommended takeoff speeds are noted on the weight lines. The example illustrated on the chart indicates that with a ground temperature of 35°C and pressure altitude of —500 feet (barometer reading 30.5"), 115,000 lbs. gross weight and 120 mph takeoff speed, runway surface of short grass and effective headwind of 12 mph, the total distance required to take off and clear a 50-foot obstacle is 4700 feet, using 25° of wing flaps. Ground run would be 70% of 4700, or about 3300 feet.

The Galcit conversion table on the chart is used to obtain density altitude from pressure altitude and observed temperature.

CLIMB CONTROL CURVES, TYPE A-6

This type curve gives time, approximate fuel and distance required for climb to altitude at various weights, and is based on climb at constant 2000 hp. Fuel requirement as read from this curve does not include allowances for warm-up, taxiing, and takeoff.

For example, if gross weight is 120,000 lbs., a climb from 14,000 feet to 25,000 feet at 200 CAS and NACA standard temperature will take about 29 minutes, 580 gallons of fuel, and 120 air miles.

Corrections are available for climb at other powers and other temperatures. Since the climb of the B-29 is sensitive to outside air temperature, these corrections should always be used. Also, a table in Appendix I-A of the T.O. makes it possible to correct for drag variations caused by changes in external configuration.

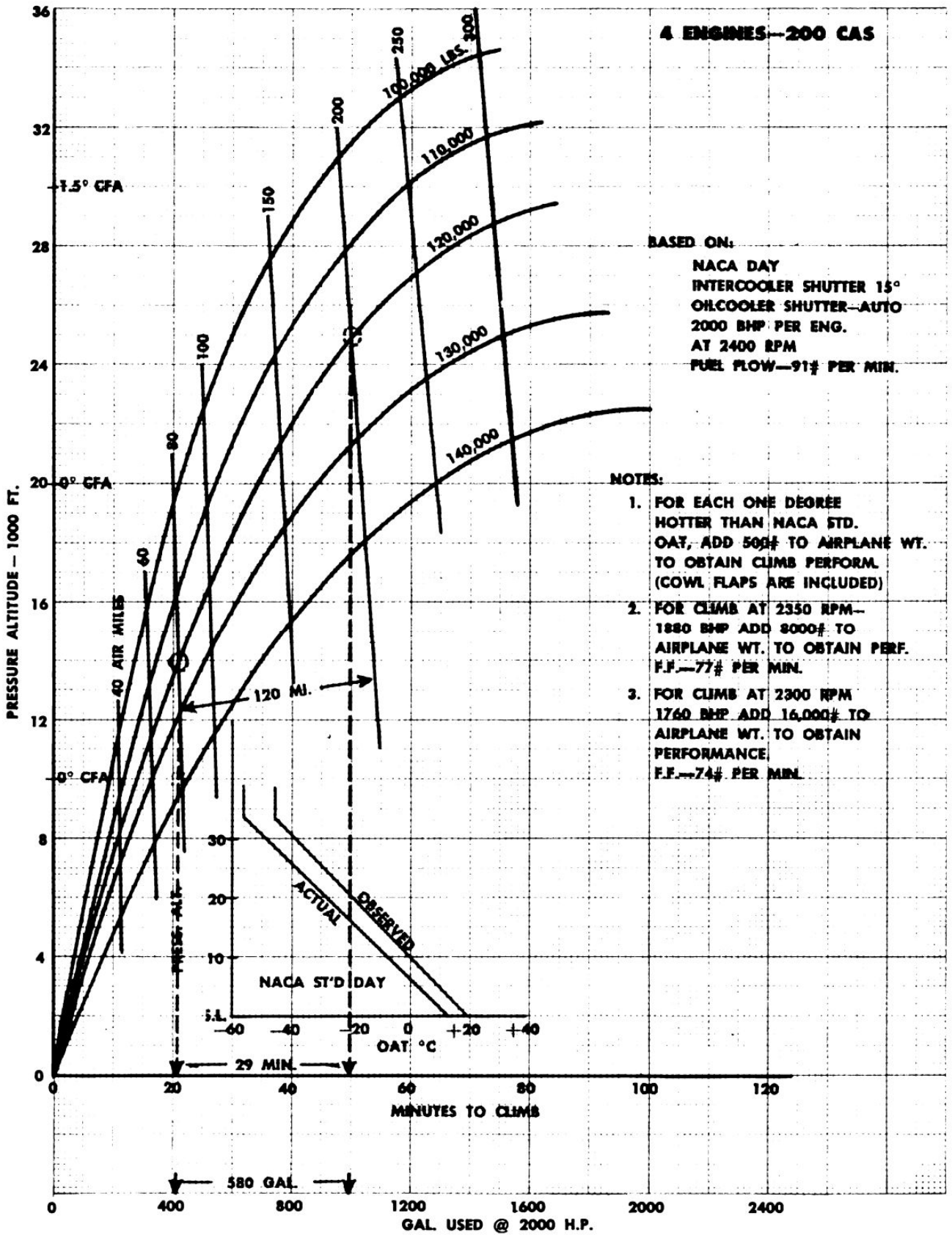

DESCENT CONTROL CURVE

Curves and charts giving distance traveled and fuel consumed in descent have been discontinued. Descents are made at long-range cruise speeds with reduced power. The distance gained in descent may be calculated approximately, or considered as extra reserve. One rule of thumb is to add about 2.2 nautical miles additional range for each 1000 feet of descent. For example, descent from 25,000 feet to sea level will add about 55 miles to the range.

TAKEOFF, CLIMB AND LANDING CHART

Made up on the standard AN form, this chart combines a tabulation of takeoff distances, climb data, approach speeds, and landing distances. It is included in Appendix I of the T.O., and is primarily intended to be used in staff planning.

FLIGHT OPERATION INSTRUCTION CHARTS

These charts are made up on standard AN forms and comprise tabulations of cruise control data for maximum range, maximum continuous, and three intermediate cruising conditions. Included in Appendix I of T.O. AN 01-20EJA-1, they are intended primarily for use in staff planning and in-flight replanning.

The Flight Operation Instruction Charts are convenient for the airplane commander to use as a rapid check on the flight engineer's predictions. For example, at 100,000 lbs. gross weight, carrying 3666 gallons of fuel of which 600 gallons is deducted as reserve, the maximum range on the remaining 3066 gallons is shown in Column V to be 1970 nautical (2270 statute) miles. If operation is to be at an altitude of 10,000 feet, power settings will be 1680 rpm, 27.9" Hg manifold pressure, mixture auto lean. The chart further shows that these settings give a speed of 216 mph TAS (188 knots), with a fuel consumption rate of 301 gallons per hour.

Because the Flight Operation Instruction Charts express values for the high end of each 10,000 weight increment, the total range given is slightly conservative compared with the engineer's figures as read from the type A-3-D4, Long-Range Prediction Curve.



AFMC-528 4-1-44		AIRCRAFT MODEL (S) B-29 & B-29A				SAMPLE FLIGHT OPERATION INSTRUCTION CHART FOR TROPICAL CONDITIONS				EXTERNAL LOAD ITEMS NONE					
ENGINE (S): R-350-25A		CHART WEIGHT LIMITS: 100,000 TO 90,000 POUNDS				NUMBER OF ENGINES OPERATING: FOUR (4)									
LIMITS	RPM	M.P. IN.-HG.	MIXTURE POSITION	TIME LIMIT	CYL. TEMP.	TOTAL G.P.H.	INSTRUCTIONS FOR USING CHART: SELECT FIGURE IN FUEL COLUMN EQUAL TO OR LESS THAN AMOUNT OF FUEL TO BE USED FOR CRUISING AND MOVE HORIZONTALLY TO RIGHT OR LEFT AND SELECT RANGE VALUE EQUAL TO OR GREATER THAN THE STATUTE OR NAUTICAL AIR MILES TO BE FLOWN. VERTICALLY BELOW AND OPPOSITE VALUE NEAREST DESIRED CRUISING ALTITUDE (ALT.) READ RPM, MANIFOLD PRESSURE (M.P.) AND MIXTURE SETTING REQUIRED.				NOTES: COLUMN I IS FOR EMERGENCY HIGH SPEED CRUISING ONLY. COLUMNS II, III, IV AND V GIVE PROGRESSIVE INCREASE IN RANGE AT A SACRIFICE IN SPEED. AIR MILES PER GALLON (MI./GAL.) (NO WIND), GALLONS PER HR. (G.P.H.) AND TRUE AIRSPEED (T.A.S.) ARE APPROXIMATE VALUES FOR REFERENCE. RANGE VALUES ARE FOR AN AVERAGE AIRPLANE FLYING ALONE (NO WIND) TO OBTAIN BRITISH IMPERIAL GAL. (OR G.P.H.): MULTIPLY U.S. GAL. (OR G.P.H.) BY 10 THEN DIVIDE BY 12.				
							STATUTE	NAUTICAL	U.S. GAL.	RANGE IN AIRMILES	STATUTE	NAUTICAL	U.S. GAL.	RANGE IN AIRMILES	STATUTE
WAR	2800	50.5	AR	5	260	1320	1600	1800	2070	2260	2520	2180	3000	2600	
EMERG.	2800	50.5	AR	5	260	1320	1600	1800	2070	2260	2520	2180	3000	2600	
MILITARY	2600	47.5	AR	5	250	1200	1500	1700	1900	2100	2300	1900	2500	2100	
POWER	2600	47.5	AR	5	250	1200	1500	1700	1900	2100	2300	1900	2500	2100	
<p>INSTRUCTIONS FOR USING CHART: SELECT FIGURE IN FUEL COLUMN EQUAL TO OR LESS THAN AMOUNT OF FUEL TO BE USED FOR CRUISING AND MOVE HORIZONTALLY TO RIGHT OR LEFT AND SELECT RANGE VALUE EQUAL TO OR GREATER THAN THE STATUTE OR NAUTICAL AIR MILES TO BE FLOWN. VERTICALLY BELOW AND OPPOSITE VALUE NEAREST DESIRED CRUISING ALTITUDE (ALT.) READ RPM, MANIFOLD PRESSURE (M.P.) AND MIXTURE SETTING REQUIRED.</p>															
<p>EXAMPLE</p> <p>AT 95,000 LB. GROSS WEIGHT WITH 2000 GAL. OF FUEL (AFTER DEDUCTING TOTAL ALLOWANCES OF 600 GAL.) TO FLY 1430 STAT. AIRMILES AT 10,000 FT. ALTITUDE MAINTAIN 1680 RPM AND 29.9 IN. MANIFOLD PRESSURE WITH MIXTURE SET: AUTO LEAN FOR FIRST THREE HOURS THEN CHANGE TO SETTINGS SHOWN ON FOLLOWING PAGE</p>															
<p>SPECIAL NOTES</p> <p>(1) MAKE ALLOWANCE FOR WARM-UP, TAKE-OFF & CLIMB (SEE FIG.) PLUS ALLOWANCE FOR WIND, RESERVE AND COMBAT AS REQUIRED. BASED ON MARIANAS STD. DAY WITH 25° C CARB. AIR TEMP.</p>															
<p>LEGEND</p> <p>ALT. : PRESSURE ALTITUDE KTS. : KNOTS M.P. : MANIFOLD PRESSURE S.L. : SEA LEVEL-1000' GPH : U.S. GAL. PER HOUR A.R. : AUTO-RICH TAS : TRUE AIRSPEED A.L. : AUTO-LEAN</p>															

PREPARATION OF FLIGHT PROGRESS CURVES

After the flight plan is known, the predicted flight progress curves are prepared. These curves are used during the mission by the flight engineer and the airplane commander as a check between predicted and actual fuel consumption. Also, in case an engine is lost during flight, they enable the flight engineer to determine approximately the range that can be obtained with the remaining fuel aboard.

The Predicted Flight Curve is in effect a graphic log of the predetermined fuel requirements on the flight plan and the resultant fuel mileage obtained with those particular power settings. This curve is plotted from the various cruise control curves and charts included in Appendix I and I-A of T.O. AN 01-20EJA-1.

The Flight Progress Curve, usually referred to as the "how goes it curve," is a graphic plot of the fuel consumption and elapsed time during actual flight. The curve should be plotted at each change in power settings, and at 1-hour intervals between changes. Some difficulty may be experienced by flight personnel in plotting the curve during formation flying, when a certain amount of throttle-jockeying is required. Therefore the flight engineer makes a mental average of such variations.

The Flight Progress Curves (see page 112) are obtained as follows:

1. After the flight plan is completed, the fuel used during the period of operation following each power change is subtracted from total fuel. The time for each interval is obtained from the flight plan. These figures are then plotted on a fuel versus time chart, which is the predicted flight progress curve. Distance may also be plotted.

2. The "how goes it curve" is plotted during flight, and is shown as a dotted line. The plotting figures are obtained from the flight engineer's log. The entries of fuel used are subtracted from the total quantity and plotted against the total elapsed time.

3. It is a highly recommended procedure to plot a 3-engine operating curve in conjunction with the flight progress curve, and on the same

chart. This will enable the flight engineer to determine whether the reserve fuel is sufficient to permit an emergency 3-engine return to base. It will also indicate a "point of no return" if overconsumption of fuel or extreme headwinds are encountered. The "point of no return" is the distance beyond which loss of an engine will prevent the airplane from returning to the initial takeoff field, and will necessitate landing at an emergency field on the return.

The 3-engine operating curve is shown plotted. Fuel consumption data for 3-engine operation can be obtained from the curves in Appendix I-A, T.O. AN 01-20EJA-1.

Malfunctions as they occur in flight are described on the Aircraft Malfunction Report, as shown on page 114.

PREFLIGHT PLANNING

Thorough and conscientious preflight planning not only assures adequate fuel reserve but also reduces the amount of paper work necessary in the air. In general, preflight planning requires consideration of loading, altitude, weather, proper speeds, and power settings for each phase of the flight plan. Close coordination between the flight engineer, airplane commander, and navigator is required. It's worth taking the trouble to make every flight a well-planned one.

The curves and charts described in the preceding pages will be found most useful in the detailed planning of a flight and in preparation of the predicted flight progress curves.

The usual flight for a B-29 is a long-range bombing mission. Standard long-range cruise control procedures apply, and type A-2-4 Long Range Summary, A-3-4 Long Range Prediction, M-1 BMEP Power Schedule, and A-6 Climb Control Curves are most frequently used in planning. The Flight Operation Instruction charts furnish an excellent means of making a quick check on predicted fuel requirements.

Allowances must be made for ground operation (usually 3 gallons per minute for four engines, including taxiing and engine run-up), takeoff (usually 20 gallons per minute for four engines), climb, wind, combat, and unusable

fuel. Careful consideration must be given to the amount of close formation flying that will be done, since fuel consumption during formation flight may be increased by as much as 7%, depending on size of formation and technique of the airplane commander. Reserve fuel requirements will be dictated by local doctrine.

IN-FLIGHT OPERATION

Takeoff

You begin to use Cruise Control as soon as the engines are started. However, so little fuel is used during ground operations preceding takeoff that the fuel flow meters will not register. Therefore, although fuel flow meter readings should normally be used for accurate computation of fuel consumption, it is a practical expedient in the case of ground operation to assume a fuel flow of 3 gallons per minute and 20 gallons per minute for takeoff power, until initial climb settings are established.

The time lapse between engine starting and the beginning of the initial climb after takeoff is small—seldom greater than 15 minutes. Experience has shown that it's safe to predict a fuel consumption of approximately 100 gallons for this series of operations.

Climb

The duration of initial climb is governed by local terrain, weather, tactical requirements, and wind conditions. Best cruising results are usually obtained by staying low for as long as possible.

The flight engineer determines the quantity of fuel consumed by consulting the BMEP Power Schedule, Type M-1, and the Auto Rich Fuel Flow Chart, Type M-2R. It is a general rule in tactical operation to make all climbs at rated power.

As during takeoff, the flight engineer keeps a close watch over the engine instruments, and adjusts the cowl flaps to obtain minimum drag by maintaining maximum allowable cylinder-head temperatures.

After conditions are stabilized in the climb, the flight engineer should consult the flight plan and determine the initial cruise power setting.

Adjustments from the original predictions are frequently necessitated by variations in temperature, wind, and weather.

Cruise

Cowl flaps should be opened to hasten engine cooling, and closed gradually as cylinder-head temperatures recede. In case one engine is overheated, further cooling may be obtained by reducing its manifold pressure.

When cruising altitude is reached, cruising power and cylinder-head temperatures will generally be low enough to permit auto lean operation. The fuel savings obtainable by auto lean carburetor settings are great enough to warrant speed reductions of as much as 10 mph below maximum-range speeds, if adequate cooling can be maintained without excessive cowl flap opening.

The intercoolers, open during takeoff and climb, should be closed down in cruise if temperatures allow. Carburetor air temperature of 38°C is generally considered to be the maximum allowable. Extreme carburetor air temperatures tend to raise cylinder-head temperatures and reduce the power output for any given manifold pressure and rpm settings. On the other hand, very low carburetor air temperatures affect fuel distribution adversely and may cause carburetor icing. However, in the case of aircraft equipped with fuel injection systems, carburetor icing is unlikely and lower carburetor air temperatures are permitted, even under conditions of high humidity.

After cruise conditions have stabilized, the flight engineer may devote some time to bringing his logs up to date and calculating the next power setting. Power reductions should be made at least once every hour, maintaining long-range airspeeds.

Descent

Descents should always be made at long-range airspeed. Since most long-range flights are made with the airplane on AFCE, the rate of descent will be from 50 to 150 feet per minute. When necessary, power reductions will be made in accordance with the BMEP Power Schedule in order to maintain efficient and economical engine operation.

Under no-wind conditions, approximately 2.2 nautical miles of range can be gained for every 1000 feet of altitude. This is a small factor compared with the magnitude of winds at altitude. Consequently, wind conditions must be given primary consideration in making a descent.

When head winds are encountered it is best to descend rapidly through the regions of high adverse winds, and cruise at altitudes where wind conditions are more favorable.

Turbo Surge

Turbo surge is most frequently encountered during descent from altitude. Even a slight surge can cause large increases in fuel consumption, particularly with fuel injection engines. Corrective measures should be taken as soon as the surging becomes noticeable. (See section on **Turbo Surge**.)

Center of Gravity

Various tests performed with the B-29 have shown that the location of center of gravity, within allowable limits, has no appreciable effect on range or miles per gallon. Variations in the amount of drag are negligible so long as the airplane is kept in trim. However, ease of handling is increased by a slightly forward center of gravity position—somewhere around 25% MAC.

Manual Leaning

Manual leaning of the mixture, that is, operating with the mixture controls at any point between the auto rich and auto lean positions, is not recommended. Operating with the mixture controls between the auto lean and fuel cut-off positions is dangerous, and is expressly forbidden by T.O. 01-1-193.

Carburetor-equipped engines have only two fuel-air ratio settings—auto rich and auto lean. If, at any given manifold pressure and rpm setting, the mixture control is moved slowly from auto rich to auto lean and thence to fuel cut-off, the following sequence of events takes place.

1. Mixture remains constant until the control is about halfway between auto rich and auto lean.

2. As that point is passed, only a few more degrees of control movement causes the fuel-air ratio to shift suddenly to the auto lean condition.

3. The mixture again remains constant until the control reaches a point close to the fuel cut-off position.

4. Again, over a range of very few degrees of control travel, the mixture leans out drastically into the cut-off condition.

From this it may be seen that nothing will be gained by attempts to adjust the mixture between auto rich and auto lean. Adjustment between auto lean and fuel cut-off will cause the fuel-air mixture to fluctuate between lean and too lean, resulting in unequal distribution to the cylinders. When mixture distribution is unequal, one cylinder may receive so lean a mixture that the resultant slow flame travel permits a burning charge to remain in the combustion chamber throughout the exhaust stroke. When the intake valve opens for the next cycle, the flame ignites the charge in the induction system, causing either a backfire or unstable engine operation. At certain engine speeds and mixture velocities, continuous combustion in the induction system may ensue; this is known as an induction fire.

If the airplane were equipped with fuel flow meters and torque meters, adjustments might be made and a gain in range obtained, not by moving the mixture control to below the auto lean setting but by accurate control of the fuel flow. However, with the present two-position carburetors, operation must be limited to the fixed auto rich and auto lean settings.

Some airplanes are equipped with fuel injection systems. These also are designed to operate on two fixed mixture control settings, auto rich and auto lean. Manual adjustment of the mixture control to intermediate positions should not be attempted.

Unusable (Trapped) Fuel

Depending on the attitude of the airplane, varying amounts of fuel will be trapped in the tanks. These quantities are shown in the following tabulation:

RESIDUAL FUEL IN WING TANKS WHEN FLYING WITH WINGS LEVEL

FLIGHT ATTITUDE	TANKS 1 AND 4	TANKS 2 AND 3
Body CL* 4° up	21 gals. ea.	17 gals. ea.
Body CL 2° up	18 gals. ea.	17 gals. ea.
Body CL 0°	18 gals. ea.	23 gals. ea.
Body CL 2° down	18 gals. ea.	37 gals. ea.
Body CL 4° down	21 gals. ea.	55 gals. ea.
Body CL 6° down	27 gals. ea.	71 gals. ea.
Body CL 8° down	33 gals. ea.	86 gals. ea.
Body CL 15° down	70 gals. ea.	190 gals. ea.
Body CL 20° down	105 gals. ea.	268 gals. ea.

* Center Line

RESIDUAL FUEL IN CENTER TANKS WHEN FLYING WITH WINGS LEVEL

FLIGHT ATTITUDE	B-29A CENTER TANKS	B-29 CENTER TANKS	BOMB BAY TANKS
Body CL 2° up	0 gals.	17 gals.	3 gals. ea.
Body CL 4° up	1 gal.	24 gals.	9 gals. ea.
Body CL 0°	0 gals.	11 gals.	0 gals. ea.
Body CL 2° down	4 gals.	13 gals.	3 gals. ea.
Body CL 4° down	14 gals.	28 gals.	9 gals. ea.
Body CL 6° down	25 gals.	57 gals.	16 gals. ea.

RESIDUAL FUEL QUANTITIES FOR VARIOUS FLIGHT ATTITUDES WITH EITHER WING 2½° DOWN

FLIGHT ATTITUDE	Gals. TANK 1	Gals. TANK 2	Gals. TANK 3	Gals. TANK 4
Body CL 4° up	21	17	17	21
Body CL 2° up	18	18	16	18
Body CL 0°	18	32	14	18
Body CL 2° down	18	50	24	18
Body CL 4° down	21	72	38	21
Body CL 6° down	28	99	43	26
Body CL 8° down	36	121	51	30

IN-FLIGHT REPLANNING

Revision of the flight plan during a mission is often required by unpredictable adverse circumstances such as weather, navigational error, materiel failure, battle damage, or wounded crew members. The following steps are generally to be taken in revising the flight plan during a mission.

1. Find out from the navigator the time required for a return either to home base or to an alternate airfield, using maximum-range airspeeds. Get from him also the desired altitude for best wind conditions.

2. Determine usable fuel.

3. Determine fuel required for new plan.

4. Estimate the fuel reserve upon reaching destination.

5. Advise the airplane commander of the new flight plan, desired CAS and altitude, and approximate fuel reserve upon reaching destination.

Note: It is generally true that more fuel will be saved in evading adverse headwinds by descending to lower altitudes than by climbing to higher levels.

OPERATION ON LESS THAN FOUR ENGINES

The usual immediate steps of propeller feathering and airplane trimming should be taken when battle damage and materiel failure result in loss of power in one or more engines. As soon as the emergency is dealt with, the engineer must replan the flight, using the procedures outlined under **In-flight Replanning**.

By the use of the 3- or 2-engine miles-per-gallon curves, and after consultation with the navigator, a favorable altitude should be selected that will allow an auto lean power setting resulting in maximum-range airspeed. If the emergency is encountered before reaching target, the bomb load will be jettisoned or dropped on a target of opportunity. If the resulting gross weight does not allow auto lean operation at the existing altitude, descend to an altitude not lower than the minimum that will permit return to base without requiring

a later climb. Then fly at emergency maximum-range airspeeds until gross weight reduction is sufficient to permit the use of auto lean power settings.

This cruising altitude should be maintained at maximum-range airspeeds until the destination is reached, reducing power as required. Further descent is not recommended, since altitude is a safety factor in the event that additional loss of power occurs.

When cruising on two or three engines, keep all engines operating on the same power settings. Correct for unbalanced thrust by using the trim tabs.

All excess weight is usually reduced to a minimum before the start of a flight, all unnecessary items being removed to permit carrying the maximum load of bombs and fuel. Because of this, the amount of increased range that can be obtained on the return by jettisoning equipment (assuming that at least three engines are operating) is not encouraging.

It is true that range will be increased by jettisoning weight, but only to the extent of approximately .007 miles per gallon for each 1000 lbs. jettisoned. For example, if 2500 gallons remain in the fuel tanks, throwing 2000 lbs. of equipment overboard will increase the maximum range about .007 (2500) 2 miles, or 35 miles. From this it's easy to see that the amount of increased range depends on how early in the return flight equipment is jettisoned. If jettisoning is decided upon late in the flight, little can be gained by the loss of equipment at that time.

If two engines are lost on the return trip, jettisoning of equipment becomes of much greater importance. It can reduce weight sufficiently to permit level flight on two engines, and it will allow operation at more economical power settings toward the end of the flight.

POST-FLIGHT ANALYSIS

After completion of a mission, the airplane commander and the flight engineer must examine the flight progress curves for discrepancies. If large variations are found to exist between the actual and the predicted flight curves, an investigation should be made to

determine the cause. The flight curve should be compared with those of other airplanes that were on the same mission. The flight engineer's log should be carefully examined, and any indications of abnormal engine conditions noted in the remarks column. It is important to keep a record of the cruise performance of the airplane itself, with different crews and on various missions.

A report should be made to maintenance if an engine's fuel consumption is found to be abnormal. Remember, though, that abnormal fuel consumption is seldom caused by materiel malfunction. Consequently, before reporting to maintenance, it is advisable that the flight technique and the engineer's flight predictions be closely examined for errors by the staff flight engineer.

TIPS ON CRUISE CONTROL

1. Keep the airplane aerodynamically clean. Cowl flap openings should be closed so as to maintain maximum allowable cylinder-head temperatures. Inter-cooler flaps should be opened the smallest possible amount to maintain a desired CAT.
2. Develop crew coordination. Obtain ETA's and data on wind conditions from the navigator. Use winds effectively.
3. Operate at maximum allowable BMEP.
4. Reduce power settings every hour or whenever you feel that the desired CAS can be maintained at lower power.
5. Always check mathematical calculations of fuel consumption against the liquidometers.
6. Transfer fuel as soon after takeoff as possible. By doing so you will check the operation of the transfer units before reaching the "point of no return" of the wing tanks, prevent freezing of the units at altitude before completing transfer, and transfer fuel from bomb bay tanks before going over the target.

DATE 4 JULY 45 FUEL LOADING BASIC WT. 74,000 #
MISSION FIELD ORDER 00 ESTIMATE REQ'D. 3950 WING TANKS 455064 BOMB LOAD 17500 #
SQUADRON _____ RESERVES 600 CENTER WING 0 AMMUNITION 1500 #
FORM POSITION _____ TOTAL ABOARD 4550 BOMB-BAY 0 T.O. GROSS WT. 125000 #

- FLIGHT PLAN -

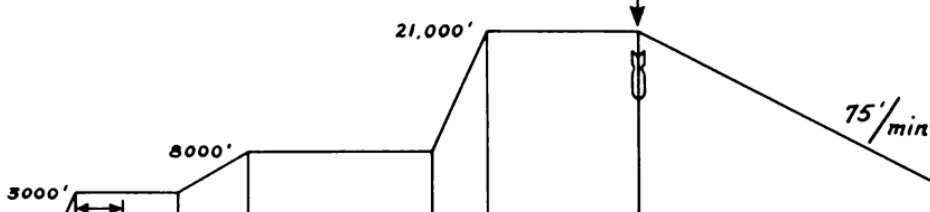

CONDITIONS	W.U. T.O. CLIMB	CRUISE	CLIMB	CRUISE	CLIMB	TARGET AREA	DESCENT TO BASE
GROSS WT.	123300	21500	120900	116500	113740	92,500	83,530
C.A.S.	200	200	200	198	200	194	176
TIME (HRS.)	.083	0.80	0.10	1.8	.38	0.9	4.65
TOT. TIME (HRS.)	.083	0.833	0.983	2.783	3.163	4.063	8.713
POWER	2400 43.5	2025 30	2400 41.5	2060- 29"	2400 41	2200 32.5	1825-27"
FUEL USED	270	313	100	733	460	623	1430
TOT. FUEL USED	270	583	683	1416	1876	2499	3929
DISTANCE	18	182	22	400	90	288	1000
TOT. DISTANCE	18	200	222	622	712	1000	2000

LOG COMPILED BY XXI B.C.
& USED BY XX A.F.

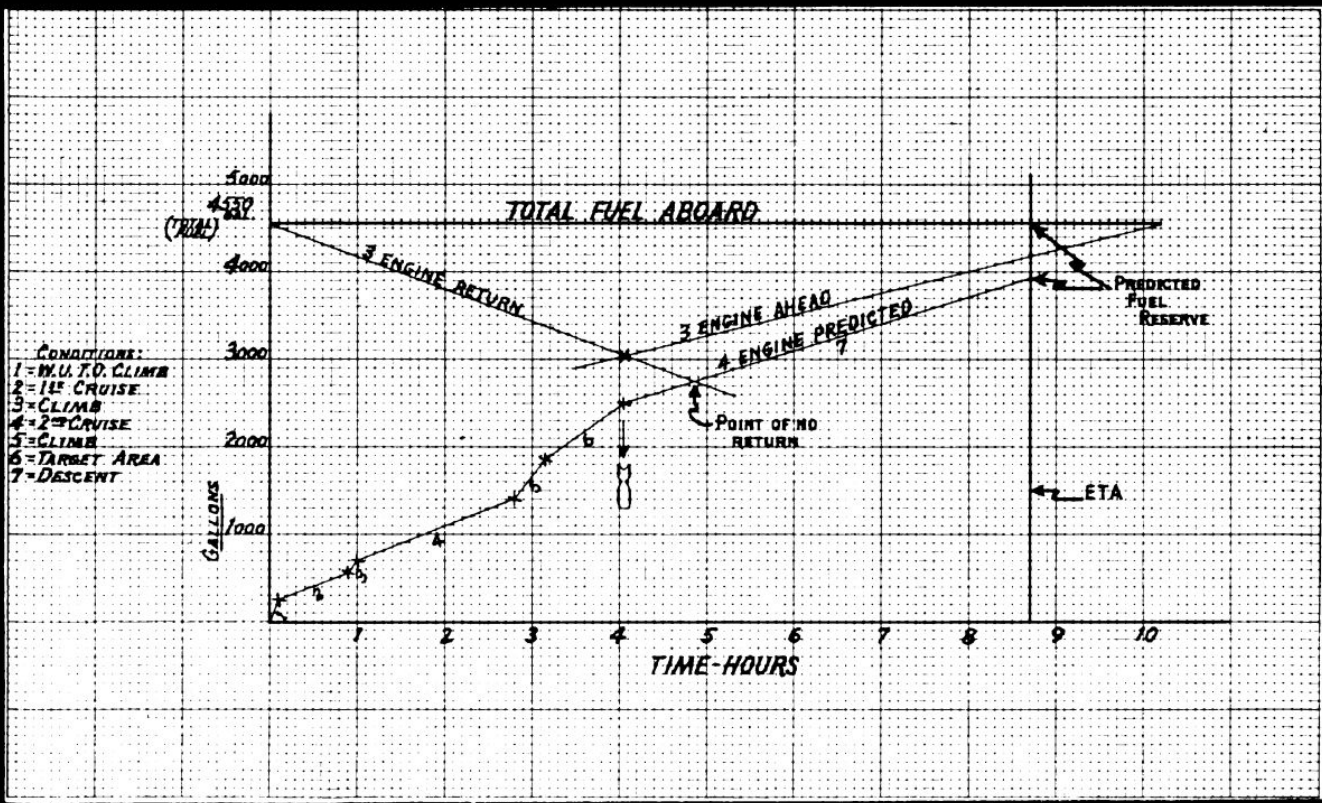

WING <u>502nd</u> GROUP <u>140th</u> AIRCRAFT NO. <u>44-10276</u>		AIRCRAFT MALFUNCTION REPORT			TYPE OF MISSION <u>COMBAT</u>	DATE <u>2 AUGUST 1945</u>	
ITEM	DESCRIPTION OF TROUBLE	WHEN DISCOVERED	SYMPTOMS	ACTION TAKEN	PROBABLE CAUSE		
1.	NO. 2 ENGINE BACKFIRES AT HIGH POWER SETTINGS.	0630	INTERMITTENT BACKFIRING AT 2400RPM, 43.5" MP. ACCOMPANIED BY PUFFS OF BLACK SMOKE FROM TURBO. RISE IN CHT, FLUCTUATION OF RPM AND MP.	ENGINE FEATHERED	LOSS OF EXHAUST VALVE OR BLOWN CYLINDER HEAD. VALVES AND MAG OUT OF TIME. CARB. OUT OF ADJUSTMENT.		
2.	PUFFS OF BLUISH SMOKE FROM TOP INBOARD SIDE OF NO. 4 NACELLE	0815	PUFFS OF BLUISH SMOKE	NONE	OIL HITTING HOT COLLECTOR RING CAUSED BY: CLAMPS ON PUSH ROD HOUSINGS LOOSE ROCKER BOX COVERS LOOSE OIL FROM PROP GOVERNOR BASE		
-INDICATE THE OPERATION OF THE FOLLOWING-							
UNIT OR SYSTEM		O.K.	N.G.	UNIT OR SYSTEM		O.K.	N.G.
BOMB BAY DOORS & BOMBSIGHT		✓		GENERATORS		✓	
CABIN HEATING & PRESSURE		✓		ELECTRICAL		✓	
CARBURETORS			✓	HYDRAULIC SYSTEM & BRAKES		✓	
COMMUNICATIONS		✓		INDUCTION (BACKFIRES)		✓	
FLIGHT CONTROLS & AFCE		✓		INSTRUMENTS		✓	
FUEL TRANSFER		✓		LANDING GEAR		✓	
				MAGNETOS & IGNITION		✓	
				PROPELLER & GOVERNORS		✓	
				RADAR		✓	
				TURBOS & CONTROLS		✓	
				VACUUM		✓	
				ARMAMENT-CFC-COMPUTERS		✓	

John Smith 1st Lt. P.F.E.

SIGNATURE OF CREW MEMBER REPORTING MALFUNCTION

I HAVE ENTERED ALL MALFUNCTION ON THE FORM 1-A

John Smith 1st Lt.

ITEM	CAUSE OF MALFUNCTION	
1.	LOSS OF EXHAUST VALVE ON NO. 16 CYLINDER. CYLINDER CHANGED.	<p>NOTE: 1. Face of this form to be filled out, in duplicate, and signed by the flight engineer and by each of the following listed crew members who has equipment malfunction: (A) Bombardier. (B) Navigator. (C) CFC Gunner (D) Radio Operator. (E) Radar Operator (F) Photographer. (G) Any other member.</p> <p>2. Complete and specific details will shorten troubleshooting. Trivial details, I.E., Air Speed, Altitude, time, and the settings, on apparatus at time of malfunction will assist maintenance crew.</p> <p>3. Flight Engineer is responsible for malfunction reporting procedure and will (A) collect both copies of all reports. (B) Transcribe necessary entries on form 1A. (C) deliver originals to the crew chief on landing (D) deliver copies to group flight engineer on interrogation. (E) Collect all originals from the crew chief when work is completed. (F) Deliver each original to the crew member concerned. (G) Deliver all originals to the group maintenance engineer when crew members have certified by signature that they understand the cause and corrective action</p> <p>4. The crew chief and each shop foreman will enter on the back of this form a detailed explanation of cause of, and corrective action taken to remove, the malfunction.</p>
2.	ROCKER BOX COVERS TIGHTENED AND PUSH ROD HOUSINGS CLAMPS TIGHTENED. NO EVIDENCE OF OIL LEAK DURING ENGINE RUN-UP.	

✓
SIGNATURE OF SHOP FOREMAN
Joe Williams T/Sgt.

✓
SIGNATURE OF CREW CHIEF
John Smith 1st Lt.

✓
SIGNATURE OF FLIGHT ENGINEER

✓
SIGNATURE OF CREW MEMBER

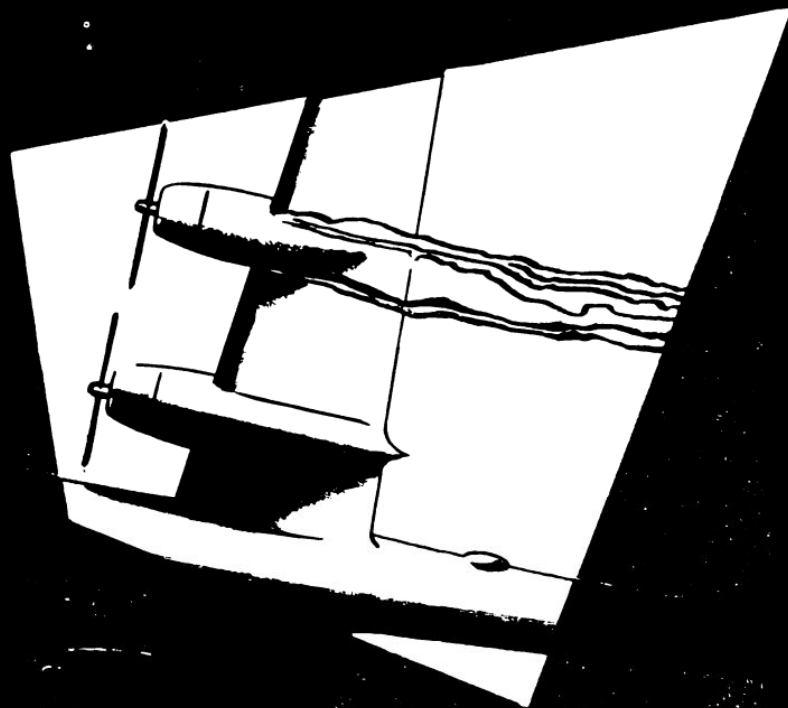

EMERGENCY PROCEDURES



When an emergency occurs—**THINK**. An analysis of B-29 accidents shows that very few accidents occur in a hurry—or as a result of a single cause. Time and time again aircraft accidents have been caused by improper emergency action when a difficulty developed. When an unforeseen emergency arises—

THINK!

ANALYZE!

PLAN!

then, ACT!

Don't allow your flight crew to operate emergency controls without your knowledge and sanction. Too many accidents are directly attributable to faulty coordination on the part of various crew members.

You are the airplane commander. Accept your responsibilities and maintain full control of your crew. Keep your crew informed and be certain your orders are clearly understood. The only way to meet emergencies successfully, whether they arise during training or operations, is by rigid adherence to one basic principle—**common sense**. And only a well-trained crew, thoroughly versed in correct emergency procedures will be able to apply common sense to the particular set of conditions facing it.

Know your airplane, know your emergency procedures—before **your** emergency arises.

EMERGENCY LANDING GEAR PROCEDURE

AIRPLANES WITHOUT MANUAL LANDING GEAR SYSTEM

Early airplanes are equipped with both a NORMAL motor and an EMERGENCY motor for the operation of the landing gear. These motors were remotely controlled from inside of the airplane and obtained their power from the NORMAL or EMERGENCY electrical systems respectively. The following is the procedure for operation of the gear with the EMERGENCY system.

1. Make sure all operating generators and the auxiliary power plant are turned on.

CAUTION: If more than one gear is defective, operate only one EMERGENCY gear switch at a time. After the gear is down and locked, do not continue operating the EMERGENCY motor as there are no limit switches in the EMERGENCY system.

2. Check the fuse in the airplane commander's aisle stand. If this fuse is burned out both the NORMAL gear switch and the landing gear transfer switch are inoperative. Replace the fuse and check landing gear transfer switch for NORMAL before trying the NORMAL gear switch again. If the fuse burns out again, return the gear switch to neutral. Replace the fuse and continue with EMERGENCY procedure as follows:

3. Move the landing gear transfer switch to EMERGENCY.

4. Pull the EMERGENCY landing gear door release handle and hold it out until the doors are fully opened.

If the doors do not open when handle is pulled, place emergency gear switch in UP position for approximately 5 seconds in order to lift gear off the door. If doors still do not open continue holding door release handle and try to force gear through doors. The EMERGENCY gear motor in some cases forces the gear to push the door open, provided the release handle is held completely out during the operation of the EMERGENCY motor. If the doors still do not open even when the gear is pushing on them, stop EMERGENCY operation so that motor does not burn out. Increase the airspeed to 260 mph in a shallow dive and

while holding the EMERGENCY cable out alternately operate the EMERGENCY gear switch up and down so as to push the doors open.

5. If EMERGENCY gear switch does not operate the EMERGENCY motors as indicated by current draw or motion of the gear it may be possible that the solenoid is not operating. This may be checked by removing the cover of the solenoid and watching the operation of the plunger while the switch is actuated. If the solenoid fails to close electrically it may be closed mechanically by pushing on the contact arm. If the defective gear does not move within 10 seconds, return the EMERGENCY gear switch to neutral or discontinue manual operation of the solenoid and proceed as described in the following steps.

6. Set the landing gear transfer switch to NORMAL and the bus selector switch to EMERGENCY. This will place the battery and auxiliary power plant on EMERGENCY circuit but will disconnect the airplane's generators and any possible failure in that circuit from the EMERGENCY circuit.

7. Again operate the EMERGENCY gear switch controlling the defective gear, but if the defective gear does not move within 10 seconds return the switch to neutral.

8. If the foregoing attempts to lower the gear have been unsuccessful and the nacelle doors are open and have operated properly electrically, it is possible to energize the gear screw with both the NORMAL gear motor and the EMERGENCY gear motor. This can be done by placing the landing gear transfer switch in the NORMAL position and the bus selector switch in the EMERGENCY position and operating at the same time both the NORMAL gear switch and EMERGENCY gear switch to the down position.

9. If the gear still does not lower, it may be because of a fault in the NORMAL gear electrical circuit. This circuit may be isolated in the following manner. Place the landing gear transfer switch in NORMAL and turn the bus

RESTRICTED

selector switch to **EMERGENCY**. Turn off all engine-driven generators. Move **EMERGENCY** gear switch on the defective gear to the **DOWN** position. If the gear operates, return the **EMERGENCY** gear switch to neutral when the gear is down and locked. Turn on all operating engine generators and watch closely for any movement of the defective gear. If the gear does not move, the airplane may be landed safely with the generators on. If the defective gear starts to retract set the propellers at 2400 rpm and service the main and emergency hydraulic systems before proceeding with the following steps. Turn off all engine generators and lower the defective gear and 25° of flaps with the **EMERGENCY** gear switch and land with the generators off. It is important to realize that in this case only the **EMERGENCY** electrical circuit is energized and electric power is not available for any other equipment

in the airplane which does not take power from the **EMERGENCY** circuit. This means no radio or interphone communication, no landing lights, and no warning horns. Also, you cannot change the TBS or rpm from the values previously set. Therefore, stop the airplane with as few brake applications as possible, cut all engines, switches, and the putt-putt while still on the runway. Do not taxi the airplane to the line. Have it towed in. Place the airplane on jacks immediately before any power is turned on.

Note: If the nose gear alone fails to extend, check the nose gear motor fuse (150 or 200 amps) in the nosewheel well, then try the **NORMAL** landing gear switch. If this fails to extend the gear, the emergency procedure described above can be followed, except that the wheel well doors operate mechanically from the gear and have no effect on the gear lowering.

AIRPLANES WITH MANUAL LANDING GEAR SYSTEM

A manual system for the extension and retraction of the landing gear is installed in recent airplanes. Driveshafts from the landing gear retraction screws are brought into the bomb bay where they may be operated by the portable emergency motor used for the wing flaps, or by a hand crank. Cable-controlled clutches disconnect the normal motors from the landing gear mechanism when the manual system is to be used. The same cable which operates the clutch also trips the nacelle doors.

Note: On later airplanes the nacelle door motors have been removed and replaced by a mechanical linkage. The pull handles, which formerly released the nacelle doors and disengaged the normal landing gear motor, now perform only the latter operation.

Main Gear

Each main landing gear is operated manually from a gear box installed just aft of the rear wing spar and above each catwalk in the rear bomb bay. The gear box on the right hand side operates the right gear; the box on the left, the left gear.

Use the following procedure to operate each main gear with this emergency system:

1. Place landing gear switch in **OFF** position. Pull the nacelle door release and clutch engagement handle. Allow the swaged ball on the cable to drop into the slot on the handle bracket which retains the cable in the extended position. This puts a spring tension on the clutch lever, which subsequently moves to mesh the clutch when the jaws are aligned. The engagement of the clutch on the manual side is simultaneous with the release of the clutch on the motor side.

2. To raise the gear, insert the portable motor into the lower gear box socket and lock it in position. The switch on the motor controls the direction in which the gear travels. A decal on the motor and also on the airplane gives the correct switch position for both right and left hand gears. Take extreme care to stop the motor as soon as the gear reaches either limit of travel. This is necessary because there are no limit switches in the circuit and damage to the motor or the clutch results if it is allowed to operate more than a second or two when the gear is not moving.

3. Always return the clutch handle to the **IN** position immediately after emergency extension or retraction is complete. This causes an

internal spring in the clutch mechanism to release the emergency manual system and engage the normal electric motor. Since the retraction motor is series wound, it develops excessive speed and destroys itself if run with the load removed. Therefore, it should always remain engaged except when the emergency system is actually being used.

4. In case all electrical power has failed, the main gear may be operated by the hand crank. It is necessary to pull the clutch-shifting cable noted above in order to connect the hand-crank drive to the landing gear (as was done when the portable motor was used). Use the upper position for retracting the gear and the lower position for extending the gear. It requires 774 turns to raise the gear, which takes about 30 minutes, and 378 turns to lower the gear, which takes about 12 minutes.

WARNING

Always use the switch on the motor. While the switch on the pilot's aisle stand controls the portable emergency landing gear motor, it should not be so used as there is no good indication when the gear is fully extended or fully retracted. Also, the airplane commander is unable to tell when the portable motor clutch is slipping. Since it is necessary to release the nacelle doors and shift the clutch by means of a cable control in the bomb bay, the switch on the motor should be used by the operator in the bomb bay.

Nose Gear

The nose gear can be operated manually from a gear box installed at the top of the nose screw. To operate the nose gear with this emergency system:

1. Remove the beam from the clamp on the copilot's armor plate stanchion and rotate to a horizontal position.
2. Secure the beam with eye bolt and wing nut to the bracket on the airplane commander's armor plate stanchion.
3. Remove the hand crank from under the entrance hatch and insert into the square hole in the beam.
4. Unscrew the pressure sealing plug in the

floor, using the hand crank as a wrench.

5. Insert the crank in the gear box.

6. If the crank does not turn, open the entrance hatch and disengage the motor with the clutch lever. Moving the lever toward the right (facing forward) disengages the motor. A spring that attaches to either of two clips is provided on the handle to retain it in the engaged or released position. Normally, the motor is left engaged and is allowed to rotate as the gear is actuated. The number of turns of the crank required to raise or lower the gear is 257, and gear ratio is 3 to 1. Extension and retraction are each accomplished in 2 to 3 minutes.

7. **Always return the clutch handle to the engaged position after hand cranking if the clutch has been released.** Also remove the crank and stow the beam. **Note:** Instruction decals are installed in the airplane to explain the operation of the manual retraction system. A decal is provided above each gear box at the cranking stations for the main gears. A decal is also provided on the back of the airplane commander's armor plate for instructions regarding the nose gear. In airplanes with the manual emergency landing gear system, just described, the emergency electrical system has been deleted. Therefore, these airplanes do not have a power transfer switch or a bus selector switch.



EMERGENCY FLAP OPERATION

A portable emergency motor in the bomb bay permits the emergency lowering of the wing flaps and, depending on the airplane series, can be used for emergency operation of the bomb bay doors or the landing gear. It is normally stowed in position to operate the flap and must be moved to another position to operate the bomb bay doors or landing gear.

If the normal flap system fails and it is impossible to operate the flaps by operating the normal flap switch, use the following emergency procedures.

To Lower Flaps



1. Place the flap switch in neutral and check fuse.
2. The landing gear transfer switch and the bus selector switch should be in NORMAL.



3. Have a crew member put the switch on top of emergency motor down. The motor is normally stowed in the flap socket in the center wing section and plugged into emergency bus.

4. Lower the flaps by placing landing gear transfer switch in the EMERGENCY position. If the bus selector switch is used the putt-putt must be ON THE LINE and the tail gunner operating the bus selector switch must return the switch to NORMAL as soon as informed by the copilot that the flaps are down as desired. To be safe in case of the necessity of a go-around, don't lower the flaps more than 30°.

5. As a last resort, put the normal flap switch down with the landing gear transfer switch on NORMAL. Then put the bus selector switch on EMERGENCY. The switch on top of the emergency motor must be in the same corresponding position as the normal flap switch, or the normal and emergency motors will work against each other.

Use the reverse procedure to raise the flaps.

Recent airplanes incorporate a control for the emergency wing flap motor in the pilots' aisle stand. This switch is connected in parallel with, and operates similarly to, the switch on the motor noted in the preceding paragraph. Care should be taken when using this switch that it is placed in the OFF position when the flap indicators show the flaps to be at either limit of their travel. This precaution must be observed, as there are no limit switches in the circuit. Check your airplane to determine whether it is necessary to use the power transfer switch before the emergency flap switch becomes operative.

WARNING

Do not run the motor beyond the upper and lower flap limits. This burns out the motor, as it has no limit switch. For emergency flap operation, don't depend on the hand crank stowed forward of the rear entrance door. This crank is for starting the engines and does not fit the flap socket.

EMERGENCY BOMB BAY DOOR OPERATION AND BOMB SALVO CONTROL

There are two types each of bomb door actuator and bomb release systems installed on various series of airplanes. The first airplanes incorporated doors actuated by electric motor-driven screws. More recent airplanes include a pneumatic bomb door control system using compressed air pistons to position the doors. Early airplanes incorporated a mechanical bomb release system for emergency salvo that was actuated by cables from the airplane commander's and bombardier's positions. More recent airplanes use a completely electrical bomb release system including emergency salvo control. The emergency operation of each of these systems is covered in this section under the applicable subheading.

Emergency Operation Of Electric Motor Operated Bomb Doors

1. Install the portable emergency motor, normally stowed in position to operate the flaps, in the forward or aft bomb bay door socket in the center of the right hand catwalk. Plug the cable into the outlet just above the socket. The motor switch should be in NEUTRAL.

2. Power must be on the emergency system if the airplane is so equipped.

3. The portable emergency motor is controlled by means of solenoid switches in the solenoid shield on the right side of the aft bomb bay just aft of the rear spar. Control of the solenoid switches will be different depending on the age of the airplane involved. Originally the only control switch was mounted on the portable motor itself, adjacent to the hand grip. Later some airplanes were modified by removing the control switch from the motor and installing it on the equipment panel at the left side gunner's station. Motor rotation and, consequently, direction of throw for the switch lever, is opposite for front and rear bomb bays. Care must be taken to operate the switch as directed by the decal at the switch.

WARNING: The bombardier's bomb door control handle and the switch on the emergency

bomb door motor must be in the same position; that is, either both open or both closed, to prevent operation of one motor against the other. Even though the normal bomb door motor is apparently inoperative, make sure that the normal bomb door control is in the same position as the control switch on the emergency motor to prevent burning out the emergency unit.

This motor has no limit switch. Operation for more than 2 or 3 seconds beyond the full open or full closed position may burn out the motor. The engine hand crank cannot be used to operate the bomb bay doors.

Emergency Operation Of Pneumatic Bomb Bay Doors

Emergency opening of the pneumatic bomb doors is provided in the event of failure of electrical control or air supply and is accomplished by two release handles and two closing handles (all airplanes are not equipped with closing handles). Opening is accomplished by pulling either the release handle located at the rear of the pilots' aisle stand or the one located aft of bulkhead 218. Pulling either of these handles releases the forward doors. When the forward doors are approximately 70° open, a cable connected to the left forward door opens the rear doors.

Originally, opening the forward doors by any means resulted in operation of the emergency release of the aft doors. On later airplanes the system permits normal operation of either forward or aft doors, with the other bay remaining closed, and it is necessary to hold the emergency operating handle at the aisle stand in the release position until the aft doors are open.

Normally, emergency door release on this later system results in operation of both doors. However, if the aft doors do not open with the first pull, a second pull accomplishes release. If air pressure is available the doors may be closed by pulling the closing handles located on the right side of the forward bomb bay crosswalk and at the forward end of the right hand

RESTRICTED

catwalk in the rear bomb bay. Both handles must be pulled and the forward bomb bay must be closed first.

Originally, no provisions were made for emergency closing if air pressure is not available, but most airplanes have been modified in the field to permit emergency closing by means of cables which may be attached to the bomb hoists. Later airplanes will be equipped with an emergency cable retraction system for each bay with controls for the forward bay in the floor aft of the bottom turret, and controls for the aft bay in the floor forward of the senior gunner's seat pedestal.

To operate this system, the hinged access door is opened which simultaneously actuates the 4-way valve to the doors-closed position and engages a ratchet wheel with a cable drum for cable retraction of the doors. An extension handle, stowed on the navigator's table leg in the forward compartment and on the gunner's seat pedestal in the aft compartment, is inserted in the ratchet wheel socket for turning the cable drum.

Emergency Bomb Release On Airplanes With Electric Motor Operated Bomb Doors and Mechanical Bomb Control System

Pull the release cable by winding bombardier's hand wheel $2\frac{1}{2}$ turns clockwise or by pulling one of the emergency release handles. The handles are located at the aft end of the pilots' control stand and on the forward wall of the rear pressurized compartment near the left hand cabin pressure regulator. The first part of the pull releases the doors, allowing them to open. The second part of the pull operates the bomb release levers, releasing the bombs unarmed. Total length of pull is about 30 inches.

After such emergency release, rewind the system by turning wheel counterclockwise $2\frac{1}{2}$ turns. The doors may then be closed after placing the bomb door handle in the OPEN position until the retraction mechanism extends and connects to the doors. When the retraction screws have hooked on to the doors, move the bomb door handle to CLOSE and close the doors.

Emergency Bomb Release On Airplanes With Electric Motor Operated Bomb Doors and All-electric Bomb Control System

1. Salvo bombs unarmed by closing any one or all of the salvo switches located on the pilots' aisle stand, bombardier's switch panel, and the crew salvo switch immediately forward of the right side gunner's station. With operation of the salvo switch, the bomb door motors automatically start to open the doors and the bombs are salvoed when the doors are open far enough to close the salvo safety switches.

WARNING: The salvo switch must be held closed until the bombs are salvoed. This will require approximately 30 seconds. The doors may then be closed by the normal bomb door switches located on the pilots' aisle stand and on the bombardier's switch panel.

2. If you need more rapid salvo, pull the emergency door release handle at the aft end of the airplane commander's control stand (or in the rear pressurized compartment adjacent to the left hand cabin pressure regulator) and hold the salvo switch on. The bomb door motors operate, but if the bomb doors are equipped with snap opening provisions, the doors open rapidly and bombs are salvoed long before the electric motor operated screws catch up with the open doors. After the door actuator screws have fully extended and latched with doors, close doors by normal door switches.

Emergency Bomb Release On Airplanes With Pneumatic Bomb Door Actuators and All-electric Bomb Control System

With normal electrical power, salvo release of bombs unarmed is accomplished by closing any one or all of the salvo switches located on the pilots' aisle stand, on the bombardier's switch panel, and crew salvo switch immediately forward of the right side gunner's station. With any one of the salvo switches closed, both bomb bays are opened automatically and all bombs are salvoed unarmed when doors open enough to close salvo safety switches.

If electrical control of the doors is impossible, opening of the bomb doors is accomplished by actuating the emergency bomb door

release cable situated on the aft end of the pilots' aisle stand. Bombs may then be salvoed by means of any salvo switch or, if electric power is not available, may be dropped singly by manually tripping the release lever on each bomb shackle.

Caution

BEFORE ENTERING BOMB BAY

ALWAYS TURN SAFETY SHUT-OFF

VALVES TO OFF POSITION

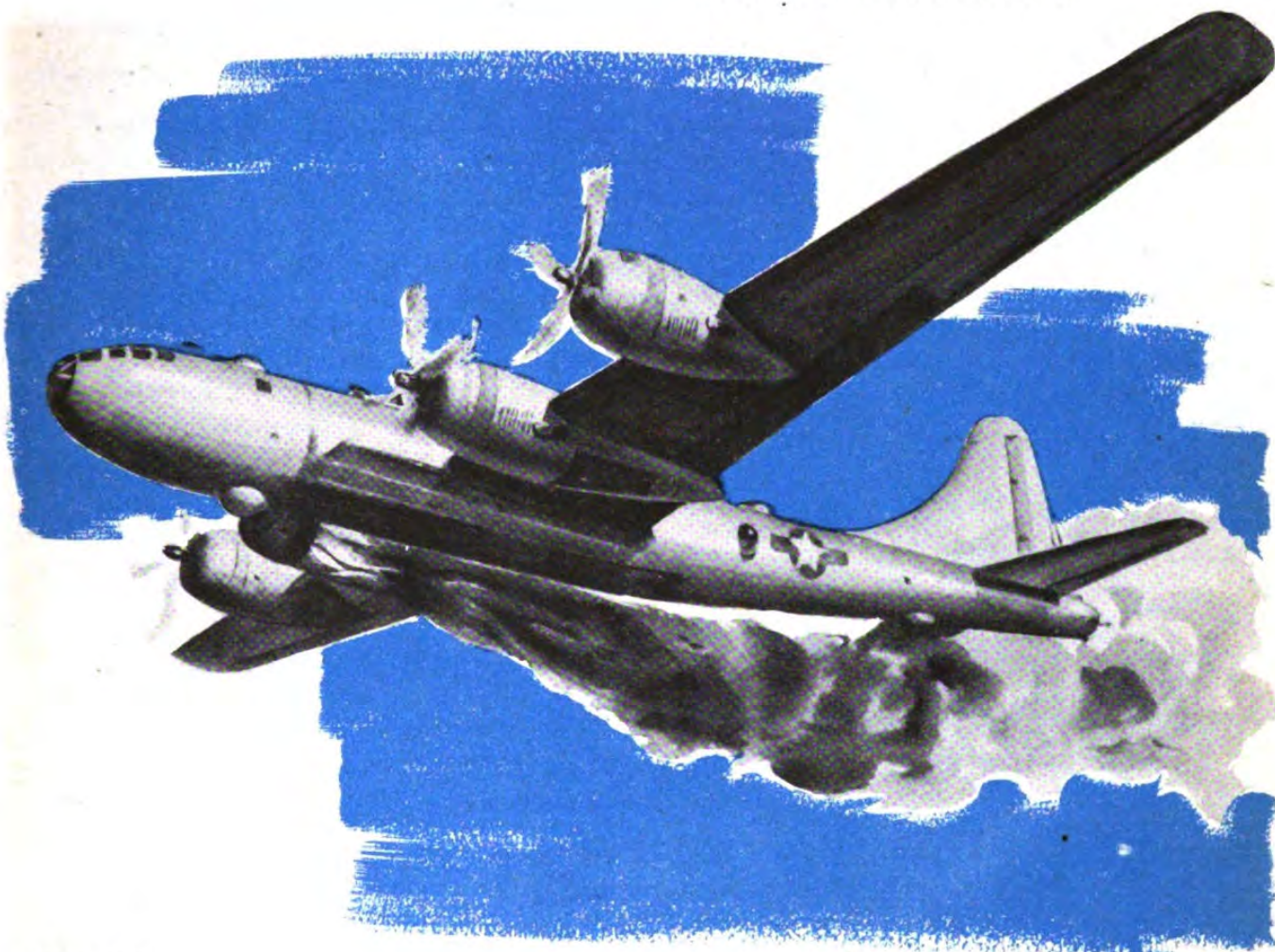

FIRE

For fighting engine or nacelle fires, the B-29 has a CO₂ system fed by two high-pressure CO₂ bottles. Lines run to all four engine nacelles and they feed CO₂ around the accessory section and into the engine induction system. A fire detection system indicates an induction system fire by means of indicator lights at the airplane commander's and flight engineer's stations. The flight engineer can direct the CO₂ charge to the desired engine by turning the selector knob

on his instrument panel, and pulling the CO₂ release handle.

Besides the nacelle extinguisher system, each airplane has three hand extinguishers for cabin fires. One CO₂ extinguisher is on the in-board side of the flight engineer's control stand, another is in the aft pressurized compartment, aft of the auxiliary equipment panel. The third CO₂ extinguisher is near the rear entrance door.

RESTRICTED

123

NACELLE FIRE IN FLIGHT

Crew member spotting the fire uses CALL position on jackbox and reports: "Fire in No. "

The following procedure should be followed immediately. It applies to all nacelle or engine fires in flight regardless of location or cause.

AIRPLANE COMMANDER

1. Throttle back.
2. Feather propeller.
3. Order engineer to use engine fire procedure.

COPILOT

1. Stand by to lower landing gear and operate bomb salvo switch to open doors and clear bomb bays if fire appears to be uncontrollable.

ENGINEER

3. Mixture control in FUEL CUT-OFF.
Close fuel shut-off valve.
Stop booster pump.
Set cowl flaps not to exceed 10°. Select correct engine with fire extinguisher selector valve and pull one handle.
Pull second fire extinguisher handle at command of airplane commander.
Open oil cooler and intercooler.
Turn off generator and proper engine ignition switch.

4. Alert crew for bailout.
5. Order second fire extinguisher if necessary.
6. If fire is out of control after all procedures have been accomplished, bail out crew.

Note: If fire persists, and propeller has feathered, the airplane commander lowers the nose slightly to increase air-speed to 250 mph in an attempt to blow out the fire. At the same time the engineer pulls the second fire extinguisher handle (at command of airplane commander).

DIAGNOSING SMOKE AND FIRE

Eighty per cent of all power plant fires go out when the propeller is feathered. Conversely, if the nature of the fire makes feathering impossible, the fire is probably uncontrollable. An uncontrolled fire usually starts in the power zone, bypasses the fire seal and burns a fuel or oil line, dumping huge quantities of combustible fluid into the accessory section. Fires of this sort are usually accompanied by bright orange flames which may burn over the wing with an accompanying turbulence. This adds considerable drag and may destroy the lift. The nacelle structure burns off in about two minutes with an uncontrollable fire in the accessory section.

Note: In most airplanes the CO₂ system will only extinguish a fire between the fire seal and fire wall. Because few fires originate there, this CO₂ system is ineffective in handling most fires. Later airplanes are equipped with induction system fire detectors and a revised CO₂ system which empties 90% of its charge into the blower case. Future airplanes will have a bank of 12 detectors at the engineer's station, oil shut-off valves, and a larger capacity fire extinguishing system. Be sure you know what kind of equipment your airplane has.

Accurate and rapid diagnosis of engine abnormalities in flight generally presents a difficult problem. However, if correct and clear information from the rear of the airplane is coupled with indications from the engine instruments and observation of the engines from the front, fairly effective action may be taken with a minimum expenditure of time. In case of an obvious fire it is imperative that the engine be shut down immediately and corrective measures taken to insure safety of airplane and crew.

Torching should not be confused with engine fires. Torching takes place when excessively rich mixtures result in visible flame at the exhaust stack, whereas flame from an engine fire may come from cowl flaps, access panels, or may even burn through the engine nacelle.

Smoke symptoms, with their causes and probable remedies, are illustrated herewith. The importance of accurate observation and clear, concise reporting of these symptoms to the cockpit cannot be over-emphasized.

SYMPTOM	PROBABLE CAUSE	CORRECTIVE ACTION
Thin Black Smoke from Exhaust	1. Rich mixture at high power.	1. None.
	2. Rich mixture at high rpm and low manifold pressure.	2. Adjust power setting.
	3. Leaky primer.	3. None.

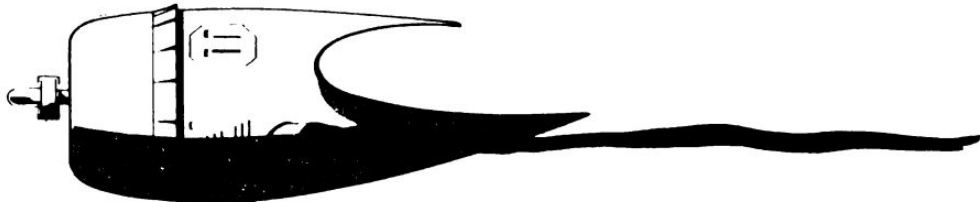

SYMPTOM	PROBABLE CAUSE	CORRECTIVE ACTION
---------	----------------	-------------------



Puffs of Black Smoke from Exhaust

- | | |
|--------------------------|--|
| 1. Detonation. | 1. Check fuel pressure. Check mixture control setting. Richen mixture. Reduce manifold pressure. Reduce cylinder-head temperature. |
| 2. Cylinder malfunction. | 2. Reduce power. Watch for fire. |
| 3. Fouled sparkplugs. | 3. Increase cylinder-head temperature to limit. |

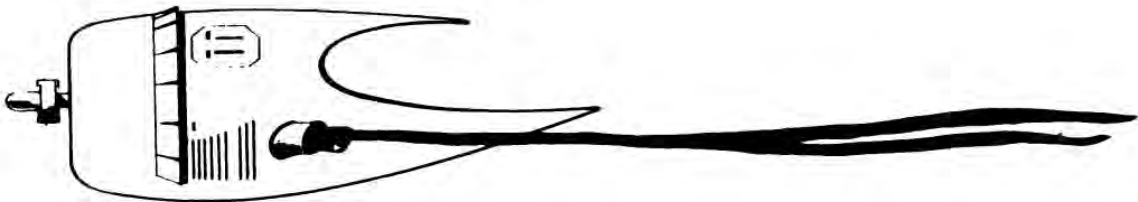

Thin Bluish White Smoke from Exhaust

- | | |
|----------------------------|--|
| 1. Internal failure—rings. | 1. Check oil pressure. Check oil quantity. |
|----------------------------|--|

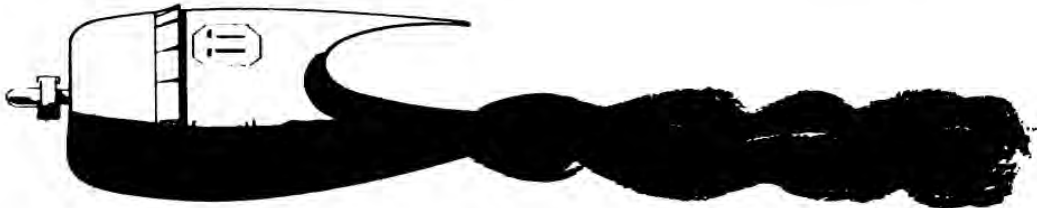

Dense Black Smoke from Exhaust

- | | |
|------------------------------------|---|
| 1. Induction fire (initial stage). | 1. Cut off fuel. Feather propeller. Watch for fire. |
|------------------------------------|---|

SYMPTOM

PROBABLE CAUSE

CORRECTIVE ACTION

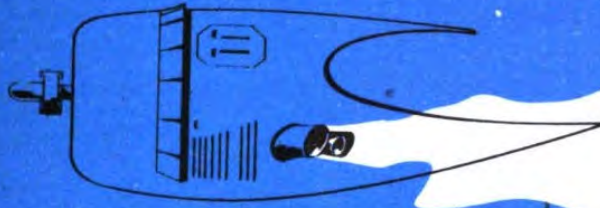

Dense White Smoke from Exhaust

1. Induction fire (advanced stage).

1. Cut off fuel. Feather propeller. Watch for fire.

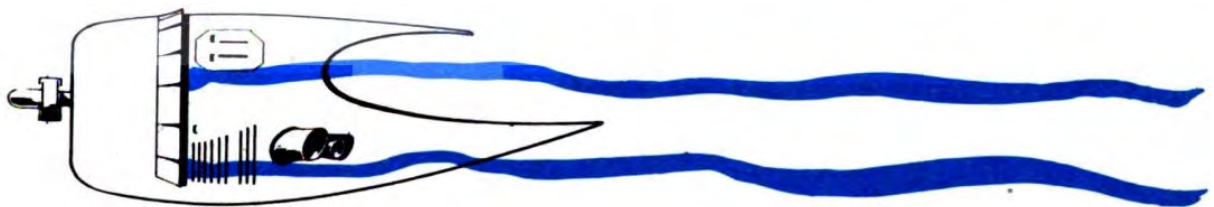

Thin Bluish White Smoke from Cowl Flaps

1. Oil leak.

1. Check oil pressure. Check oil quantity.



Puffs of Bluish White Smoke from Cowl Flaps

1. Oil leak.

1. Check oil pressure. Check oil quantity. Watch for internal failure of engine.

SYMPTOM

PROBABLE CAUSE

CORRECTIVE ACTION

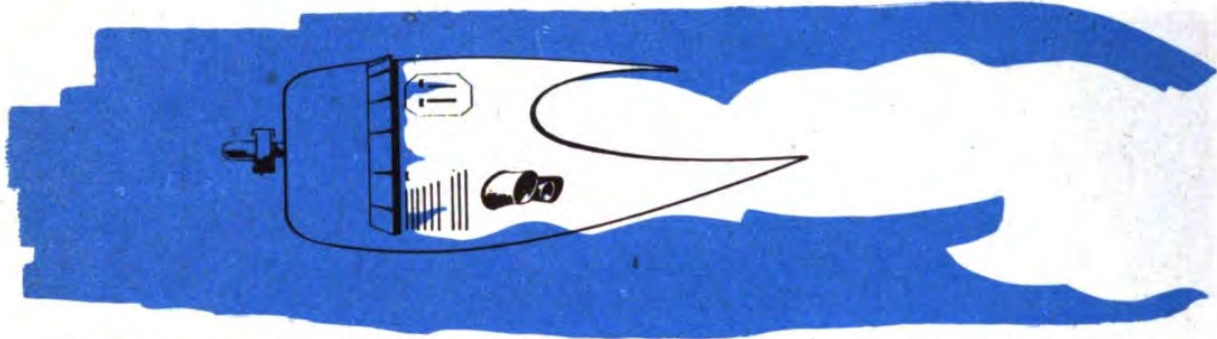

Dense White Smoke from Cowl Flaps

1. Nose section casting afire.

1. Cut off fuel. Feather propeller. Use fire procedure.

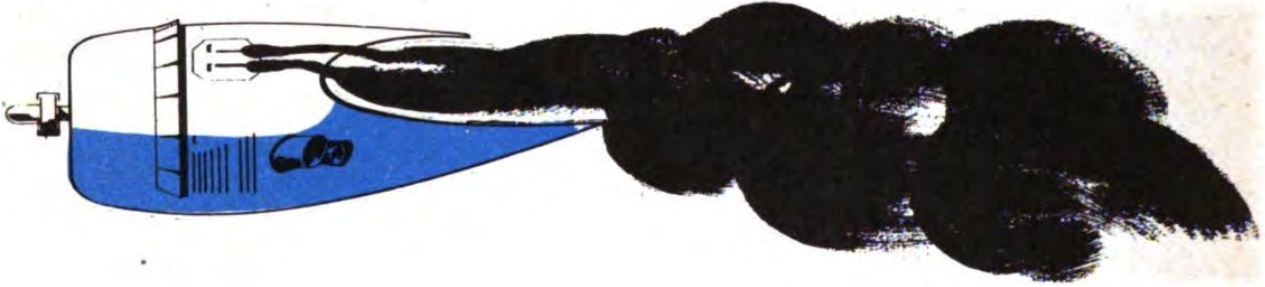

Dense Black Smoke from Access Panels

1. Accessory section afire.

1. Cut off fuel. Feather propeller. Use fire procedure.



Thin Bluish Grey Smoke from Access Panels

1. Oil leak in accessory section.

1. Check oil pressure. Check oil quantity.

SYMPTOM	PROBABLE CAUSE	CORRECTIVE ACTION
---------	----------------	-------------------

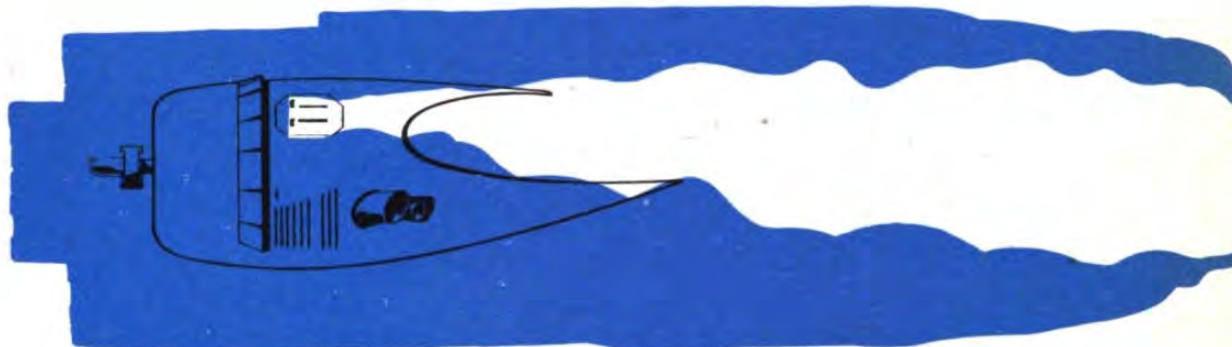

Dense White Smoke from Access Panels

1. Advanced induction fire.

1. Shut off fuel. Feather propeller. Use fire procedure.

Nacelle or Engine Fire on the Ground

If you know the fire to be a torching turbo, put it out by increasing throttle setting momentarily. For other engine or nacelle fires on the ground, use the following procedure:

1. Instruct the flight engineer to stop all engines, close all fuel shut-off valves and fully open the cowl flaps in order to allow greatest possible access.
2. Instruct the flight engineer to release the nacelle fire extinguisher in the proper nacelle.
3. Request tower (by radio if possible) for additional ground fire-fighting equipment.
4. Have all electric power turned off.

Cabin Fires During Flight

In all cabin fires during flight, whether the origin is electrical or otherwise, immediately warn the crew, and pull the emergency pressure relief handle if the cabin is pressurized.

If heavy smoke and fumes are present, go on pure oxygen. Use closest portable extinguisher on fire. Lower nose gear so that nose gear well will be available as bailout exit if necessary.

If the cabin fire is believed to be caused by an electrical short circuit, turn battery switch, putt-putt and all generators off immediately before using extinguisher on fire. Safety of the B-29 depends on adequate electrical power being available at all times, therefore prompt action is necessary to assure preservation of this system. If the cabin becomes excessively smoky or gaseous after using the fire extinguisher and the flame is out, open the cockpit windows. This is the best way of getting ventilation into the forward compartment. Opening the bomb bay doors and the pressure bulkhead door into the bomb bay will also aid ventilation.

If the fire is extremely bad, and there is danger of an explosion from fuel tanks, sound the alarm bell so the crew can prepare to abandon the airplane. Under no conditions should any crew member abandon the airplane before the order is given by the airplane commander.

RESTRICTED

129

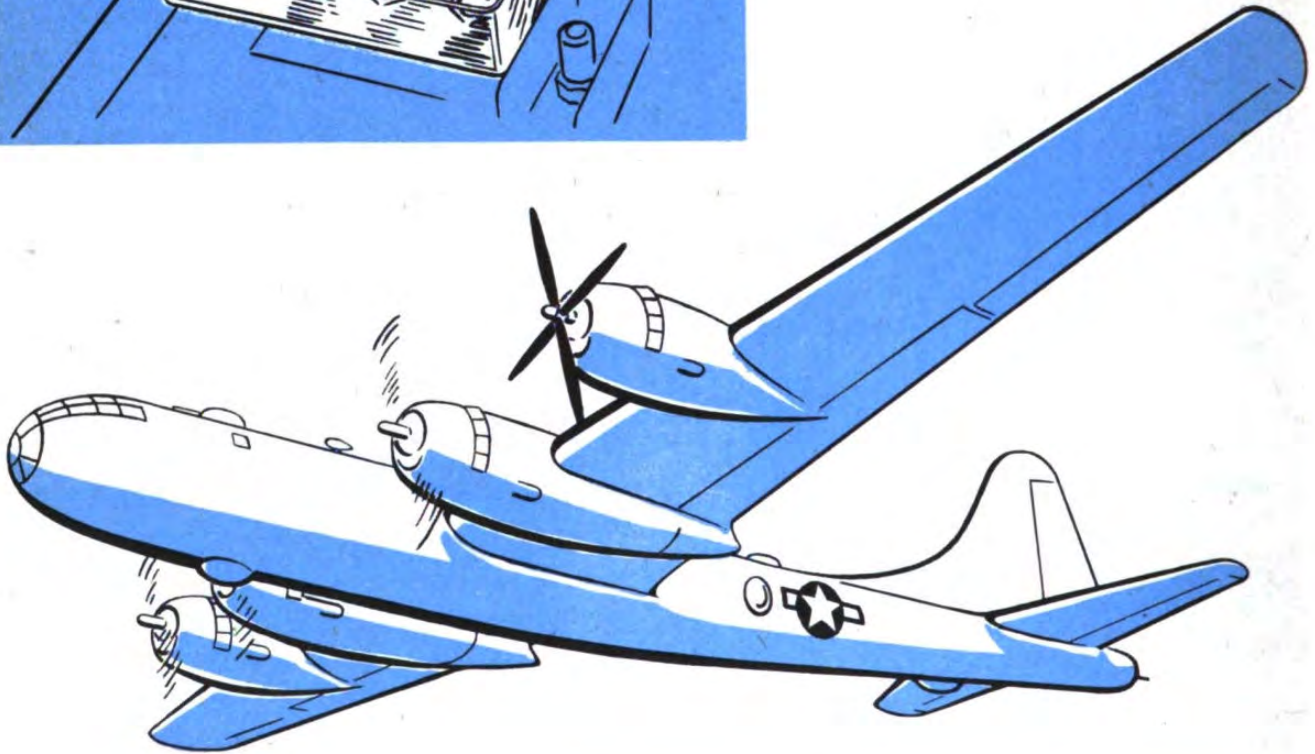
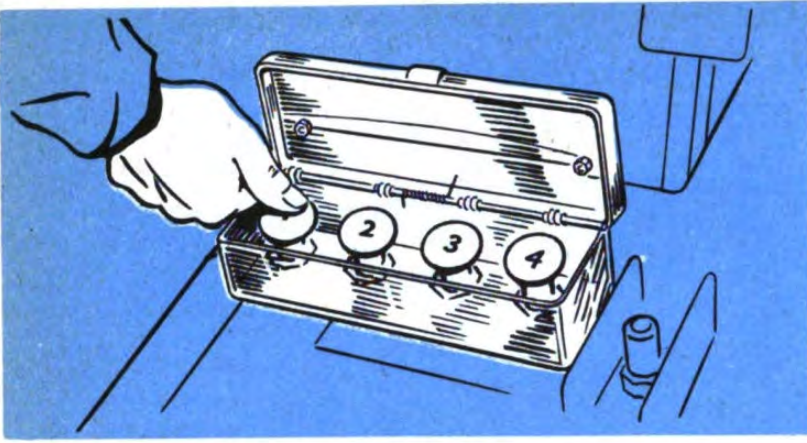

PROPELLER FEATHERING

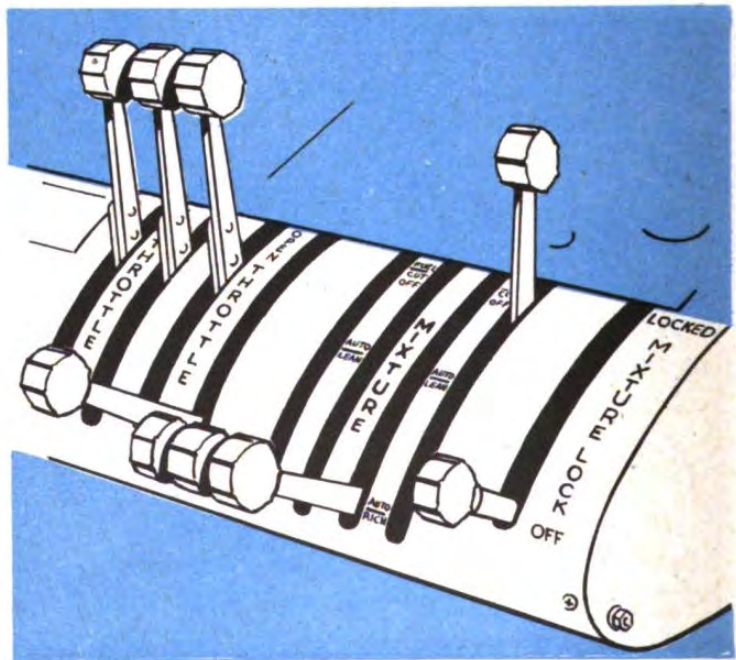

Feathering In Flight

1. Airplane commander closes throttle on malfunctioning engine.

2. Airplane commander notifies the flight engineer to shut off the malfunctioning engine and at the same time depresses the proper feathering button. The flight engineer performs the following steps as the propeller begins to feather:

- a. Move **proper** mixture control to FUEL CUT-OFF position.
- b. Turn off proper fuel shut-off valve.
- c. Turn off the fuel booster pump.
- d. Set fire extinguisher selector to proper engine. **Before cowl flaps, intercooler door, and oil cooler door are closed make a close visual inspection of the engine and nacelle to ascertain that no fire exists.**
- e. Close cowl flaps.
- f. Close intercooler door.
- g. Close oil cooler door and leave switch in OFF position.
- h. Turn off generator switches.
- i. If inboard engine, check position of vacuum selector handle. If the selector is set to the feathered engine, move handle slowly to other inboard engine.
- j. If inboard engine, close the cabin airflow valve.
- k. When propeller stops turning, **shut off proper ignition switch.**

Unfeathering In Flight

1. Airplane commander checks propeller rpm setting, which should be full low position.

2. Airplane commander depresses feathering button until engine rpm increases to approximately 600 rpm. He then notifies the flight engineer to start the engine.

3. The flight engineer starts the engine using

the following procedure:

- a. Place fire extinguisher to engine to be started.
- b. Put oil cooler switch in AUTOMATIC position.
- c. Open fuel shut-off valve.
- d. Turn fuel boost pumps on LOW.
- e. Turn ignition switch ON.
- f. Open throttles to approximately 1 inch.
- g. To obtain full rich mixture, move the mixture control to AUTOMATIC RICH.
- h. Warm up engines at approximately 1200 rpm until oil temperature is 55°C.
- i. Gradually increase power until desired setting is reached.
4. As soon as engine is running smoothly during warm-up, increase turbo boost as desired.

When

When the feathering button is depressed, watch the tachometer closely. If rpm does not increase in the first 2 or 3 seconds, pull out the feathering button. Reduction of rpm, airspeed, and altitude, and an increase in oil temperature may aid feathering. Push the feathering button in again and wait approximately 5 seconds. Observe rpm. If the propeller is feathering, allow it to continue. However, if at any time rpm begins increasing instead of decreasing, pull the feathering button out immediately. Normally, under the above conditions, the feathering button will pop out of its own accord. The feathering button should be punched successively, **not held down**, until the feathering process is completed.

See **Curtis Electric Propeller System** for feathering and unfeathering procedure with that installation.

DITCHING PROCEDURE

General

Ditching calls for more coordinated effort on the part of the crew than does any other procedure. Everyone who is associated with the mission of the crew must cooperate to see that the crew has everything available to cope with the situation. Inspection must be accomplished of every life raft, CO₂ cartridge, accessory equipment, safety wiring, sustenance kits, medical kits, and life jackets. Everything must be in readiness to enable the crew to evacuate the airplane and wait for rescue.

Ditching Drill

Drill is the nearest approach to the reality of ditching itself. The crew must learn to move quickly and to make every movement count.

A well-trained crew will understand the problems and know how to handle them when they occur. Talk these contingencies over with the rest of the crew and practice each again and again. Use the emergency equipment when practicing. The success of survival depends critically upon the communication equipment, water supply, medical supplies, and the food that accompanies the crew. The airplane commander must be able to make up his mind quickly as to whether to ditch or bail out and change his decision immediately if some unforeseen development arises.

Preparation

Ditching equipment should be in readiness at all times when flying over water. As soon as the necessity of ditching is evident and the airplane commander has given the order to prepare for ditching, jettison all equipment that is unessential.

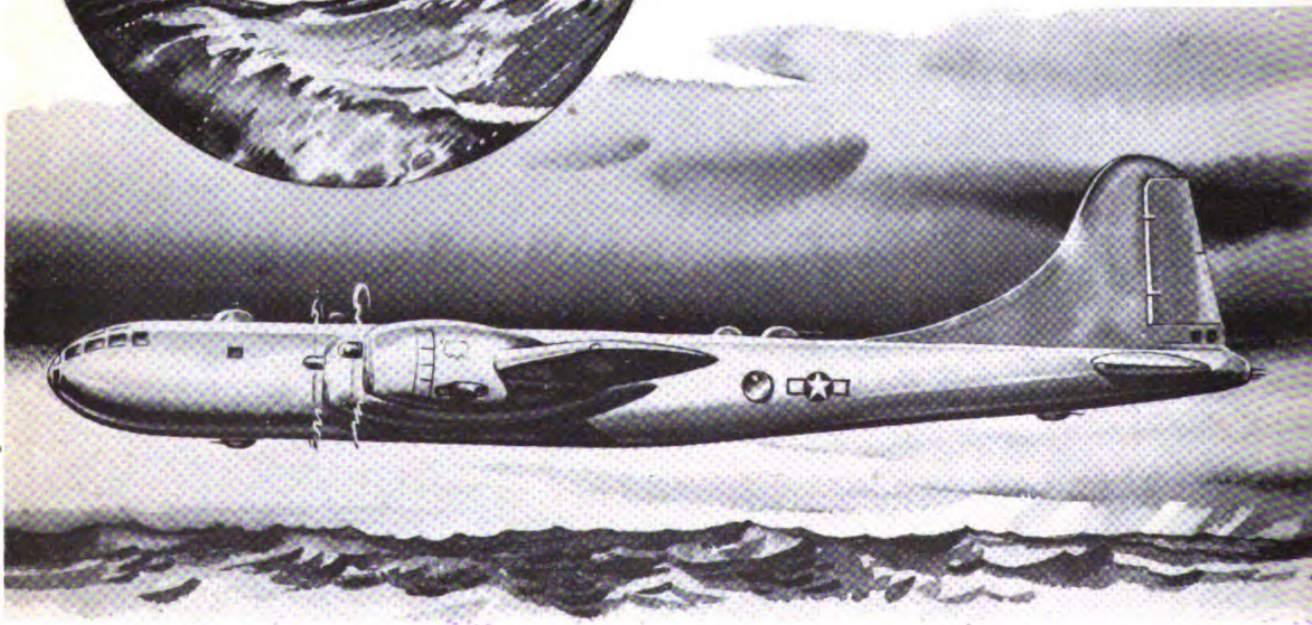

Crew Procedure

The procedure described herewith is to be followed during all ditchings. This procedure was disseminated by Hq. AAF, AC/AS-3, Requirements Division, as of December 1945, with a notation that Air Force commanders are authorized to make procedure revisions necessitated by special aircraft equipment installation, but that other changes in procedures must be submitted for coordination and approval, complete with diagrams illustrating the positions affected.

The crew positions described herein have been worked out to place most of the crew members in the forward pressurized compartment. They take into account the order in which those crew members come forward and the last-minute duties they must perform. However, only ditching drills by an assembled crew will determine how individual crew member's stature or build may affect these positions. Furthermore, in combat, injuries may cause some crew positions to be interchanged. A man with an injured leg could not hold himself in some of the positions described here and might have to change positions with another

member of the crew. The important things to remember are:

- a. Fill crew positions according to the stature and build, and injuries of your crew.
- b. Practice taking these positions quickly, not necessarily in the order outlined.
- c. See that your back and head are supported so you will not bounce around when the airplane hits.
- d. Remove parachute harness, winter flying boots, and flak suit, loosen shirt collar; keep flak helmet on only if you can rest it against something.
- e. Use cushions and parachutes for padding. Pull out canopy if desired, but leave shroud lines in pack.
- f. Jettison all unnecessary items which may tear loose and crash forward like projectiles when the airplane hits. This includes the bomb-sight, which usually tears itself from the stabilizer and crashes through the front glass, and the camera in the rear unpressurized compartment.
- g. In case of fire, crew members will not inflate life vest until after swimming clear of fire.
- h. Jettison all flak suits before ditching.
- i. All crew members carry out C-2 type rafts.

B-29'S WITH FOUR-GUN TURRETS

1. Airplane Commander

- a. Give warning: "**Prepare for ditching in minutes.**" Give six short rings on alarm bell. Turn IFF emergency switch ON.
- b. Open and secure window; jettison if possible.
- c. Remove flak suit, flak helmet, parachute. Remove one-man raft from parachute harness but leave in seat. Wear helmet, emergency kit, Mae West, and gloves. Fasten safety belt and shoulder harness.
- d. Radio other aircraft of your distress and then turn to interphone.
- e. Give order: "**Open emergency exits and stow loose equipment.**"
- f. Lower seat and push rearward.

g. Give order: "**Stations for ditching; impact in seconds.**"

h. Give order: "**Prepare for impact**" just before contact is expected, and send one long ring on alarm bell.

i. **Keep knees flexed at impact.**

j. Check to see that crew is clear; throw one-man life raft from window, escape through left window and inflate Mae West.

2. Copilot

a. Relay airplane commander's instructions over interphone. Receive acknowledgements from crew. Inform airplane commander: "**Crew notified.**"

b. Open window and secure or jettison it.

RESTRICTED

c. Remove flak suit, flak helmet, and parachute. Remove one-man raft from parachute harness but leave it in seat. Wear helmet, emergency kit, Mae West, and flying gloves. Fasten safety belt and shoulder harness.

d. Stand by on interphone to relay airplane commander's orders.

e. At an altitude of 300 to 500 feet order radio operator to take his ditching station.

f. **Keep knees flexed at impact.**

g. Take first-aid kit stored above engineer's seat, throw out one-man raft and exit through right window. Inflate Mae West and proceed to right wing.

3. Flight Engineer

a. Acknowledge ditching order.

b. Remove flak suit and parachute but leave in seat for padding. Remove one-man raft from parachute harness but leave it in seat. Wear flak helmet, emergency kit, Mae West, and gloves. Fasten safety belt.

c. Open emergency hatch and pass it to navigator to stow in bomb bay.

d. Remove first-aid kit from engineer's stand; place it on arm.

e. Remain in seat with head and shoulders braced against the copilot's armor plate.

f. Throw one-man raft through escape hatch and then exit.

g. Inflate Mae West and proceed to right wing.

4. Bombardier

a. Acknowledge ditching order.

b. Remove flak suit and parachute. Use parachute for padding. Remove one-man raft from harness; use it as padding at ditching position. Wear flak helmet, emergency kit, Mae West.

c. Pass bombsight back to navigator for stowing in the bomb bay. Assist in stowing all loose equipment in bomb bay.

d. Remove nosewheel lowering lever and stow; place parachute seat cushion against armor plate. Assume position next to engineer with back and head braced against armor plate. Fasten safety belt.

e. Throw one-man raft from escape hatch and proceed to the right raft.

5. Navigator

a. Acknowledge ditching order.

b. Remove flak suit, parachute. Remove one-man raft from parachute harness. Wear flak helmet, emergency kit, Mae West and gloves.

c. Calculate position, course, altitude, and ground speed for radio operator to transmit.

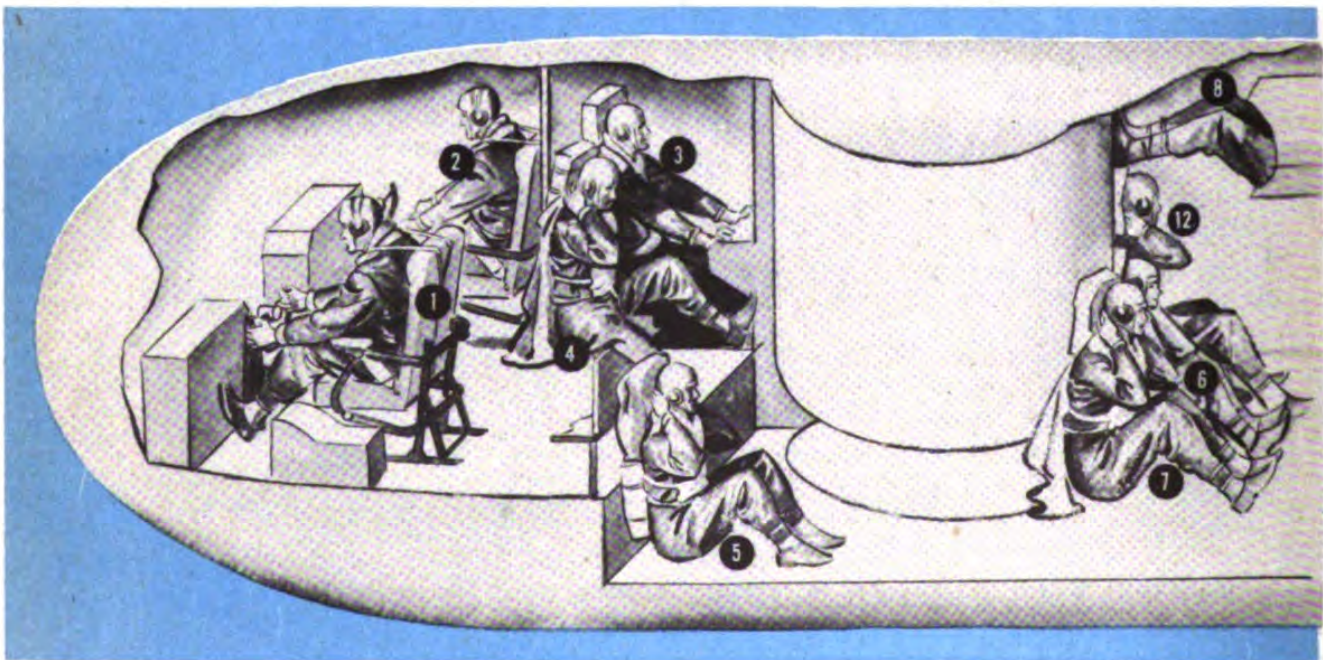

d. Remove flare kit, tuck into clothing or waterproof bag.

e. Stow chair in bomb bay. Aid in stowing all loose equipment in cabin.

f. Pass fire axe from engineer's panel to gunner.

g. Remove table corner, and assume position on floor with back braced against parachute and seat cushions placed against navigator's cabinet.

h. Place one-man raft in lap.

i. Throw raft from engineer's escape hatch, exit and proceed to right wing.

6. Radio Operator

a. Acknowledge ditching order.

b. Remove parachute. Wear emergency kit, flak helmet, Mae West and gloves.

c. Check IFF setting.

d. Continue to send emergency signals. On comand of the copilot, clamp down transmitter key.

e. Assume sitting position on lower turret with back and head braced against the upper. Brace legs against bulkhead. Fasten safety belt. Place one-man raft under flexed knees.

f. When forward movement of airplane has stopped, pull both life raft release handles.

g. Throw one-man raft from astrodome, exit and proceed to right raft.

7. Top Gunner

a. Acknowledge ditching order.

b. Wear flak helmet, emergency kit, Mae West, and gloves.

c. Take one-man raft and go forward through tunnel to forward cabin. Remove astrodome by pulling release cord. If release cord does not function, remove the astrodome with an axe.

d. Insure that all loose equipment has been stowed in the bomb bay.

e. Install bulkhead door braces.

f. Assume ditching position on lower turret with back and head braced against the upper. Fasten safety belt. Place one-man raft under flexed knees. Verify that life raft handles have been pulled.

g. Throw raft through astrodome, exit and proceed to left raft.

8. Right Gunner

a. Acknowledge ditching order.

b. Wear emergency kit, Mae West, helmet and gloves.

c. Proceed to forward end of tunnel.

d. Aid in installing bulkhead braces.

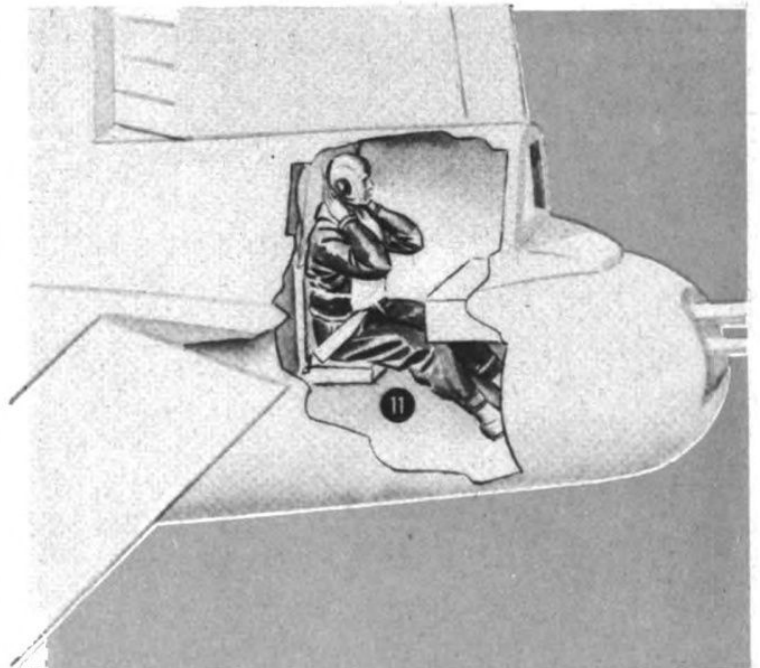

RESTRICTED

e. Assume a reclining position in tunnel. Brace feet against the four-gun turret and keep the knees flexed.

f. Exit from astrodome. Receive equipment passed out by radio operator and top gunner.

g. Proceed to left wing.

9. Left Gunner

a. Acknowledge ditching order.

b. Report progress in gunners' compartment to airplane commander.

c. Install bulkhead door braces.

d. Proceed to rear unpressurized section with radar operator. Take parachutes, one-man raft, and seat cushions for padding.

e. Use fire axe to chop away camera supports. Jettison all loose equipment. Open escape hatch.

f. Insure that the extra life raft and emergency kits are securely lashed down or are stowed in the radar compartment.

g. Place parachute and seat cushions against left side of bulkhead to form a padded seat. Assume sitting position with head and back securely braced against bulkhead. Fasten safety belt.

h. Wear flak helmet, emergency kit, Mae West, and gloves.

i. Throw out one-man rafts, exit through escape hatch and proceed to left wing.

10. Radar Operator

a. Acknowledge ditching order.

b. Take parachute and seat cushions to rear unpressurized compartment.

c. Aid in removing camera supports and loose equipment. Open escape hatch.

d. Assume sitting position on right side of bulkhead door. Pad back and sides with parachute, cushions, and one-man raft. Fasten safety belt.

e. Wear flak helmet, emergency kit, Mae West, and gloves.

f. Proceed to left wing.

11. Tail Gunner

a. Acknowledge ditching order.

b. Remove parachute. Wear flak helmet, emergency kit, Mae West, and gloves.

c. Jettison escape hatch and sight.

d. Throw out one-man raft, exit, and proceed to left raft.

12. Extra Passenger

a. Aid in stowing equipment.

b. Take position in radio operator's seat, safety belt fastened, facing aft with back braced against turret, or in tunnel beside gunner, feet braced against turret, knees flexed, or in unpressurized section braced against knees of the left gunner.

B-29'S NOT EQUIPPED WITH FOUR-GUN TURRETS

Crew Procedures

The procedure described herewith is to be followed during all ditchings. This procedure was disseminated by Hq. AAF, AC/AS-3, Requirements Division, as of December 1945, with a notation that Air Force commanders are authorized to make procedure revisions necessitated by special aircraft equipment installation, but that other changes in procedures must be submitted for coordination and approval, complete with diagrams illustrating the positions affected.

1. Airplane Commander

a. Give warning: **"Prepare for ditching in . . . minutes."** Give six short rings on alarm bell. Turn IFF emergency switch ON.

b. Open and secure window; jettison if possible.

c. Remove flak suit, flak helmet, parachute. Remove one-man raft from parachute harness but leave in seat. Wear helmet, emergency kit, Mae West, and gloves. Fasten safety belt and shoulder harness.

d. Radio other aircraft of your distress and then turn to interphone.

e. Give order: **"Open emergency exits and stow loose equipment."**

f. Lower seat and push rearward.

g. Give order: **"Stations for ditching; impact in . . . seconds."**

h. Give order: **"Prepare for impact"** just before contact is expected, and send one long ring on alarm bell.

i. **Keep knees flexed at impact.**

j. Check to see that crew is clear; throw one-man life raft from window, escape through left window and inflate Mae West.

2. Copilot

a. Relay airplane commander's instructions over interphone. Receive acknowledgements from crew. Inform airplane commander: **"Crew notified."**

b. Open window and secure or jettison it.

c. Remove flak suit, flak helmet, and para-

chute. Remove one-man raft from parachute harness but leave it in seat. Wear helmet, emergency kit, Mae West, and flying gloves. Fasten safety belt and shoulder harness.

d. Stand by on interphone to relay airplane commander's orders.

e. At an altitude of 300 to 500 feet order radio operator to take his ditching station.

f. **Keep knees flexed at impact.**

g. Take first-aid kit stored above engineer's seat, throw out one-man raft and exit through right window. Inflate Mae West and proceed to right wing.

3. Bombardier

a. Acknowledge in turn (eighth): **"Bombardier ditching."**

b. Remove flak suit, flying boots and loosen shirt collar. Keep flak helmet on. Wear flying gloves. Remove parachute at or below 1500 feet.

c. Destroy bombing data. Dismount bomb-sight and stabilizer and pass back to rear of forward pressurized compartment to be jettisoned through bomb bay or nosewheel well.

d. Open bomb bay doors and jettison bombs. (Do not open bomb bay doors if you have no bombs.) Remove brace for nosewheel crank. Aid in jettisoning loose equipment. Close door to bomb bay. Install ditching braces.

e. Slip aeronautic first-aid kit over left wrist, and wrist lanyard of one-man raft over right wrist. Assume seated position facing aft, next to flight engineer, back and head cushioned with own parachute against partition behind copilot. Hold one-man raft against chest with arms. Brace right foot across aisle.

f. Exit second through flight engineer's escape hatch. Throw one-man raft out, keeping lanyard on wrist. Climb atop cabin, inflate life vest, and proceed to right wing. Assist in securing raft and equipment and board right raft.

4. Flight Engineer

a. Acknowledge in turn (seventh): **"Flight engineer ditching."**

RESTRICTED

b. Remove flak suit, flying shoes and loosen collar. Wear flying gloves. At 1500 feet remove parachute and fasten safety belt.

c. On command, open front emergency hatch and acknowledge to copilot: "**Front hatch open.**" Jettison it together with other, loose equipment into front bomb bay or nosewheel well. If required to remain at station, pass hatch to navigator.

d. Receive the emergency signal kit from the navigator and tie its line on arm.

e. Remain at regular station, facing aft, back and shoulders cushioned with parachute against partition behind copilot, safety belt fastened, hands hard against control stand.

f. Exit first, backwards, through front escape hatch, carrying signal kit and one-man raft. Climb atop cabin, inflate life vest, and proceed to right wing. Assist in securing life raft and equipment.

5. Navigator

a. Acknowledge in turn (sixth): "**Navigator ditching.**"

b. Remove flak suit, flying shoes and loosen collar. Leave flak helmet on. Wear gloves. At 1500 feet remove parachute harness.

c. Calculate position, course, altitude, and groundspeed for radio operator to transmit. Give radio operator accurate Loran Line. Give airplane commander surface wind strength. Gather essential maps and navigational equipment into waterproof bag or tuck inside clothing.

d. Destroy classified documents. Jettison all drift signal flares through release tube. Assist in jettisoning all loose equipment from front compartment. Place own parachute against end of control panel. Place two one-man rafts along wheel well step for cushioning.

e. Lie on side, facing aft, against nosewheel well step, head toward engineer's control panel and back braced firmly and well padded, knees drawn up and feet flat against step. Pick up one-man raft, exit third from engineer's escape hatch, throwing life raft out first with lanyard slipped on wrist.

f. Climb atop cabin, inflate life vest and proceed to left wing. Assist the airplane commander in securing raft.

6. Radar Observer

a. Acknowledge in turn (fifth): "**Radar observer ditching.**"

b. Remove flak suit and winter flying shoes. Keep flak helmet on. Loosen collar. At 1500 feet remove parachute and pass it to navigator.

c. Remove thermos bottle and bracket, or other equipment from back of flight engineer's control stand for radio operator's ditching station. Prepare all loose equipment for jettisoning.

d. Grasp leather thong below astrodome and pull sealing strip away. If astrodome does not fall free, jerk sharply on center stud. If difficulty is experienced, chop out with axe. Acknowledge to copilot: "**Astrodome removed.**" Remove and jettison radar indicator. Assist in jettisoning other loose equipment.

e. Pull chair full forward, place parachute along back edge of table, rest head in arms on table top, chest against padding, feet braced against step, safety belt fastened.

f. Pull life raft release handles at tunnel entrance. Exit first through astrodome. Inflate life vest and proceed to left wing. Assist airplane commander in securing raft and equipment. Board left raft.

7. Radio Operator

a. Acknowledge in turn (fourth): "**Radio operator ditching.**"

b. Remove flak suit, flying shoes and loosen shirt collar. Keep flak helmet on. Wear flying gloves. At 1500 feet remove parachute and place against flight engineer's control panel.

c. Transmit position, course, altitude and groundspeed as received. Relay fix or bearing obtained to navigator.

d. Destroy classified materials. Continue to send emergency signals. On command from airplane commander, screw down transmitter key.

e. Take sitting position facing aft against flight engineer's control stand, back well braced and cushioned, hands behind head, knees flexed.

f. Exit second through astrodome. Inflate life vest and proceed to right wing. Assist in securing raft and equipment. Board right raft.

8. Left Scanner

a. Acknowledge in turn (third): "**Left scanner ditching.**"

b. Remove flak suit and winter flying shoes. Loosen collar. Keep flak helmet on. Do not remove parachute until you have reached 1500 feet.

c. Make sure pressure bulkhead door to rear bomb bay is securely closed. Fasten ditching braces over door. Proceed to rear unpressurized compartment, closing securely door of aft pressurized compartment.

d. Remove rear escape hatch and jettison. Assist in dismounting and jettisoning camera and other equipment. Jettison through main entrance door. Make certain that main entrance door is securely latched. Stow all emergency equipment against rear pressure bulkhead just beneath the door. (Note: leave the E-K kit and extra life raft in the rear pressurized compartment.)

e. Take ditching station on left side of rear pressure bulkhead door, seated, facing aft with back and head well cushioned. Cushion side of body against battery.

f. After airplane comes to rest, exit first through rear escape hatch, inflate life vest and stand by to help with equipment. Assist the waist gunner. Proceed atop fuselage to left wing. Board left life raft.

9. Right Scanner

a. Acknowledge in turn (second): "**Right scanner ditching.**"

b. Turn IFF emergency switch ON. Remove flak suit and winter flying shoes. Leave flak helmet on and loosen collar. Do not remove parachute until aircraft has reached 1500 feet.

c. Gather cushions, one-man rafts and other padding material and proceed to rear unpressurized section. Dismount camera.

d. Jettison camera and all loose equipment. Stow emergency equipment.

e. Assume seated position, facing aft, on right side of pressure bulkhead door, cushioned and braced against bulkhead and avoiding the pressure bulkhead door.

f. After plane comes to rest, exit second through escape hatch. Inflate life vest. Carry-

ing equipment, proceed atop fuselage to right wing. Board the right raft.

10. Tail Gunner

a. Acknowledge in turn (first): "**Tail gunner ditching.**"

b. Remove flak suit and winter flying shoes. Keep flak helmet on. Loosen collar. Do not remove parachute until ordered to station.

c. Expend remaining ammunition.

d. Jettison tail gunner's escape hatch and loosen equipment.

e. Remain in seat, facing aft, back and head cushioned against back or seat and compartment bulkhead, knees flexed.

f. After plane comes to rest, exit through escape hatch to left horizontal stabilizer. Inflate life vest and proceed to left wing. Assist gunners to escape from rear hatch if possible. Board the left raft.

11. Extra Passenger (Forward)

a. Acknowledge to copilot: "**Forward observer ditching.**"

b. Remove flak suit, flying boots and loosen collar. Wear flying gloves. Do not remove parachute until aircraft reaches 1500 feet.

c. Aid in jettisoning equipment.

d. On order from copilot, assume seated position in front of radio operator, sitting bob-sled style, with back well up against the radio operator's chest, and head supported in his interlaced hands.

e. Exit second through astrodome and proceed to left wing.

12. Extra Passenger (Rear)

a. Acknowledge in turn: "**Rear observer ditching.**"

b. Remove flak suit, flying boots and loosen collar. Wear flying gloves. Remove parachute only when the aircraft has reached 1500 feet.

c. Proceed to rear unpressurized section and aid in jettisoning and stowing equipment.

d. Take ditching position in front of right scanner, seated bob-sled style, facing aft with back up against chest of scanner and head supported by his interlaced hands.

e. Exit second through rear escape hatch and proceed to right wing.

BAILOUT

As airplane commander you must decide whether or not bailout is necessary. Give the crew the warning when an emergency first appears. If it develops that you can handle the emergency safely without bailout, you can cancel the preparation order later.

Bailout signals are as follows:

Prepare to Bail Out: Three short rings on the alarm bell. Also warn the crew by interphone and obtain acknowledgment from each crew member.

Bail Out of the Airplane: One long sustained ring.

Climb to a safe altitude for bailout, if necessary.

Teach your crew **not to leave the airplane until ordered to bail out!** Each crew member must know when, where, and how he is to leave the airplane. The only way to make sure that abandonment will be carried out safely and properly is to go through frequent bailout drills on the ground. Don't forget to simulate the destruction of designated instruments by specific crew members.

The illustration shows the exit and the escape hatch used by each crew member. Have each crew member learn his part and practice the coordinated procedure with the whole crew.

It is the responsibility of the airplane commander to formulate a bailout sequence for his particular crew and drill them until the procedure becomes automatic.

The forward bomb bay is an alternate exit for the men in the forward compartment. The center gunners use the rear exit door as an alternate exit. The radar operator's alternate exit is the aft bomb bay. The tail gunner uses the hatch in his compartment as alternate exit. Over water, he gets his individual life raft from the unpressurized section and goes out the rear exit door.

When bailout warning is given over water, each man removes the individual life raft pack

from its position near his station, and snaps it onto his parachute harness. He opens the corner of raft pack cover, pulls out end of lanyard, runs it **under his parachute harness** and snaps it onto the ring of his life vest waist strap. Crew members should check each other to see that all straps and packs are secure and properly adjusted.

Raft packs for airplane commander and copilot are located behind the armor plate just back of respective seats. Flight engineer's raft is strapped to cabin roof between front upper hatch and aisle dome light. Rafts for navigator, radio operator, and bombardier are stowed on floor between lower forward turret and wheel well step. Right, left, and top gunners' rafts are fastened to the floor in the left forward section of their compartment. Radar operator's raft is strapped to left wall just aft of and level with rear ditching hatch. Tail gunner's raft is strapped to right wall just aft of rear bottom turret.

To bail out, face direction of flight when possible and roll out from a crouching position.

Note: If you find that any part of this procedure cannot be applied to your particular airplane because of different stowage of equipment, loading, or any other reason, **change the drill accordingly.** With the help of your Personal Equipment Officer, work out a bailout drill which you know you can use safely in your own airplane.

Nosewheel Well

Recommended procedure for bailing out of the nosewheel well of the B-29 is as follows: Jump off the flight deck through the well in a feet-first position, facing aft, with hands in a protective attitude in front of the chest to prevent hitting the rear wall of the well.

Note: If the autopilot is being used to hold the airplane steady during bailout, the last man out (normally the airplane commander) will direct the airplane away from congested areas and retard the throttle to approximately 20" Hg.

Bailout Exit Diagram

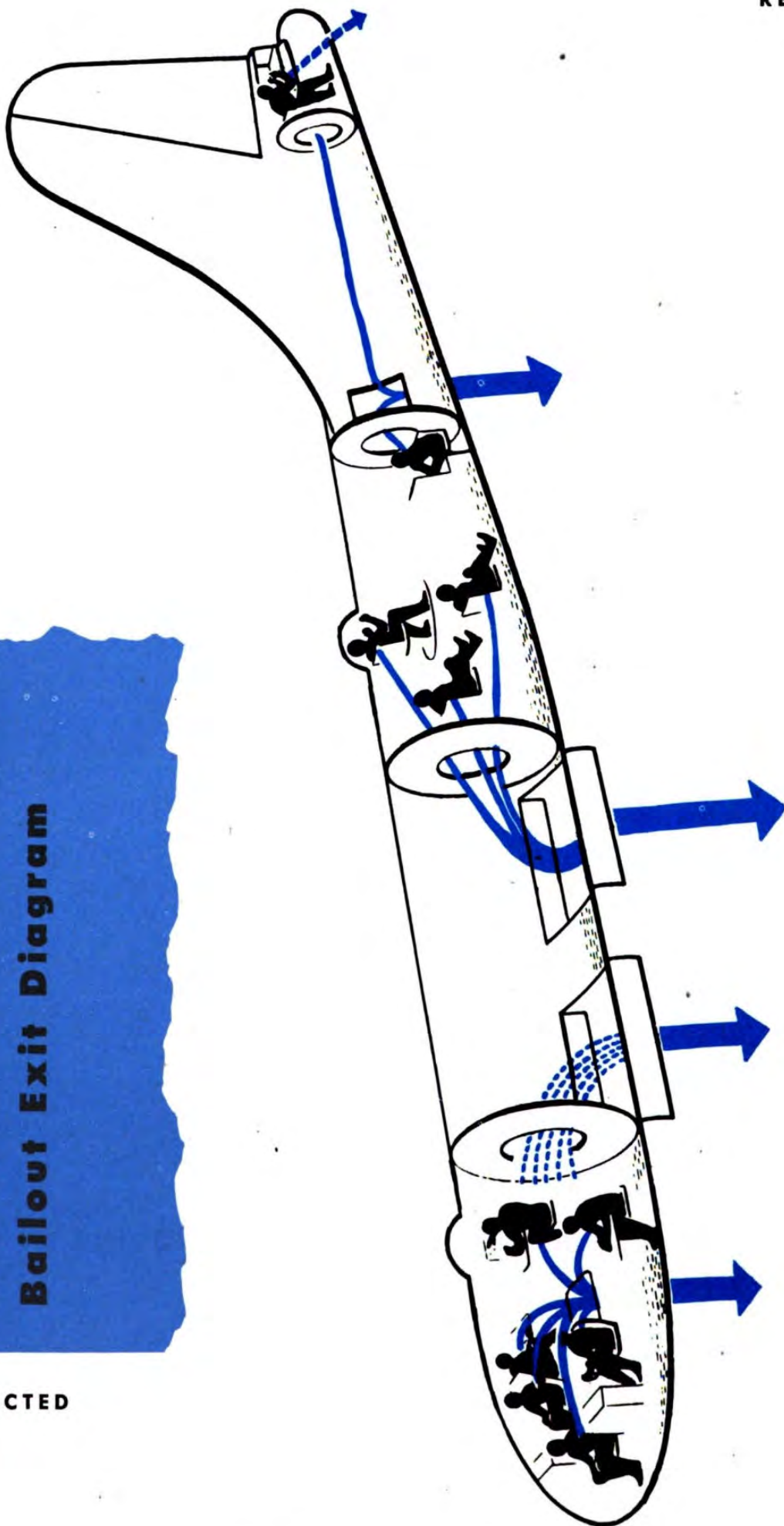

RESTRICTED

TEACH YOUR CREW NOT TO LEAVE THE AIRPLANE UNTIL ORDERED OUT.

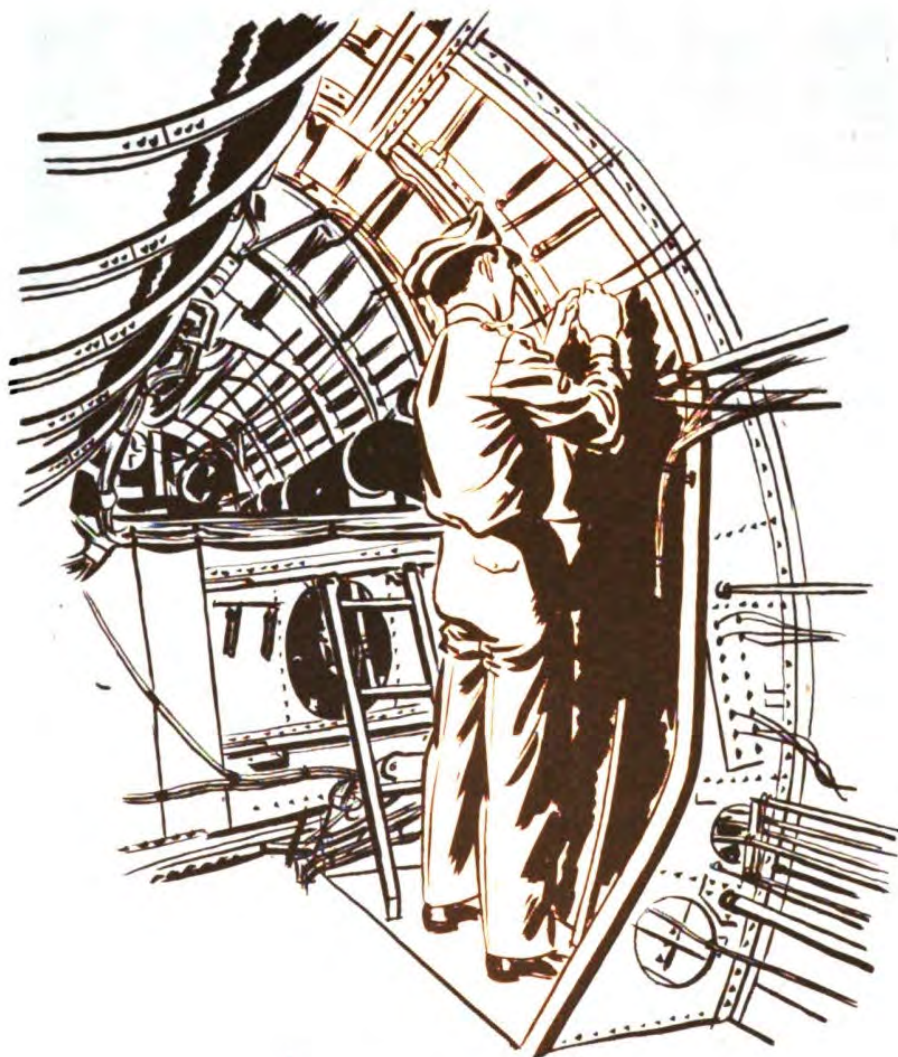

SYSTEMS AND TROUBLE SHOOTING IN FLIGHT

CURTISS ELECTRIC PROPELLER SYSTEM

data

Propeller type	C644S-A24
Propeller diameter	16'8"
Full decrease rpm angle	57°
Full increase rpm angle	17°
Full reverse pitch	-15.7°
Feather angle	84.7°

Description

The Curtiss propeller installed on the B-29 is provided with hollow steel blades and incorporates an automatic synchronizer control system, an auxiliary selective fixed pitch control and reverse thrust control for landing.

The electrical energy for changing the propeller blade angle passes through brushes mounted on the rear base of the propeller hub, and to the electric blade angle change motor through connector leads passing through the hub. Electrical energy directed by either the automatic synchronizer or the selective fixed pitch control to the electric motor causes the blade angle to increase or decrease as required. The automatic synchronizer control system accomplishes synchronization of the four engines.

The synchronizer incorporates a master motor which drives four contactors, one for each propeller. Each contactor is electrically connected to an alternator (a 3-phase AC generator) mounted on the governor drive pad of each engine. The rpm of the master motor, selected by the airplane commander or copilot, maintains constant rpm at the selected setting. The contactors compare the speed of their respective engines, as indicated by the alternators, to the speed of the master motor and direct electrical energy to the blade angle change mechanism of the propellers for maintaining the desired rpm.

In automatic operation you select the desired engine rpm by rotating the master rpm control located on the aisle stand. The rpm at which the engines will synchronize is indicated by the

master tachometer located on the copilot's instrument panel.

The propellers are controlled by switches located on the aisle stand and the reverse-actuating switches located near the throttles at the airplane commander's and copilot's stations. To operate the propellers automatically, place the master motor switch in the ON position, turn the master rpm control until the desired rpm reading is indicated by the master tachometer. Place the selector switch for each propeller in the AUTOMATIC position and at the same time check to see that the propeller circuit breakers, located just below the selector switches, are in the ON position, and that the auto-operation tel-lights just above the selector switches come on. The circuit breakers are in the automatic and selective fixed pitch circuits to protect them in the event of an electrical overload. You can reset them by pushing in on the button until the red and white luminous bands are no longer visible. By placing the selector switch to FIXED PITCH position, you can use selective fixed pitch, an auxiliary control. Then adjust engine rpm by holding the switch in the INCREASE or DECREASE RPM position as required. Four feather switches under plastic guards are installed on the aisle stand for feathering the propellers. Four voltage boosters are incorporated within the system for speeding up the blade angle change for feather, reverse and return from reverse.

Reverse pitch is provided for use as a brake during landing. Propellers may be reversed either in pairs (i.e., inboards or outboards), or all four simultaneously.

Before Starting Engines

The following procedures must be worked into the proper sequence of your Before Starting Engines checklist whenever you are operating B-29 Curtiss electric propellers.

1. Master synchronizer switch—ON. Turn on the switch early enough to give the master synchronizer time to warm up.

2. Propeller selector switches — AUTOMATIC. Check position of all four switches to be sure they are in AUTOMATIC position.

3. Propeller circuit breakers—ON. As you check selector switches, check circuit breakers also to be sure they are in ON position.

Before Takeoff

With Curtiss propellers on your airplane use the following procedure during prop check at the engine run-up. These procedures check the fixed pitch, reverse, and automatic operation of your props. The putt-putt and the generators must be on for the checks. Leave generators on throughout flight and landing roll when you have Curtiss electric propellers.

1. With all four throttles at 1500 rpm hold No. 1 propeller selector switch in DECREASE RPM position until prop speed drops approximately 200 rpm.

2. Then place switch in FIXED PITCH position and check to see that the rpm remains at 1300.

3. Place switch in INCREASE RPM position. As soon as propeller has increased approximately 100 rpm, flip the switch to AUTOMATIC position and check to see that the rpm returns to 1500.

4. Repeat the procedure on engines No. 2, 3 and 4.

Note: The foregoing procedures are a check on fixed pitch operation. This check can be omitted by the airplane commander during engine run-up provided he sees that the flight engineer makes the fixed pitch check during pre-flight inspection.

5. Place the inboard propeller pre-selector switch to REVERSE.

6. Depress actuating switch just above airplane commander's throttles. Note that the engine rpm goes from 1500 to approximately 1800

and then returns to 1500, at which time props are in reverse pitch.

7. Return the pre-selector switch to NORMAL position. This causes propellers to return to NORMAL angle. Note that engine rpm again increases as the propeller blades pass through flat pitch and that the inboard propeller tellights flash on when the propellers reach low angle. The engine tachometers return to the original rpm.

8. Repeat the procedure on the outboard propellers, this time having the copilot depress the actuating switch under his throttles.

9. When props are again in NORMAL pitch check automatic operation as follows:

Turn the master rpm control in a counterclockwise direction until the engine tachometers indicate a drop of approximately 200 rpm. All tachometers should show stable, uniform readings.

10. Turn the master synchronizer control switch to OFF. In this position the engines should remain constant at the same rpm.

11. Turn the master synchronizer control switch to ON and turn the control clockwise to takeoff position. The engine tachometers should return to 1500 rpm.

Use of Reverse Pitch

Reverse pitch can be used as a brake during landings. Always remember to notify copilot before landing which engines you are going to use in reverse pitch. Do not use reverse pitch on the ground to back up the airplane because the nosewheel does not have full castering and because the engines heat up excessively without the cooling effect of ram air.

The following is the airplane commander's operating procedure for using reverse pitch:

1. When the main gear touches the ground, place the reverse-normal switches in REVERSE position.

2. When the nosewheel touches, with the throttles in idle position, push the reverse actuating switch. There is a reverse actuating switch on both airplane commander's and copilot's side.

3. Be ready to nurse the throttles to keep the engines from stalling after the propeller blades

RESTRICTED

have gone through the flat blade angle. You can tell when the blades have gone through flat pitch by the sound, engine tachometer indication, and manifold pressure. Then push the throttles forward until you get a desired rpm indication on the engine tachometers, not more than 35" to prevent overspeeding of props.

Caution: Have the flight engineer watch the tachometers for indication of overspeeding props.

4. To return the propeller from reverse to normal pitch, operate the engines at idling and place the reverse-normal switch in NORMAL position. When the reverse tel-lights go out the blades have reached the low pitch angle and you may resume normal operation.

Note: In using throttles for directional control remember that throttle action is the reverse of normal procedure. If you are rolling to the left, advance right throttle or throttles. If rolling to the right, advance left throttle or throttles.

Before leaving the airplane turn master motor switch to OFF position.

Feathering

Feathering procedure for Curtiss electric propellers is approximately the same as for hydromatic props except that the feather switch should remain in the FEATHER position as long as the propeller is to remain feathered. It should not be returned to NORMAL.

The following is unfeathering procedure:

1. Move prop selector switch of the feathered props to FIXED PITCH position.

2. Return the feather switch to NORMAL position.

3. Hold the selector switch to INCREASE RPM position until the engine reaches 600 rpm or more, but in any case not more than 1000 rpm.

4. Start and warm up the windmilling engine.

5. When the engine reaches proper operating temperature flip the selector switch to AUTOMATIC position. The engine then increases rpm automatically until it is synchronized with the other engines.

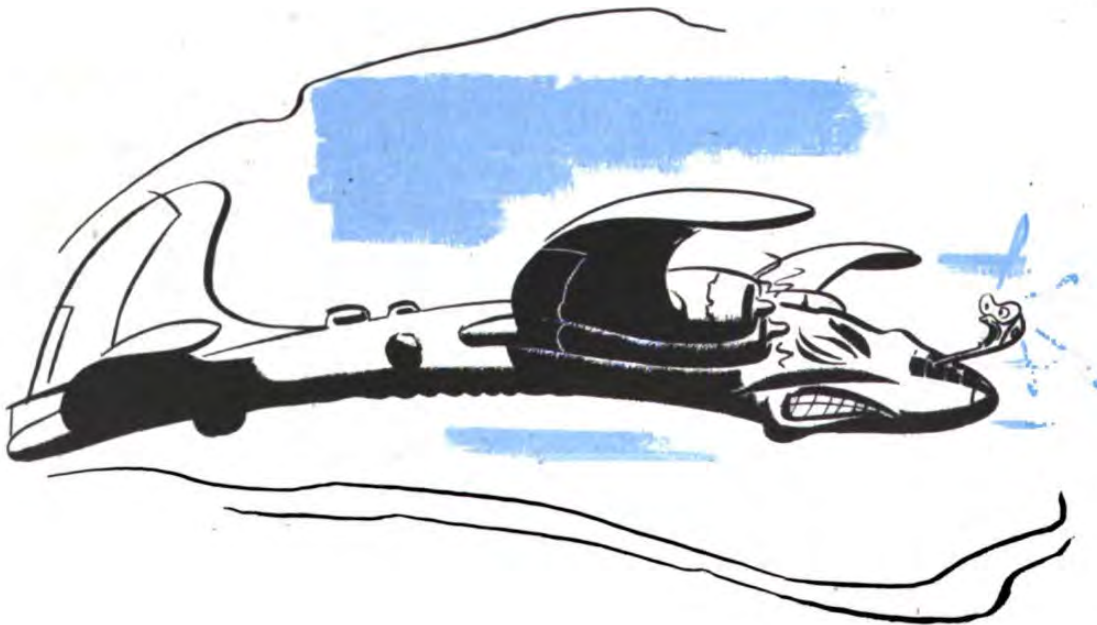

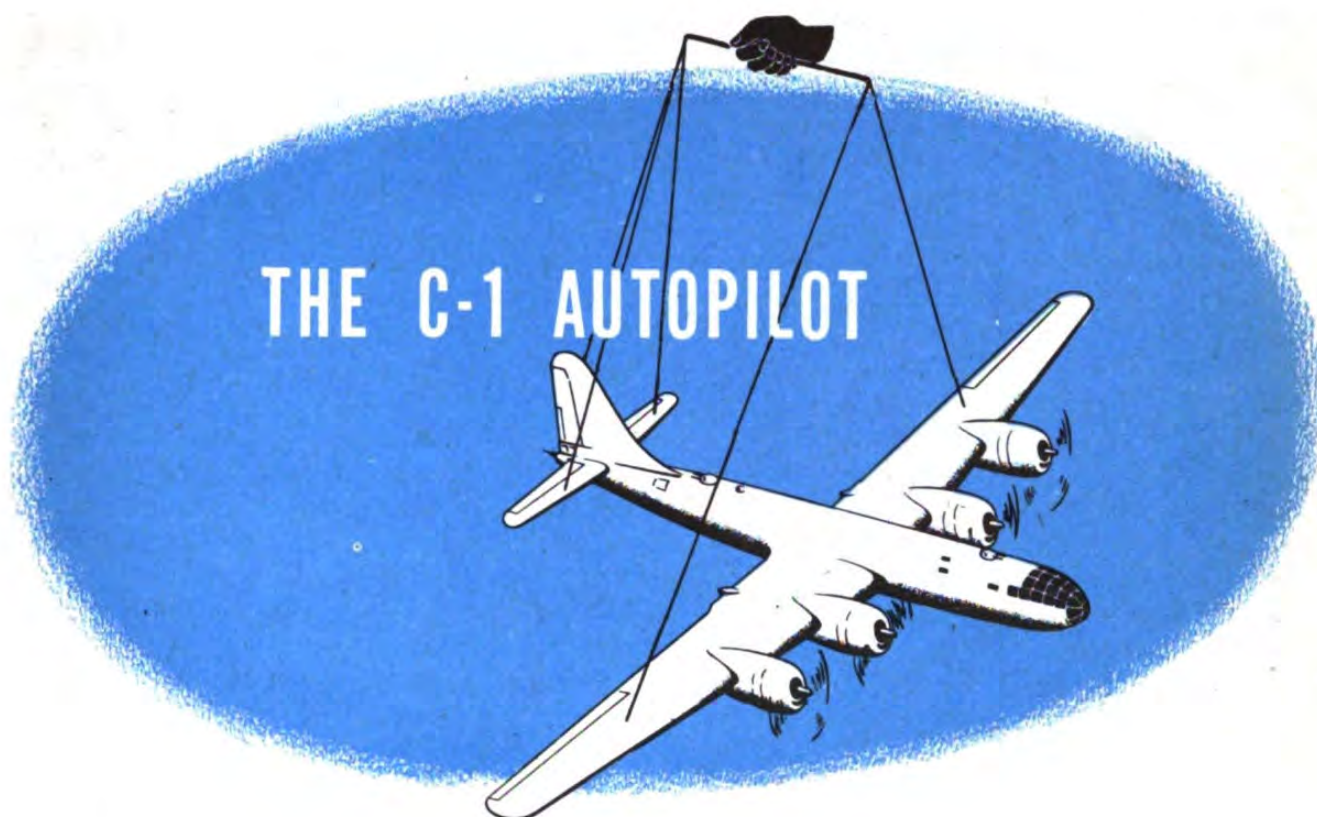

The C-1 autopilot is an electromechanical robot which automatically controls the airplane in straight and level flight, or maneuvers the airplane in response to the fingertip control of the human pilot or bombardier.

Actually, the autopilot works in much the same way as the human pilot in maintaining straight and level flight, in making corrections necessary to hold a given course and altitude, and in applying the necessary pressure on the controls to turn, bank, etc. The difference is that the autopilot acts instantaneously and with a precision that is not humanly possible.

The precision of even the most skillful human pilot is limited by his own reaction time; i.e., the interval between his perception of a certain condition and his action to correct or control it. Reaction time itself is governed by such human fallibilities as fatigue, inability to detect errors the instant they occur, errors in judgment, and muscle coordination.

The autopilot, on the other hand, detects flight deviations the instant they occur, and

just as instantaneously operates the controls to correct the deviations. Properly adjusted, the autopilot will neither overcontrol nor undercontrol the airplane, but will keep it flying straight and level with all primary control surfaces operating in full coordination.

The C-1 autopilot consists of various separate units electrically interconnected to operate as a system. The operation of these units is explained in detail in AN 11-60AA-1. A general over-all understanding of their functions and relation to each other can be acquired by studying the illustration on next page.

Suppose that rough air turns the airplane away from its established heading. The gyro-operated directional stabilizer (1) in the bombardier's compartment detects this deviation and moves the directional panel (4) to one side or the other, depending upon the direction of the deviation.

The directional panel contains two electrical devices, the banking pot (5) and the rudder pick-up pot (6), which send signals to the

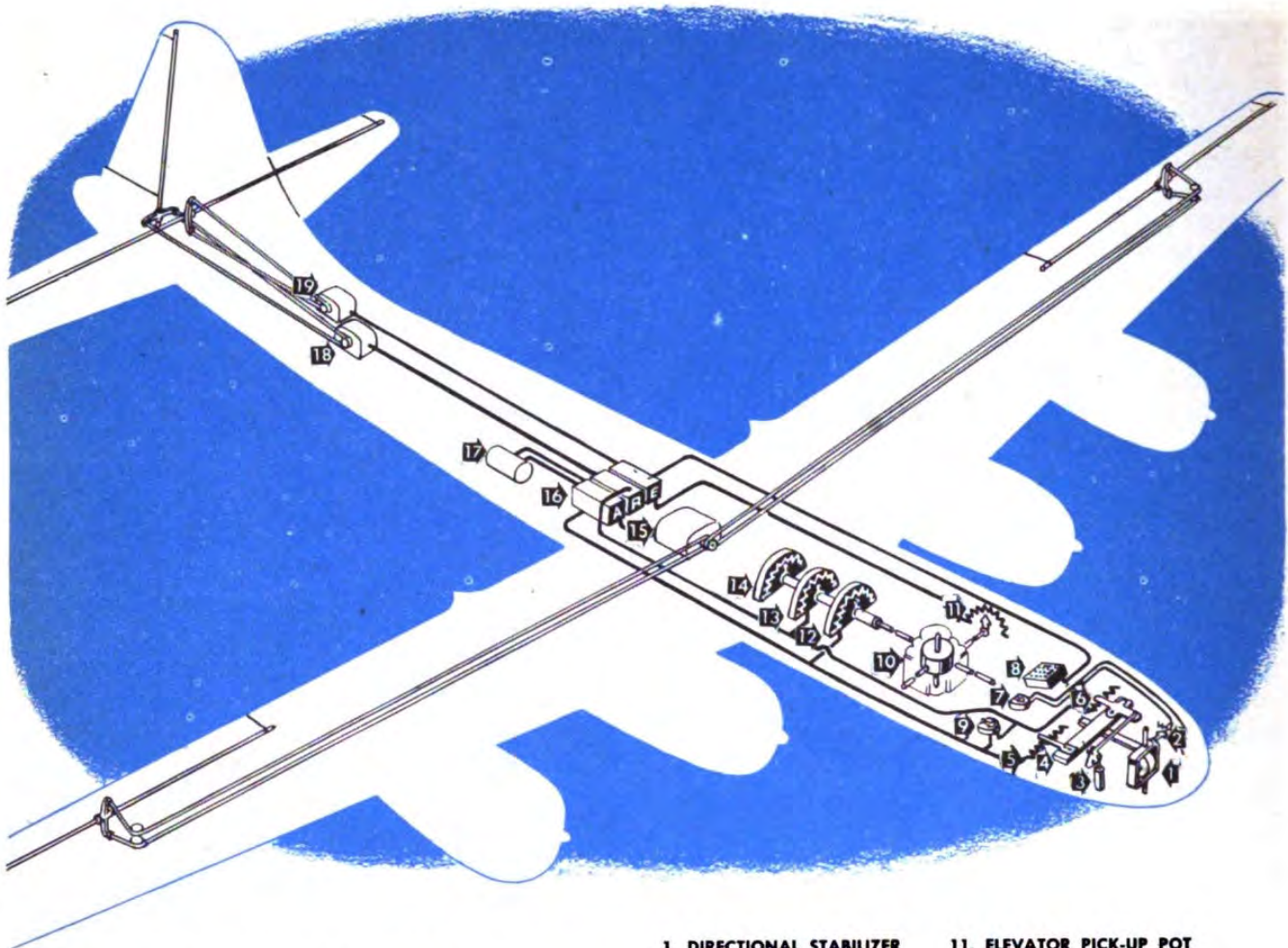

C-I AUTO PILOT

(SCHEMATIC DRAWING . . . DOES NOT SHOW CORRECT LOCATION OR PROPORTION OF UNITS)

- | | |
|----------------------------|--------------------------|
| 1. DIRECTIONAL STABILIZER | 11. ELEVATOR PICK-UP POT |
| 2. P. D. I. POT | 12. AILERON PICK-UP POT |
| 3. DASH POT | 13. SKID POT |
| 4. DIRECTIONAL PANEL | 14. UP-ELEVATOR POT |
| 5. BANKING POT | 15. AILERON SERVO |
| 6. RUDDER PICK-UP POT | 16. AMPLIFIER |
| 7. P. D. I. | 17. ROTARY INVERTER |
| 8. AUTOPILOT CONTROL PANEL | 18. RUDDER SERVO |
| 9. TURN CONTROL | 19. ELEVATOR SERVO |
| 10. VERTICAL FLIGHT GYRO | |

aileron and rudder section of the amplifier (16) whenever the directional panel is operated. These signals are amplified and converted (by means of magnetic switches or relays) into electrical impulses which cause the aileron and rudder servo units (15 and 18) to move the ailerons and rudder of the airplane the proper direction and amount to turn the airplane back to its original heading.

Similarly, if the nose of the airplane drops, the vertical flight gyro (10) detects the vertical deviation and operates the elevator pick-up pot (11) which sends an electrical signal to the elevator section of the amplifier. The signal is

amplified and relayed in the form of electrical impulses to the elevator servo unit (19) which in turn raises the elevators the proper amount to bring the airplane to level flight.

If one wing drops appreciably, the vertical flight gyro operates the aileron pick-up pot (12), the skid pot (13), and the up-elevator pot (14). The signals caused by the operation of these units are transmitted to their respective (aileron, rudder, and elevator) sections of the amplifier. The resulting impulses to the aileron, rudder, and elevator servo units cause each of these units to operate its respective control surface just enough to bank and turn

the airplane back to the level-flight attitude.

When the human pilot wishes to make a turn, he merely sets the turn control knob (9) at the degree of bank and in the direction of turn desired. This control sends signals, through the aileron and rudder sections of the amplifier, to the aileron and rudder servo units which operate ailerons and rudder in the proper manner to execute a perfectly coordinated (non-slipping, non-skidding) turn. As the airplane banks, the vertical flight gyro operates the aileron, skid, and up-elevator pots (12, 13, 14). The resulting signals from the aileron and skid pots cancel the signals to the aileron and rudder servo units to streamline these controls during the turn.

The signals from the up-elevator pot cause the elevators to rise just enough to maintain altitude. When the desired turn is completed, the pilot moves the turn control back to zero and the airplane levels off on its new course. A switch in the turn control energizes the directional arm lock on the stabilizer, which prevents the stabilizer from interfering with the turn by performing its normal direction-correcting function.

A remote turn control may be provided for the radar operator. It is controlled by the "control transfer" knob on the autopilot control panel. The autopilot control panel (8) provides the pilot with fingertip controls by which he can conveniently engage or disengage the system, adjust the alertness or speed of its responses to flight deviations, or trim the system for varying load and flight conditions.

The pilot direction indicator, or PDI (7), is a remote indicating device operated by the PDI pot (2). When the autopilot is used, the PDI indicates to the pilot when the system and airplane are properly trimmed. Once the autopilot is engaged, with PDI centered, the autopilot makes the corrections automatically.

The rotary inverter (17) is a motor-generator unit which converts direct current from the airplane's battery into 105-cycle alternating current for operation of the autopilot.

After Takeoff

1. Turn on the master switch.

2. Ten minutes later, turn on PDI switch (and servo switch, if separate).

3. Fifteen minutes after turning on the master switch, trim the airplane for level flight at cruising speed by reference to flight instruments.

4. Have the bombardier disengage the autopilot clutch, center PDI and lock it in place by depressing the directional control lock. The PDI is held centered until the pilot has completed the engaging procedure. Then the autopilot clutch is re-engaged, and the directional arm lock released.

Alternate method: Center the PDI by turning the airplane in direction of the PDI needle. Then resume straight and level flight.

5. Engage the autopilot. Put out aileron tell-tale lights with the aileron centering knob, then throw on the aileron engaging switch. Repeat the operation for rudder, then for elevator.

6. Make final autopilot trim corrections with centering knob if necessary to level wings or center PDI.

Caution

NEVER ADJUST MECHANICAL TRIM TABS WHILE THE AUTOPILOT IS ENGAGED

Flight Adjustments and Operation

After the C-1 autopilot is in operation, carefully analyze the action of the airplane to make sure all adjustments have been properly made for smooth, accurate flight control.

When both tell-tale lights in any axis are extinguished, it is an indication the autopilot is ready for engaging in that axis.

Before engaging, each centering knob is used to adjust the autopilot control reference point to the straight and level flight position of the

corresponding control surface. After engaging, centering knobs are used to make small attitude adjustments.

Sensitivity is comparable to a human pilot's reaction time. With sensitivity set high, the autopilot responds quickly to apply a correction for even the slightest deviation. If sensitivity is set low, flight deviations must be relatively large before the autopilot will apply its corrective action.

Ratio is the amount of control surface movement applied by the autopilot in correcting a given deviation. It governs the speed of the airplane's response to corrective autopilot actions. Proper ratio adjustment depends on airspeed. If ratio is too high, the autopilot will overcontrol the airplane and produce a ship hunt; if ratio is too low, the autopilot will undercontrol and flight corrections will be too slow. After ratio adjustments have been made, centering may require readjustment.

To adjust **turn compensation**, have bombardier disengage autopilot clutch and move engaging knob to extreme right or extreme left. Airplane should bank 18° as indicated by artificial horizon. If it does not, adjust aileron compensation (bank trimmer) to attain 18° bank. Then, if turn is not coordinated, adjust rudder compensation (skid trimmer) to center inclinometer ball. (Best operation may be had with ball slightly high on B-29 airplanes.) Do not use aileron or rudder compensation knobs to adjust coordination of turn control turns.

The **turn control** is used by the airplane commander to turn the airplane while flying under automatic control. To adjust turn control first make sure turn compensation adjustments have been properly made, then set turn control pointer to beginning of triple-lined area on dial. Airplane should bank 30°, as indicated by artificial horizon. If it doesn't, remove cap from aileron trimmer and adjust trimmer until a 30° bank is attained. Then, if turn is not coordinated (inclinometer ball not centered), adjust rudder trimmer to center the ball. Make

final adjustments with both trimmers and replace caps. Stop turn control at zero, resuming straight and level flight; then re-center. **The turn control transfer** is used to transfer control to the remote turn control used by the radar observer. **Never leave the transfer knob at an intermediate position.**

The **dashpot** on the stabilizer regulates the amount of rudder kick applied by the autopilot to correct rapid deviations in the turn axis. If a rudder hunt develops which cannot be eliminated by adjustment of rudder ratio or sensitivity, the dashpot may require adjustment. This is accomplished by loosening the locknut on the dashpot, turning the knurled ring up or down until hunting ceases, then tightening the locknut.

Cold Weather Operation

When temperatures are between -12° and 0°C (10° and 32°F) autopilot units must be run for 30 minutes before engaging. If accurate flight control is desired immediately after takeoff, warm up the autopilot before takeoff by turning on the master switch during the engine run-up—but make sure autopilot is off during takeoff. If warm-up is performed during flight, allow 30 minutes after turning on master switch before engaging. When temperatures are below -12°C (10°F), units must be preheated for one hour before takeoff. Use special heating covers or blankets with heating tubes.

Emergency Use of Autopilot

Remember the role that the autopilot can play in emergencies.

1. If the control cables are damaged or severed between the pilot's compartment and the servo units in the tail, the autopilot can bridge the gap. There have been many instances where the autopilot has been used thus to fly an airplane with damaged controls.

2. If the autopilot has been set up for level flight, it can be used to hold the airplane straight and level while abandoning ship.

FLYING THE PDI MANUALLY

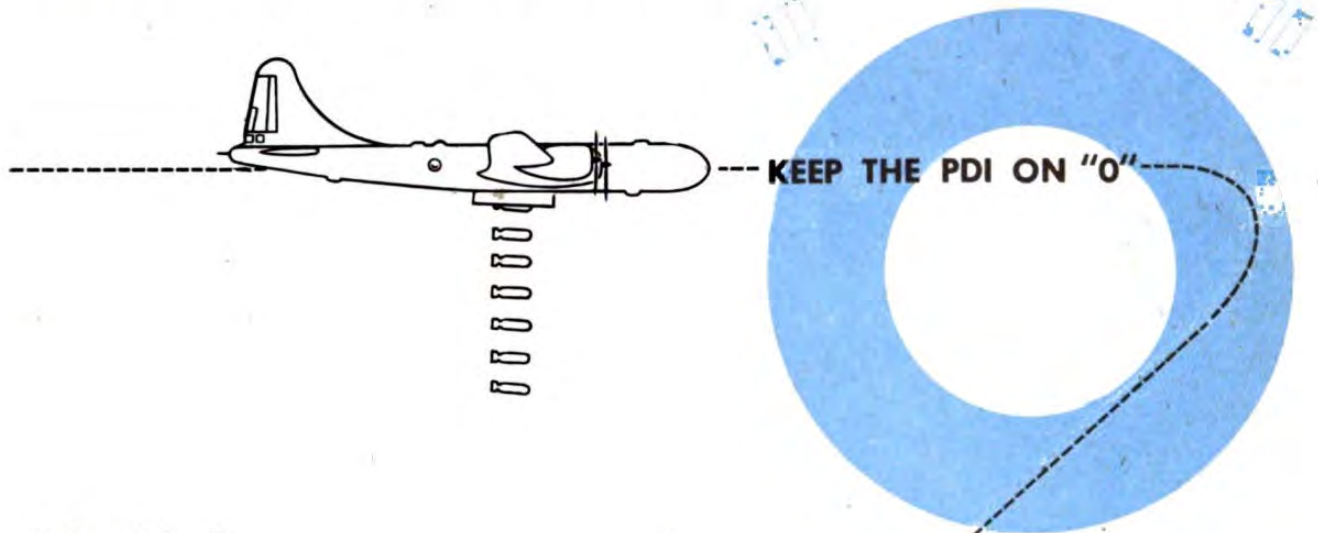

Before Takeoff

1. Check with the bombardier for proper position of the PDI needle for a left turn, right turn, and neutral or 0 position.
2. When bombardier's PDI is left, airplane commander's PDI is right, and vice versa.



On the Bombing Run

Bombing will normally be done while using the autopilot. However, if the autopilot is not functioning the airplane commander may use the PDI.

1. To center the PDI needle, turn the airplane in the direction of the needle.
2. At the beginning of the bombing run, you can usually expect maximum PDI corrections. Do not lead the needle as doing so brings on a tendency to overcorrect.
3. No matter how slight the deviation of the PDI needle from 0, the needle must be returned to 0 immediately.
4. Set turns must be coordinated aileron and rudder turns, in order to make the desired degree of turn more rapidly and to avoid any excessive sliding of the bombsight lateral bubble and induced precession of the gyro.
5. To avoid tumbling of the bombsight gyro, banks must never exceed 18°.
6. Keep PDI on 0 until bombardier calls "Bombs away."

THE FORMATION STICK

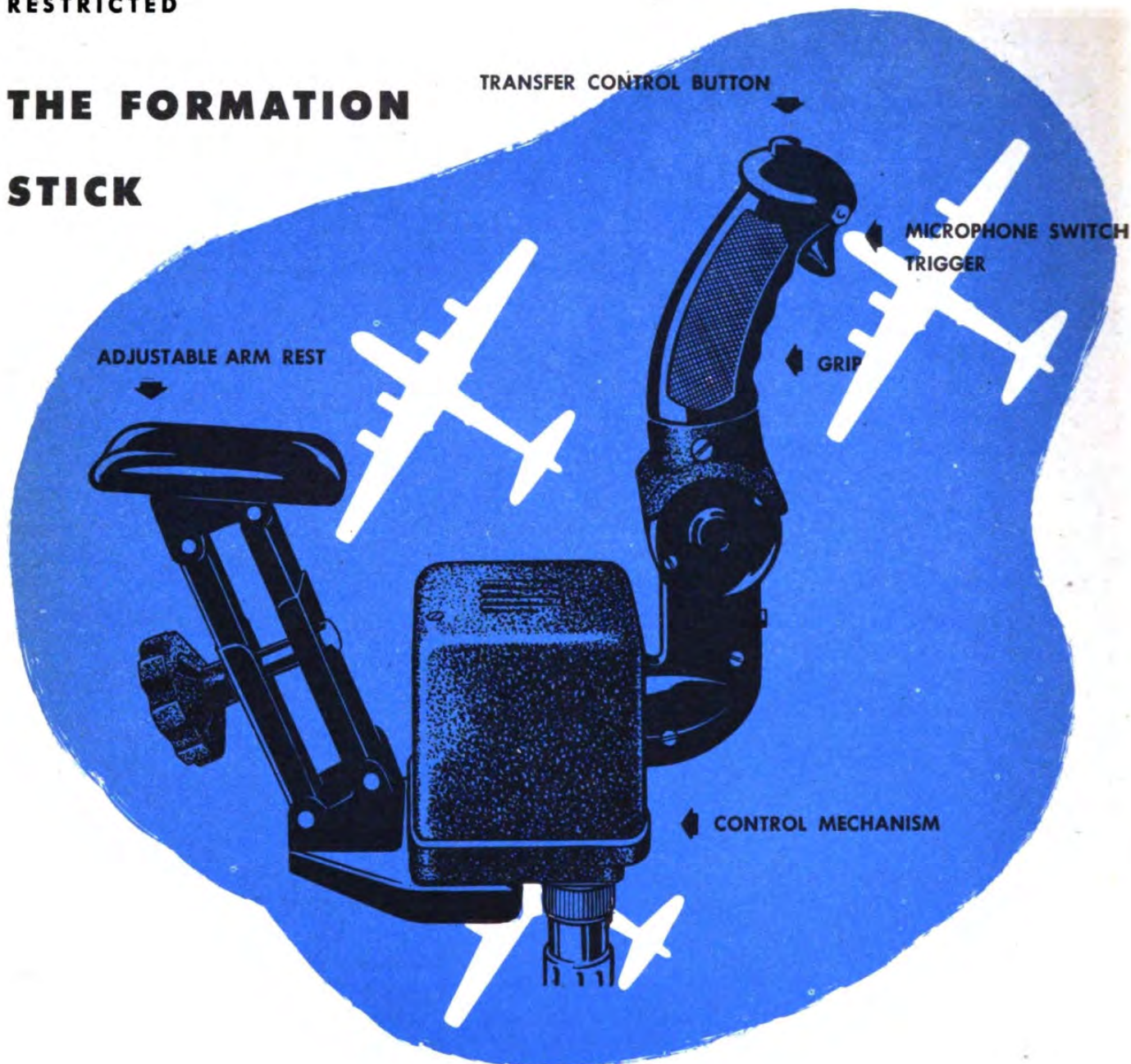

The formation stick is a miniature control stick, working through the autopilot, and enables you and your copilot to maneuver the airplane quickly and with a minimum of effort. You use the formation stick as you would the control stick of a primary trainer—forward and back for descents and climbs, sideways for banks. Sideways movement of the stick controls both ailerons and rudder in coordination, eliminating the need for separate rudder control. Movement of the stick electrically actuates the servo units of the autopilot, which in turn move the control surfaces.

There are two sticks, one on the airplane commander's left, and the other on the copilot's right. Only one stick is engaged at a time; transfer switches place control of the airplane at either the airplane commander's stick or the copilot's. Push-to-talk trigger switches on both formation sticks control the radio microphones.

A four-position function selector determines to what extent the formation stick will control the airplane. The positions of the selector are:

1. OFF—In this position the autopilot operates normally and flies the airplane, the stick having no control.

2. ON SERVO BOOST—The stick is in direct control of the autopilot servos and you must use it as if it were mechanically linked to the surface controls. Use this position when you want quick maneuverability, as in a wing position of a tight formation.

3. ON ELEV. ONLY—The stick provides only vertical control of the airplane, the autopilot controlling ailerons and rudder. The bombardier makes turns with the bombsight autopilot attachment, or the airplane commander can use the autopilot turn control. Use this position when the bombardier has control of the airplane.

4. ON—The autopilot is flying the airplane, with the stick working like the autopilot turn control, except that it provides vertical as well as bank control. Use this position when leading a formation, in a wing position of a loose formation, or in other situations where little maneuvering is required.

How To Use

1. Before takeoff, check both the autopilot master switch and the formation stick function selector in the OFF position.

2. When ready to use the formation stick in flight, set up the autopilot in the normal manner.

3. Engage the formation stick by turning the function selector to ON, ON SERVO BOOST, or ON ELEV. ONLY, depending upon the type of operation desired.

To Transfer Control

To transfer control from the airplane commander's stick to the copilot's stick, push the button on top of the copilot's stick. To regain control, the airplane commander pushes his button. If both buttons are pressed at the same time, the airplane commander gets control. The airplane commander has control automatically when the formation stick is first engaged.

To Disengage Stick

An autopilot release switch on the wheel of each regular control column permits either the airplane commander or the copilot to return the airplane to manual control. Momentary pressure on either switch immediately disengages all three autopilot servos.

To re-engage the formation stick after the release switch has been used, turn off all autopilot switches, retrim the airplane, and then engage autopilot and formation stick in the normal manner.

If the release switch is pressed accidentally and the formation stick has not been moved while the autopilot is disengaged, you can re-engage the formation stick by snapping the autopilot switch off and then right on again, turning the other autopilot switches on without the usual adjustments. Do not use this method unless you are sure the formation stick has not been moved while the autopilot was off.

AIRPLANE COMMANDER'S OPERATING INSTRUCTIONS

Suggested Engaging Procedure For Lead Airplane

1. After takeoff, check that the function selector is in the OFF position.

2. Turn on the tell-tale light shutter switch.

3. Center the turn control knob.

4. Place the turn control transfer knob in PILOT position.

5. Turn on the C-1 master switch.

6. Manually trim the airplane for desired flight attitude.

7. Set all C-1 knobs so that the pointers extend vertically upwards.

8. Turn on PDI and servo switch 10 minutes after turning on master switch.

9. Have the bombardier disengage the autopilot clutch arm to center the PDI and press down on the directional arm lock to keep the PDI centered.

10. Put out the aileron tell-tale lights by adjusting the aileron centering knob.

11. Snap the aileron switch on.

12. Check the gyro-horizon and readjust the aileron centering knob to level the wings.

13. Put out the rudder tell-tale lights by adjusting the rudder centering knob.

14. Snap the rudder switch on.

15. Readjust the rudder centering knob to center the PDI if necessary.
16. Put out the elevator tell-tale lights by adjusting the elevator centering knob.
17. Snap the elevator switch on.
18. Readjust elevator centering if necessary.
19. Turn the function selector to ON. The formation sticks may now be used to make coordinated turns up to approximately 25° of bank and also to control the elevator.

Suggested Engaging Procedure For Wing Airplanes

1. After takeoff, turn the function selector to ON SERVO BOOST.
2. Turn on the tell-tale light shutter switch.
3. Center the turn control knob.
4. Place the turn control transfer knob in PILOT position.
5. Have bombardier disengage the autopilot clutch, move the clutch arm to center the PDI, and press down on the directional arm lock to keep the PDI centered.
6. Turn on the C-1 master switch (this will lock the directional arm).
7. Have the bombardier re-engage the autopilot clutch and release the directional arm lock.
8. Manually trim the airplane for desired flight attitude.
9. Set all C-1 control knobs so that the pointers extend straight up.
Note: All controls must be previously adjusted in flight by competent personnel for best performance under expected conditions and this adjustment indexed by fixing the pointers in the vertical position.
10. Turn on the PDI and servo switch, not less than one minute after the master switch has been engaged. **Note:** If the function selector is left in the ON SERVO BOOST position, it is not necessary to wait 10 minutes for the gyros to erect.
11. Put out the aileron tell-tale lights by adjusting the aileron centering knob.
12. Snap on the aileron switch.
13. Use the formation stick to maintain aileron control as soon as the aileron switch is snapped on.
14. Put out the rudder tell-tale lights by ad-

justing the rudder centering knob.

15. Snap on the rudder switch.
16. Use the formation stick for both aileron and rudder control after the rudder switch is snapped on.
17. Put out the elevator tell-tale lights by adjusting the elevator centering knob.
18. Snap on the elevator switch. The formation stick can now be used to control the flight of the airplane in all axes.

The function selector knob may be turned to any one of the four positions: ON SERVO BOOST, OFF, ON, or ON ELEV. ONLY to give the desired control.

ON SERVO BOOST Position

This position of the function selector is to be used when flying a wing position in a tight formation or whenever quick maneuvering is desired.

To maneuver the airplane, move the stick in the same manner as a conventional control stick would be moved.

The three centering knobs may be used to trim the airplane for the desired attitude with the stick in the normal center position.

Do not adjust the turn control trimmers during ON SERVO BOOST operation.

Aileron and rudder ratio may be adjusted to coordinate the controls for going into a bank or coming out of one but will have no effect while the controls are streamlined in the bank. Therefore, some slipping will be noticed in steep continuous banks.

Do not attempt to adjust the dashpot during ON SERVO BOOST operation since the dashpot has no effect on the operation of the autopilot with the directional arm lock engaged.

ON Position

Use this function selector position when leading a formation, in a wing position of a loose formation, or when very little maneuvering is required. In the ON position the stick is handled in the following manner:

1. For straight and level flight, leave the stick in center, and the autopilot will automatically maintain straight and level flight.
2. To climb or glide, move the stick backward or forward a distance sufficient to produce

the desired change in attitude, and hold it there until ready to return to level flight. Release the stick or return it to center to return the airplane to level flight.

3. For a turn, move the stick from center in the desired direction a distance sufficient to produce the desired bank and turn. Maximum bank obtainable is approximately 25°. Hold the stick in that position until the turn is complete. Return the stick to center to come out of the turn.

Streamlining of controls and application of up-elevator in the turn are automatically accomplished by the vertical flight gyro of the autopilot. More or less elevator may be applied by moving the stick forward or backward. Coordination of turns may be adjusted with the turn control trimmers.

Sensitivity and ratio adjustments may be made for flight conditions. If there is a tendency of the airplane to hunt in the turn axis, the dashpot may require adjusting.

Centering adjustments of the aileron, rudder, and elevator centering knobs may be used to adjust the attitude of the airplane. Make adjustments only with the stick centered.

ON ELEV. ONLY Position

Use this position when the bombardier has control. Hold the stick back to climb, forward to dive. The rate of climb or dive will be governed by the distance the stick is moved from the center. Movement of the stick to right or left will have no effect. Turns may be made by the directional panel (bombardier) or the autopilot turn control.

Changing Position of Function Selector

Always hold the airplane level while changing the selector from one position to another.

Make sure that the PDI is on 0 before changing from any position to ON SERVO BOOST. This is necessary to insure that the erecting cut-out switch in the directional panel is not closed when the directional arm is locked.

The autopilot master switch must have been on for at least 10 minutes before the function selector is moved from the ON SERVO BOOST position in order to give the autopilot gyros time to erect. If banks have exceeded 40° the

autopilot gyros may have tumbled and the function selector should not be moved from ON SERVO BOOST position for at least 10 minutes after the last steep bank.

Tips On Using Formation Stick

1. Make sure PDI is on 0 before turning function selector to ON SERVO BOOST position. Otherwise an abrupt turn may result.

2. Remember that with the selector in ON SERVO BOOST position the autopilot has no control. Use the formation stick as if it were a manual control.

3. Don't use the autopilot turn control when the selector is in ON SERVO BOOST position.

4. Don't exceed 40° banks; the autopilot gyro may tumble. A tumbled gyro will not affect the flying characteristics while the selector is in ON SERVO BOOST position, but if the function selector is moved to any other position a sudden maneuver will result. If you do exceed a 40° bank fly the airplane straight and level for about 10 minutes to allow the gyro to right itself before turning the function selector from ON SERVO BOOST position.

5. Don't use the formation stick as a handhold or hatrack. You can break it.

6. Don't use the formation stick for landing unless your manual controls fail. The stick doesn't provide separate aileron and rudder control, and provides less movement of control surfaces than manual operation.

7. Since the formation stick works through the autopilot, remember to observe the same precautions when using it as you do when using the autopilot alone.

8. Don't expect the formation stick to work properly unless the autopilot is functioning as it should. Use the autopilot ground checklist prior to flight.

Airplane Commander's Ground Checklist For the C-1 Autopilot

1. Center turn control.
2. Turn on C-1 master switch bar.
3. Set control transfer knob at PILOT.
4. Set tell-tale shutter switch ON.
5. Set formation stick function selector at OFF.
6. Set all adjustment knobs to pointers-up

RESTRICTED

position, making sure pointers are not loose.

7. Tell bombardier to center PDI.
8. Turn on servo PDI switch.
9. Operate controls through extreme range several times, observing that tell-tale lights flicker and go out as streamline position is reached from either direction.
10. Turn on aileron, rudder, and elevator switches.
11. Turn aileron centering knob clockwise, then counter-clockwise, observing that wheel turns to the right and then to the left.
12. Repeat Item 11 for rudder and elevator, observing action.
13. Set ratio at maximum and sensitivity at maximum. There should be no control chatter on any axis.
14. Return ratio and sensitivity knobs to pointers-up positions.
15. Have bombardier move directional arm for full right turn, then to left, observing to see if aileron and rudder move in proper direction.
16. Have bombardier center PDI and engage secondary clutch.
17. Rotate turn control knob for right and left turns, observing aileron and rudder controls for proper movement.
18. If all checks are satisfactory, turn the C-1 master switch bar OFF.

Airplane Commander's Ground Checklist For Formation Stick

1. Complete the autopilot ground check, with the exception of the last step, leaving the autopilot engaged.
2. Set the formation stick function selector at ON.
3. Move airplane commander's stick to the extreme right. The control wheel should turn clockwise, and the right rudder pedal should move forward. Make same check to the left.

With the stick held off center, have the directional arm lock on the directional stabilizer checked, to make sure that the arm is held securely. Then release the stick and see that it returns to center automatically, returning control wheel and rudder pedals to center as it moves.

With the formation stick in center, make sure

the directional arm lock is released.

4. Move the formation stick forward, then back. The control column should follow the stick movement, and when stick is released both stick and control column should return to center automatically.

5. Press transfer button on top of copilot's stick, to give his stick control. Then repeat the above check. Transfer control back to airplane commander's stick.

6. Move the function selector to ON SERVO BOOST. Then move the stick to each side and forward and back, making sure that all controls move in the proper directions. The control response should be the same as with the function selector at ON, except that the aileron and rudder controls may not move as far.

7. Move function selector to ON ELEV. ONLY. Then move airplane commander's stick backward and forward to check operation of elevator control. The control column should move only about one-third as far as it does with the function selector in the ON position. Movement of the stick sideways should not affect the ailerons or rudders.

8. Press the transfer button on the copilot's stick and move the stick to make sure that this stick now has control.

9. Press the autopilot release switch on the copilot's control wheel and check operations of controls to make sure they operate freely and autopilot is disengaged.

10. Snap the autopilot master switch off, then immediately back on, and re-engage the remaining autopilot switches.

11. Move airplane commander's stick to make sure it has regained control.

12. Press autopilot release switch on pilot's control wheel and check operation of controls to make sure they operate freely and autopilot is disengaged.

13. Check operation of airplane commander's and copilot's microphone switches. To check, turn radio control switch to INTER-COM position. Then squeeze trigger on each formation stick, while using microphone and listening on headset.

14. Move function selector to OFF, and turn off autopilot master switch.

PNEUMATIC BOMB DOOR SYSTEM

The pneumatic bomb bay door system provides snap action bomb bay door opening and quick door closing. Opening time is .5 to 1 second and closing time 1.5 to 3 seconds.

There are two bomb door safety shut-off valves, one on the panel above the forward bomb door compressor unit and the other on the panel above the right side catwalk in the rear bomb bay.

The bomb door operating system is composed of two interconnected but separately operating systems. Each system has a compressor, accumulator, and actuators for one set of doors. If one of the compressors should fail, a hand operated interconnect valve mounted on the panel above the forward bomb bay compressor unit can be opened and the other compressor will then supply air for both accumulators.

Air supplied by the two compressors is stored in the accumulators. The compressor builds up an accumulator pressure of 1500 psi in approximately 30 minutes at sea level. If the compressors are not started before the airplane has gained altitude, the time required to build up pressure will be greatly increased. When building up pressure from 0 in the aft accumulator, be sure the forward left hand door is closed. This is necessary to remove tension on the aft door release cable which is connected from the forward left hand door to the aft door 4-way valve so that this valve will be in the neutral position. If the valve is not in the neutral position the air will escape through it to the latch actuator and there be lost, thus making it difficult to build up pressure.

When accumulator pressure reaches 1500 psi, the regulating switch opens and the compressor motor stops. A pressure relief valve set for 1750 psi is located on the accumulator. When

the pressure in the accumulator drops to 625 psi, the pressure warning switch turns on a warning light on the bombardier's panel.

OXYGEN

Oxygen on the B-29 is supplied by 18 type G-1, low-pressure, shatterproof oxygen cylinders. All cylinders are filled through one filler valve. The filler valve is located on the outside of the fuselage just forward of the wing on the left side.

Each of the 14 oxygen stations is supplied from two distinct distribution lines. Loss of one line or its associated cylinders still leaves each station with an alternate source of oxygen. The entire system is equalized by the use of cross-feeds controlled by automatic check valves. In the event of partial destruction of the system, all stations still functioning have equal access to the remaining oxygen supply.

Each oxygen station consists of the following equipment: either demand or pressure regulator, pressure gage, flow indicator, low-pressure supply cylinders, and filler and distribution manifolding.

The length of time that the oxygen supply will last varies with the individual requirements of the crew, their activity, the temperature, and the equipment. However, with 400 to 425 psi of pressure and the auto-mix ON, there is more than 10 hours' supply of oxygen for a crew of 11 men flying at 15,000 feet. The system is least economical at altitudes between 20,000 and 30,000 feet. Portable oxygen bottles are provided which may be refilled from the main oxygen system. A-4 bottles last approximately 4 to 8 minutes; D-2 bottles approximately 40 minutes, depending upon the activity of the user and the altitude. These bottles are not equipped with automatic mix features and give only pure oxygen upon demand.

When a crew member is suffering from oxygen lack, open the emergency valve on his regulator, but leave valve open only as long as necessary, as it will empty the system quickly. Leave auto-mix ON at all times to conserve the oxygen supply.



40,000 FEET

CABIN ALTITUDE 12,000 FEET



30,000 FEET

CABIN ALTITUDE 8000 FEET

CABIN PRESSURIZATION AND AIR CONDITIONING



8000 FEET

PRESSURE DIFFERENTIAL OF 1" Hg.

Compressed air for supercharging the fuselage compartments is supplied by the inboard turbos of the inboard engines. The duct take-off is located between the turbo compressor and the intercooler. Compressed air is directed through this cabin air duct, through the aftercooler, and into the cabin through the cabin air valve.

When the cabin air conditioning system is used, the aftercooler flap is closed to provide heat, opened to provide cooling. With the aftercooler flap closed, hot air from around the exhaust shroud is directed through the aftercooler

to heat the cabin air. With the aftercooler flap open, cool air is directed through the aftercooler, overcoming the heat of compression and reducing temperature of air entering cabin.

Air is released from the cabin by two automatic regulators in the rear pressurized compartment, which maintain the following cabin pressures:

0 to 8000 feet.—Pressure differential of 1" Hg.

8000 to 30,000 feet.—Cabin altitude 8000 feet.

30,000 to 40,000 feet.—Constant differential 13.34" Hg. Cabin altitude increases from 8000 to 12,000 feet.

Equipment Check

1. Emergency cabin pressure relief valve on the right side of bulkhead 834—CLOSED.
2. Check vacuum relief valve on the left side of bulkhead 834 for freedom of movement. Normally it hangs vertically, the CLOSED position.
3. Cabin pressure regulators, one on each side of station 646, unlocked. To unlock unscrew the knurled knob on top so that it springs upward.
4. Move the cabin airflow levers at the engineer's panel throughout their entire range to insure freedom of movement and then return them to the OFF position.
5. Operate the engineer's cabin pressure relief valve, located under the seat, throughout its range and then return it to the CLOSED position.
6. Move both cabin air conditioning switches to the COOL position. Have a ground crewman check to see that the aftercooler shutters open fully. When shutters are fully open move switch to the HEAT position and have them checked to see that the shutters close completely.

Starting, Taxiing and Takeoff

1. Cabin airflow valves—CLOSED.
2. Engineer's cabin pressure relief valve—CLOSED.
3. Cabin pressure regulators—unlocked.
4. Aftercooler shutters—CLOSED. To check, move air conditioning switches to HEAT for about 20 to 30 seconds.
5. Cabin pressure warning switch—ON.
6. Open at least one pressure door.

In Flight**Unpressurized with no forced ventilation:**

1. Cabin airflow valves—CLOSED.
2. Engineer's cabin pressure relief valve—CLOSED.
3. Cabin pressure regulators—**unlocked at all times in flight.**
4. Aftercooler shutters CLOSED. To check, move air conditioning switches to HEAT position for approximately 20 to 30 seconds.

Unpressurized with forced ventilation and heating:

1. Open bulkhead door at aft end of radar compartment. Close other bulkhead doors.
2. Open engineer's pressure relief valve.
3. **Keep cabin pressure regulators unlocked at all times in flight.**
4. Open cabin airflow valves to HIGH FLOW position.
5. Increase turbo selector to give desired airflow. **Caution: Manifold pressures will have to be maintained with throttles.**
6. Operate the cabin heating switches to obtain desired cabin temperature.

Pressurizing the cabin:

1. Caution crew members that the airplane compartments are to be pressurized. Caution blister gunners to put on parachutes and fasten safety belts.
2. Have crew members check to see that all compartment doors, windows, emergency release valve and flare chute are closed, cabin pressure regulators unlocked and turret cover domes are installed.
3. Open engineer's cabin pressure relief valve.
4. Open cabin airflow valves.
5. Check airflow. Approximately 7 to 10 indications should give full pressurization. If airflow is too low, increase turbo boost setting. **Caution: Retard throttles to maintain correct manifold pressures.**
6. Gradually close engineer's emergency relief valve until fully closed. For maximum crew comfort a rate of descent of 1000 to 2000 feet per minute should be controlled until cabin is fully pressurized.
7. Check to see that the cabin pressure warning switch is ON.

Note: When pressurized, the oil and fuel pressure instruments read low. To obtain correct instrument pressure readings, convert the cabin pressure differential reading into psi and add to the instrument reading (2" Hg differential pressure—approximately 1 psi).

8. Additional operating tips:
 - a. Doors and windows often seal better if pressed lightly into place.
 - b. In a climb to high altitude start the pressurization prior to reaching 8000 feet, so that the cabin pressure regulators automatically

start operating at approximately 8000 feet and no excessive change in cabin pressure is experienced up to approximately 30,000 feet.

c. Above 33,000 feet put the cabin airflow valves in the LOW FLOW position.

d. Often at high altitude and low cruising powers sufficient cabin airflow may not be available to pressurize the cabin fully. To increase the airflow, increase the power setting of the inboard engines. Decrease the power setting of the outboard engines to maintain desired airspeed. If you want maximum range do not increase power on inboard engines above maximum allowable for auto lean operation.

e. Partial pressurization of cabin. Often in enemy territory you may want only to partially pressurize the cabin in order to minimize the danger of sudden depressurization. To do this, open the engineer's pressure relief valve until cabin pressure decreases to the desired differential pressure. If below 33,000 feet pressure altitude, leave the cabin airflow valves in the HIGH FLOW position in order to provide sufficient airflow for heating and defrosting cabin.

Caution: Manifold pressure changes should be made gradually. Rapid throttle movement will interrupt cabin airflow, resulting in abrupt change in cabin altitude.

Before Landing and After Landing

1. Close cabin air valves.
2. Close aftercooler doors.
3. Turn off cabin pressure warning switch.

Emergency Instructions

1. In case of engine fire or loss of an inboard engine, completely isolate the engine by closing the appropriate cabin air valve.

a. In case of a cabin fire in flight when the cabin is pressurized, notify crew members, obtain acknowledgement, then depressurize immediately, using the emergency relief handle.

b. **Caution: Always notify and obtain acknowledgement from all crew members before**

depressurizing cabin.

c. In the event that a cabin pressure regulator fails in flight, you can lock it down, allowing the other regulator to maintain proper differential pressure. If both fail the engineer's pressure relief valve may be used.

Always depressurize when the airplane is on fire or when preparing to abandon it.

Trouble Shooting

1. If pressurization is inadequate, and airflow is sufficient (usually 7 to 10 indications), trouble is usually cabin leakage or faulty pressure regulators. Check leaks as follows:

- a. Engineer's pressure relief valve CLOSED.
- b. Emergency cabin release valve CLOSED.
- c. Vacuum relief valve CLOSED.
- d. All windows and doors closed.
- e. Turret domes and tail gunners' armor plate seals properly installed and not leaking.
- f. Battle damage, flak or bullet holes patched with flak suits or clothing.

g. To check cabin pressure regulators, lock one down at a time to locate faulty regulator. If neither of them operates properly, open engineer's pressure relief valve, lock both regulators down, and maintain pressure differential with engineer's pressure relief valve.

2. If there is no cabin airflow, check as follows:

- a. Cabin air valve selector handles OPEN.
- b. Increase TBS setting.
- c. Increase inboard engine power settings.

3. If pressurization isn't satisfactory, and the turbo system is functioning properly for engines, trouble must be one of the following situations:

a. Cabin air valves inoperative. Most malfunctions have been failure of these valves to close properly. Opening of the valve is pretty well assured.

b. Leak in cabin airflow system between engines and tunnel. (Can't be repaired in flight.) Isolate the system.

c. Fire or smoke valve closed. (Can't be repaired in flight.)

VACUUM SYSTEM

Vacuum is maintained by the use of two vacuum pumps, one on each inboard engine. Selection of these pumps is made by a cable controlled selector valve, with the control lever mounted on the enineer's stand.



Normal vacuum should read 3.8" to 4.2" Hg and is regulated by:

1. Relief valve (set at 6") in the engine nacelle.
2. Two Schwien regulators (under navigator's chart case).

The air intake is at the airplane commander's instrument panel, and the air filter should be cleaned in accordance with the appropriate technical order.

Vacuum is supplied to camera shutters at 2" Hg, and is regulated by a needle valve restrictor.

Troubles most usually experienced with the vacuum system arise from sheared vacuum pump shafts and broken selector valves. The latter can be substantially offset by slow movement of the selector handle when shifting from one pump to the other. Few regulator malfunctions or clogged filters have been experienced.

RESTRICTED

Trouble shooting procedure is as follows:

1. If one vacuum pump fails, move the selector slowly to the other pump. If vacuum is developed it means that the system from the selector valve throughout the cabin is OK. Since use of the vacuum operated flight instruments is required by the airplane commander, it is recommended that no further check be made in flight, provided one system functions properly.

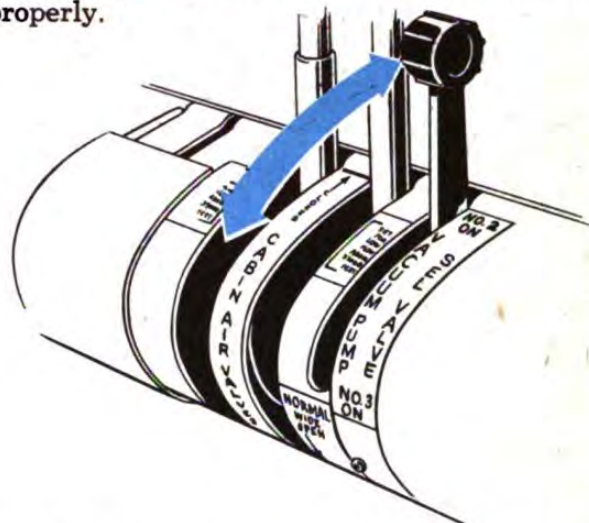

2. Two inoperative vacuum pumps normally indicate failure of system within the fuselage of the airplane. To locate trouble, act as follows:

- a. Move selector handle to determine by feel if the selector valve is being operated.

- b. Close the emergency shut-off valve to deicers and cameras to isolate any trouble within this part of the vacuum system.

- c. If the system is still inoperative, disconnect the vacuum line leading to the flight instruments (at the top of vacuum regulator) to determine if vacuum is present at this point. If OK, trouble is probably a leak in the instrument system. To find the leak, blow cigarette smoke into the instrument vacuum line, having another crew member stop flow from the air filter. Smoke escaping will indicate the leak.

- d. If no vacuum is present at the instrument vacuum line connected to the top vacuum regulator, check the vacuum line leading from vacuum regulators to the vacuum selector valve at the center wing section.

- e. Vacuum instruments can be operated at any altitude by creating 3" to 4" cabin differential pressure.

ELECTRICAL SYSTEM

Electrical power is supplied by six engine-driven, 28-volt, 300-ampere generators (two on each outboard, one on each inboard engine), a 24-volt, 34-ampere hour battery, a 28-volt, 200-ampere auxiliary generator, and two 750 volt-ampere inverters. Engine-driven generators (switches on engineer's control stand) will cut in at 1100 rpm and reach maximum output at 1375 rpm.

The external power plug is located in the nosewheel well or aft of the right rear bomb bay door.

Power from the engine-driven generators is directed to the emergency bus by the landing gear transfer switch (airplane commander's control stand). Power from the putt-putt and battery is directed to the emergency bus by the bus selector switch (battery solenoid shield).

When using bus selector switch, putt-putt should be on the line. (This emergency electrical system is deleted with manual gear.)

The emergency bus, when energized, supplies power only to the emergency landing gear motors and the portable electric motor for flaps and bomb bay doors. Airplanes with manual emergency landing gear do not have the emergency bus or system.

The 24-volt, DC system operates four fuel boost pumps, two anti-icer pumps (one for inboards, another for outboards), four feathering pumps, and two fuel transfer pumps.

The B-29 has the conventional system of position lights, recognition lights, and formation lights. Also included are landing lights which turn on when extended from the underside of the wing. Landing lights should not be extended above 180 mph indicated. Wheel well spotlights, controlled from the engineer's stand, illuminate the landing gear for a visual check at night.

Generators are of sturdy construction and seldom burn out. Voltage regulation, when ad-

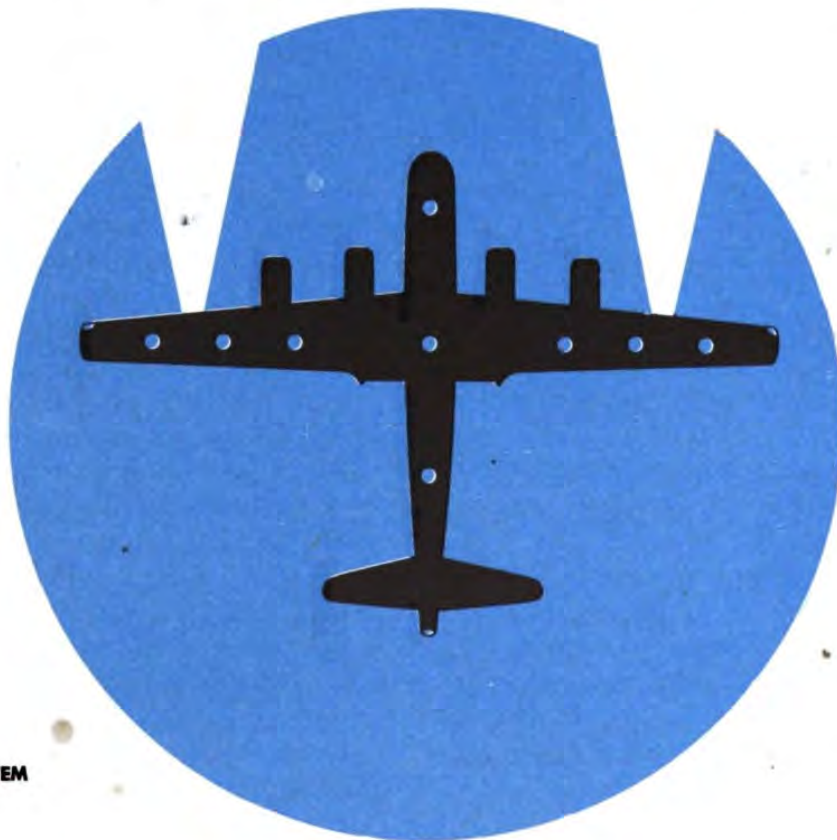

EXTERIOR LIGHTING SYSTEM

justed properly, is dependable. **Once the regulators are adjusted don't tinker with them.** Occasionally relay points will weld together but not often. Proper paralleling of generators at high loads and correct voltage will normally assure good performance.

Parallel the generators by the following procedure:

1. See that the putt-putt is running, with generator and equalizer switches OFF.

2. Adjust voltage regulators one at a time to give 28 volts. When adjusting a regulator, the generator switch for that regulator must be OFF. Use a precision voltmeter if one is available.

Caution: If a regulator is found that will not properly regulate voltage, remove that regulator and write it up in Form IA. **Never** attempt to regulate voltage by changing setting of carbon pile adjusting screw.

3. Turn generator switches ON.

4. Turn three or four gun amplitudynes ON to pull a load of 90 to 150 amps.

5. Parallel the system using ammeter readings. Adjust voltage regulator to bring low amperages up until the difference between any two generators is 10% (or less) of the total load.

6. Re-check voltage for 28 to 28½ volts at bus.

7. Turn putt-putt, generator, and equalizer switches ON.

Parallel the putt-putt with one engine-driven generator and check total load on the line. When properly paralleled and with putt-putt on the line, the engine generator should be carrying approximately one-half the total load.

Caution: Paralleling should be done only by a specialist equipped with a precision voltmeter. Don't tinker with the generator system if it's properly paralleled.

Auxiliary Power Plant

The auxiliary power plant or putt-putt uses Grade 100 fuel and SAE No. 30 oil. As this auxiliary generator is not supercharged, its voltage output will decrease above 10,000 feet. At very high altitudes, the auxiliary power plant will run only if the mixture is leaned out.

Starting the Putt-putt

1. Check bus selector switch on battery solenoid shield at NORMAL.

2. Equalizer switch OFF.

3. Putt-putt control lever to IDLE. (If outside air temperature is zero degrees or less, place lever in CHOKE.

Note: Some auxiliary power plants do not have a control lever; control is automatic.

4. Ignition switch ON.

5. Hold generator switch at START position until the engine begins to run, then place to OFF.

6. Run the putt-putt about 3 minutes, or until the cylinder baffles feel warm to the hand.

7. If the putt-putt has a control lever, move it to RUN.

8. Generator switch to RUN (or ON) position.

9. Equalizer switch ON. Oil pressure limits are 45 to 75 psi.

Stopping the Putt-putt

1. Generator switch OFF.

2. Turn the control lever to IDLE and permit the engine to run 2 or 3 minutes.

3. Equalizer switch OFF.

4. Ignition switch OFF.

Auxiliary Power Plant Control at Engineer's Panel

To provide means of stopping the auxiliary power plant from the engineer's station, a control circuit consisting of switches at the engineer's panel and at the auxiliary power plant, indicator lights, wiring, and a normally closed relay in the magneto ground circuit have been installed. When the magneto ground circuit is opened by energizing this relay or by other means, the magneto is "hot," and the power plant will run. The indicator lights in the control circuit, which are located on the engineer's panel and auxiliary power plant relay shield, indicate when this relay is energized and the magneto grounding circuit thereby opened.

On the power plant itself is a switch labeled IGNITION. This switch is between the magneto and the relay in the ground circuit and is

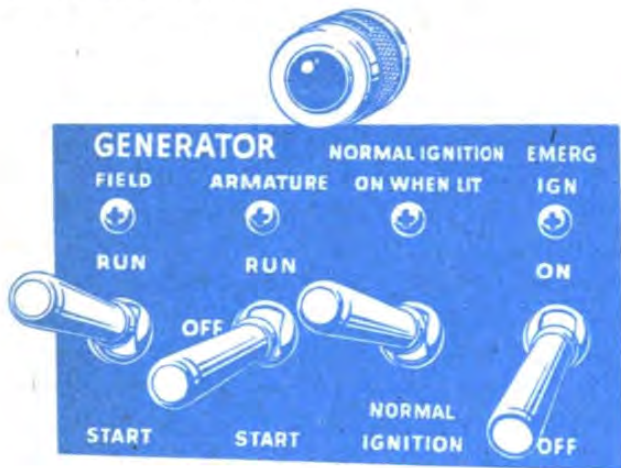

CONTROL PANEL

lock-wired in the OFF position at modification centers to keep the grounding circuit closed.

Note: When there is no electric power available on the airplane, the auxiliary power plant magneto grounding circuit cannot be opened electrically. Under these conditions, the circuit can be opened by cutting the lock wire and moving the switch to the ON position. The power plant can then be started manually. Normally, however, the grounding circuit will be opened or closed to run or stop the putt-putt respectively by operating the relay from either the switch on the auxiliary power plant control box, or the switch on the engineer's panel. Operation of the control circuit for starting the putt-putt is as follows:

ELECTRICAL EQUIPMENT FAILURE:

Dead Circuits

1. First check the generators and inverters to make sure the system is not going dead. For example, interphone going dead or fluorescent lights going out may be the first indication that the generator switches are OFF or that the putt-putt is not on the line.

2. Then check the fuses, or the circuit breaker re-set buttons. For examples given above, check the OFF-ON switch on the interphone amplifier, the interphone fuse in the radio compass relay shield forward of the radio operator and the interior lighting fuse in the engineer's forward fuse panel.

1. Flip the ignition switch to turn on the indicator lights. This indicates that the magneto ground circuit is broken, making the magneto operative. The switch positions cannot be marked ON and OFF because they are dependent on the position of the switch on the engineer's panel.

2. Depress the generator and starter switches to the START position. When the engine fires, release the switches.

WARNING: Observe the oil pressure indicator. If oil pressure is not indicated within 30 seconds, shut off the putt-putt.

3. If oil pressure is indicated, adjust the choke as required until the engine is thoroughly warmed up. Then place lever in the RUN position.

For manual starting, the procedure is the same as above, except that the generator and starter switches are left OFF.

When stopping the auxiliary power plant from the engineer's station, throw the switch to de-energize the normally closed relay in the magneto grounding circuit (indicator light goes out). The equalizer switch at the power plant can be turned off by another crew member at the earliest opportunity. If a crew member is available at the auxiliary power plant to turn it off, it would be advisable to turn the generator switch OFF and idle the engine for about 2 or 3 minutes to cool it gradually, then turn ignition switch OFF.

Fuel transfer pumps, propeller governor circuits, propeller feathering control circuit (late series), bombardier's bomb door control circuits (late series), inverters, and gun turret amplidyne are equipped with circuit breaker re-set switches.

Excessive Voltage

Excessive voltage is caused by failure of a voltage regulator to operate accurately. Mechanical failure, an overspeeding or runaway prop, or an "open" in the electrical ground of the regulator might be the cause of this condition.

The first indication is smoking and fire in

electrical equipment in various parts of the plane. The flight engineer should immediately:

1. Place battery switch and all generator switches to the OFF position and stop the putt-putt (if it is running).
2. Check all generators for excessive voltage and amperage.
3. Remove voltage regulator of malfunctioning generator.
4. Apply cabin fire procedure if necessary.
5. Place generator switches and battery switch ON (and start the putt-putt if needed), watching closely for recurrence of trouble.

Note: Flight engineer checks the voltmeter for excessive voltage to locate the bad generator. He checks amperage, because with the generators OFF, an ammeter reading indicates a fused relay. In the case of excessive voltage along with a fused relay, prompt action is required, because only by removing the voltage regulator can the electrical trouble be eliminated.

AC Electrical System

Alternating current at 26 and 115 volts and 400 cycles is supplied by two or three (depending on the airplane series) inverters for the operation of supercharger controls, radar, radio, flux gate compass, etc.

This AC power is very important, as failure will result in turbo control failure (inadequate or excessive manifold pressures) and loss of radio contact.

If the inverter which normally supplies power to the AC equipment fails, an automatic switch will cut in the alternate inverter. Indicator lights on the airplane commander's and engineer's panels show which inverter is operating—or if both of them have failed. The automatic switch may be over-ridden by a manual switch at the engineer's station. Use this switch if the automatic change-over system is inoperative.

Airplanes incorporating a large amount of radar equipment utilize a third inverter for this purpose. No spare is provided for the radar inverter.

High Inverter Voltage

High AC voltage is generally caused by high

DC voltage input to the inverter, rather than by maladjustment of the inverter governor. This condition can be remedied by re-parallel-ing the generators to obtain 28 to 28½ volts at the bus.

With no electrical load the AC upper voltage limits should not exceed 30 and 128 volts. With a full electrical load (TBS, flux gate compass, and radio compass on) the lower voltage limits should not be less than 25 and 103 volts.

Inverter Changeover Relay

Incorporated within the change-over relay are an AC relay, a DC relay, and a heater switch consisting of a bi-metallic actuating arm and heater coil. Placing the inverter switch in the NORMAL position energizes the heater coil. Within 2 to 8 seconds, the movement of the bi-metallic arm completes the circuit to the DC relay. Closure of the DC relay does not affect the operation of the normal inverter if its output voltage has become sufficient to close the AC relay (30 to 85 volts). However, the DC relay completes a circuit whereby the alternate inverter will be cut in immediately if the AC relay has not been closed or if the AC relay opens at a later time as the result of normal inverter failure. Closure of the DC relay also de-energizes the heater coil, but approximately one minute is required for the bi-metallic arm to cool and break contact.

If, upon starting, the normal inverter output voltage fails to build up within approximately 8 seconds, the change-over relay will automatically cut in the alternate inverter. Similar action takes place if the normal output voltage falls to a point between 30 and 70 volts.

If the normal inverter is turned off momentarily after it has been operating, movement of the inverter switch back to the NORMAL position within 90 seconds will probably cause the alternate inverter to operate. This is because the heater switch contact is still closed. Further, the alternate inverter will run indefinitely under these conditions; but in the event of its failure the normal inverter will not cut in. This causes all advantages of the change-over relay to be lost in addition to imposing unintended wear on the alternate inverter.

Emergency System

When the emergency pressure falls below 900 psi, the amber warning light on the flight engineer's panel goes on. To service the system, switch the emergency system filler valve on the flight engineer's panel to OPEN and press the pressure over-ride switch on the engineer's stand until the pressure builds up to between 1000 and 1075 psi. The pressure over-ride switch operates the pump regardless of pressure in either the normal or emergency system. The pressure relief valve opens at 1075 psi and reaches its full open position at 1200 psi.

Trouble Shooting

Checking operation of hydraulic system prior to landing is strongly advised. The most frequent failures in the hydraulic system have been leaks caused by battle damage or vibration. Only a few hydraulic pump motor failures have been encountered.

If the pump is inoperative in AUTOMATIC, check MANUAL. If neither will operate, check the manual pump control fuse located in engineer's forward fuse panel and the automatic pump control fuse located in engineer's aft fuse panel.

Continuous operation of the hydraulic pump indicates a hydraulic leak, malfunctioning pressure switch, or a stuck relay. To locate trouble, proceed as follows:

1. Ask the airplane commander if he is applying the brakes.
2. Remove the automatic control fuse from engineer's aft fuse panel (pump should stop).
3. Note normal system pressure. Loss of pressure indicates a leak. Attempt to locate and repair same. If there is no pressure loss, the continuous pump operation is caused by a faulty pressure switch.
4. If a leak cannot be found, bleed the normal accumulator to prevent loss of fluid. Recharge system manually for landing.
5. Failure of hydraulic pump to stop after fuse is removed indicates a stuck relay. To stop pump remove the cannon plug to hydraulic pump motor or cut the main pump power lead (P-178) near urinal at station 218. Prepare the cut wire to be quickly spliced before landing.

Little trouble has been experienced with the emergency hydraulic system. If a leak occurs in this system and cannot be located, bleed the system and don't recharge it until ready for landing.

FUEL SYSTEM

Fuel is supplied from two inboard and two outboard self-sealing wing tanks, bomb bay tanks, and in some airplanes, center wing section tanks. Each inboard wing tank has a capacity of 1435 gallons; outboard wing tanks each hold 1340 gallons. Two to four bomb bay tanks holding 640 gallons each may be incorporated to increase the fuel supply, and the wing center section tank holds 1315 gallons (1100 in the B-29A). Each engine receives its fuel supply from a system separate from those of the other three engines, thereby eliminating possible failure of all four engines because of a single fuel line failure.

Fuel pressure is maintained by conventional engine-driven fuel pumps. If one of these fails, the electrically driven fuel booster pumps at the outlet of each fuel tank can be used as they will supply pressure up to 18 psi. You must use the fuel booster pumps on take-offs and landings as an added safety precaution against engine failure resulting from mechanical trouble developing in the engine-driven pumps. Boost pumps must also be used at high altitude to eliminate excessive vapor in the lines.

Under normal operation, if an engine-driven fuel pump fails and you use the fuel booster pump to supply pressure, watch the fuel pressure indicator carefully. Should the fuel pressure drop below 15 psi or rise above 18 psi, turn off the turbo-supercharger control and remove the amplifier controlling that engine before using the turbos again. This is necessary because the fuel pressure is no longer being balanced against carburetor deck pressure by the pressure valve on the engine-driven pump. Fuel pressures outside the usual operating range may result in a lean mixture with subsequent engine damage. This problem is critical

RESTRICTED

It should be noted that when the inverter switch is in the ALTERNATE position, the change-over relay is bypassed.

Note

Check inverters as directed in the **Flight Engineer's Checklist**. Also note that the change-over relay does not relieve the engineer of the necessity of checking the AC voltmeter frequently. Output voltage of the normal inverter may drop as low as 30 volts before the alternate inverter is cut in, whereas the electronic turbo control system will not function if the AC voltage drops below 95 volts—100 to 120 volts is considered its satisfactory operating range. If voltage other than 100 to 120 is encountered, the switch should be moved to the ALTERNATE position without further delay.

Inverter Trouble Shooting

Troubles encountered with the inverter system are usually high voltage, low voltage, or no voltage at all, caused by relays being stuck open.

1. High or low voltage indicates a high or low DC bus voltage. Check it and adjust if necessary.

2. If only part of the inverter-operated equipment is malfunctioning, switch to alternate inverter to check both output voltages.

3. Both inverters inoperative indicates a stuck relay or popped-out circuit breakers. Reset the circuit breakers. If inverters still do not run, operate the relay manually. A malfunctioning switch may necessitate binding the relay contact points closed or bypassing the switch. The former is somewhat easier to accomplish.

4. After high inverter voltage has been encountered and remedied, check operation of the flux gate compass and turbo control systems to ascertain that no fuses have been blown.

HYDRAULIC SYSTEM

NORMAL AND EMERGENCY

Normal System

A hydraulic panel is located under the floor of the forward compartment, near station 218, and contains an electrically driven pump, pressure accumulator, filter, pressure switch, relief valve, shut-off valve and check valve. Quick disconnects allow the panel to be removed without draining the system. Accumulator pressure, however, must be bled before removing the panel.

Pressure is controlled automatically by a pressure switch which cuts in at 800 psi and out at 1000 psi. As a safeguard against broken lines, it will prevent pump from running if pressure is below 200 psi. Pressure may be controlled manually by holding the engineer's over-ride switch until the desired pressure is reached. This switch is spring-loaded to the automatic position.

Metering valves mounted at the rudder pedals are for metering fluid under pressure to the deboost valves. The deboost valves are mounted in the inboard nacelles, above the oleo struts, and meter fluid to the expander tubes at one-fourth the original pressure with correspondingly increased volume. This prevents brake lag and also expedites the return of fluid to the reservoir.

Capacity of the hydraulic tank is 4.9 gallons. The tank gage should read approximately 2 gallons when the parking brakes are set and both accumulators are charged to 1000 psi. The air pressure preload in both is 400 psi.

To check accumulator preload pressure, remove the 2-amp hydraulic pump fuse in engineer's aft fuse panel and bleed the system by depressing the brake pedals. Preload is the pressure indicated the instant before gage falls to zero.

RESTRICTED

only when operating at altitudes greater than 8000 feet.

Fuel System Trouble Shooting

Fuel Boost Pump: Very little trouble has been experienced with fuel boost pumps. They are designed for long-period continuous operation and are usually reliable. If failure occurs, however, check as follows:

1. Check high boost operation. If okay, low boost field lead is open.
2. If high boost is also inoperative, check the 20-amp fuse in engineer's aft fuse panel. Replace if necessary.
3. Ordinarily, failure of the fuel boost pump is not critical, therefore, unless the engine-driven pump fails, it is recommended that no further repair be attempted in flight.
4. Only in emergency should the switch be bypassed to obtain pump operation.

Fuel Shut-Off Valve: Most failures of this unit are experienced on the ground, since it is seldom operated in flight. If malfunction occurs, check the 15-amp fuse in engineer's forward fuse panel.

Main Line Fuel Strainer: Proper daily inspection of strainers will prevent malfunction. If the fuel strainer becomes clogged low fuel pressure will result. Turn on high boost to maintain sufficient fuel pressure or, if necessary, reduce engine power setting.

Fuel Pump: Failure of a fuel pump is indicated by loss of fuel pressure. Turn on high boost and continue the mission, provided a

close check does not reveal a fuel leak. Observe the previously discussed precautions on flying at altitude with a failed engine-driven pump.

Fuel Leaks: Fuel leaks are definitely dangerous. The scanners are your best insurance for locating fuel leaks. Keep them aware of the importance of engine observations.

FUEL TRANSFER SYSTEM

Fuel is transferred by two reversible electric pumps controlled through toggle switches and circuit breakers on the engineer's control stand. Hourly capacity at sea level, with both pumps operating, is 1500 gallons per hour; at 30,000 feet it is 500 gallons per hour. The system may be operated with either of the two pumps, in which case transfer capacities are 900 gallons at sea level and 300 gallons at 30,000 feet.

Note: Fuel transfer circuit breaker switches must be left ON at all times. This prevents excessive chipping and pitting of the breaker points.

Fuel may be transferred between rear bomb bay tanks and front bomb bay tanks; between rear bomb bay tanks and tank 3 or 4; between front bomb bay tanks and 1 or 2, and across the airplane from engines 1 or 2 to either 3 or 4. Fuel may be transferred between wing center section tank and any other tank, as each tank selector quadrant has a position marked "wing center section tank."



FUEL BOOSTER PUMP SWITCHES

WARNING

Whenever fuel fumes are detected, airplane commander will be notified on CALL position of interphone.

Airplane commander immediately orders entire crew on oxygen (walk-around bottles, if necessary) and orders search for source of fumes.

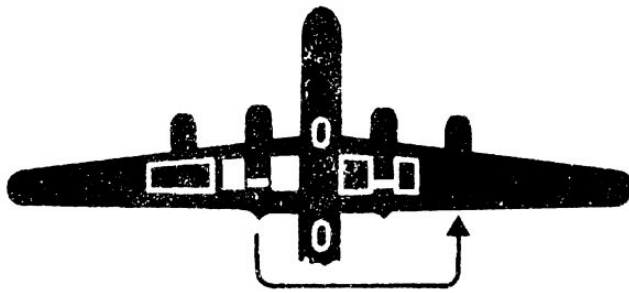

DESIRED TRANSFER—NO. 2 TANK TO ENG. NO. 4 TANK

DESIRED TRANSFER—NO. 4 TANK TO ENG. NO. 1 TANK

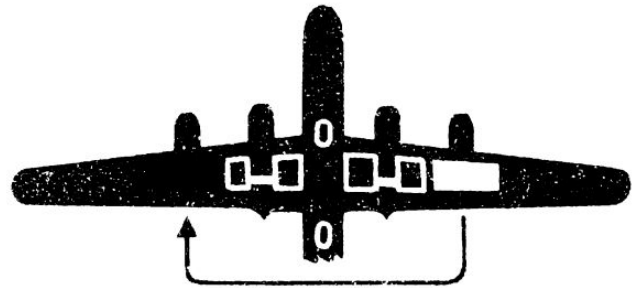

DESIRED TRANSFER—FWD. BOMB BAY TANK TO NO. 4 TANK

- A, From Forward Bomb Bay Tanks to Aft Bomb Bay
- B, From Aft Bomb Bay Tank to Eng. No. 4 Tank

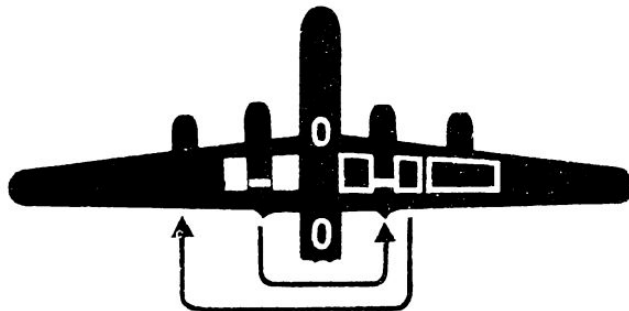

DESIRED TRANSFER—NO. 2 TANK TO NO. 1 TANK

- A, From Eng. No. 2 Tank to Eng. No. 3 Tank
- B, From Eng. No. 3 Tank to Eng. No. 1 Tank

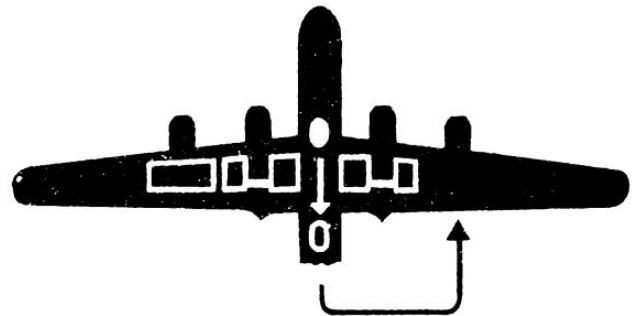

There are several different installations of bomb bay fuel shut-off valves and check valves. The engineer must know the location, operation, and function of the valves in order to transfer fuel efficiently and safely.

The fuel transfer flow indicator light will be ON only when fuel is flowing from one tank to another.

Fuel Transfer Procedure

On all tactical missions where fuel is carried in center wing section or bomb bay tanks, start transfer of fuel within two hours after takeoff. All fuel should be transferred into wing tanks by the time you're within 100 miles of target.

Should the fuel transfer system fail, make no attempt to continue on the mission unless there is sufficient usable fuel in the wing tanks to complete the mission, with a reserve of 500 gallons of usable fuel when landing at the nearest emergency landing field.

Operational Precautions: Careful observance of the following precautions aids considerably in effecting fuel transfer with a minimum of

mechanical or electrical failures in the system.

1. Transfer fuel at the lowest altitude possible. As you increase altitude the tendency of fuel to vaporize increases. This situation encourages vapor lock, pump cavitation and resulting excessive hydraulic shock loads on the fuel transfer pump.

2. Keep fuel transfer circuit breakers ON at all times unless an overload forces the switch to OFF position. Keeping the switch in the ON position prevents overload between the breaker and the motor.

3. Adjust tank selector handles carefully to the detent position. Don't move selector handles to another tank with fuel transfer pumps operating.

4. Turn on one fuel transfer switch at a time. Check for proper operation of pumps by increase of ammeter load or by steady glow of fuel transfer lights.

5. Keep an accurate record of quantity of fuel transferred to and from each tank.

6. Place tank selector handles in OFF position when not transferring fuel.

RESTRICTED

7. Be careful to balance fuel quantities in main wing tanks.

8. **Allow no one to smoke while fuel is being transferred.**

9. Turn off radar equipment while fuel is being transferred.

10. **Caution: Wait 30 seconds before reversing the direction of fuel transfer.** Sudden reversal of the fuel transfer motor may cause an excessive hydraulic shock with subsequent or immediate failure of the pump vanes.

11. If the flight engineer suspects that the fuel transfer pumps have operated on an empty tank he must report it on the Form 1A.

12. A good precaution to use before transferring fuel is to prepare the airplane for immediate pressurization. Then if necessary you can quickly clear the cabin of dangerous fuel vapors which might enter from bomb bay areas.

Fuel Transfer Trouble Shooting

In the event of failure of the fuel transfer system proceed as follows:

1. Check circuit breakers and electrical power supply.

2. Check position of the tank selector handles by depressing the fuel transfer lights with transfer switches OFF. If handles are incorrectly set, transfer lights will not light and relay will not click. Move the tank selector handles in the vicinity of the detent position until the relay clicks and the transfer lights will operate when depressed.

3. If a click is heard it is reasonable to assume that the trouble is located in the power circuit of the fuel transfer system. If relay does not operate, trouble is in the control system. In an emergency, lift the panel and close the relay manually.

4. When failure of the power circuit is encountered, operation of a fuel transfer pump can be obtained by the following method:

a. Short one field lead (small wire) to ground.

b. Connect the armature lead (large wire) and the other field lead to the power supply in the forward bomb bay door solenoid shield.

c. The direction of fuel flow can easily be determined by fuel transfer lights. Trial and error method will have to be used for airplanes not having transfer lights installed.

d. To reverse direction of pump operation, simply interchange the field wires.

5. Occasionally broken pieces of pump vanes have prevented movement of the selector handles. Should this happen when transferring from the center wing section, clamp the fuel line leading from the selected wing tank to prevent gravity transfer into the center wing tank.

CAUTION: It is possible to transfer fuel to two fuel tanks simultaneously if a poppet in a selector valve is stuck open.

6. Broken fuel transfer cable controls can be operated by hand. Open catwalk in the front bomb bay as near the center wing section as possible to obtain access to cables. It's a good idea for the flight engineer to mark the tank selector cable positions prior to flight.

7. To transfer fuel from the bomb bay or center wing tanks **in emergency**, the following system has been used:

a. Bypass one pump.

b. Place the tank selector handles as desired.

c. Disconnect the vent line.

d. Place nozzle of a CO₂ fire extinguisher over the vent line.

e. Discharge bottle intermittently and slowly to force fuel from the tank.

8. To transfer fuel from outboard to inboard tank on same side, this system can be used:

a. Clamp both inlet lines leading from the wing fuel tanks to the bomb bay area.

b. Remove the lines from the selector valve and insert a piece of tubing, thereby completing connection between the tanks.

c. Release the clamps and allow transfer to proceed by gravity.

MANIFOLD FUEL SYSTEM

Description

The manifold fuel system installed in late B-29's comprises a single manifold fuel line connecting the engine supply, wing tanks, and the auxiliary tank or bomb bay tanks, through which fuel can flow from any tank to any engine. The manifold system eliminates the transfer system, transfer pumps, tank selector valves, connecting tubing and controls. Submerged booster pumps are installed at the auxiliary center wing tank and bomb bay tanks, connected through shut-off valves to the manifold fuel line. Shut-off valves are also installed in each main tank line and in each engine line and between the manifold line and each main tank-engine combination. Check valves in the main wing tank, auxiliary wing tank, and bomb bay tank lines prevent reverse flow of fuel from the manifold line back into the tanks.

Three-position toggle switches on the engineer's panel control the booster pumps. The positions are NORMAL PRESSURE, EMERGENCY PRESSURE, and OFF. The electric fuel shut-off valves may be either solenoid-operated or motor-operated, either type requiring electric power to close or open. The shut-off valve control switches on the engineer's panel are 2-position switches for the motor-operated valves and 3-position momentary contact switches for the solenoid-operated valves. Push-type circuit breakers at the engineer's station protect the shut-off valves and booster pumps.

Operation

1. **Starting.** Open engine fuel valves and main tank valves. Operate main tank booster pumps, but not auxiliary or bomb bay tank booster pumps.

2. **Takeoff.** Operate main tank booster pumps in normal position, with engine fuel valves and main tank valves open. Keep auxiliary or bomb bay tank valves, manifold fuel valves, and

booster pumps OFF.

3. **To use auxiliary tank fuel.** Start auxiliary tank booster pump and open auxiliary tank and manifold fuel shut-off valves. Shut off fuel booster pumps at the main tanks, making certain that the engine fuel valves remain ON. When 60 gallons of fuel remain in the auxiliary tank, turn on booster pumps for three of the engines, leaving one engine to be supplied directly from the auxiliary tank. When the auxiliary tank is empty, start the booster pump for the remaining engine and shut off the auxiliary and manifold fuel valves. Check the fuel quantity gages for the auxiliary tank, since the engine which consumed the remainder of fuel in the auxiliary tank will continue to operate after the auxiliary tank is empty, because the three booster pumps in the main tank system supply this fourth engine through the manifold system.

If bomb bay tanks are installed, use fuel from them in the same manner. However, use fuel from the bomb bay tanks first, starting with the lower tank.

4. **To use fuel from tanks other than the respective engine tank.** In case of engine failure shut off the dead engine fuel valve. Pump the fuel from the dead-engine tank through the manifold system by operating the booster pump of the stopped engine and shutting off the booster pump for the engine or engines which are to receive this fuel. When the dead-engine tank is dry, shut off the booster pump and main tank valve. Close all manifold fuel valves, making sure that the booster pumps and main tank valves for the other engines are ON.

Precautions

1. Keep all engine fuel valves and main tank valves open for takeoff and normal flight.

2. Keep all manifold fuel valves closed except when using fuel from auxiliary and bomb bay tanks or running an engine or engines on the fuel from the dead engine's tank.

3. Use fuel from auxiliary fuel tanks as soon after takeoff as you reach a safe altitude.

4. Allow nobody to operate this equipment who has not been given complete instructions in its use.

OIL SYSTEM

The engine lubrication system serves the primary function of lubricating and cooling the engine and also supplies the necessary oil to operate the propeller governor. Some airplanes receive oil for propeller feathering from the engine oil system, but it is expected that these will soon be changed to the independent feathering system.

Each engine receives its oil supply from an 80-gallon (plus 5-gallon expansion space) self-sealing tank in the nacelle. An oil cooler in the oil outlet between the oil tank and the engine controls oil temperature. The shutters on the oil cooler can be operated automatically by a thermostatic control or manually by the flight engineer. When low ground temperatures are anticipated, oil dilution is accomplished by operating four switches on the engineer's control panel. These switches actuate four solenoid valves which in turn control dilution of the oil with fuel.

OIL DILUTION SWITCHES

Engine Oil Pumps: Engine oil pumps are of sturdy construction and are usually reliable. Failure is normally indicated by a sudden loss of oil pressure. When this occurs, cylinder-head temperatures should be watched carefully to ascertain that the trouble actually is the oil pump and not a leak in the instrument pressure line. If cylinder-head temperature begins to increase, it is reasonable to assume that the engine oil pump has failed. Failure of the nose oil pump will normally be accompanied by a pressure drop and a runaway propeller, two rather definite indications. In either case, **reduce speed and feather the propeller.**

Oil Leaks: In an emergency, the quantity of leaking oil can be reduced by lowering "oil in" temperature to 55°C. When an oil leak has exhausted the supply of oil to approximately 10 or 15 gallons feather the propeller. By doing so you'll be certain of having sufficient oil to complete the feathering process.

TURBO-SUPERCHARGERS

Each engine on the B-29 has two turbo-superchargers which boost the manifold pressure for takeoff and provide increased air pressure at high altitudes. Engine exhaust gas, passing through the collector ring and tailstack to the nozzle box of each supercharger, expands to atmosphere through the turbine nozzle, and drives the bucket wheel at high speed.

A ramming air inlet duct supplies air to the turbo impeller which increases its pressure and also its temperature. In order to avoid detonation, the air is supplied to the carburetor by way of the intercooler, where its temperature is reduced. After entering the engine, the air is further pressurized by the crankshaft-driven internal impeller, resulting in greater power output.

Turbo Control System

Turbo Boost Selector: A Minneapolis-Honeywell Electronic Turbo Regulator System is used for control of boost and is regulated by a master control located on the airplane commander's aisle stand. It contains one master potentiometer and four small calibrator potentiometers which require adjustment only to compensate for small differences in engine or turbo performances. Once the system is calibrated, the airplane commander can control turbo boost on all four engines simultaneously by operating the master potentiometer.

Pressuretrol: The Pressuretrol is the sensing element which measures electrically the pressure of the air supplied by the turbo to the carburetor. This unit controls the automatic



operation of the system to maintain whatever pressure the airplane commander has selected, regardless of atmospheric pressure changes caused by altitude variation. It is located on the upper left side of the engine nacelle, just above the access plate.

Turbo Governor: The turbo governor is a dual safety device driven by the turbo-supercharger through a flexible shaft. One part of the mechanism is called the overspeed control and prevents the turbo from exceeding its safe operating rpm limit. The other part, the ac-

celerometer, anticipates the pressure increase from turbo acceleration and provides a signal to the amplifier, which opens the waste gate and prevents overshooting of the manifold pressure. This unit is located on the right side of each engine directly in the rear of the turbo drive shaft. One governor is used to control both turbos.

Amplifier: The amplifier is an intermediate unit between the control units and the waste gate motors. It receives a positive or negative signal, according to the changes in manifold pressure and turbo speed, and sends the proper signal to the waste gate motor, opening or closing the waste gates as required. Amplifiers No. 1, No. 2 and Spare are located above the navigator's table. Amplifiers No. 3 and No. 4 are under the navigator's table.

Waste Gate Motor: When this motor operates in response to the amplifier current and control signals, it also operates a balancing potentiometer, producing a signal opposed to the original control signal. When the two signals completely neutralize each other the waste gate motor stops. Therefore, the amount of waste gate operation is controlled by the size or amount of the original signal. One waste gate motor operates the two waste gate through mechanical linkage. It is located directly above and between the turbos.

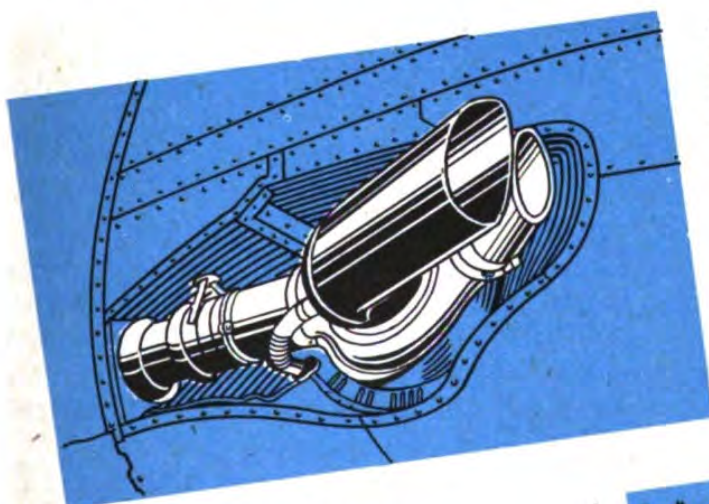

TURBO-SUPERCHARGER

TURBO-SUPERCHARGER WITH FLIGHT HOOD REMOVED

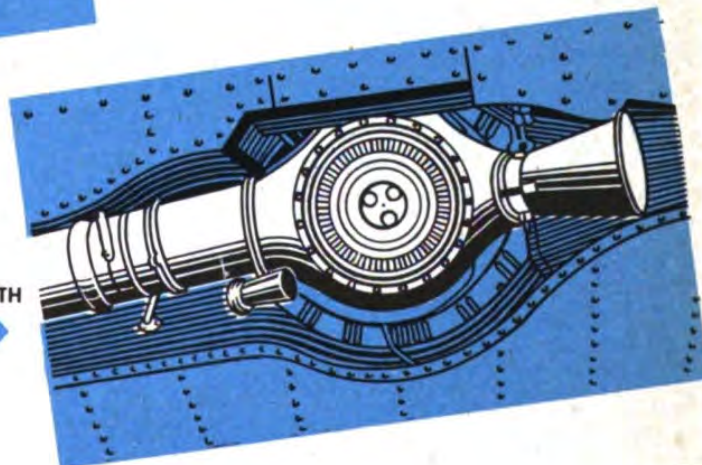

RESTRICTED

Trouble Shooting

In spite of the complexity of the turbo system, its operation is ordinarily not particularly troublesome. The types of possible malfunctions are numerous but in most cases are not hard to locate. Trouble shooting of the system can be performed in flight, and the procedures given below have been found effective.

1. When turbo systems on all engines are inoperative, trouble usually is in the TBS or the inverter. Correct as follows:

- a. Check TBS setting.
- b. Check inverter voltage. If low, check DC voltage. Increase if necessary.
- c. Switch to alternate inverter, if normal inverter is inoperative.
- d. Check turbo system circuit breaker and fuses (5-amp single fuse in older airplanes or individual 5-amp fuses in late airplanes).
- e. It is very unlikely that four amplifiers would fail at one time but, as a last resort, replace one with the spare to check this possibility.

2. No turbo boost on one engine indicates that the trouble is within that particular system. Check as follows:

- a. Feel turbo amplifier to see if it's quite warm. If it is, there is no need to check further as power supply is OK.
- b. Replace amplifier with spare. Check amplifier cannon plug number to see if it corresponds to the engine amplifier number. If still inoperative, remove **right hand** discriminator tube to close the waste gate. Be certain that the airplane commander is ready to retard throttle when waste gate closes. A little additional fuel will be consumed but there need be no fear of overspeeding the turbo unless power and altitude combination is rated and above 30,000 feet.
- c. A cold amplifier indicates trouble in the power system. Check system fuse in inverter relay shield. If OK, install spare amplifier or new fuse in old amplifier.

3. In an emergency, waste gates can be opened or closed by jumping terminals in the J box to the left of the navigator's position, as follows:

- a. A-1 to A-3 for No. 1 engine;
- b. A-2 to A-4 for No. 2 engine;
- c. C-1 to C-3 for No. 3 engine;
- d. C-2 to C-4 for No. 4 engine.

When the jumpers are in place, move the TBS to the desired position. The amplifier can be bypassed to give an opening signal by shorting terminal D to terminal E in the cannon plug.

POWER PLANT TROUBLE SHOOTING

Although malfunction may occur in many parts of the airplane mechanism, trouble with the engines in flight possibly causes more anxiety than anything else.

Continuous watch should be made of all engines. This is particularly important during high-power operation. Any symptoms of engine trouble should be reported to the cockpit immediately in a clear, concise, and preferably calm manner. Symptoms of engine trouble in flight, as applied to the aft compartment observers, may in general be divided into three classes: (1) oil leaks, (2) smoke, and (3) fire. Quite often the three, or two of the three, are interrelated.

Oil Leaks

A fairly wide swath of oil coming back over the top of the wing behind an engine nacelle may be indicative of oil coming from an oil tank filler neck which has been improperly capped by the ground crew. The rate of oil flow in all probability will not be rapid, and there should be no accompanying smoke.

Oil without smoke coming from underneath the wing in any appreciable flow probably indicates an oil cooler core leak. The engine should be shut down if the leak is sufficiently severe.

Any leaks of oil that come from the cowl flap opening will probably be accompanied by puffs of bluish-white smoke and spattering of oil along the nacelle and wing. Generally, these symptoms of trouble indicate: (1) a blown oil line, or an oil line burnt through by an exhaust flame; (2) probability of a cracked cylinder

head pumping oil and smoke out of the cowl flap opening; (3) any other type of failure where oil and heat are involved. Sometimes a rocker box oil leak may be mistaken for severe engine failure. Generally these types of leaks result in mild intermittent puffs of gray smoke coming from under the cowl flaps at one location, probably accompanied by a gradual spreading of oil film behind the cowl flaps along the nacelle. These failures are not serious but should be watched carefully since the same symptoms could be applied to beginnings of other types of failures as mentioned above.

Excessive oil from an engine breather would probably result in the underside of the engine nacelle being spattered with oil. This type of leak might come from a failed scavenger pump or a ring failure. In the latter case smoke will probably accompany the oil from the breather. Oil foaming at altitude should not be mistaken for an engine failure. This condition is evidenced by a voluminous gushing from the engine breather of a fine oil spray, similar in appearance to very light smoke. (See **Emergency: Fire.**)

Manifold Pressure Surge At High Altitude

To eliminate manifold pressure surge at high altitude, advance rpm and MP on outboard engines until a fully opened throttle and related power setting is obtained, or until surge is eliminated. Reduce MP and rpm on inboard engines to balance this condition for best maximum-range airspeed, or until cabin pressurization can just be maintained.

If the manifold pressure surge persists, advance rpm (approximately 50 to 100 rpm) on all affected engines, or until surge is eliminated. Balanced power between opposite sides of the airplane must be maintained.

CAUTION: The above procedure may give unrelated power settings which are undesirable and should be eliminated as soon as possible.

Detonation

Detonation is explosion of the mixture within the cylinder in contrast with the normal controlled burning of the mixture. Detonation exerts excessive pressure against the cylinder walls because all the mixture burns at once,

rather than over a period of time.

Detonation can be identified by high cylinder-head temperatures, rough engine operation, and puffs of black smoke issuing from the exhaust. Detonation is a result of high temperatures and pressures, and it becomes pronounced and destructive as these factors increase. Therefore, detonation can be caused by (1) a climb or maneuver which tends to cut down the cooling air flow and raise head temperatures, (2) increasing carburetor air temperatures in an attempt to avoid icing, (3) high cylinder pressures and temperatures caused by increase in power, (4) closing cowl flaps, or (5) lean fuel-air mixtures increasing combustion temperatures.

Proper correlation between rpm and manifold pressure is also necessary to prevent excessive BMEP which causes detonation. Poor sparkplug operation will cause pre-ignition and detonation at high power settings. Use fuel of correct octane rating to prevent detonation. If detonation should occur, enrich the mixture, lower the manifold pressure, lower the carburetor air temperature, and lower cylinder-head temperatures by opening cowl flaps or increasing airspeed.

Backfiring

Engine backfires occur so frequently that this symptom of trouble is generally understood as being an engine malfunction. A multitude of troubles may cause an engine to backfire but normally corrective maintenance cannot be performed in flight. It is for this reason that trouble-shooting in flight is directed primarily toward reducing the frequency and severity of backfires. Sparks of burning carbon are frequently seen coming from exhaust stacks at low power settings. This is normal and is not a malfunction. Suddenly increasing the rpm setting of an engine from a very low setting to a fairly high setting (as before landing) may result in a few mild backfires. An excessive TBS setting at low powers may cause mild backfiring.

Severe Backfiring: Severe backfiring is normally encountered at relatively high power settings. It can be easily heard or can be felt

RESTRICTED

as a kick on the throttle control. **Severe backfiring can cause an engine fire. Watch the engine closely.** The primary causes of severe engine backfiring, with remedies, are:

1. Faulty carburetion—lean mixture. To correct in flight, place mixture control in AUTO RICH and reduce power if necessary.

2. Improper valve operation. To correct in flight, place mixture control in AUTO RICH and reduce power if necessary.

3. Ignition and timing malfunctions. Place mixture control in AUTO RICH and reduce power setting if necessary.

4. Induction leaks. Reduce manifold pressure to outside atmospheric pressure.

5. Pre-ignition. Decrease cylinder-head temperature. Place mixture control in AUTO RICH if necessary.

6. Low fuel pressure. Increase pressure using high boost. Reduce power if necessary.

Mild Backfiring: Mild backfiring is usually encountered at low power settings. Any of the troubles listed above may cause mild backfiring. A few additional causes and remedies are:

1. Idle mixture set too lean. Place mixture control in AUTO RICH.

2. Excessive carburetor air temperature. Reduce CAT.

3. TBS setting excessive. Reduce setting.

Afterfiring

Afterfiring is an explosion of fuel in the exhaust manifold system. It can be easily distinguished from backfiring since no throttle movement accompanies the explosion. Suddenly retarding the throttle of an engine may cause afterfiring but in most cases this does not indicate a malfunction. The usual causes and remedies of afterfiring are as follows:

1. Burned or sticking exhaust valves. Reduce power setting to stop afterfiring.

2. Rich mixture. Check mixture control for proper placement.

3. Fouled sparkplugs. If cylinder-head temperature is low, increase it to maximum allowable.

4. Improper timing. Try different power settings in an attempt to eliminate afterfiring.

Rough Engine

Often an engine will run rough with no evidence of backfiring or afterfiring. A rough engine can usually be detected by watching the vibration of the front sump in relation to the nacelle nose. Excessive vibration of instrument panels or armor plate may also indicate a rough engine. Try to eliminate the roughness, since if disregarded it may lead to more serious trouble.

The following corrective actions may smooth engine operation:

1. Move mixture control to AUTO RICH.

2. Reduce manifold pressure slightly or change the power setting in an attempt to find conditions that give smooth operation.

3. Reduce cylinder-head temperature. Often a very slight reduction will be enough.

4. Reduce rpm setting if there is any possibility of the propeller being out of track.

OIL COOLER DOORS

The position of the oil cooler doors is normally adjusted automatically by a thermostatic control so that oil temperatures are maintained within desired operating ranges. By moving the 4-position switch on the engineer's panel from AUTOMATIC to OPEN or CLOSE it is possible to over-ride the automatic control and open or close the doors as required. The doors will remain in fixed position when the switch is moved to OFF.

Checking Oil Cooler Door Operation

1. Using an external power source, open the oil cooler doors with the manual over-ride switch. Check each door for full open position (4.5" for inboard engines; 4.3" for outboard engines).

2. Close the oil cooler doors using the manual over-ride switch and check closed position.

3. Open the oil cooler doors fully with the manual over-ride switch, then place switch at AUTOMATIC. Doors should close, provided

the oil temperature is not above 65°C and the automatic system is operative.

Note: No checks of automatic opening of oil cooler doors can be performed readily before starting engines.

Starting, Taxiing and Takeoff

1. Keep the oil cooler control switch in AUTOMATIC unless oil temperatures exceed 95°C. If temperatures exceed this limit, open the doors manually until the temperatures decrease to within normal operating limits.

2. Excessive ground operation often results in high oil temperatures. Idling the engines for a few minutes at 700-800 rpm with the airplane headed into the wind should reduce oil temperatures to within operating limits.

In Flight

1. Leave the oil cooler switches in AUTOMATIC unless oil temperature cannot be controlled automatically within the 65°-85°C range. If temperatures cannot be controlled within this range, oil temperatures should be controlled manually between 70° and 80°C.

2. If power surge is encountered during high altitude operation, operate oil cooler doors manually to maintain oil temperatures at 80°-85°C. This should affect turbo surge favorably.

3. If an oil cooler congeals, causing high oil temperatures, close the oil cooler door manually to allow the cooler to clear. Observe oil temperature closely. A decrease in temperature will be noted as the oil cooler core begins to allow normal oil flow. As soon as the temperature begins to increase again, open the oil cooler door gradually until the temperature drops to normal. Then return the control switch to AUTOMATIC.

4. With wheels and flaps up, oil cooler door position can be observed in flight from the side

gunners' positions. Have these gunners make an operations check and report.

5. If excessive oil leaks are encountered in flight, the quantity of oil lost can be held to a minimum by manually reducing oil temperatures to 55°C.

After Flight

Place the switch in OFF until the engines have cooled, then close the oil cooler doors manually and return switches to OFF.

Trouble Shooting

Troubles developing in the oil cooler door system can generally be traced to sticking relays, dirty contact or wiper points, improperly greased oil cooler door actuating screws, failed motors, or blown fuses. Effective countermeasures can frequently be taken in flight.

If the automatic control system fails, try to control the doors manually, with scanners observing and reporting door operation from the rear of the airplane. If this works, operate the doors through several cycles in an attempt to clean wiper or contact points. Manually control the doors until the oil temperature is approximately 70°-75°C. and then see if the automatic system will take over. If not, use the manual control for the rest of the flight.

Should both the manual and the automatic systems fail to work, check the fuse in the engineer's aft fuse panel and replace if necessary. Do not attempt to bypass the oil cooler switch except in an emergency.

Normally the failure of an oil cooler door to operate occurs when the door is partially open. Therefore, oil temperatures can be maintained within limits by adjusting the power setting.

CAUTION: It may be impossible to feather the prop if the oil temperature is allowed to become excessively high.

EMERGENCY ELECTRICAL SYSTEM

Many of the controls in the B-29 are electrically operated. In view of this, you will need an understanding of the basic electrical system before you can meet all emergencies.

Two electrical systems were installed on the first airplanes—a normal system to provide electrical power to all units under normal conditions, and an emergency system to provide power for the emergency landing gear motors and for the portable emergency motor that operates wing flaps and bomb doors. More recent airplanes are equipped with a manual landing gear system and have only a single electrical system. Check your airplane and if it falls into the first category, remember that the emergency transfer switch on the airplane commander's control stand must be thrown to the emergency position before any power is available to the emergency distribution system. As an alternate the bus selector switch on the

battery solenoid shield may be thrown to emergency but this will power the emergency system only from the battery and the auxiliary power plant, and not from the engine-driven generators. Only by throwing the landing gear transfer switch can the engine-driven generators be put on the emergency system. If both of the above-mentioned switches or the landing gear transfer switch alone are in their emergency positions, the engine-driven generators, the battery, and the auxiliary power plant are supplying power to both systems. Remember this: check your airplane to see whether it has an emergency distribution bus or only the normal system. If it has the emergency distribution bus, it will be necessary to power the emergency system before the landing gear can be operated under emergency conditions or before the portable motor can be used for any of its applications.

TABLE OF AMPERAGE LOADS

ITEM	NORMAL LOAD (amperes)	PEAK BATTLE LOAD (amperes)
Upper forward turret	132.5	275.5
Upper aft turret	132.5	275.5
Lower forward turret	84	84
Lower aft turret	84	84
Tail turret	252	420
Tail ammo booster motors (2)	40	40
C-1 autopilot	6	6
Bomb doors (forward and aft)	480	480
Landing gear (2)	460	
Nose gear	155	
Wheel well doors (2)	280	
Wing flaps	200	
Hydraulic pump	110	
Landing lights	52	
Liaison radio	38	
Radar	100	100

POWER DISTRIBUTING SYSTEMS (SIMPLIFIED)

EARLY AIRPLANES

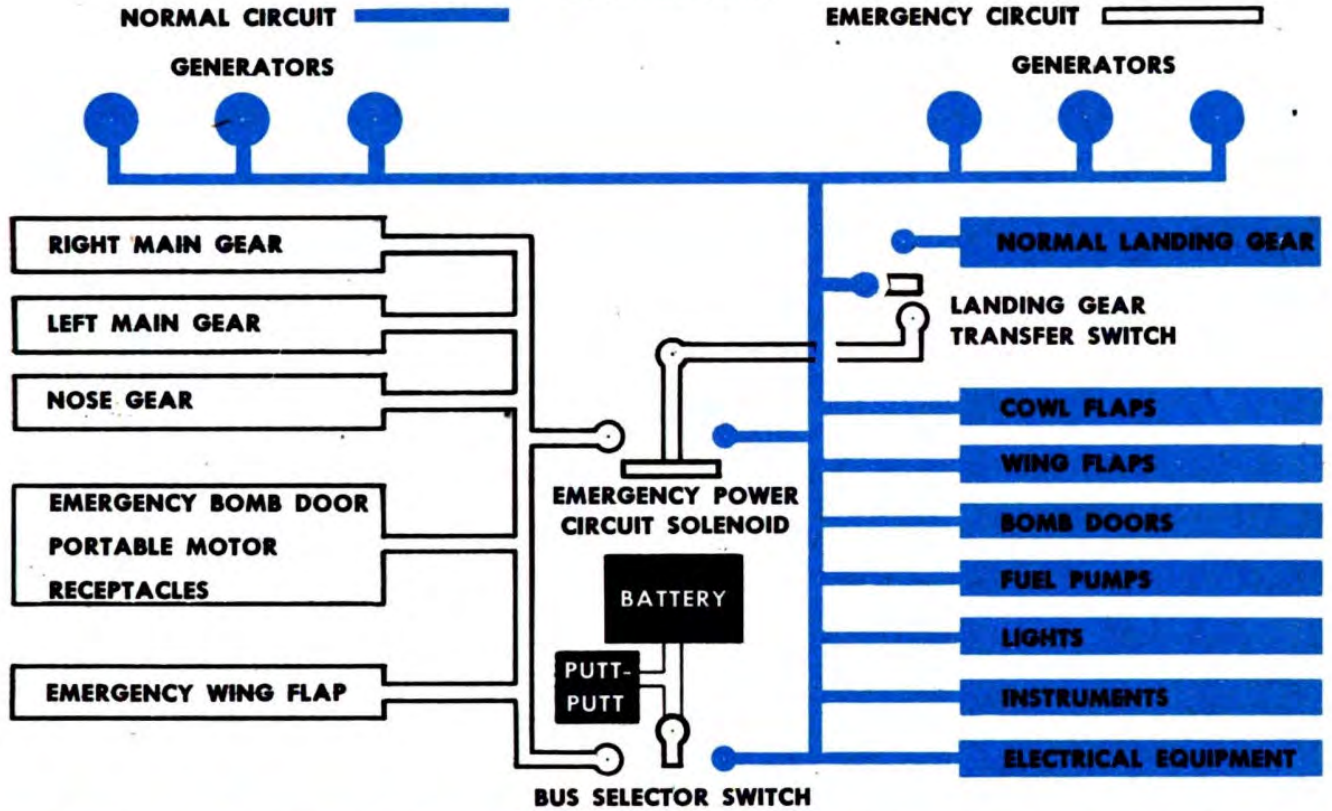

AIRPLANES WITH MANUAL EMERGENCY LANDING GEAR SYSTEMS

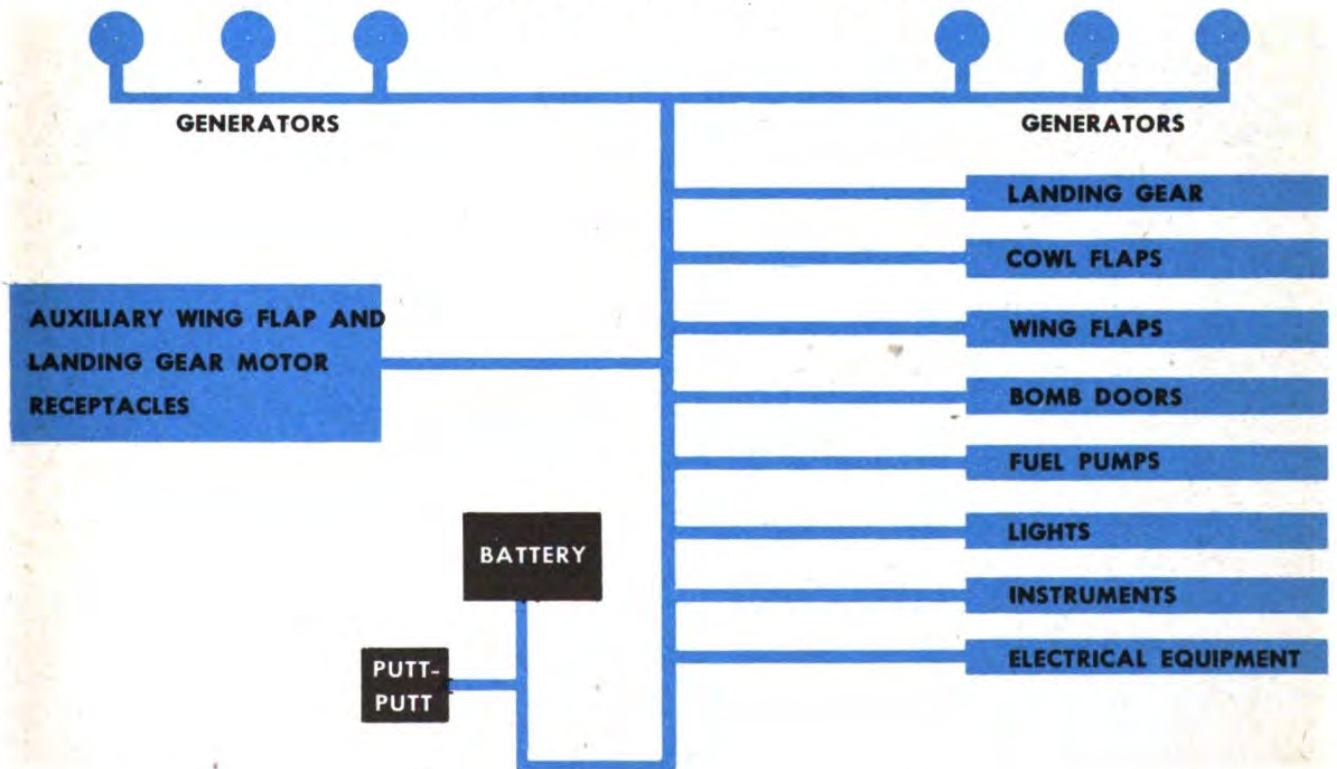

COWL FLAPS

Each nacelle is equipped with 12 cowl flap assemblies, of which 10 are movable. The two uppermost flaps are stationary and are normally held open 2½" by bolts and spacers.

Later series airplanes and field modifications of the earlier series have short-chord cowl flaps to provide improved engine cooling and to decrease drag. The two top flaps have been spring loaded, allowing them to move to the same position as the operable cowl flaps when the latter have been opened more than 2½". The top flaps are held open 2½" by stops when the operable flaps are closed.

The movable cowl flaps are operated by electrically actuated jackscrews controlled by switches located on the flight engineer's panel. Maximum cowl flap opening is 7.28" or 27½°. This maximum opening is used only for controlling cylinder-head temperatures during ground operation. A position warning switch connected to the airplane warning system serves to prevent takeoff and flight with the cowl flaps open more than 15°.

Checking Cowl Flap Operation

1. Open cowl flaps to be certain that all flap segments operate and open to the full 27°.
2. Close cowl flaps to the fully closed position. Check flaps to be certain that all segments close to approximate streamline with the nacelle. Improper setting of jackscrews may result in one or more segments failing to close far enough, or may tend to close too far and twist off the flexible cowl flap drives.
3. Keep cowl flaps closed when engines are not operating and are cooled below 100°C, unless they must be open for maintenance reasons.

Starting and Taxiing

Open the cowl flaps to full open position before starting the engines and leave them open until just prior to the start of the takeoff roll.

Takeoff

1. Just a few seconds before takeoff, begin to close cowl flaps to the 7½° position.
2. Never start a takeoff if cylinder-head temperatures exceed 220°C. Idling engines at 700-800 rpm with the airplane headed into the wind should cool the engines to below 220°C within a few minutes.
3. During takeoff close the cowl flaps gradually as cylinder-head temperatures permit.

In-flight Operation

1. For maximum fuel economy and safety, adjust cowl flaps to maintain cylinder-head temperatures at the maximum specified limits.
2. Make no adjustments of cowl flaps after the final approach has been started, otherwise the airplane commander may be forced to make additional and unexpected trim adjustments.
3. As soon as the landing is assured and when the nosewheel touches the ground, open cowl flaps fully.

Taxiing

Leave cowl flaps fully opened.

After Flight

After engines have been shut down and are cooled below 100°C, close the cowl flaps completely unless they must be kept open for maintenance reasons.

CAUTION: Always allow approximately 3 to 5 seconds before reversing the direction of cowl flap motion.

Trouble Shooting

If the cowl flap system on an engine should fail in flight, check the fuse in the engineer's forward fuse panel. Further action is usually unnecessary for a power reduction or operation in auto rich will normally keep cylinder-head temperatures within operating limits.

RESTRICTED

switch panel.

If these checks do not disclose the trouble the horn circuit is probably shorted. Pull the 10-amp cabin warning fuse in the engineer's forward fuse panel. If horn continues to blow, remove the 5-amp fuse in the airplane commander's aisle stand.

CAUTION: Removing the 10-amp cabin warning fuse breaks circuit to red "unsafe to

land" landing gear warning light and de-energizes the warning horn relay. Removal of the 5-amp fuse in the airplane commander's aisle stand breaks the power supply to the warning horn and to the green "safe to land" landing gear warning lights. If it is necessary to pull this latter fuse to stop the horns, fuse must be replaced momentarily after the gear is lowered, to check and see if green lights are on.

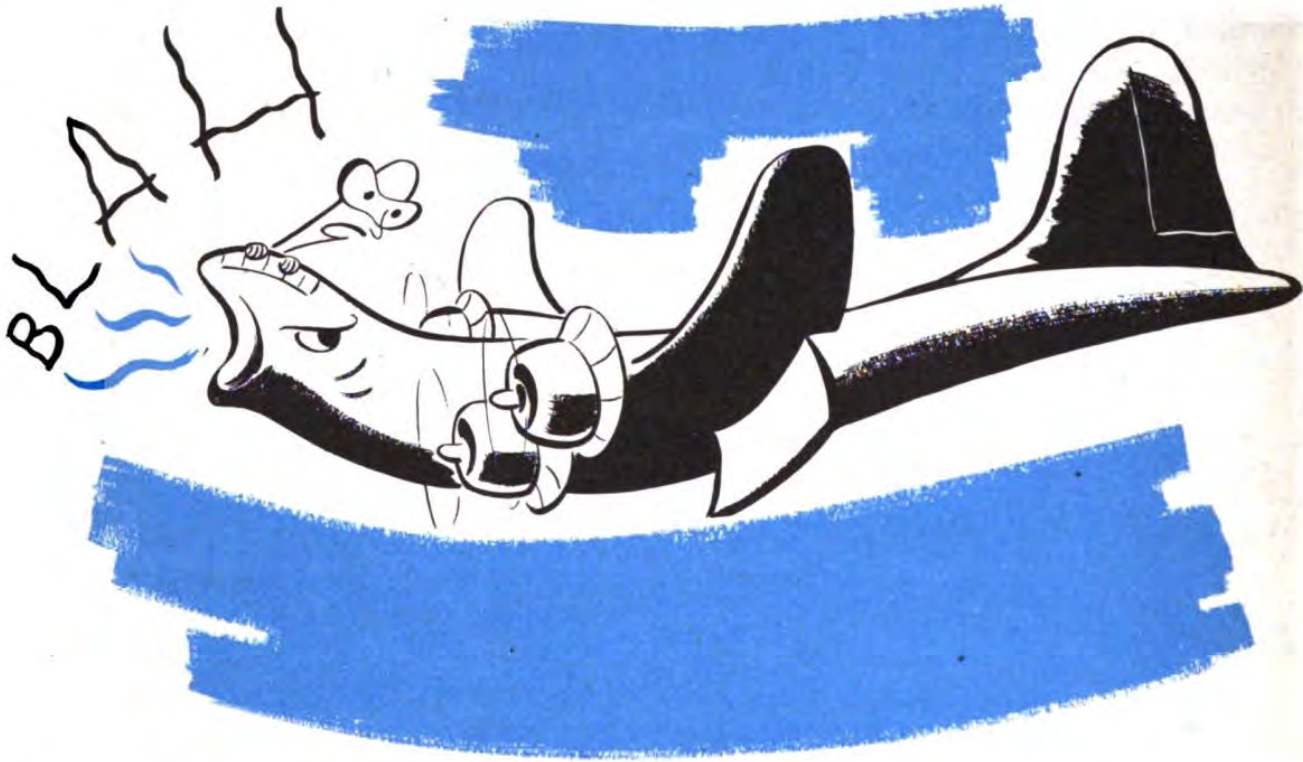

RPM CONTROL TROUBLE SHOOTING

This system has presented a number of operational difficulties. The chief troubles have been:

1. Broken resistor clips or burned out resistors.
2. Electrical motor and clutch failures.
3. Improper rpm settings at high and low limits.
4. Broken or sticking switches.

If the rpm control fails, check as follows:

1. Push re-set button and try the switch again.
2. Jog the switch in an attempt to dislodge

broken clip or move commutator from a dead spot.

3. If propeller electrical head is operating properly as indicated by limit lights, when operated to the high and low rpm positions, the following should be done to aid governor in controlling rpm.

a. Increase oil temperature on engine to 85°C and jockey throttle in an attempt to obtain proper governing action.

b. Reduce rpm with feathering motor in an attempt to aid governor control except on airplanes equipped with separate feathering oil supply.

c. Reduce airspeed.

d. Reduce altitude.

TROUBLE SHOOTING IN FLIGHT

Trouble	Probable Cause	Corrective Action
1. ENGINE OPERATION		
A. ENGINE BACKFIRING AND AFTERFIRING		
Severe (frequent) backfiring	1. Faulty carburetor. (Lean mixture)	1. Check indent position or move to AUTO RICH. Reduce power.
Watch for induction or other fires	2. Improper valve operation.	2. AUTO RICH mixture. Reduce power.
	3. Ignition and timing malfunction.	3. AUTO RICH mixture. Reduce power.
	4. Induction leaks.	4. Reduce manifold pressure to atmospheric pressure. Watch carefully for fire.
	5. Pre-ignition.	5. AUTO RICH mixture. Decrease cylinder head temperature.
	6. Low fuel pressure.	6. Increase pressure.
	Mild (infrequent) backfiring. Normally encountered at low power settings	1. Faulty carburetor.
	2. Turbo boost too high.	2. Reduce TBS setting.
	3. Improper ignition.	3. Auto-rich mixture. Try a different power setting.
	4. Excessive CAT.	4. Reduce CAT.
	5. Low fuel pressure.	5. Increase fuel pressure.
Afterfiring (explosion) of fuel in exhaust manifold	1. Faulty exhaust valves.	1. Reduce power. Watch for fire.
	2. Rich mixture.	2. Check indent position. Try AUTO LEAN.
	3. Fouled spark plugs.	3. Increase the CHT to limit if low.
	4. Improper ignition or timing.	4. Try a different power setting.
	5. Excessive retarding of throttle to low manifold pressure.	5. Maintain correct manifold pressure and rpm relationship during normal flight operation.
B. ROUGH RUNNING ENGINES		
Rough engine	1. Slightly lean mixture, faulty valve operation, improper timing and faulty ignition.	1. Check indent position of mixture control. Try operation in AUTO RICH. Try a power change. Reduce CHT.
	2. Propeller out of track.	2. Check track of propeller. Change power setting.

Trouble	Probable Cause	Corrective Action
C. PROPELLERS		
Inability to change rpm	<ol style="list-style-type: none"> 1. Inoperative electric head. 2. Faulty switch. 3. Faulty governor. 	<ol style="list-style-type: none"> 1. Push reset button. Joggle switch. 2. Joggle switch. 3. Change electric head rpm setting. Increase oil temperature to 85°C and change throttle setting. Reduce rpm with feathering button. Reduce air speed. Reduce altitude.
Runaway propeller (except on takeoff)	<ol style="list-style-type: none"> 1. Internal failure. 2. No nose oil pressure. 3. Low nose oil pressure. 	<ol style="list-style-type: none"> 1. Feather. 2. Feather. 3. Retard throttle. Reduce rpm setting. Reduce airspeed. Reduce altitude.
Inability to feather propeller	<ol style="list-style-type: none"> 1. Burned out feathering motor, lack of feathering oil, leak in feathering line, circuit breaker popped out, excessive oil temperature, or excessive rpm. 	<ol style="list-style-type: none"> 1. Push reset button. Reduce airspeed. Check copper fuse jumper.
D. ENGINE FUEL SYSTEM		
Low fuel pressure	<ol style="list-style-type: none"> 1. Fuel leak. 2. Instrument malfunction. 3. Engine fuel pump failure. 4. Clogged main line strainer. 5. Fuel booster pump inoperative. 	<ol style="list-style-type: none"> 1. If leak is confirmed, shut off fuel, feather propeller, transfer fuel. 2. None. 3. High fuel boost. Reduce power if necessary. 4. High fuel boost. Reduce power if necessary. 5. Try high fuel boost. Check fuse. Reduce power or altitude if necessary.
High fuel pressure	<ol style="list-style-type: none"> 1. Instrument. 2. High boost on. 3. Relief valve malfunction. 	<ol style="list-style-type: none"> 1. None. 2. Return to LOW. 3. None.
Fuel leak	<ol style="list-style-type: none"> 1. Material failure. 	<ol style="list-style-type: none"> 1. Confirm leak, shut off fuel, feather propeller, transfer fuel.
Excessive fuel consumption	<ol style="list-style-type: none"> 1. Faulty carburetion. 2. Induction leak. 3. Fuel leak. 	<ol style="list-style-type: none"> 1. None. 2. Reduce manifold pressure to atmospheric. 3. Confirm leak, shut off fuel, feather propeller, transfer fuel.

Trouble	Probable Cause	Corrective Action
E. ENGINE OIL SYSTEMS		
Low oil pressure	1. Low oil quantity.	1. Feather propeller.
	2. Faulty instrument.	2. None.
	3. High oil temperature.	3. Decrease temperature.
	4. Relief valve on pump malfunction.	4. Reduce oil temperature to 55°C. Reduce power. Feather if advisable.
	5. Internal failure.	5. Feather if advisable.
High oil pressure	1. Instrument.	1. None.
	2. Faulty relief valve.	2. None.
	3. Low oil temperature.	3. Increase temperature.
Low oil temperature	1. Automatic oil shutter malfunction.	1. Control manually. Have scanners check doors. Check fuse.
	2. Instrument malfunction.	2. Check fuse.
High oil temperature	1. Low oil quantity.	1. Feather.
	2. Automatic oil cooler shutter operation.	2. Control manually. Have scanners check doors. Replace fuse. Reduce power.
	3. Low oil pressure.	3. See low oil pressure.
	4. Instrument.	4. None.
	5. Congealed cooler.	5. Close doors manually. Open doors when temperature change is noted.
Excessive oil consumption	1. Bad oil leak and internal engine failure.	1. Reduce oil temperature to 55°C. Reduce power. Feather.

F. CYLINDER-HEAD TEMPERATURE

High cylinder-head temperature	1. Low airspeed or excessive power.	1. Increase airspeed. Lower manifold pressure. Increase cowl flap opening.
	2. Lean mixture.	2. Check mixture control. Check fuel pressure.
	3. Low oil pressure or high oil temperature.	3. Reduce oil temperature.
	4. High CAT.	4. Reduce CAT.
	5. Leaking exhaust stack. (1 or 18)	5. Check visually. Reduce power if necessary.
	6. Instrument. (Thermocouple, calibration or open lead)	6. None.

Trouble	Probable Cause	Corrective Action
Low cylinder-head temperature	7. Improper ignition timing, improper valve adjustment or faulty baffling.	7. Open cowl flaps. Reduce power.
	8. Cowl flaps inoperative.	8. Check visually. Check fuse.
	1. Instrument.	1. None.
	2. Dead cylinder (1 or 18).	2. None.
	3. Rich mixture.	3. Check mixture control, fuel pressure.
	4. Cowl flaps.	4. Close.
	5. Ignition timing.	5. None.

G. CARBURETOR AIR TEMPERATURE

High CAT	1. Insufficient intercooler opening.	1. Open. Check visually. Check fuse. Reduce power.
	2. Induction fire.	2. Shut off fuel. Close throttle. Feather propeller.
	3. Instrument.	3. None. (Reads to upper limit of scale.)

Low CAT	1. Excessive intercooler opening.	1. Adjust. Check visually. Check fuse.
	2. Instrument.	2. Check fuse.

2. FUEL TRANSFER SYSTEMS

Failure to transfer fuel	1. Circuit breakers OFF.	1. Turn circuit breakers ON.
	2. Selector handle improperly set.	2. With transfer pump switches OFF, hold transfer lights depressed and slightly move tank selector handles in the vicinity of the indent positions. When depressed transfer lights burn steady, system is ready for transferring. Audible click or relay will be noticed when light comes on.
	3. Tank selector cables severed.	3. Splice cables or set selector valves by pulling severed cables by hand.
	4. Relay fails to close. (No click; no fuel transfer light operation when depressed).	4. Set tank selector handles. Lift section of engineer's switch panel on which pump switches are mounted and close relays manually. Then operate fuel transfer switches.
	5. Fuel leak.	5. Locate and repair.

Trouble	Probable Cause	Corrective Action
	<p>6. Inoperative pump power circuit.</p>	<p>6. Set fuel transfer handles. In front bomb bay at fuel transfer pump, short one field lead (small wire) to ground. Connect other field lead (small) to armature lead (large) wire to electrical power supply. Check direction of fuel flow by fuel transfer lights. To reverse flow, interchange field (small wires) leads.</p>
	<p>7. Inoperative fuel transfer pumps.</p>	<p>7. To transfer from outboard wing or from wing tank to center wing tank, clamp lines. Remove proper fuel lines from selector valve and splice unclamped lines. Gravity transfer of fuel will occur from high tank to low tank. To transfer from center wing or bomb bay tank, bypass front pump by connecting inlet and outlet hoses together. Set tank selector handles as desired. Remove proper vent line (center wing or bomb bay) at outlet through fuselage. Place nozzle of CO₂ fire extinguisher over vent line hose. Discharge CO₂ intermittently to force fuel tank. Place tank selector handles OFF when finished. To transfer fuel across center line high tank to low tank, bypass front fuel pump. Set tank selector handles as desired.</p>

Simultaneous fuel transfer to two tanks

1. Poppet in selector valve stuck open.

1. When transfer switches OFF, jog tank selector handles. Proceed with fuel transfer taking care not to overfill either tank.

3. TURBO AND MANIFOLD PRESSURE SYSTEMS

Turbo control inoperative (all engines)

1. Inverter failure.
2. Fuse blown or circuit breaker popped.
3. TBS failure.
4. Amplifier fuses blown.

1. Check voltage. Switch to alternate inverter.
2. Replace fuse; re-set circuit breaker.
3. Rotate knob to check for dead spots.
4. Check fuses.

Turbo control inoperative (one engine)

1. Amplifier.
2. Amplifier fuse.

1. Replace amplifier.
2. Replace fuse.

Trouble	Probable Cause	Corrective Action
	3. Individual fuse blown (inverter relay shield).	3. Replace fuse.
	4. Governor and pressure control inoperative.	4. Retard throttle. Remove right hand discriminator tube. Adjust throttle.
	5. Waste gate motor inoperative.	5. None.
<hr/>		
Decrease in manifold pressure at constant TBS and throttle setting	1. Blown cylinder, induction leak.	1. Visual check for fire hazard. Feather if necessary.
	2. Faulty pressure control or governor.	2. Retard throttle. Remove right hand discriminator tube. Adjust throttle.
	3. Icing.	3. Close intercoolers. Set rated power. Maintain CAT at 25° to 38°C. Reduce power.
	4. Exhaust manifold leak.	4. Check for fire hazard. Reduce power if necessary.
	5. Engine or turbo internal failure.	5. Check for fire hazard.
<hr/>		
Excessive manifold pressure	1. Runaway turbo.	1. Adjust with throttle.
<hr/>		
Fluctuating manifold pressure	1. Turbo surge at altitude.	1. Open throttles and reduce TBS setting. Increase oil temperature to 85°C. Increase power setting. Reduce altitude.
	2. Propeller governor hunting.	2. Increase oil temperature to 85°C.
	3. Backfiring.	3. See backfiring checklist.
	4. Turbo governor or pressure control malfunctioning.	4. None if minor. Remove amplifier if severe.
<hr/>		
4. INVERTER SYSTEMS		
High or low voltage	1. High or low DC voltage.	1. Switch to alternate to check. Increase or decrease DC voltage.
	2. Faulty inverter.	2. Switch to alternate.
<hr/>		
Zero voltage	1. Switch OFF.	1. Turn ON.
	2. Circuit breaker open or normal inverter inoperative.	2. Switch to alternate. Check DC power circuit breaker at inverter. Check automatic change-over relay circuit breaker if installed. (Engineer's panel.)
<hr/>		
Inverter signal lights inoperative	1. Circuit breaker open.	1. Re-set.
	2. Light turned out.	2. Push to check.

Trouble	Probable Cause	Corrective Action
5. NORMAL ELECTRICAL POWER SYSTEMS		
Excessive voltage	<ol style="list-style-type: none"> 1. Voltage regulator. 2. Short A to B or field to armature. 	<ol style="list-style-type: none"> 1. Turn off generator. Remove voltage regulator, if necessary. 2. Turn off generator. Remove voltage regulator, if necessary.
Excessively low voltage	<ol style="list-style-type: none"> 1. Open field. 2. Burned out generator. 	<ol style="list-style-type: none"> 1. Turn off generator. Remove voltage regulator, if necessary. 2. Turn off generator. Remove voltage regulator, if necessary.
No ammeter reading	<ol style="list-style-type: none"> 1. No load. 2. Faulty relay. 3. No voltage or low voltage. 4. Generator switch OFF. 	<ol style="list-style-type: none"> 1. None required. 2. Turn off generator. Remove voltage regulator. 3. See low voltage check. 4. Turn on generators.
Excessive ammeter reading	<ol style="list-style-type: none"> 1. Excessive voltage. 2. Excessive load or short circuit. 	<ol style="list-style-type: none"> 1. Turn off generator. (See excessive voltage) 2. Turn off generator and battery. Attempt to repair trouble.
Inability to turn generator off	<ol style="list-style-type: none"> 1. Stuck relay. 	<ol style="list-style-type: none"> 1. Turn off generator switch. Remove voltage regulator.
6. HYDRAULIC SYSTEMS		
Pump runs intermittently in flight	<ol style="list-style-type: none"> 1. Leak (small). 	<ol style="list-style-type: none"> 1. Remove fuse in engineer's aft fuse panel. Bleed normal system using brakes. Check and repair leak. Replace fuse. Recharge system manually for landing.
Pump runs continuously	<ol style="list-style-type: none"> 1. Excessive leakage. 2. Stuck pressure switch. 3. Stuck relay (solenoid) 4. Hydraulic service valve at Sta. 215 partially open. 	<ol style="list-style-type: none"> 1. As above. 2. Remove fuse from engineer's aft fuse panel. Maintain pressure by using manual over-ride for landing. 3. Remove cannon plug from hydraulic pump motor or cut pump power lead (P-178) near urinal. Prepare for splicing before landing. Cut electrical power before connecting splice. 4. Close valve.
Emergency hydraulic pressure drop continuously	<ol style="list-style-type: none"> 1. Emergency brake handles moved. 2. Leak. 	<ol style="list-style-type: none"> 1. Check with airplane commander. 2. Bleed system using emergency brake handles. Recharge for landing.

Trouble	Probable Cause	Corrective Action
---------	----------------	-------------------

7. VACUUM SYSTEMS

No vacuum	1. Inoperative vacuum pump.	1. Use other vacuum source.
	2. Leak in vacuum system.	2. Close emergency camera and de-icer valve beside navigator's cabinet. Check for vacuum at vacuum pressure regulator. If vacuum is present, leak is in cabin. If no vacuum is present, leak is in bomb bay. Check and repair.

Note: In emergency, vacuum instruments can be operated at any altitude by creating a 3 to 4 in. Hg. of cabin differential pressure.

Low vacuum (both pumps)	1. Clogged filter.	1. Check filter beneath airplane commander's instrument panel.
	2. Leak.	2. Locate and repair.
	3. Broken selector valve.	3. Check selector valve. Bypass if possible. Maintain 3 to 4 inches cabin differential pressure.

8. CABIN PRESSURIZATION AND HEATING

Inability to pressurize cabin. (No cabin air flow)	1. Air valves closed.	1. Check air flow valve position.
	2. TBS setting too low.	2. Increase TBS setting.
	3. Power setting too low.	3. Increase inboard engine power setting.
	4. Leak in air duct to tunnel.	4. None.
	5. Fire or smoke valve closed.	5. None.

Inability to pressurize cabin. (7 to 10 air indications)	1. Windows and doors open.	1. Close.
	2. Turret covers improperly installed.	2. Replace properly.
	3. Emergency cabin release valve, vacuum relief valve, or engineer's pressure relief valve open.	3. Close.
	4. Malfunctioning cabin pressure regulators.	4. Lock down one at a time to locate faulty regulator.

Cabin heat uncontrollable	1. Aftercooler inoperative.	1. Check fuse. Replace if necessary.
---------------------------	-----------------------------	--------------------------------------

Insufficient defrosting airflow	1. Airflow improperly distributed.	1. Close valve at navigator's, radio operator's and engineer's stations.
	2. Blister defroster fans inoperative.	2. Check fuse. Replace if necessary.

INDEX

	Page		Page
After Landing, Flight Engineer's Amplified Checklist	84	Checklist, Flight Engineer's Abbreviated	73
After Landing, Pilot's Amplified Checklist	53	Checklist, Pilot's Abbreviated.....	27
After Takeoff, Flight Engineer's Amplified Checklist	82	Climb Control Curves, Type A-6.....	103
Aircraft Malfunction Report.....	114	Controls, Description	14
Airplane Commander, Duties and Responsibilities	5	Controls, Flight	15
Bailout	140	Cowl Flaps	180
Before Landing, Flight Engineer's Amplified Checklist	83	Crash Landings	142
Before Landing, Pilot's Amplified Checklist	50	Crew Discipline	8
Before Starting, Flight Engineer's Amplified Checklist	75	Cruise Control	85
Before Starting, Pilot's Amplified Checklist	29	Cruising	43
Before Takeoff, Flight Engineer's Amplified Checklist	80	Curtiss Electric Propeller System.....	144
Before Taxiing, Pilot's Amplified Checklist	34	Descent Control Curve.....	104
BMEP Power Schedule, Type M-1.....	95	Description, General	11
C-1 Autopilot	147	Ditching Procedure	132
Cabin Pressurization and Air Conditioning	158	Emergency Bomb Bay Door Operation and Bomb Salvo Control.....	121
		Emergency Electrical System.....	178
		Emergency Flap Operation.....	120
		Emergency Landing Gear Procedure Airplanes Without Manual Landing Gear System	117
		Airplanes With Manual Landing Gear System	118
		Emergency Landings	55
		Emergency Maximum Range Speed Table, Type A-4-4.....	93
		Emergency Procedures	115
		Electrical System	162

	Page		Page
Fire	123	Oil Cooler Doors.....	176
Flight Characteristics	45	Oil System	172
Flight Engineer's Log.....	113	Operational Check of Equipment, Flight Engineer's Preflight.....	70
Flight Engineer's Preflight Inspection and Checklist	61	Oxygen	157
Flight Operation Instruction Chart.....	105	Panel, Airplane Commander's.....	15
Flight Progress Curves.....	112	Panel, Copilot's Instrument.....	15
Flight Rules	9	Panel, Flight Engineer's.....	12
Formation Stick	153	Pneumatic Bomb Door System.....	157
Fuel Flow Curves, Type M-2.....	97	Power Distributing System.....	179
Fuel System	167	Power Plant Trouble Shooting.....	174
Fuel Transfer System.....	168	Preflight Inspection, Flight Engineer's.....	62
Go-around	54	Prop Feathering System.....	181
Hydraulic System	166	Propeller Feathering	130
Inspection, Airplane Commander's Exterior Visual	16	Residual Fuel Tables.....	109
Inspection Diagram	17	RPM Control Trouble Shooting.....	182
Intercooler Doors	181	Starting the Engines, Pilot's Amplified Checklist	32
Landing Procedure	52	Systems and Trouble Shooting in Flight... ..	143
Landing With Less Than Four Engines....	58	Takeoff, Climb and Landing Chart.....	104
Long Range Prediction Curves, Type A-3-4	88, 89	Takeoff Distance Curves, Type A-5.....	101
Long Range Summary Curve, Type A-2-4..	91	Takeoff Emergencies	41
Manifold Fuel System.....	171	Takeoff Procedure	39
Manifold Pressure-Altitude Table.....	94	Taxiing Procedure	36
Nautical Miles Per Gallon Curve, Type A-1-4	99	Trouble Shooting in Flight, Tabular.....	183
Night Flying	59	Turbo-superchargers	172
		Vacuum System	161
		Warning Horns	181

82 4 54283 2 013 1 BA 3023

	Page		Page
Fire	123	Oil Cooler Doors.....	176
Flight Characteristics	45	Oil System	172
Flight Engineer's Log.....	113	Operational Check of Equipment, Flight Engineer's Preflight.....	70
Flight Engineer's Preflight Inspection and Checklist	61	Oxygen	157
Flight Operation Instruction Chart.....	105	Panel, Airplane Commander's.....	15
Flight Progress Curves.....	112	Panel, Copilot's Instrument.....	15
Flight Rules	9	Panel, Flight Engineer's.....	12
Formation Stick	153	Pneumatic Bomb Door System.....	157
Fuel Flow Curves, Type M-2.....	97	Power Distributing System.....	179
Fuel System	167	Power Plant Trouble Shooting.....	174
Fuel Transfer System.....	168	Preflight Inspection, Flight Engineer's.....	62
Go-around	54	Prop Feathering System.....	181
Hydraulic System	166	Propeller Feathering	130
Inspection, Airplane Commander's Exterior Visual	16	Residual Fuel Tables.....	109
Inspection Diagram	17	RPM Control Trouble Shooting.....	182
Intercooler Doors	181	Starting the Engines, Pilot's Amplified Checklist	32
Landing Procedure	52	Systems and Trouble Shooting in Flight... ..	143
Landing With Less Than Four Engines....	58	Takeoff, Climb and Landing Chart.....	104
Long Range Prediction Curves, Type A-3-4	88, 89	Takeoff Distance Curves, Type A-5.....	101
Long Range Summary Curve, Type A-2-4..	91	Takeoff Emergencies	41
Manifold Fuel System.....	171	Takeoff Procedure	39
Manifold Pressure-Altitude Table.....	94	Taxiing Procedure	36
Nautical Miles Per Gallon Curve, Type A-1-4	99	Trouble Shooting in Flight, Tabular.....	183
Night Flying	59	Turbo-superchargers	172
		Vacuum System	161
		Warning Horns	181