

RESTRICTED

AN 01-15EBB-1

**HANDBOOK**  
**FLIGHT OPERATING INSTRUCTIONS**  
**USAF SERIES**  
**YRB-49A**  
**AIRCRAFT**

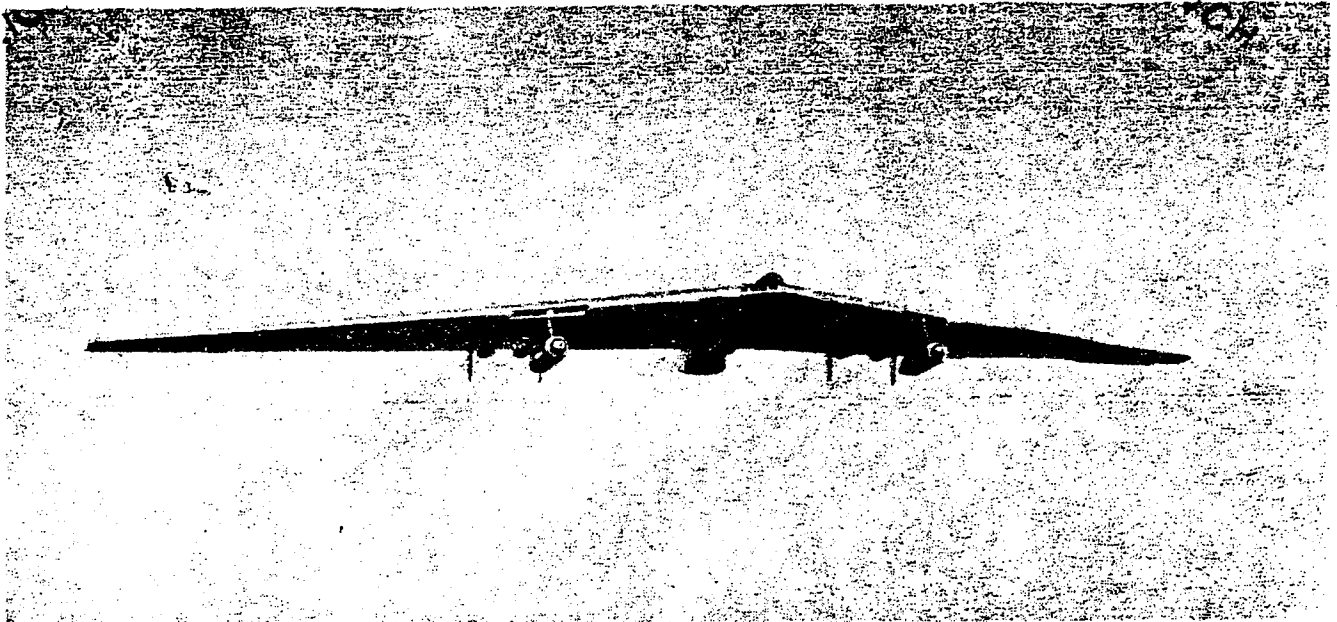

Appendix I of this publication shall not be carried in aircraft on missions where there is a reasonable chance of its falling into the hands of an unfriendly nation.

PUBLISHED UNDER AUTHORITY OF THE SECRETARY OF THE AIR FORCE AND THE CHIEF OF  
THE BUREAU OF AERONAUTICS

**NOTICE:** This document contains information affecting the national defense of the United States within the meaning of the Espionage Laws, Title 18 U.S.C., Sections 793 and 794. Its transmission or the revelation of its contents in any manner to an unauthorized person is prohibited by law.

RESTRICTED

15 SEPTEMBER 1950

Reproduction of the information or illustrations contained in this publication is not permitted without specific approval of the issuing service. The policy for use of Classified Publications is established for the Air Force in AFR 205-1 and for the Navy in Navy Regulations, Article 1509.

LIST OF REVISED PAGES ISSUED

INSERT LATEST REVISED PAGES. DESTROY SUPERSEDED PAGES.

NOTE: The portion of the text affected by the current revision is indicated by a vertical line in the outer margins of the page.

\*The asterisk indicates pages revised, added or deleted by the current revision.

USAF

ADDITIONAL COPIES OF THIS PUBLICATION MAY BE OBTAINED AS FOLLOWS:

USAF ACTIVITIES - In accordance with Technical Order No. 00-5-2.

NAVY ACTIVITIES - Submit request to nearest supply point listed below, using form NavAer-140:  
NAS, Alameda, Calif.; ASD, Orote, Guam; NAS, Jacksonville, Fla.; NAS, Norfolk, Va.; NASD,  
Oahu; NASD, Philadelphia, Pa.; NAS, San Diego, Calif.; NAS, Seattle, Wash.

For listing of available material and details of distribution, see Naval Aeronautics  
Publications Index NavAer 00-500.

## INTRODUCTION

This handbook contains information which you, as pilot or crew member, should know for safe and efficient operation of your airplane. The technical knowledge of Air Force personnel is combined with the engineering knowledge of those who designed and built the airplane to give you the necessary information in a single package. Read this handbook from cover to cover, for it contains a description of the airplane, specific operating instructions, and airplane characteristics under all conditions of flight. Illustrations are included, as a supplement to the text, to help you understand and retain the facts. READ the text and KNOW your airplane.

### SECTION I, DESCRIPTION.

This section describes the airplane, its equipment, systems, and controls which are essential to flight and which will be needed for one complete noncombat mission in good weather at medium altitude. All emergency equipment (which is not part of the operational equipment) and all miscellaneous equipment is covered in this section.

### SECTION II, NORMAL OPERATING INSTRUCTIONS.

This section contains the steps to be accomplished from the time the aircraft is approached by the flight crew until it is left parked on the ramp after accomplishing one complete noncombat mission in good weather at medium altitude.

### SECTION III, EMERGENCY OPERATING INSTRUCTIONS.

This section describes the procedure to be followed in meeting any emergency (except those in connection with the operational equipment) that could reasonably be expected to be encountered.

### SECTION IV, OPERATIONAL EQUIPMENT.

This section includes the description, normal operation, and emergency operation of all equipment not directly contributing to flight but which enables the airplane to perform certain specialized functions. This equipment consists of oxygen systems, photographic equipment, communication equipment, etc.

### APPENDIX I, OPERATING DATA.

This section contains all operating data charts necessary for preflight and in-flight mission planning and includes explanatory text on the use of the data presented.

### APPENDIX II, SPECIAL DATA.

This section includes special data (in graph form) that imposes restrictions on the angle of yaw vs airspeed, altitude, and alternator and starter-generator loads.

TABLE OF CONTENTS

SECTION I		SECTION III	
DESCRIPTION		EMERGENCY OPERATING INSTRUCTIONS	
PARAGRAPH	PAGE	PARAGRAPH	PAGE
1-1. Airplane.....	1	3-1. Engine Failure.....	55
1-13. Engines.....	4	3-15. Fire.....	56
1-35. Fuel System.....	9	3-24. Bail-out.....	58
1-54. Electrical Systems.....	12	3-28. Forced Landings.....	58
1-96. Hydraulic Systems.....	17	3-33. Ditching.....	59
1-109. Flight Control Systems.....	18	3-37. Fuel System Emergency Operation.	62
1-162. Landing Gear.....	26	3-40. Flight Controls Emergency	
1-175. Steering System.....	30	Operation.....	62
1-180. Brake System.....	31	3-47. Landing Gear Emergency Operation	62
1-187. Instruments.....	31	3-52. Brakes and Steering Hydraulic	
1-200. Emergency Equipment.....	31	System Emergency Operation....	63
1-224. Seats.....	34	3-55. Shoulder Harness Emergency	
1-227. Operational Equipment.....	34	Operation.....	63
SECTION II		SECTION IV	
NORMAL OPERATING INSTRUCTIONS		OPERATIONAL EQUIPMENT	
2-1. Before Entering the Airplane....	35	4-1. Photographic Equipment.....	65
2-13. On Entering the Airplane.....	37	4-40. Photoflash Bombing Equipment....	71
2-18. Fuel System Management.....	38	4-61. Navigational Equipment.....	74
2-25. Starting Engines.....	44	4-67. Oxygen System.....	74
2-33. After All Engines are Started...	45	4-82. Communication and Associated	
2-34. Taxiing.....	46	Electronic Equipment.....	76
2-42. Before Take-off.....	46	4-88. Air Conditioning System.....	77
2-43. Take-off.....	47	4-103. Lighting Equipment.....	78
2-52. Climb.....	47	4-113. Ice Elimination Equipment.....	79
2-61. During Flight.....	50	4-133. Miscellaneous Operational	
2-78. Stalls.....	50	Equipment.....	80
2-85. Spins.....	50		
2-92. Acrobatics.....	51	APPENDIX I	
2-94. Diving.....	51	OPERATING CHARTS	
2-97. Approach.....	51	A-1. Flight Operation Instruction....	86.
2-101. Landing.....	51		
2-112. Stopping Engines.....	52	APPENDIX II	
2-113. Before Leaving the Airplane....	52	SPECIAL DATA	

LIST OF ILLUSTRATIONS

FIGURE NO.	SECTION I DESCRIPTION	PAGE	FIGURE NO.	SECTION IV OPERATIONAL EQUIPMENT	PAGE
			3-3.	Fuel System Emergency Operation (Sheet 2 of 2 Sheets).....	61
				<b>SECTION IV OPERATIONAL EQUIPMENT</b>	
1-1.	The Airplane.....	1v	4-1.	Photographic Equipment.....	66
1-2.	General Arrangement (Sheet 1 of 2 Sheets).....	2	4-2.	Camera Control Panel.....	67
1-2.	General Arrangement (Sheet 2 of 2 Sheets).....	3	4-3.	Viewfinder Controls.....	68
1-3.	Engineer's Station.....	5	4-4.	Camera Power Distribution Panel..	69
1-4.	Engineer's Switch Panel (Sheet 1 of 2 Sheets).....	6	4-5.	Radar-Navigator's Switch Panel...	70
1-4.	Engineer's Switch Panel (Sheet 2 of 2 Sheets).....	7	4-6.	Photoflash Bombing Intervalometer Panel.....	71
1-5.	Engineer's Center Instrument Panel.....	8	4-7.	Radar-Navigator's Station.....	72
1-6.	Fuel System.....	9	4-8.	Oxygen Duration.....	74
1-7.	Fueling Procedure.....	10	4-9.	Radio Operator's Station.....	75
1-8.	Fuel System Control Panel.....	12	4-10.	Radio Junction Box.....	76
1-9.	AC Electrical Control Panel.....	14		<b>APPENDIX I OPERATING CHARTS</b>	
1-10.	Locations of Electrical Limiters.	15	A-1.	Airspeed Installation Correction.	81
1-11.	DC Electrical Control Panel.....	16	A-2.	Airspeed Compressibility Correction.....	82
1-12.	Hydraulic Pressure Gage Panel....	17	A-3.	Temperature Correction.....	83
1-13.	Flight Control Surfaces.....	18	A-4.	Instrument Markings (Sheet 1 of 2 Sheets).....	84
1-14.	Elevon Action.....	19	A-4.	Instrument Markings (Sheet 2 of 2 Sheets).....	85
1-15.	Elevon Force Bellows Action.....	20	A-5.	Take-off Distance.....	88
1-16.	Trim Flap and Rudder Action.....	21	A-6.	Landing Distance.....	89
1-17.	Landing Flaps Emergency Controls.	22	A-7.	Fuel Flow Chart.....	90
1-18.	Auto-pilot Control Panel.....	22	A-8.	Climb Chart.....	91
1-19.	Pilot's Station - Forward.....	23	A-9.	Descent Chart (Sheet 1 of 3 Sheets).....	92
1-20.	Pilot's Pedestal (Sheet 1 of 2 Sheets).....	24	A-9.	Descent Chart (Sheet 2 of 3 Sheets).....	93
1-20.	Pilot's Pedestal (Sheet 2 of 2 Sheets).....	25	A-9.	Descent Chart (Sheet 3 of 3 Sheets).....	94
1-21.	Pilot's Station - Left Side.....	26	A-10.	Long Range Cruise Chart.....	95
1-22.	Pilot's Station - Right Side.....	27	A-11.	Flight Operation Instruction Chart (Sheet 1 of 2 Sheets)....	96
1-23.	Copilot's Instrument Panel.....	28	A-11.	Flight Operation Instruction Chart (Sheet 2 of 2 Sheets)....	97
1-24.	Copilot's Pedestal.....	29	A-12.	Flight Operation Instruction Chart (Sheet 1 of 2 Sheets)....	98
1-25.	Copilot's Station - Left Side....	29	A-12.	Flight Operation Instruction Chart (Sheet 2 of 2 Sheets)....	99
1-26.	Copilot's Station - Right Side...	30	A-13.	Flight Operation Instruction Chart (Sheet 1 of 2 Sheets)....	100
1-27.	Landing Gear Emergency Release...	30	A-13.	Flight Operation Instruction Chart (Sheet 2 of 2 Sheets)....	101
1-28.	Fire Extinguisher System Control Panel.....	32		<b>APPENDIX II SPECIAL DATA</b>	
1-29.	Life Raft Release Handles.....	33	B-1.	Angle of Yaw vs Airspeed Restrictions.....	103
	<b>SECTION II NORMAL OPERATING INSTRUCTIONS</b>		B-2.	Altitude Restrictions.....	104
2-1.	Entrance to the Airplane.....	36	B-3.	Alternator and Starter-Generator Load Restrictions.....	105
2-2.	Courses of Fuel Flow (Sheet 1 of 5 Sheets).....	39			
2-2.	Courses of Fuel Flow (Sheet 2 of 5 Sheets).....	40			
2-2.	Courses of Fuel Flow (Sheet 3 of 5 Sheets).....	41			
2-2.	Courses of Fuel Flow (Sheet 4 of 5 Sheets).....	42			
2-2.	Courses of Fuel Flow (Sheet 5 of 5 Sheets).....	43			
2-3.	Danger Areas.....	44			
2-4.	Dive and High Speed Restrictions.	48			
2-5.	Flight Maneuver Load Factor Restrictions.....	49			
2-6.	Approach Pattern.....	52			
	<b>SECTION III EMERGENCY OPERATING INSTRUCTIONS</b>				
3-1.	Emergency Exits.....	57			
3-2.	Miscellaneous Emergency Equipment	59			
3-3.	Fuel System Emergency Operation (Sheet 1 of 2 Sheets).....	60			

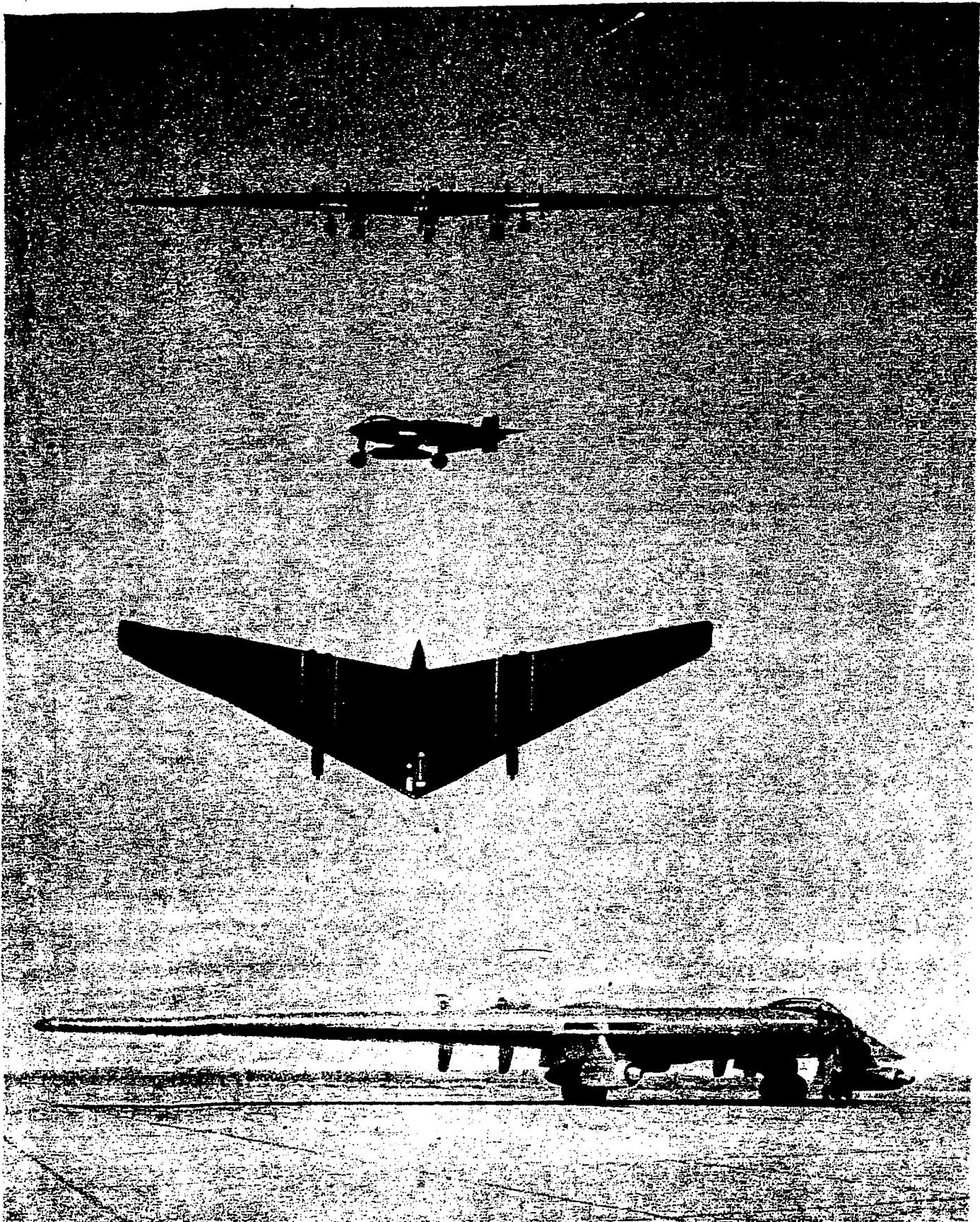

Figure 1-1. The Airplane

SECTION I  
DESCRIPTION

1-1. AIRPLANE.

1-2. GENERAL.

1-3. The Northrop YRB-49A Flying Wing is a six-engine, jet-propelled modification of the Northrop YB-35 heavy bombardment airplane. It is designed and equipped for high-speed, high-altitude, long-range photographic reconnaissance operation. The control surfaces - split rudders, trim flaps, elevons (combined elevators and aileron), and landing flaps - are all incorporated in the trailing edge of the wing. Four vertical fins at the trailing edge, with dorsals extending forward along the the upper surface of the wing, provide directional flight stability. All operational equipment is housed in the wing center section, which is referred to as the crew nacelle. Four of the engines are mounted within the wing and two of the engines are enclosed in pods suspended from each side of the wing. The retractable landing gear comprises two main gear units, each equipped with dual wheels and brakes, and a nose gear with a single steerable wheel. Photographic control equipment, camera installations, and windows are provided for all methods of aerial photography; provisions for carrying and dropping photoflash bombs are installed in the photoflash bomb bay.

1-4. AIRPLANE DIMENSIONS.

1-5. Overall dimensions of the airplane are as follows:

Span..... 172 feet  
Length..... 53 feet  
Height (ground to top of fins)... 15 feet

1-6. AIRPLANE WEIGHTS.

1-7. Design and maximum allowable weights of the airplane are as follows:

Weight empty..... 84,000 pounds  
Maximum allowable landing weight..... 150,000 pounds  
Maximum allowable gross weight..... 165,000 pounds  
Design gross weight..... 206,000 pounds

NOTE

The maximum allowable gross weight limitation is imposed because the airplane has not been static tested. Specific authorization must be

obtained from Air Materiel Command to exceed this weight.

1-8. MAIN DIFFERENCES TABLE.

ITEMS OF DIFFERENCE	YRB-49A	YB-49
Type	Photographic reconnaissance	Bombing
Engines	Six J35-A-19's; four internally mounted in wing, two externally mounted in pods	Eight J35-A-5's; all internally mounted in wing
Crew nacelle contour	Rear portion has radome protruding from bottom	Rear portion streamlined
Crew	Five: pilot, copilot, engineer, photo-navigator, radar-navigator	Six: pilot, copilot, engineer, radio operator, navigator, bombardier
Pilots' seats	Tandem	Side-by-side
Bomb bays	One	Six
Fuel tanks	Twelve	Eight
Fuel capacity	*15,231 U.S. gallons	14,542 U.S. gallons

\*Gasoline; see fuel load restrictions for JP-3 and JP-1 fuels, paragraph 1-44.

1-9. CREW NACELLE.

1-10. The crew nacelle, which forms the wing root and is an integral part of the wing, is divided into three compartments which are referred to as the forward crew nacelle section, the center crew nacelle section, and the aft crew nacelle section. Stations for all regular crew members are in the forward crew nacelle section, which has a transparent enclosure over the pilots' stations and a transparent astrodome over the navigator's station. The main entrance hatch is located in the bottom of the center crew nacelle section, which also contains mounting provisions and windows for five cameras and storage tanks for the oxygen system. A radome is installed along the bottom of the aft crew nacelle section and the fairing covering the radome extends to the aft end of the crew nacelle. Four camera stations are provided in the aft crew nacelle section and the openings for the cameras are located in the fairing behind the radome. Electrically-

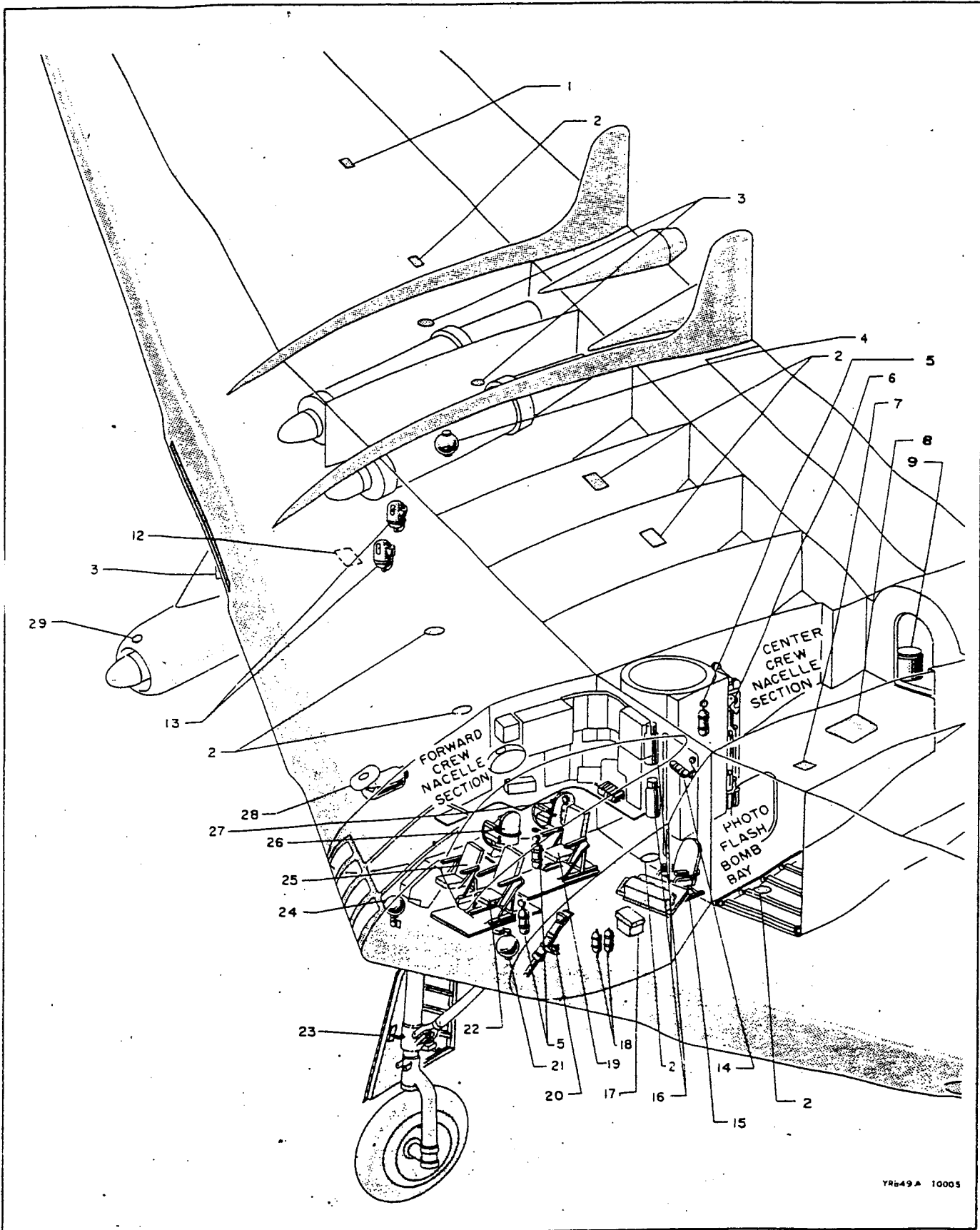

YRb49A 10005

Figure 1-2 (Sheet 1 of 2 sheets). General Arrangement



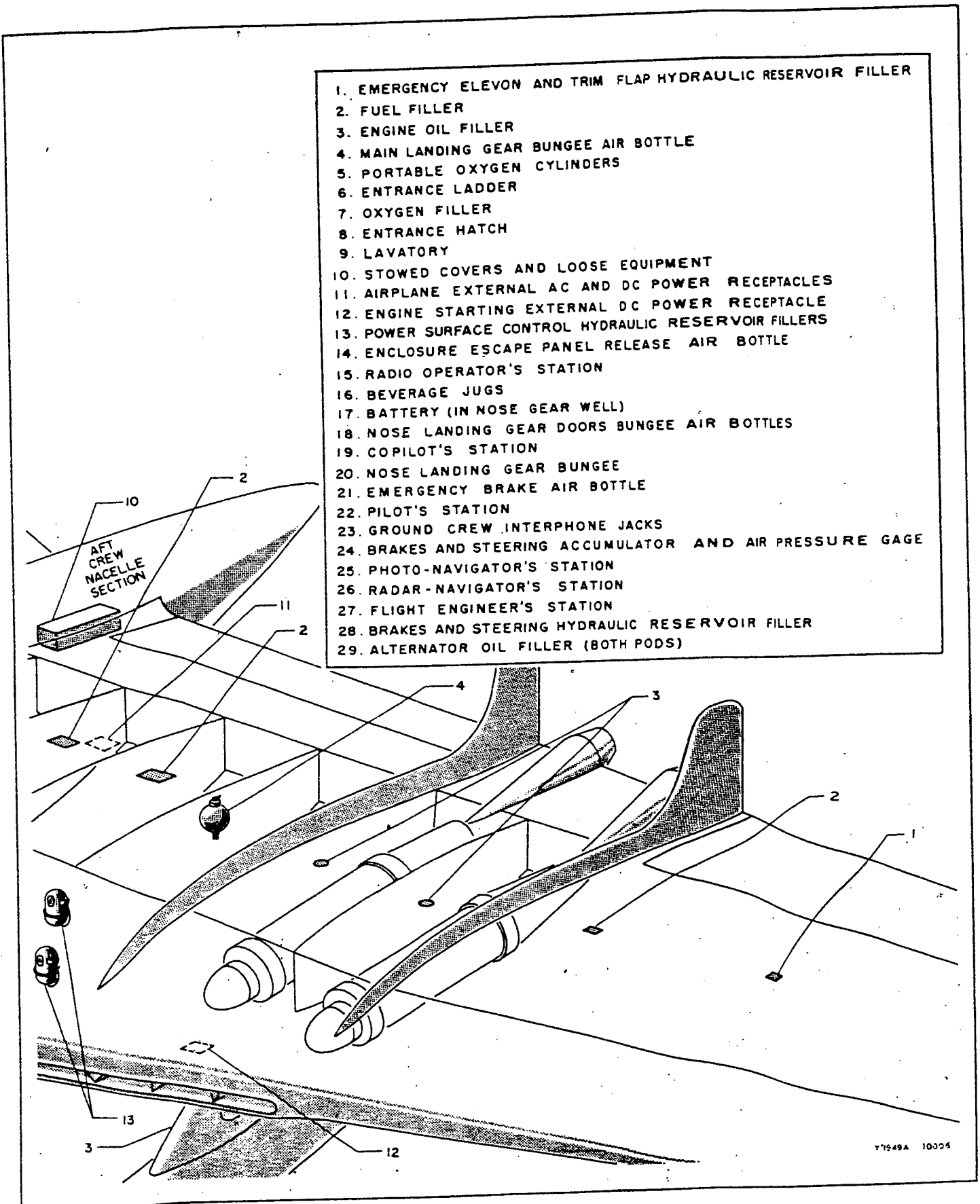

Figure 1-2 (Sheet 2 of 2 sheets). General Arrangement

Operated sliding doors cover the camera windows in the center crew nacelle section and the aft crew nacelle section when cameras are in use. For high altitude operation, pressurization of the entire crew nacelle is provided, and crew members may move throughout the three nacelle compartments during flight. Late glass is installed in all camera windows and in the pilot's windshield center panel; laminated glass is installed in the navigator's window in the leading edge; all other windows in the crew nacelle are made of transparent plastic material. In addition to the entrance hatch, three emergency escape hatches are provided in the crew nacelle. The overhead panel of the pilots' enclosure is adjustable for emergency escape.

#### 1-11. MOVEMENT OF FLIGHT PERSONNEL.

1-12. Movement of flight personnel is unrestricted, as there is ample space for free movement in the crew nacelle and all three compartments of the crew nacelle are pressurized.

#### 1-13. ENGINES.

#### 1-14. GENERAL.

1-15. The airplane is powered by six J35-A-19 turbo-jet engines which produce a total thrust of 29,400 pounds at take-off rpm. The engines are identified as: "L.H. POD," "No. 1," and "No. 2" in the left wing; and "No. 3," "No. 4," and "R.H. POD" in the right wing.

#### 1-16. ENGINE INDUCTION AND COOLING AIR SYSTEMS.

1-17. ENGINE INDUCTION AIR SYSTEMS. Induction air to the engine compressors is admitted through openings in the leading edge of the wing and the leading edge of each external engine pod. There are no controls for the induction air systems.

1-18. ENGINE COMPARTMENT COOLING AIR SYSTEM. The primary purpose of admitting cooling air into the internal engine compartments is to provide cooling of the airplane structure surrounding the engines. In flight, air from the leading edge intake openings is directed through the internal engine compartments for such structural cooling. Ground cooling of the internal engine compartments is accomplished by allowing air to enter the compartments through hinged doors in the wing upper surface. These doors are normally open when the airplane is not in flight but are closed by differential air pressure when the airplane reaches flying speed. Ground cooling of the pod engines is limited to the cooling effect of the air drawn into the pods for engine induction. There are no controls for the engine compartment cooling air systems.

#### 1-19. ENGINE OIL SYSTEMS.

1-20. Each engine is lubricated by a self-contained oil system. A 14.7-gallon oil tank is attached to the top of each engine accessory section. Specification AN-0-9 (MIL-O-6081), Grade 1010, oil is used. There are no controls for the oil systems.

#### 1-21. ENGINE STARTERS.

1-22. The engines are equipped with direct-cranking starter-generators which are supplied with electrical power for starting by the two (left-hand and right-hand) 28-volt dc engine starting external power circuits. The starters can be operated only by means of external power.

#### 1-23. ENGINE IGNITION SYSTEMS.

1-24. The individual engine ignition systems operate on 120-volt ac power, which is supplied by the airplane's ac electrical system in flight and by an external ac power source, connected to the airplane, for ground starting.

#### 1-25. ENGINE FUEL REGULATORS.

1-26. Each engine is equipped with a fuel regulator which automatically controls the quantity, mixture, and pressure of the fuel flow necessary to maintain the engine power output as set by the throttle levers at the pilots' and engineer's stations.

#### 1-27. ENGINE CONTROLS.

1-28. STARTING AND IGNITION SWITCHES. Two starting and ignition switches (17 and 18, figure 1-4) for each engine are located on the engineer's switch panel. The switches are arranged in two horizontal rows; those in the upper row have "AIR START" and "STARTER TEST" positions and those in the lower row have "NORMAL START" and "EMER. STOP" positions. The switches are spring-loaded to neutral positions. When power is on the airplane's ac electrical system, moving one of the upper switches to its "AIR START" position, and immediately releasing it, provides the corresponding engine with ignition for 45 seconds, at the end of which time the ignition is automatically cut off. The "AIR START" positions are used for starting windmilling engines in flight and for ground testing the ignition systems separately from the starters. The "STARTER TEST" positions of the upper switches are used for ground testing the operation of the starters without energizing the ignition systems. When one of the lower switches is placed in "NORMAL START" position (with external ac and dc power connected to the airplane), both the starter and the ignition system of the corresponding engine are supplied with current sufficient to start the engine. Once a switch has been moved to the "NORMAL START" position, current flows to the starter and the ignition system until the engine starts and/or reaches a certain speed. After the engine starts, current to the starter and ignition system is automatically cut off. If it is necessary to stop the starting procedure before the engine has started, tripping the lower switch to the "EMER. STOP" position breaks the electrical circuits, discontinuing current to the starter and the ignition system. Push-button type circuit breakers (1 and 2, figure 1-4) at the top of the engineer's switch panel protect the starter and ignition control circuits.

1-29. THROTTLE LEVERS. Cable systems connect the fuel regulators on the engines to the throttle levers located at the engineer's, pilot's, and copilot's stations; and power settings of the fuel regulators are determined by the positions of the throttle levers. Each pilot is furnished with two overhead throttle levers (3, figure 1-22, and 2, figure 1-26),

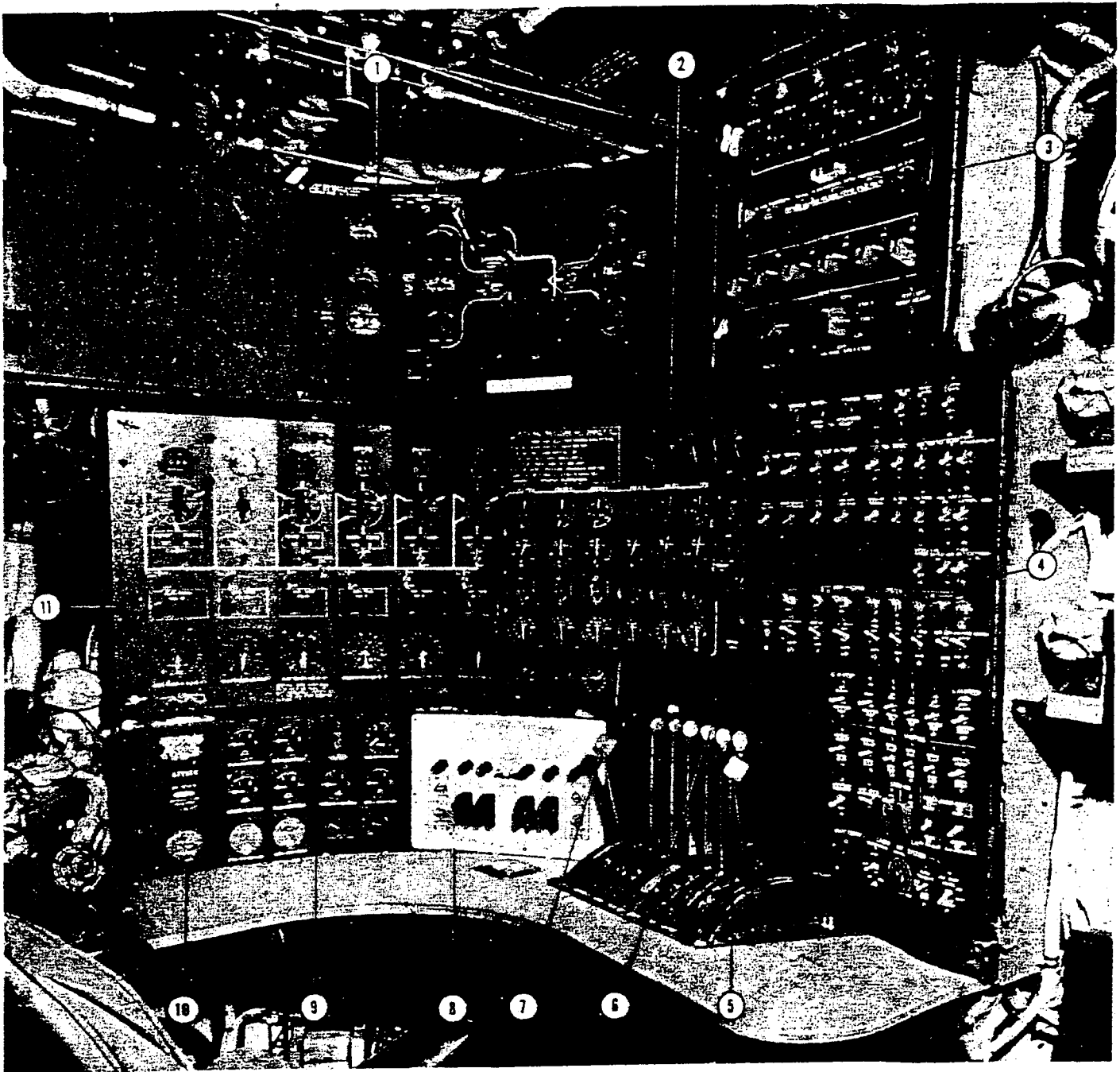

- |   |  |
|---|--|
| 1. A C ELECTRICAL CONTROL PANEL                   | 7. MASTER THROTTLE LEVER, RIGHT- HAND WING ENGINES |
| 2. CENTER INSTRUMENT PANEL                        | 8. FIRE EXTINGUISHER SYSTEM CONTROL PANEL          |
| 3. D C ELECTRICAL CONTROL PANEL                   | 9. HYDRAULIC PRESSURE GAGE PANEL                   |
| 4. SWITCH PANEL                                   | 10. OXYGEN GAGES                                   |
| 5. MASTER THROTTLE LEVER, LEFT- HAND WING ENGINES | 11. FUEL SYSTEM CONTROL PANEL                      |
| 6. INDIVIDUAL THROTTLE LEVERS                     |  |

Figure 1-3. Engineer's Station

each controlling three engines on one side of the airplane. These levers are interconnected with two master throttle levers (5 and 7, figure 1-3) at the engineer's station. Six throttle levers (6, figure 1-3) for the individual engines are also provided at the engineer's station. These individual throttle levers must be moved individually from the "CLOSE" positions to the idle detents on the quadrants. When the individual throttle levers are beyond the idle detents toward the "OPEN" positions, they are engaged by friction drives connected to the engineer's master throttle levers. Movement of engineer's master throttle levers provides synchronous throttle control at engine speeds greater than idling. The engineer can adjust individual engine throttle settings by exerting side pressure on the individual throttle lever toward the middle of the throttle lever bank (releasing the friction drive) while adjusting the lever setting. When side pressure on the individual throttle lever is released, the friction drive is engaged and any movement of the master throttle levers moves all throttle levers together, although the individual throttle lever settings may differ. When the pilots' throttle levers are

against the aft stops, the engines continue to idle. To stop an engine it is necessary for the engineer to press the corresponding throttle lever toward the middle of the throttle lever bank and move the lever past the idle detent on the quadrant to the "CLOSE" position.

1-30. ENGINE INDICATORS.

1-31. OIL PRESSURE GAGES. Six oil pressure gages (13, figure 1-5), on the engineer's center instrument panel, are actuated by electric pressure-transmitters installed at the engines. Operation of the oil pressure gages electrical circuit is controlled by a circuit breaker switch (9, figure 1-4) on the engineer's switch panel.

1-32. FUEL PRESSURE GAGES. Six fuel pressure gages (12, figure 1-5), on the engineer's center instrument panel, are actuated by electric pressure-transmitters installed at the engines. Operation of the fuel pressure gages electrical circuit is controlled by a circuit breaker switch (10, figure 1-4) on the engineer's switch panel.

- |   |   |
|---|---|
| 1. Ignition Control Circuit Breakers (2)                | 17. Air Start-Starter Test Switches (8)                 |
| 2. Starter Control Circuit Breakers (2)                 | 18. Normal Start-Emergency Stop Switches (6)            |
| 3. Free Air Temperature Circuit Breaker Switch          | 19. Engine Overheat Circuits Test Switches (2)          |
| 4. Cockpit Lights Circuit Breaker Switches (2)          | 20. Cabin Air Temperature Rheostat                      |
| 5. Auxiliary Fuel Control Circuit Breaker Switches (2)  | 21. Cabin Air Selector Switch                           |
| 6. Main Tank Fill Valves Circuit Breaker Switches (2)   | 22. Flight Control Force Scoop Heater Switch            |
| 7. Fuel Crossfeed Circuit Breaker Switch                | 23. Cabin Temperature Selector Switch                   |
| 8. Cabin Air Control Circuit Breaker Switch             | 24. Battery Switch                                      |
| 9. Oil Pressure Indicators Circuit Breaker Switch       | 25. Cabin Air Emergency Shut-Off Switches               |
| 10. Fuel Pressure Indicators Circuit Breaker Switch     | 26. Altitude Warning Circuit Breaker Switch             |
| 11. Fuel Flow Indicators Circuit Breaker Switch         | 27. Ground Crew Interphone Switch                       |
| 12. Fuel Level Indicators Circuit Breaker Switch        | 28. Anti-Icing Systems Circuit Breaker                  |
| 13. Battery Heater Circuit Breaker Switch               | 29. Engine Bay Overheat Systems Circuit Breaker Switch  |
| 14. Fire Detection Systems Circuit Breaker Switches (2) | 30. Fire Extinguisher System Circuit Breaker Switch     |
| 15. Anti-Icing Systems Overheat Warning Lights (8)      | 31. Emergency Brake and Steering Circuit Breaker Switch |
| 16. Anti-Icing Systems Switches (8)                     | 32. Pitot Heaters Circuit Breaker Switch                |
|   | 33. Fuel Shut-Off Valves Circuit Breaker Switches (2)   |
|   | 34. Fuel Pump Control Circuit Breaker Switches (2)      |

Figure 1-4 (Sheet 1 of 2 sheets). Engineer's Switch Panel

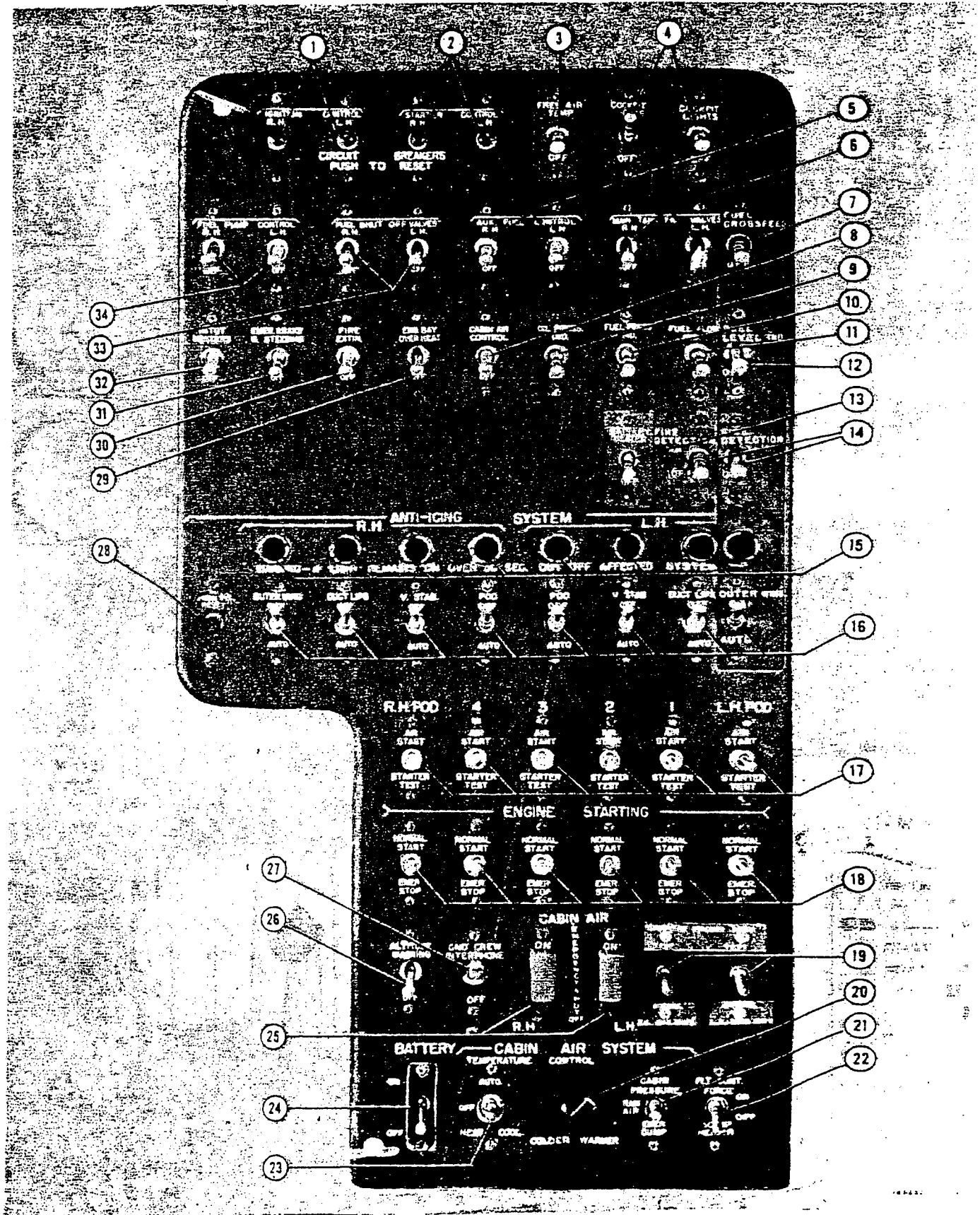
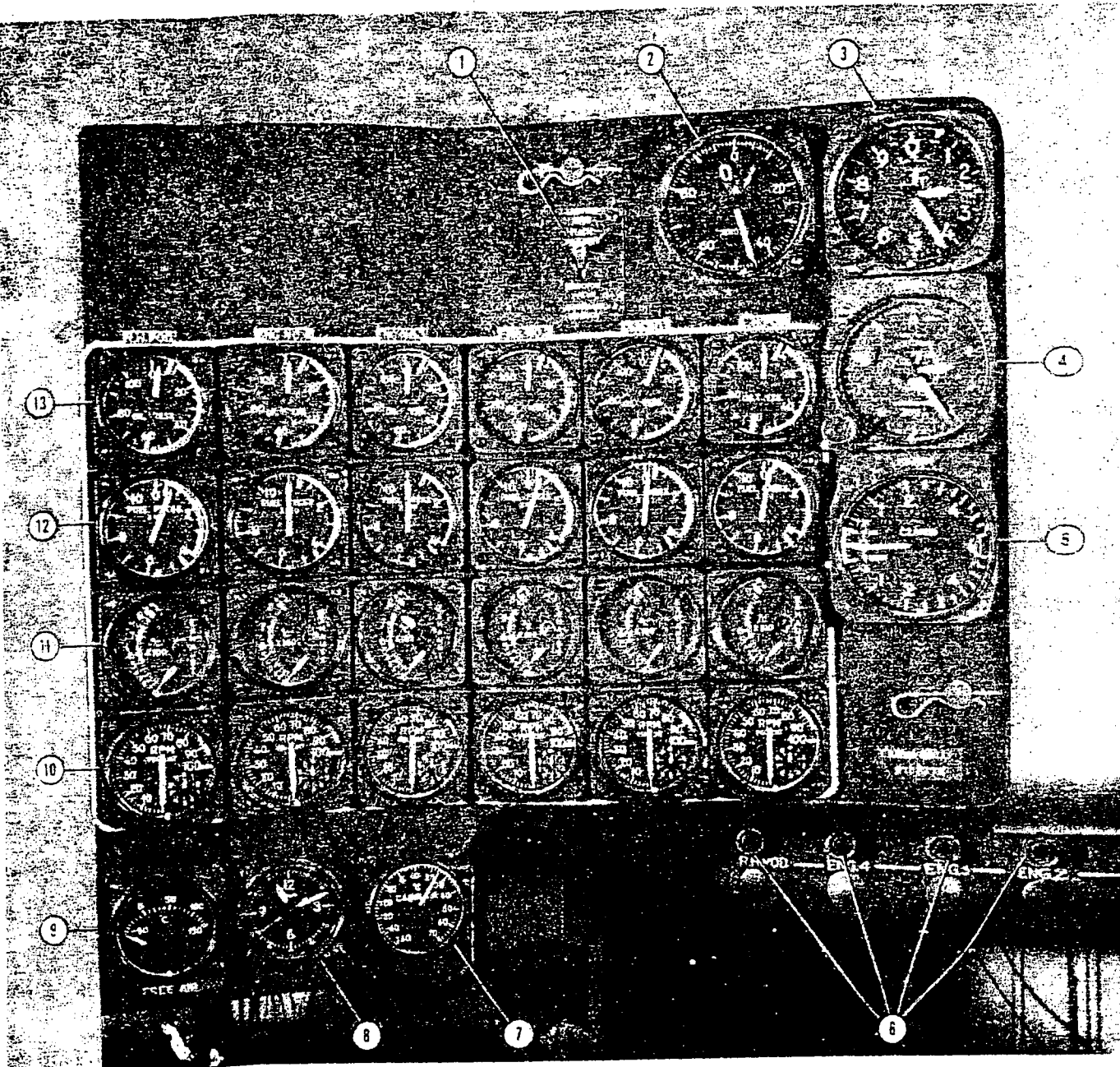

Figure 1-4 (Sheet 2 of 2 sheets). Engineer's Switch Panel



- |                                   |                                   |
|-----------------------------------|-----------------------------------|
| 1. STATIC PRESSURE SELECTOR VALVE | 7. CABIN AIR TEMPERATURE GAGE     |
| 2. AIRSPEED INDICATOR             | 8. CLOCK                          |
| 3. ALTIMETER                      | 9. FREE AIR TEMPERATURE GAGE      |
| 4. CABIN ALTIMETER                | 10. TACHOMETERS (6)               |
| 5. CABIN RATE OF CLIMB INDICATOR  | 11. EXHAUST TEMPERATURE GAGES (6) |
| 6. ENGINE OVERHEAT WARNING LIGHTS | 12. FUEL PRESSURE GAGES (6)       |
| 13. OIL PRESSURE GAGES (6)        |                                   |

TRASA 10023

Figure 1-5. Engineer's Center Instrument Panel

1-33. EXHAUST TEMPERATURE GAGES. Six exhaust temperature gages (11, figure 1-5), on the engineer's center instrument panel, are actuated by thermocouples located at points around the engine tailpipes.

1-34. TACHOMETERS. There are ten tachometers in the airplane. The engineer's center instrument panel has tachometers (10, figure 1-5) for all six engines, the pilot's instrument panel has tachometers (21, figure 1-19) for engines No. 1 and No. 4, and the copilot's panel has tachometers (8, figure 1-23) for engines No. 2 and No. 3. These indicators are electrically-actuated by tachometer-generators installed at the engines.

1-35. FUEL SYSTEM.

1-36. GENERAL.

1-37. The fuel system consists of six main tanks and six auxiliary tanks, a manifold line in each wing, supply lines from the main tanks and the manifold lines to the engines, supply lines from the auxiliary tanks to the manifold lines and from the manifold lines to the main tanks, a cross-feed line between the two manifolds, and the necessary control valves, booster pumps, and quantity gages. (See figure 1-6.) The main tanks feed the engines either directly or through the manifold lines; fuel from the auxiliary tanks can be fed to the engines through the main tanks or the manifold lines. Fuel may be transferred from one main

tank to another through the manifolds and the main tank filling lines. The cross-feed line passes through the crew nacelle; two cross-feed shut-off valves are installed in the line, one on each side of the airplane outboard of the crew nacelle, so that the section of the line within the crew nacelle is normally not under pressure. Overflow of the main tanks is prevented by fuel level valves which automatically close the main tank filling lines from the manifolds when the fuel in the main tanks reaches a predetermined level. The outboard main tanks, Nos. 1 and 4, are each equipped with two single-speed booster pumps; all other tanks are each equipped with one single-speed booster pump. Each booster pump has an output capacity exceeding the maximum fuel requirement of one engine. All pumps are equipped with check valves to prevent back flow of fuel into empty tanks.

1-38. FUEL SPECIFICATIONS.

1-39. JP-3 fuel, Specification AN-F-58 (MIL-F-5624), is normally used in this airplane. Gasoline, Specification AN-F-48 (MIL-F-5572), or JP-1 fuel, Specification AN-F-32 (MIL-F-5616), may be used as alternate fuels, but their use requires that the throttle stops be readjusted by the ground crew. Refer to paragraph 1-44 for fuel load restrictions for different types of fuel.

1-40. FUEL DATA TABLE.

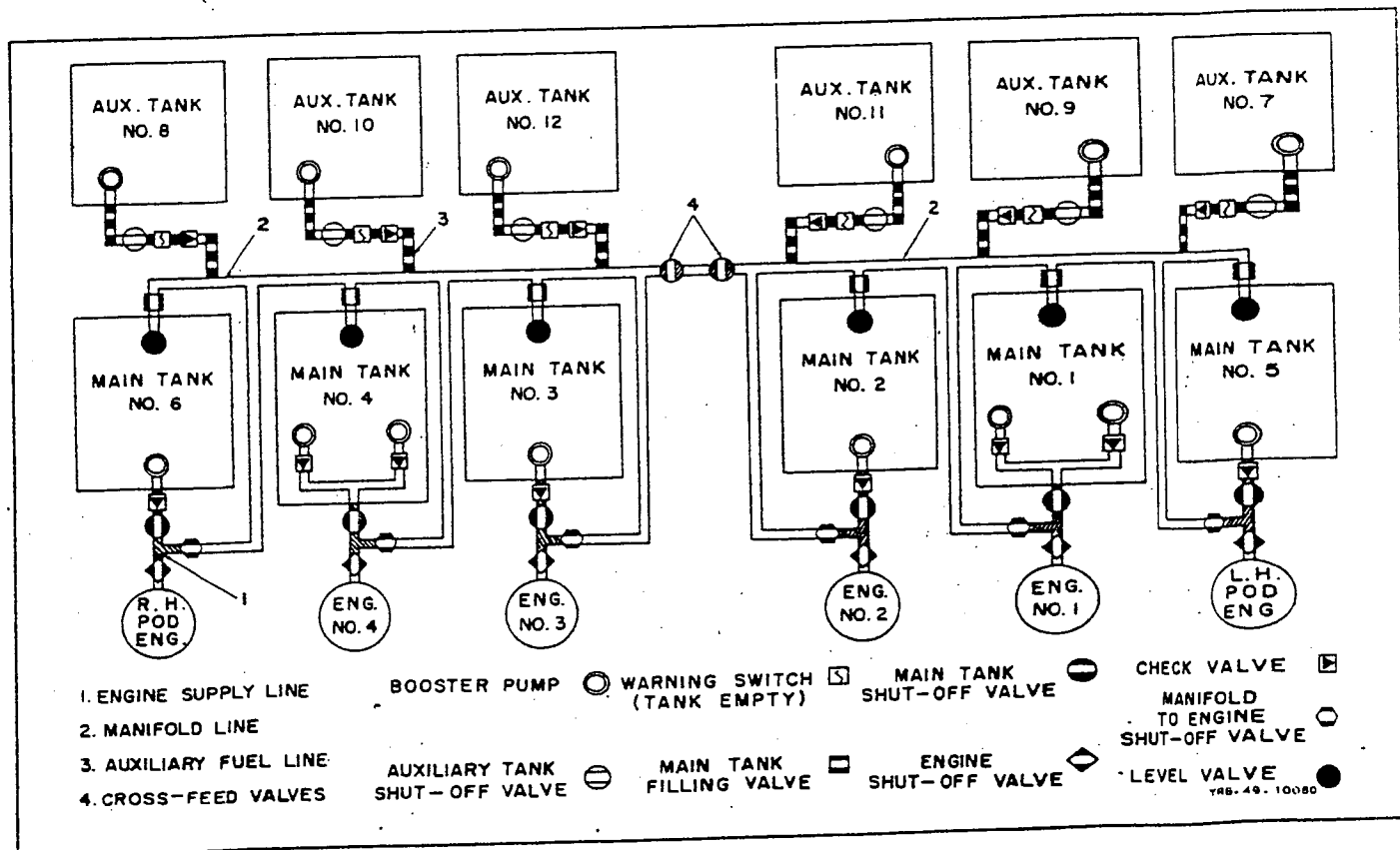

Figure 1-6. Fuel System

1-41. The following table lists the fuel quantity data for this airplane.

FUEL QUANTITY DATA (all figures are in U.S. gallons)					
Tanks	No. of Tanks	Useable Fuel (each)	Expansion Space (each)	Trapped Fuel Level Flight (each)	Total Volume (each)
Main #1 & #4	2	17	39	3	1304
Main #2	1	1282	40	3	1325
Main #3	1	1397	43	3	1443
Main #5 & #6	2	937.5	30	2.5	970
Auxiliary #7 & #8	2	1839* 1756** 1942***	167 246 60	4	2006
Auxiliary #9 & #10	2	1100* 1050** 1179***	115 165 36	3	1218
Auxiliary #11 & #12	2	937.5	30	2.5	970
TOTALS	12	14,831* 14,565** 15,195***	845 1103 473	36	15,704
* JP-3 Fuel ** JP-1 Fuel *** Gasoline					

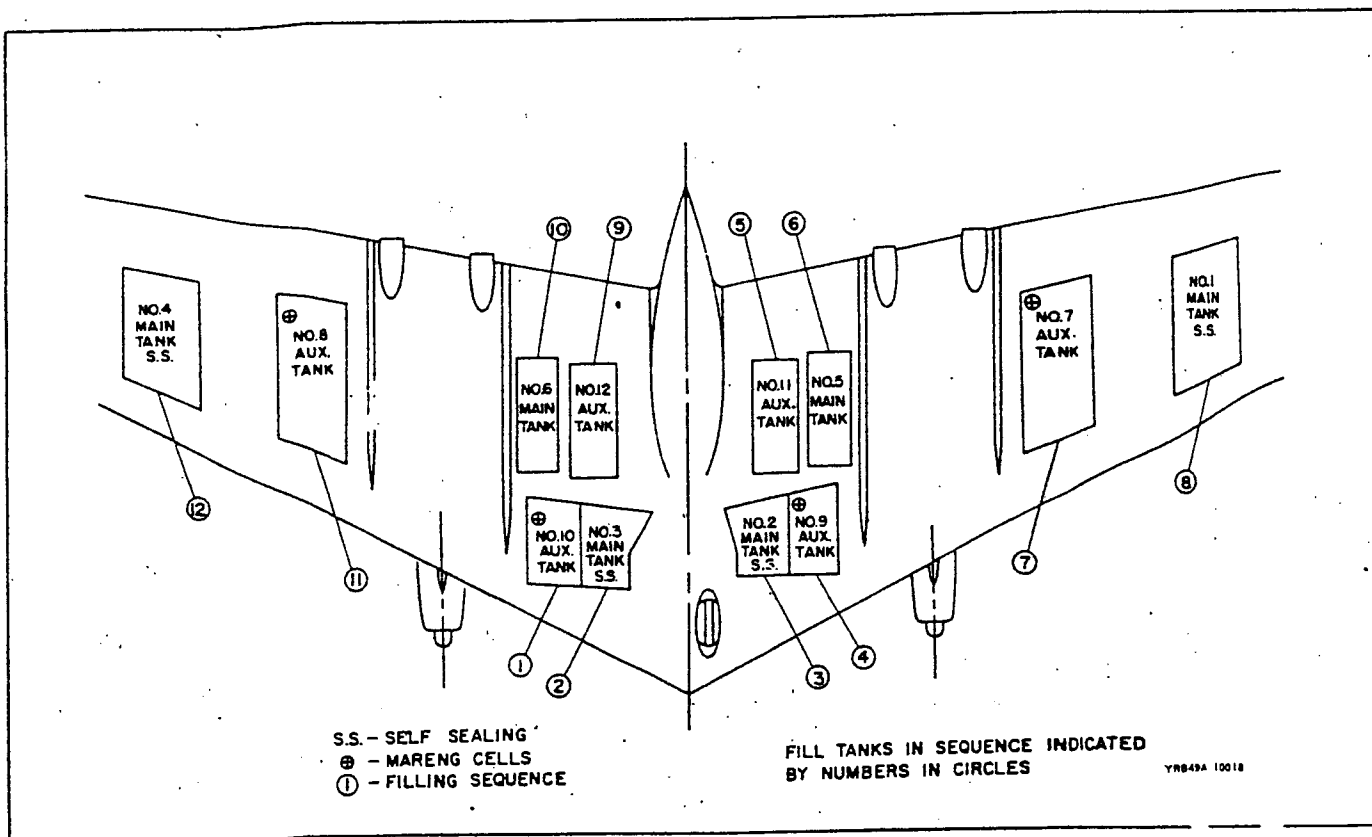

Figure 1-7. Fueling Procedure



42. FUEL LOADING.

1-43. DISTRIBUTION OF FUEL LOAD. (See figure 1-7.) The design of this airplane is such that the center of gravity location, both longitudinally and laterally, is critically affected by the distribution of the fuel load in the tanks. In order to keep the center of gravity as far forward as possible while the airplane is on the ground, thus preventing inadvertent upset, and to control the span-wise location of the center of gravity, the following procedures are followed in fueling the airplane:

a. The tanks are filled in the sequence shown in figure 1-7. If all tanks are not to be filled, the same sequence is followed, skipping the tanks that are to remain empty. (Tank draining sequence, on the ground, is the reverse of that shown in figure 1-7.)

b. Tanks No. 7 and No. 8 are not filled to more than one-half capacity unless the amount over one-half capacity is also carried in either auxiliary tanks No. 9 and No. 10 or auxiliary tanks No. 11 and No. 12.

1-44. RESTRICTIONS ON FUEL LOAD. (See figure 1-7.) Tanks Nos. 1, 2, 3, and 4, which are self-sealing, and tanks Nos. 5, 6, 11, and 12 are designed for the heavier types of fuel (JP-1 and JP-3) and can be filled to capacity with any type fuel. Tanks Nos. 7, 8, 9, and 10, which are not self-sealing, are designed for gasoline weighing 6 pounds per U.S. gallon. When fuel other than gasoline is used, the amount of fuel in tanks Nos. 7, 8, 9, and 10 shall be reduced so that the weight does not exceed the value prevailing when the tanks are full of gasoline. The maximum permissible quantities of alternate fuel for these four tanks are shown in paragraph 1-41.

1-45. FUEL SYSTEM CONTROLS.

1-46. FUEL SELECTOR SWITCHES. Fuel flow to the engines is controlled by the operation of six rotary-type, five-position, fuel selector switches (2, figure 1-8) on the engineer's fuel system control panel. The fuel selector switches control the engine shut-off valves, fuel manifold valves, main tank outlet valves, and the main tank booster pumps, as shown in the following table:

FUEL SELECTOR SWITCH FUNCTIONS				
Fuel Selector Switch Position	Engine Shut-Off Valve	Manifold Valve	Main Tank Valve	Main Tank Booster Pump
"OFF"	Closed	Closed	Closed	Off
"NORMAL TANK TO ENG."	Open	Closed	Open	On
"TANK TO MAN. & ENG."	Open	Open	Open	On
"TANK TO MAN."	Closed	Open	Open	On
"MAN. TO ENG."	Open	Open	Closed	Off

The electrical circuits for operation of the fuel booster pumps and shut-off valves are controlled by circuit breaker switches (34 and 33, figure 1-4) on the engineer's switch panel.

1-47. FILL-TANK SWITCHES. Six fill-tank switches (3, figure 1-8) are located on the engineer's fuel system control panel. When one of the fill-tank switches is placed in the "ON" position, the fill valve at that main tank is opened, allowing fuel to flow from the manifold into the main tank. When the switches are in the "OFF" positions, the main tank fill valves are closed. The electrical circuits for operation of the main tank fill valves are controlled by circuit breaker switches (6, figure 1-4) on the engineer's switch panel.

1-48. AUXILIARY-TO-MANIFOLD SWITCHES. Six auxiliary-to-manifold switches (4, figure 1-8) on the engineer's fuel system control panel control the flow of fuel from the auxiliary tanks to the fuel manifolds. When one of these switches is placed in the "ON" position, the corresponding auxiliary-to-manifold valve is opened and the tank booster pump is energized. With the switches in the "OFF" positions, the auxiliary-to-manifold valves are closed and the auxiliary tank booster pumps are inoperative. The electrical circuits for operation of the auxiliary-to-manifold valves and auxiliary tank booster pumps are controlled by circuit breaker switches (5 and 34, figure 1-4) on the engineer's switch panel.

1-49. CROSS-FEED SWITCH. When the cross-feed switch (7, figure 1-8), on the engineer's fuel system control panel, is in the "OFF" position, both of the cross-feed shut-off valves, outboard of the crew nacelle in each wing, are closed. When the switch is placed in the "ON" position, both cross-feed valves are opened and the two manifold lines are connected through the cross-feed line. The electrical circuit for operation of the cross-feed valves is controlled by a circuit breaker switch (7, figure 1-4) on the engineer's switch panel.

1-50. FUEL SYSTEM INDICATORS.

1-51. FUEL LEVEL GAGES. Six dual-type fuel level gages (6, figure 1-8) on the engineer's fuel system control panel register the fuel quantities in the main and auxiliary fuel tanks.

They are calibrated in U.S. gallons.

1-52. **AUXILIARY TANK EMPTY WARNING LIGHTS.** A pressure switch is installed in the fuel supply line from each auxiliary tank. When an auxiliary-to-manifold switch is "ON" and the tank becomes empty, absence of fuel pressure in the line causes the pressure switch to close, lighting the auxiliary tank empty warning light (5, figure 1-8) on the fuel system control panel as an indication to the engineer that the auxiliary-to-manifold switch should be turned "OFF" and fuel selection changed as necessary.

1-53. **FUEL COUNTER INDICATORS.** Six subtrac-

tive-type fuel counter indicators (1, figure 1-8), one for each engine, are provided on the fuel system control panel. The counters are electrically-actuated by the operation of flowmeters at the engines. Each counter indicates, subtractively, the rate of fuel consumption of the related engine. Maximum setting for each counter is 999. The electrical circuit for the fuel counter indicators is controlled by a circuit breaker switch (11, figure 1-4) on the engineer's switch panel.

1-54. ELECTRICAL SYSTEMS.

1-55. GENERAL.

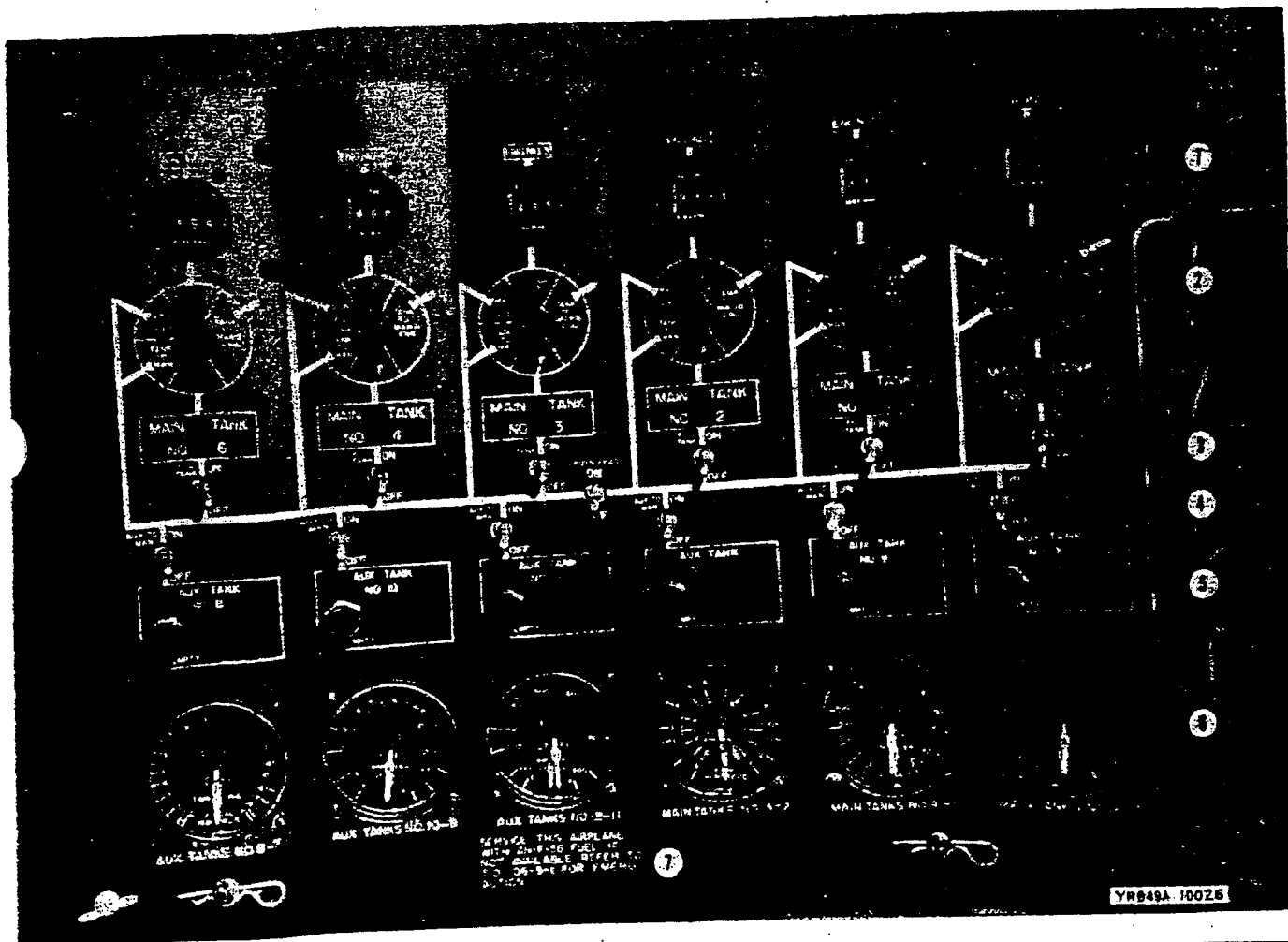

- |                                       |  |
|---------------------------------------|--|
| 1. FUEL COUNTER INDICATORS (6)        | 5. AUXILIARY TANK EMPTY WARNING LIGHTS (6) |
| 2. FUEL SELECTOR SWITCHES (6)         | 6. FUEL LEVEL GAGES                        |
| 3. FILL TANK SWITCHES (6)             | 7. CROSSFEED SWITCH (1)                    |
| 4. AUXILIARY TO MANIFOLD SWITCHES (6) |  |

Figure 1-8. Fuel System Control Panel

1-56. The airplane utilizes both alternating and direct current. Engine-driven alternators and generators provide the ac and dc power when the engines are operating. External power receptacles and circuits are provided for engine starting and for ground operation of the ac and dc systems when the engines are not running.

#### 1-57. EXTERNAL POWER SYSTEMS.

1-58. There are four external power systems: a 28-volt, dc system to operate the external ac-power relay controls; a 208-volt, 3-phase, 400-cycle, ac system for the airplane's ac power; and two separate 28-volt dc engine-starting systems, one for the engines in the left-hand wing, and one for the engines in the right-hand wing.

#### 1-59. AIRPLANE EXTERNAL DC POWER SYSTEM.

1-60. An airplane external dc power receptacle (11, figure 1-2) for connecting an external power source to the airplane's 28-volt dc system is located under a hinged cover in the lower surface of the left wing, just aft of the photoflash bomb bay. It is necessary to have external dc power plugged into this receptacle before external ac power can be supplied to the airplane's equipment.

#### 1-61. AIRPLANE EXTERNAL AC POWER SYSTEM.

1-62. An airplane external ac power receptacle (11, figure 1-2) for connecting an external power source to the airplane's 208-volt ac system is located beside the airplane external dc power receptacle under the hinged cover in the lower surface of the left wing. After external ac power has been plugged into the airplane external ac power receptacle, the voltage, frequency, and phase sequence of the power must be checked by means of test switches and indicators on the engineer's ac electrical control panel. If the voltage, frequency, and phase sequence of the external ac power are correct, the external ac power circuit is then connected to the airplane's ac system by the operation of an external ac power breaker switch on the engineer's ac electrical control panel. External dc power must be connected to the airplane before the external ac circuit can be connected to the airplane's ac system.

1-63. EXTERNAL AC POWER VOLTAGE AND FREQUENCY TEST SWITCHES. The external ac power voltage and frequency test switches (1, figure 1-9), connected by a bar, are spring-loaded to a neutral position. When the switches are held to the "TEST" position, with the voltage-frequency selector switch (7, figure 1-9) in the "EXTERNAL POWER ON" position, the voltage and frequency of the external ac power are indicated on the ac voltmeter (17, figure 1-9) and the ac cycles indicator (16, figure 1-9) on the engineer's ac electrical control panel.

1-64. EXTERNAL AC POWER PHASE SEQUENCE INDICATION. When external ac power is plugged in, the phase sequence indicator (14, figure 1-9) on the ac electrical control panel must be checked to determine that the external power has the correct phase sequence before the power is connected into the airplane's system. If the phase sequence is correct, the light marked

"1-2-3 CORRECT" on the phase sequence indicator illuminates. If the phase sequence is incorrect, the light marked "3-2-1 REVERSED" on the phase sequence indicator illuminates, and the ground crew must be notified to check and correct the wiring at the external power source.

1-65. EXTERNAL AC POWER BREAKER SWITCH AND INDICATOR LIGHT. An external ac power breaker switch (3, figure 1-9), on the ac electrical control panel, controls the dc-operated external ac power connection. Tripping this switch to the "CLOSE" position, with external dc power on the airplane, closes the relay which completes the external ac power circuit to an ac bus in the crew nacelle. When the circuit is closed, the external power on indicator light (4, figure 1-9) on the panel lights. Moving the breaker switch to the "OPEN" position opens the circuit, and the light goes out.

#### 1-66. ENGINE STARTING EXTERNAL DC POWER SYSTEMS.

1-67. Two separate external dc power systems are provided as the only means of operating the engine starters. Two external power receptacles (12, figure 1-2) on each side of the airplane, located just inboard of the pod engines and forward of the internal engines, are provided for connecting an external dc power source to the engine starting circuits. Each pair of receptacles is bussed together. When starting the engines, a Type C-16 power unit and two 12-volt, jet-type batteries must be plugged into the engine-starting circuit on each side of the airplane. The batteries must be connected together in series and in parallel with the two motor-generators contained in the Type C-16 unit. The two power cables from the unit must be plugged into the two receptacles on either side of the airplane.

#### 1-68. ALTERNATING CURRENT POWER SYSTEM.

1-69. Each external pod engine drives a 40-KVA, 208-volt, 3-phase, 400-cycle alternator through a constant-speed drive assembly. Alternator No. 1 is driven by the left-hand pod engine, No. 2 by the right-hand pod engine. Each alternator feeds current into a separate bus in the crew nacelle. Power is distributed from the busses to sectionalizing panels throughout the airplane, and take-offs from these panels supply the various motors and actuators with ac power. Alternating current is also routed from one bus to a transformer panel, where it is stepped down to operate such equipment as the gyro compass and the suit heaters. A bus-tie is provided to connect the two busses together for parallel operation of the alternators or for operation of all ac equipment from one alternator. A single panel (see figure 1-9) at the engineer's station incorporates all of the controls for the ac system. AC circuits are protected from overloads by limiter-type fuses. The limiter-type fuse permits temporary overloads in a circuit without blowing out. The time required for a limiter to blow out is inversely proportional to the amount of the overload. The locations of limiters that are accessible in flight are shown in figure 1-10. Spare limiters are carried in a stowage bag located in the aft crew nacelle section.

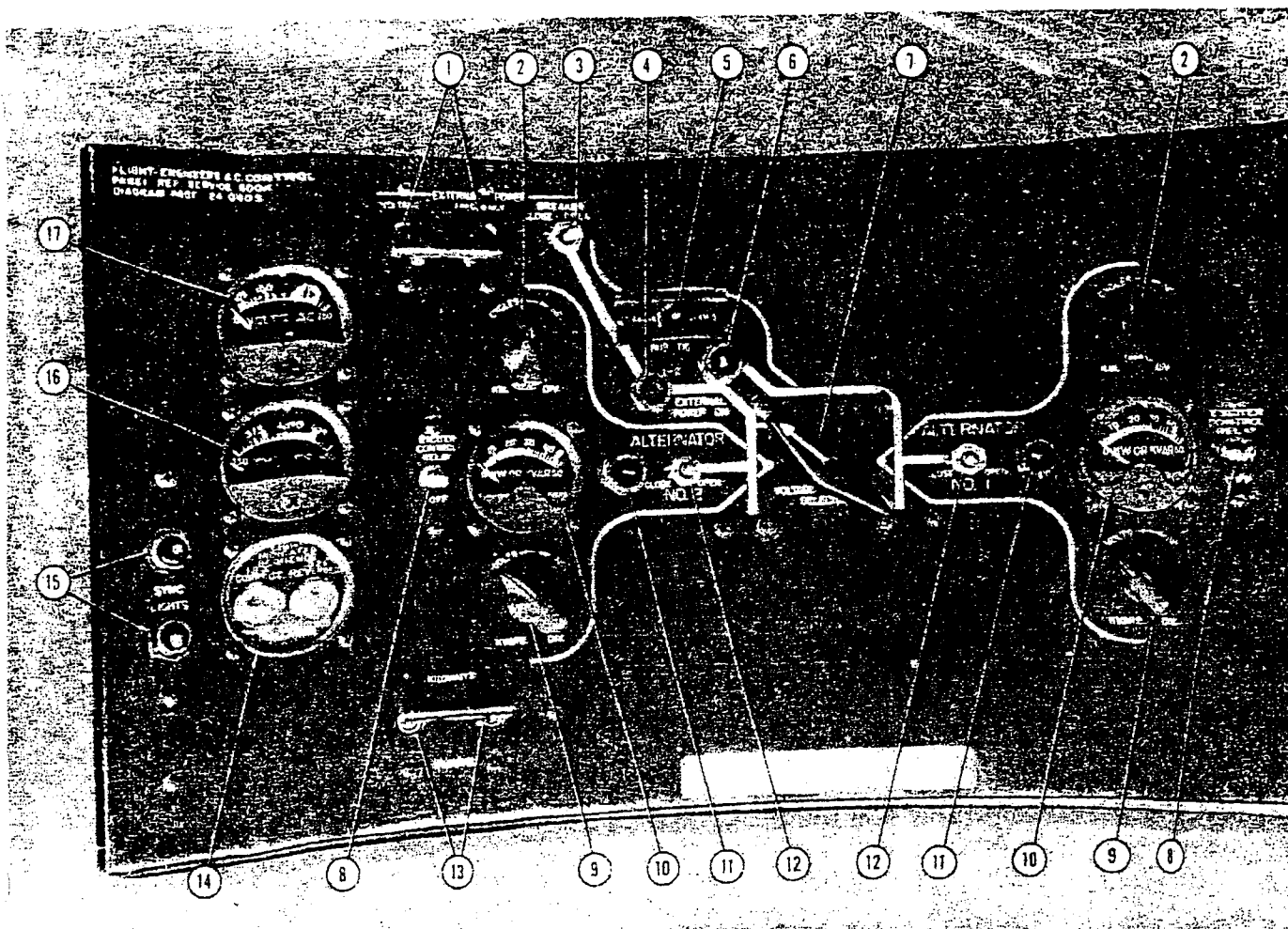

- |   |  |
|---|--|
| 1. EXTERNAL A C POWER VOLTAGE AND FREQUENCY TEST SWITCHES | 9. ALTERNATOR VOLTS CONTROL SWITCH         |
| 2. ALTERNATOR CYCLES CONTROL RHEOSTAT                     | 10. KILOWATTS-KILOVARS INDICATOR           |
| 3. EXTERNAL A C POWER BREAKER SWITCH                      | 11. ALTERNATOR SWITCH INDICATOR LIGHT      |
| 4. EXTERNAL POWER-ON INDICATOR LIGHT                      | 12. ALTERNATOR BREAKER SWITCH              |
| 5. BUS TIE BREAKER SWITCH                                 | 13. KILOWATTS - KILOVARS SELECTOR SWITCHES |
| 6. BUS TIE INDICATOR LIGHT                                | 14. PHASE SEQUENCE INDICATOR               |
| 7. VOLTAGE-FREQUENCY SELECTOR SWITCH                      | 15. ALTERNATOR SYNCHRONIZING LIGHTS        |
| 8. EXCITER CONTROL RELAY SWITCH                           | 16. A C CYCLES INDICATOR                   |
|   | 17. A C VOLTMETER                          |

TRASA 10027

Figure 1-9. AC Electrical Control Panel

1-70. AC POWER SYSTEM CONTROLS.

1-71. ALTERNATOR BREAKER SWITCHES AND INDICATOR LIGHTS. There are two alternator breaker switches (12, figure 1-9), one for each alternator. Moving one of these switches to the "CLOSE" or "OPEN" position connects or breaks the corresponding alternator circuit to its bus. An alternator switch indicator light (11, figure 1-9) for each alternator illuminates when the circuit from the alternator to the bus is closed.

1-72. VOLTAGE-FREQUENCY SELECTOR SWITCH. The voltage-frequency selector switch (7, figure 1-9) is used to select individual alternators or the bus of both so that their individual or combined outputs may be read on the ac voltmeter and cycles indicator.

1-73. ALTERNATOR EXCITER CONTROL RELAY SWITCHES. The power output of an alternator is dependent upon its field being excited by direct current which is supplied by a dc generator built into the alternator. The exciter current for each alternator is turned on and off by the corresponding exciter control relay switch (8, figure 1-9); tripping a switch to one position or the other closes or opens the circuit to control the flow of exciter current to the alternator.

1-74. ALTERNATOR CYCLES CONTROL RHEOSTATS. Each of the two cycles control rheostats (2, figure 1-9) controls the governor circuit that

maintains the corresponding alternator at a constant speed, as selected. The speed, and consequently the cycles (frequency), of each alternator is regulated by adjustment of the corresponding rheostat.

1-75. ALTERNATOR VOLTS CONTROL RHEOSTATS. The alternator volts control rheostats (9, figure 1-9) provide means of adjusting the voltages of the alternators by regulating the exciter field currents.

1-76. KILOWATTS-KILOVARS SELECTOR SWITCHES. The kilowatts-kilovars selector switches (13, figure 1-9), connected by a bar, are used during the alternator paralleling procedure so that the alternator loads may be determined, as indicated on the kilowatts-kilovars indicators.

1-77. BUS TIE BREAKER SWITCH AND INDICATOR LIGHT. The bus tie breaker switch (5, figure 1-9) is operated to connect the busses of both alternators for parallel operation or for operation of all ac equipment from one alternator. The bus tie indicator light (6, figure 1-9) illuminates when the bus tie breaker switch is closed.

1-78. AC POWER SYSTEM INDICATORS.

1-79. AC VOLTMETER. A single ac voltmeter (17, figure 1-9) shows the voltage of the individual or combined alternator currents, as determined by the setting of the voltage-frequency

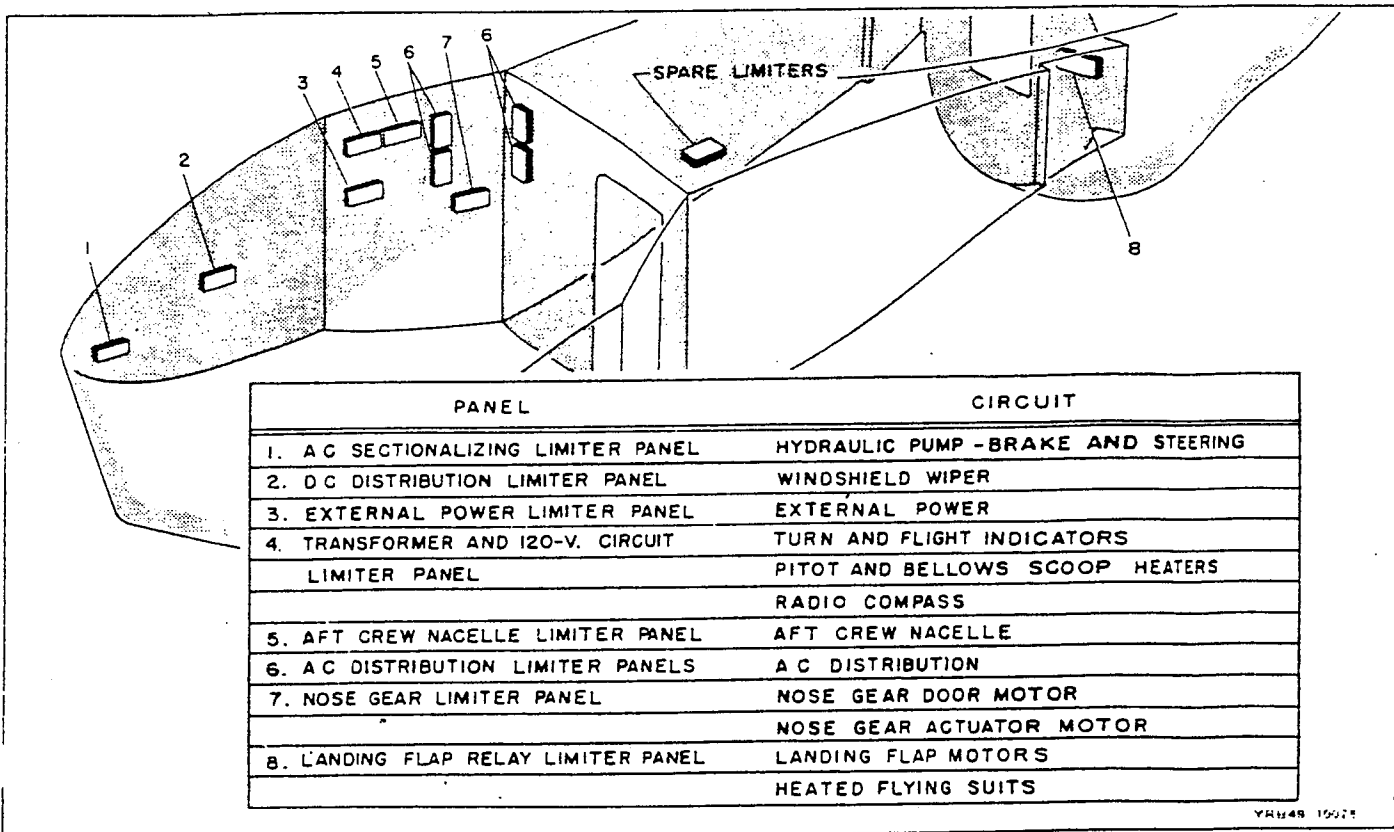

Figure 1-10. Locations of Electrical Limiters

selector switch. This voltmeter also shows the voltage of the external ac power supply when the external power voltage and frequency test switches are moved to the "TEST" position.

1-80. AC CYCLES INDICATOR. One cycles indicator (16, figure 1-9) is provided for use with both alternators. When the voltage-frequency selector switch is turned to either of the individual alternator positions or to the combined bus position, the cycles of the individual or combined alternator output may be read on the indicator. The indicator also registers the cycles of the external power supply when the external power voltage and frequency test switches are placed in the "TEST" position.

1-81. ALTERNATOR SYNCHRONIZING LIGHTS. Two alternator synchronizing lights (15, figure 1-9) are provided to indicate unsynchronized operation of the alternators during the paralleling procedure. When the lights are on, the voltages of the two alternators are unequal; when they are flickering, the cycles are not the same. When the voltages and cycles of both alternators are the same, the lights are off.

1-82. KILOWATTS-KILOVARS INDICATORS. One kilowatts-kilovars indicator (10, figure 1-9) is provided for each alternator to show the amount of power being used. The desired power reading may be selected by operation of the kilowatts-kilovars selector switches. A kilowatts reading indicates the useful load output of an alternator; a kilovars reading indicates the reactive component of the alternator.

1-83. DIRECT CURRENT POWER SYSTEM.

1-84. Direct current power is supplied by six engine-driven, 28-volt, 400-ampere starter-generators and one 24-volt, 35-ampere-hour battery. Each generator circuit has an over-voltage and undervoltage cut-out to prevent the generator becoming overloaded when it is being operated in parallel. The airplane battery, located in the nose wheel well, is not intended for continuous use in the operation of dc equipment. Whenever possible, an external dc power source shall be used for operation of dc equipment when the engines are not operating. For normal operation, the battery is connected into the dc power system so that the generators maintain the battery charge. An ac-operated heater is provided for the battery. Direct current circuits are protected by circuit breakers and limiters. Limiters that are accessible in flight are shown in figure 1-10. Spare limiters are carried in a stowage bag located in the aft crew nacelle section.

1-85. DC POWER SYSTEM CONTROLS.

1-86. With the exception of the battery switch and the battery heater switch, the dc power system controls are all located on the dc electrical control panel (3, figure 1-3, and figure 1-11) above the engineer's switch panel.

1-87. GENERATOR CONTROL SWITCHES. A three-position generator control switch is provided for each generator. The switches have "ON," "OFF," and "RESET" positions. The "RESET" position is used to reset the cut-out should an overvoltage or undervoltage condition cut

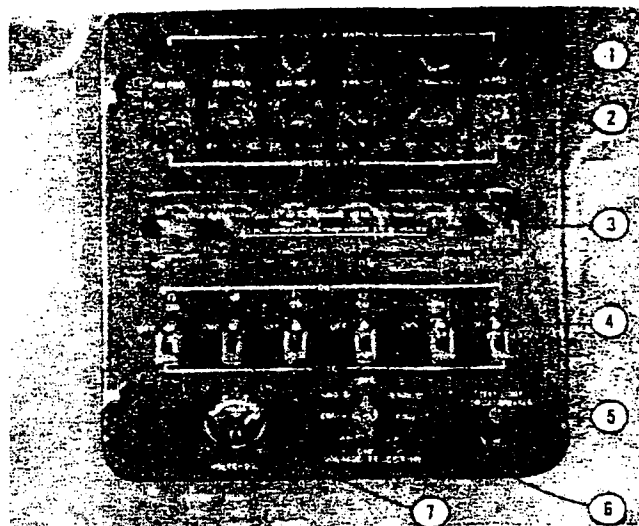

1. OVERVOLTAGE WARNING LIGHTS (6)
2. GENERATOR AMMETERS (6)
3. VOLTAGE REGULATOR RHEOSTATS (6)
4. GENERATOR CONTROL SWITCHES (6)
5. OVERVOLTAGE TEST LIGHT CIRCUIT BREAKER
6. GENERATOR VOLTAGE SELECTOR SWITCH
7. VOLTMETER

Figure 1-11. DC Electrical Control Panel

a generator out of the system. The voltage of a generator that has been cut out must be corrected by adjusting the corresponding voltage regulator rheostat before the generator can be reset to stay on the line.

1-88. GENERATOR VOLTAGE REGULATOR RHEOSTATS. A generator voltage regulator rheostat (3, figure 1-11) is provided for adjusting the voltage of each starter-generator. The rheostats are located under the hinged, transparent cover on the dc electrical control panel.

1-89. GENERATOR VOLTAGE SELECTOR SWITCH. A multiple-position generator voltage selector switch (6, figure 1-11) provides means of taking individual generator or bus voltage readings on the single voltmeter.

1-90. BATTERY SWITCH. The battery switch (24, figure 1-4), with "ON" and "OFF" positions, is located at the bottom of the engineer's switch panel. A guard protects the switch from being inadvertently turned on or off.

1-91. BATTERY HEATER SWITCH. A two-position, battery heater circuit breaker switch (13, figure 1-4), located on the engineer's switch panel, controls the flow of alternating current to the battery heater.

1-92. DC POWER SYSTEM INDICATORS.

1-93. GENERATOR AMMETERS. One ammeter (2, figure 1-11) for each generator indicates what percent of the rated load capacity of the

generator is being drawn from the generator. The ammeters are located at the top of the dc electrical control panel.

1-94. DC VOLTMETER. A voltmeter (7, figure 1-11) at the bottom of the dc electrical control panel indicates the voltage of the generator selected by the voltage selector switch.

1-95. GENERATOR OVERVOLTAGE WARNING LIGHTS AND CIRCUIT BREAKER. A red overvoltage warning light (1, figure 1-11) for each generator, at the top of the dc control panel, lights when a generator is cut out of the system because of overvoltage. A circuit breaker (5, figure 1-11) protecting the warning lights circuit is installed in the lower right-hand corner of the dc electrical control panel.

1-96. HYDRAULIC SYSTEMS.

1-97. GENERAL.

1-98. The airplane is equipped with two separate and independent normal hydraulic systems, the power surface control system and the brakes and steering system. In addition, two emergency elevon and trim flap systems, left-hand and right-hand, are provided.

1-99. POWER SURFACE CONTROL HYDRAULIC SYSTEMS.

1-100. The power surface control system comprises four sub-systems, two on each side of the airplane. Each of the four independent sub-systems has its own hydraulic fluid reservoir and receives its pressure from two hydraulic pumps driven by the corresponding internal

engine. The power surface control systems actuate the elevons, rudders, and trim flaps, in response to control stick, trim wheel, and pedal movements. The wing slot doors are also actuated by hydraulic power from these systems. There are no controls for the power surface control systems, their operation being entirely automatic. When the internal engines are running at 57% rpm or more, the engine-driven hydraulic pumps of the power surface control hydraulic system supply hydraulic pressure sufficient to actuate all control surfaces and the wing slot doors simultaneously at their maximum operating speeds. When the internal engine rpm drops below 57%, the hydraulic pressure is reduced proportionately. Therefore, the minimum flight idling speed for the internal engines is 57% rpm.

1-101. POWER SURFACE CONTROL SYSTEMS PRESSURE GAGES. Eight hydraulic pressure gages (4, figure 1-12), one for each engine-driven hydraulic pump, are located on a panel below the engineer's fuel system control panel.

1-102. EMERGENCY ELEVON AND TRIM FLAP HYDRAULIC SYSTEMS.

1-103. Two emergency elevon and trim flap hydraulic systems, one in each wing, are provided. These emergency systems supply hydraulic pressure from 24-volt dc motor-driven hydraulic pumps, one in each outboard wing, to one of the two actuating cylinders of each elevon and trim flap. If the hydraulic pressure in the power surface control systems is insufficient to provide maximum speed of control surface movement, the emergency elevon and trim flap hydraulic systems can be operated to augment the hydraulic power available for control surface movement. In the event of complete failure of all four power surface control systems, the emergency elevon and trim flap systems can be operated to supply power for partial operation of the elevons and trim flaps only. The emergency system pump motors are driven by power from the airplane battery; therefore, the emergency systems are operated only for brief periods, under emergency conditions. Control switches for the emergency elevon and trim flap systems are provided for both pilots on the control stick grips.

1-104. BRAKES AND STEERING HYDRAULIC SYSTEM.

1-105. An ac motor-driven pump supplies hydraulic pressure for operation of the main wheel brakes and the nose wheel steering unit. This system also supplies pressure for operation of the pilot's windshield wiper. Normal operation of the brakes and steering hydraulic system is automatically controlled by a landing gear-actuated switch. The system is inactive when the gear is up. However, the pump can be started at any time by means of an override switch at the engineer's station. A push-to-reset type circuit breaker (45, figure 1-20) for the brakes and steering system electrical circuit is located on the pilot's pedestal.

1-106. HYDRAULIC BRAKE PUMP MANUAL OVERRIDE SWITCH. The hydraulic brake pump manual override switch (1, figure 1-12), located on the engineer's hydraulic pressure gage panel, provides emergency means of starting the electric pump of the brakes and steering system. It

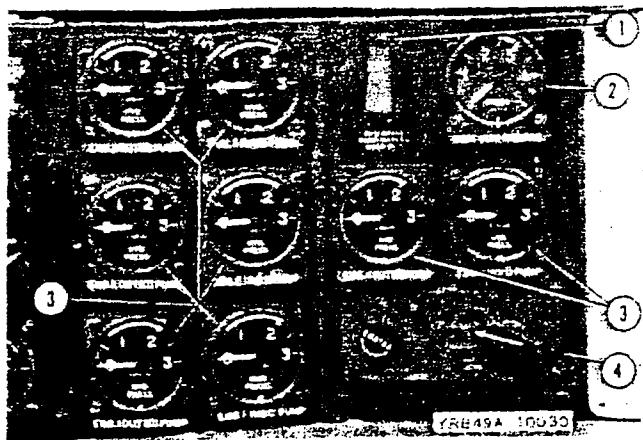

1. HYDRAULIC BRAKE PUMP MANUAL  
OVERRIDE SWITCH
2. NOSE GEAR STEERING SYSTEM  
PRESSURE GAGE
3. POWER SURFACE CONTROL  
SYSTEM PRESSURE GAGES (8)
4. INTERPHONE CONTROL PANEL

Figure 1-12. Hydraulic Pressure Gage Panel

can be used to test the operation of the brakes and steering hydraulic system pump in flight or to start the pump in an emergency when the system will not operate normally because of emergency lowering of the landing gear, failure of the normal operating limit switches on the gear units, or failure of the normal control circuit. Electrical power for the hydraulic brake pump manual override switch circuit is controlled by a circuit breaker switch (31, figure 1-4) on the engineer's switch panel.

1-107. NOSE GEAR STEERING HYDRAULIC PRESSURE GAGE. A nose gear steering hydraulic pressure gage (2, figure 1-12), on the engineer's hydraulic pressure gage panel, registers the pressure in the brakes and steering hydraulic system. It does not indicate the pressure delivered to the nose gear steering unit; a restrictor in the supply line reduces the pressure delivered to that unit.

1-108. BRAKES AND STEERING SYSTEM ACCUMULATOR AIR PRESSURE GAGE. An air pressure gage for the brakes and steering system accumulator is located just forward of the pilot's instrument panel. The gage may be read from a position to the right of the pilot's pedestal.

1-109. FLIGHT CONTROL SYSTEMS.

1-110. GENERAL.

1-111. The flight control systems include the control systems for the following components:

elevons, rudders, trim flaps, landing flaps, wing slot doors, and automatic pilot. Artificial "feel" is provided for the surface controls. There are no control surface locks; the hydraulic fluid in the control surface actuating cylinders provides a fluid lock which prevents the surfaces from moving when the airplane is not in use.

1-112. ELEVONS.

1-113. The elevons function both as elevators and as ailerons; they can be operated up and down together and/or in opposite directions to provide elevator or aileron control or a combination of both. (See figure 1-14.)

1-114. ELEVON CONTROL SYSTEM.

1-115. The elevons are each actuated by two hydraulic cylinders, inboard and outboard, which normally obtain operating pressure from the inboard and outboard power surface control hydraulic systems, respectively, on each side of the airplane. Hydraulic pressure to the actuating cylinders is regulated by servo-valves that are operated through cable systems by the control sticks. In the event of failure in the power surface control hydraulic systems, the outboard actuating cylinder of each elevon can be supplied with hydraulic pressure by the corresponding emergency elevon and trim flap hydraulic systems, allowing partial operation of the elevons.

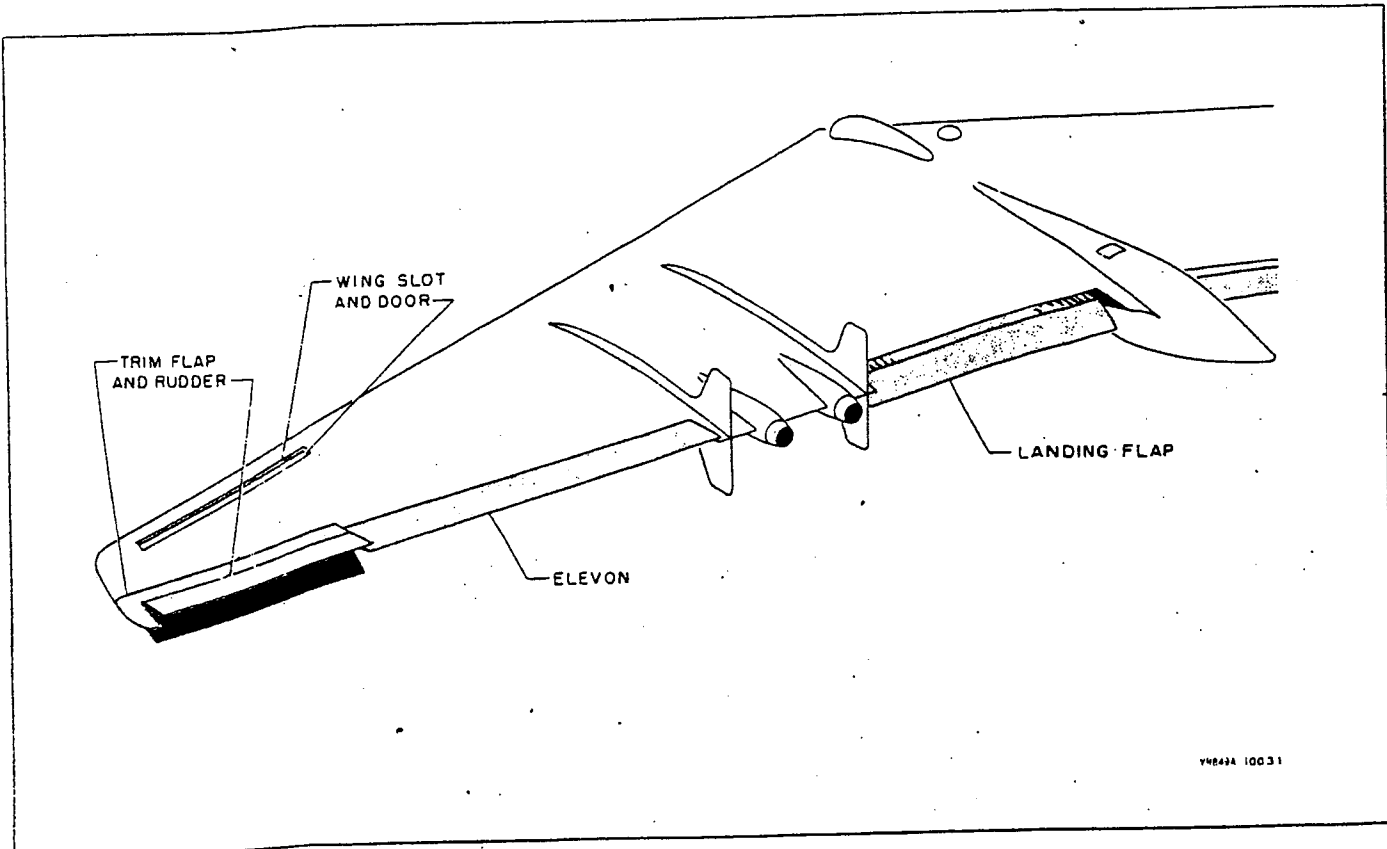

Figure 1-13. Flight Control Surfaces



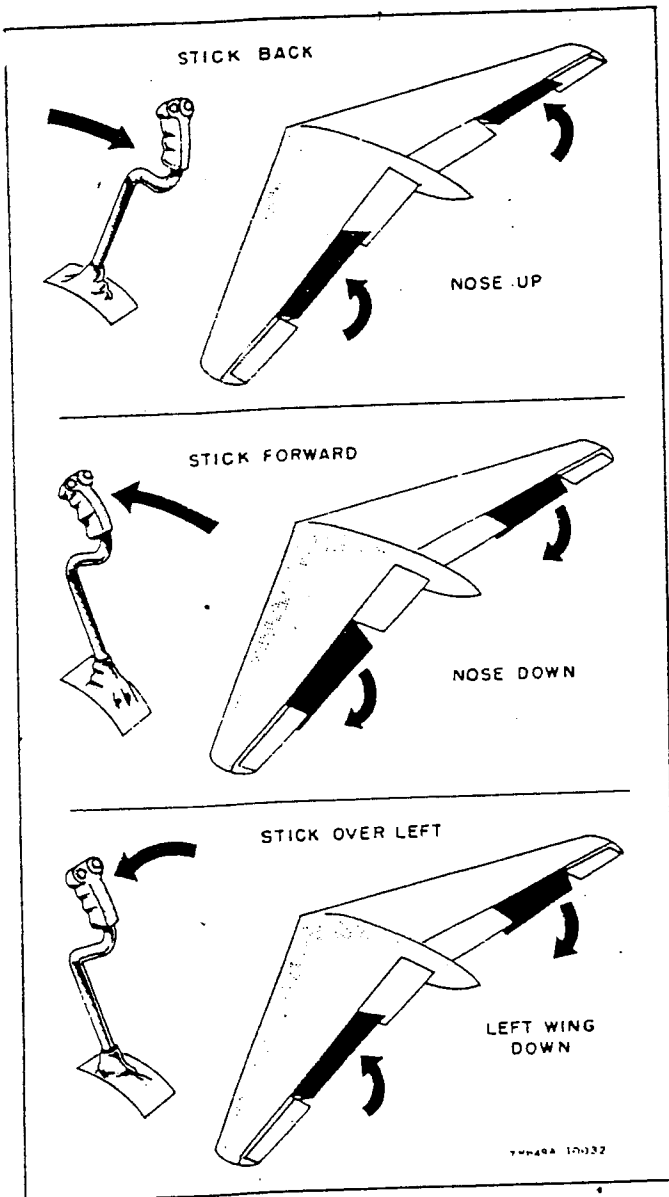

Figure 1-14. Elevon Action

1-116. **ELEVON CONTROL STICKS.** Two interconnected control sticks are provided for the pilot and the copilot. Conventional movements of either control stick produce elevon action corresponding to conventional elevator and aileron action. Control stick "feel" is produced by springs attached to the stick mechanisms laterally and, in flight, by ram air pressure in a bellows connected to the pilot's stick longitudinally. Elevator control force, as a function of normal acceleration, is supplied by a bob-weight attached to the copilot's stick.

1-117. **ELEVON CONTROL SYSTEM FORCE BELLOWES.** The force bellows (see figure 1-15) connected to the pilot's control stick provides "elevator" control "feel." The bellows is divided into two halves by a diaphragm to which is connected the linkage from the control stick. The chamber on the forward side of the diaphragm is open to static air pressure and the

chamber on the aft side of the diaphragm is supplied with ram air pressure from an air scoop. When the airplane is at rest on the ground, static air pressure exists in both halves of the bellows and there is no resistance to longitudinal movement of the control stick and the connected diaphragm. In flight, ram air pressure on the aft side of the diaphragm resists movement of the diaphragm and provides "feel" for "elevator" movement of the control sticks. Resistance to movement of the diaphragm and the control sticks is proportional to the airspeed of the airplane.

1-118. **RUDDERS.**

1-119. The split-type rudders are hinged to and form the trailing edges of the trim flaps. The individual rudders operate (1) with the trim flaps for pitch and roll trim, (2) independently of the trim flaps and each other for directional control and trim, and (3) together for flight braking. (See figure 1-16.)

1-120. **RUDDER CONTROL SYSTEM.**

1-121. The rudders are each actuated by two hydraulic cylinders, inboard and outboard, which obtain operating pressure from the inboard and outboard power surface control hydraulic systems, respectively, on each side of the airplane. Hydraulic pressure to the actuating cylinders is regulated by servo-valves that are operated through cable systems by the independent rudder pedals. Resistance to rudder pedal movement, or "feel," is provided by springs attached to the pedal mechanisms. There are no emergency controls for rudder operation. A combination manual and automatic rudder trim system is provided which operates the rudders for directional stability and trim.

1-122. **RUDDER PEDALS.** Conventional rudder pedals, pivoting from the top, are installed at each pilot's station for operation of the rudders. The left and right pedals are not interconnected. Movement of one rudder pedal opens the corresponding rudder so that its surfaces deflect above and below the trim flap surfaces, creating drag on that side of the airplane. Simultaneous movement of both rudder pedals opens both rudders for flight braking. An adjustment knob on each pedal mounting base provides for adjustment of the pedals to meet the requirements of different pilots.

1-123. **RUDDER TRIM CONTROL SYSTEM.**

1-124. Electric motor-driven mechanisms, capable of opening either rudder up to 26°, are installed adjacent to each trim flap and are controlled by operation of the yaw stabilizer system and a control knob on the pilot's pedestal.

1-125. **YAW STABILIZER SYSTEM.** This system consists of a directional rate-gyro and electrical circuits to the motor-driven rudder operating mechanisms. When the airplane yaws in one direction, the rate-gyro transmits electrical signals to the servo mechanism at the opposite rudder, causing that rudder to open the necessary amount to correct the yaw condition. The yaw stabilizer system electrical circuits are energized at all times that the battery switch, on the engineer's switch panel,

is on, and are protected by a circuit breaker (15, figure 1-20) on the pilot's pedestal. Because manual rudder trim control and auto-pilot rudder trim control are obtained through the yaw stabilizer electrical circuits, the yaw stabilizer circuit breaker must be closed in order to obtain rudder motion by any of the three trimming methods.

1-126. **RUDDER TRIM CONTROL KNOB.** A manually-operated rudder trim control knob (36, figure 1-20) is provided on the pilot's pedestal. This knob is used to manually set rudder trim in addition to that provided by the automatic yaw stabilizer; the knob is also used, in place of the auto-pilot rudder trim control, for setting rudder trim when the auto-pilot is operating. The control knob has a center position for "0" trim (rudders closed); rotation of the knob to the right or the left of this position causes the corresponding rudder to be opened a proportionate amount.

1-127. **TRIM FLAPS.**

1-128. The trim flaps can be operated up or down together and/or in opposite directions to provide pitch or roll trim or a combination of both. (See figure 1-16.) The rudders, which are hinged to and form the trailing edges of the trim flaps, move with the trim flaps for "elevator" and "aileron" trim control. Controls and position indicators for the trim flaps are provided on both pilots' pedestals.

1-129. **TRIM FLAP CONTROL SYSTEM.**

1-130. Each trim flap is actuated by two hydraulic cylinders, inboard and outboard, which normally obtain operating pressure from the inboard and outboard power surface control hydraulic systems, respectively, on each side of the airplane. Hydraulic pressure to the actuating cylinders is regulated by servo-valves that are operated through cable systems by the trim control wheels in the cockpit. In the event of failure in the power surface control hydraulic systems, one actuating cylinder of each trim flap can be supplied with hydraulic pressure by the corresponding emergency elevon and trim flap hydraulic systems, allowing partial operation of the trim flaps.

1-131. **TRIM FLAP CONTROL WHEELS AND INDICATORS.** Two trim flap control wheels (28, figure 1-20, and 7, figure 1-24) are mounted on the left side of each pilot's pedestal. The right-hand wheel in each pedestal controls movement of the right-hand trim flap and the left-hand wheel controls movement of the left-hand trim flap. Simultaneous movement of both control wheels operates both trim flaps together, either up or down, for pitch or "elevator" trim. Moving the control wheels in opposite directions moves one trim flap up and the other down for roll or "aileron" trim. Combined movements of the control wheels can be made to obtain combinations of roll and pitch trim. Trim-flap "aileron" trim and "elevator" trim indicators (16 and 17, figure 1-20; 3 and 11, figure 1-24) are located on each pilot's pedestal. The markings on these indicators do not indicate degrees of trim; they indicate the relative amounts of trim being used. A trim flap circuit breaker (5, figure 1-20), on the pilot's pedestal, protects the trim indicators electrical circuit.

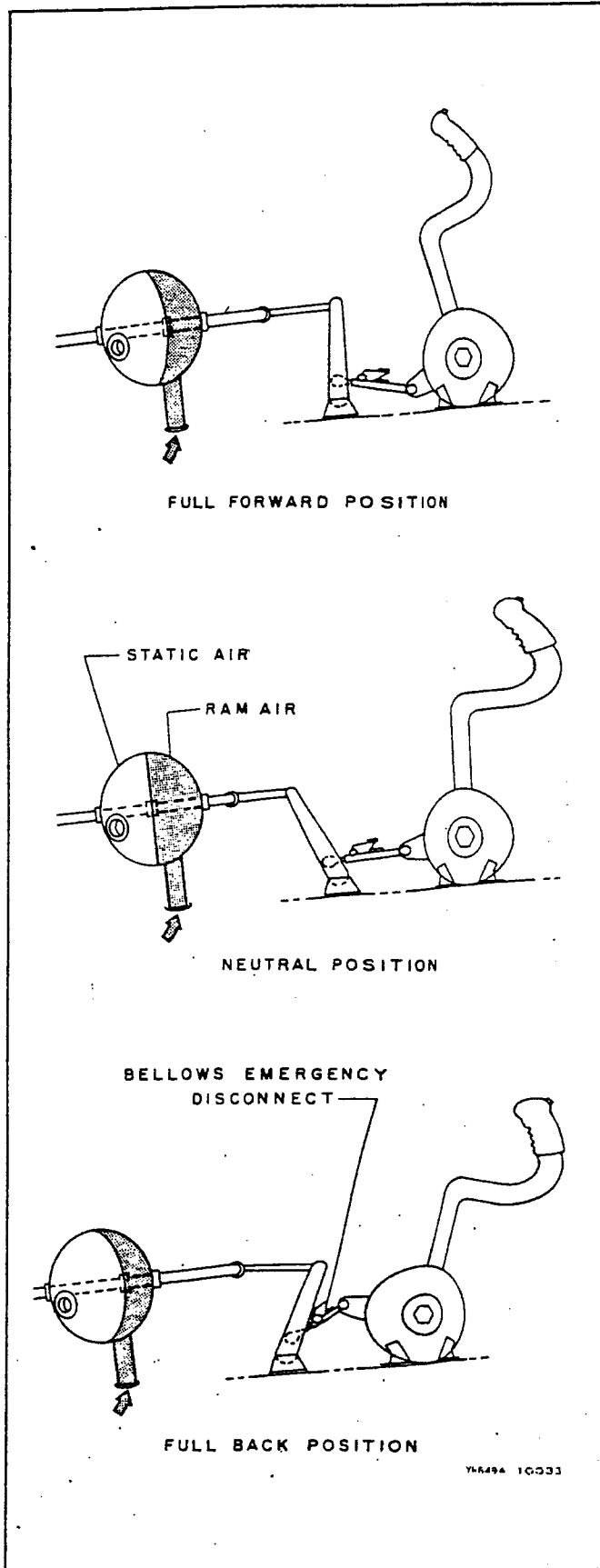

Figure 1-15. Elevon Force Bellows Action

tudes of surface movement, by operation of the emergency elevon and trim flap system. This system is controlled by the emergency elevon control buttons (18, figure 1-19; 7, figure 1-23) on the control stick grips. Operation of the button switches supplies dc power from the airplane's battery to the motor-driven emergency hydraulic pumps and opens solenoid valves which permit emergency hydraulic pressure to be delivered to the outboard actuating cylinders of the elevons and the trim flaps. An emergency elevon circuit breaker (2, figure 1-20) on the pilot's pedestal, protects the emergency elevon and trim flap system electrical circuit.

1-134. LANDING FLAPS.

1-135. Conventional landing flaps are incorporated in the trailing edge of the wing between the inboard vertical stabilizers and the crew nacelle.

1-136. LANDING FLAP CONTROL SYSTEM.

1-137. The landing flaps are operated by an electric motor-driven gear box assembly through a series of torque-tubes and universal joints. Two ac motors drive the gear box assembly. In the event that one motor fails, the flaps may be operated by the other motor. The two motors have integral brake assemblies which hold the flaps in the position selected. The motors operate the flaps through a differential gearing, and both motors must be operating, or the brake on one engaged, in order to move the flaps. Normal control switches on the pilots' pedestals and individual motor switches and a reset lever on the power unit control the operation of the flap motors.

1-138. LANDING FLAP NORMAL CONTROL SWITCHES AND POSITION INDICATORS.

1-139. The landing flap control switches (18, figure 1-20; 8, figure 1-24) are located on the pilots' pedestals. The switches have "UP," "OFF" and "DOWN" positions. Flap movement may be stopped at any position by returning a switch to the "OFF" position. Landing flap position indicators (19, figure 1-20; 10, figure 1-24) are located on the pedestals next to each control switch. Landing flap control and position indicator circuit breakers (44 and 43, figure 1-20), protecting the circuits for landing flap control and position indicators, are located on the pilot's pedestal.

1-140. LANDING FLAP EMERGENCY CONTROLS.

1-141. Landing flap emergency controls are installed on the flap power unit, located on the aft face of the bulkhead between the crew nacelle center and aft sections.

1-142. LANDING FLAP EMERGENCY MOTOR SELECTOR SWITCHES. The landing flap emergency motor selector switches (1, figure 1-17), located on the face of the flap power unit, control the individual flap drive motors. If the flaps fail to operate due to a motor failure, placing one of the normal flap control switches in the desired position and then alternately turning off and on the individual motor switches will identify which motor is inoperative. The

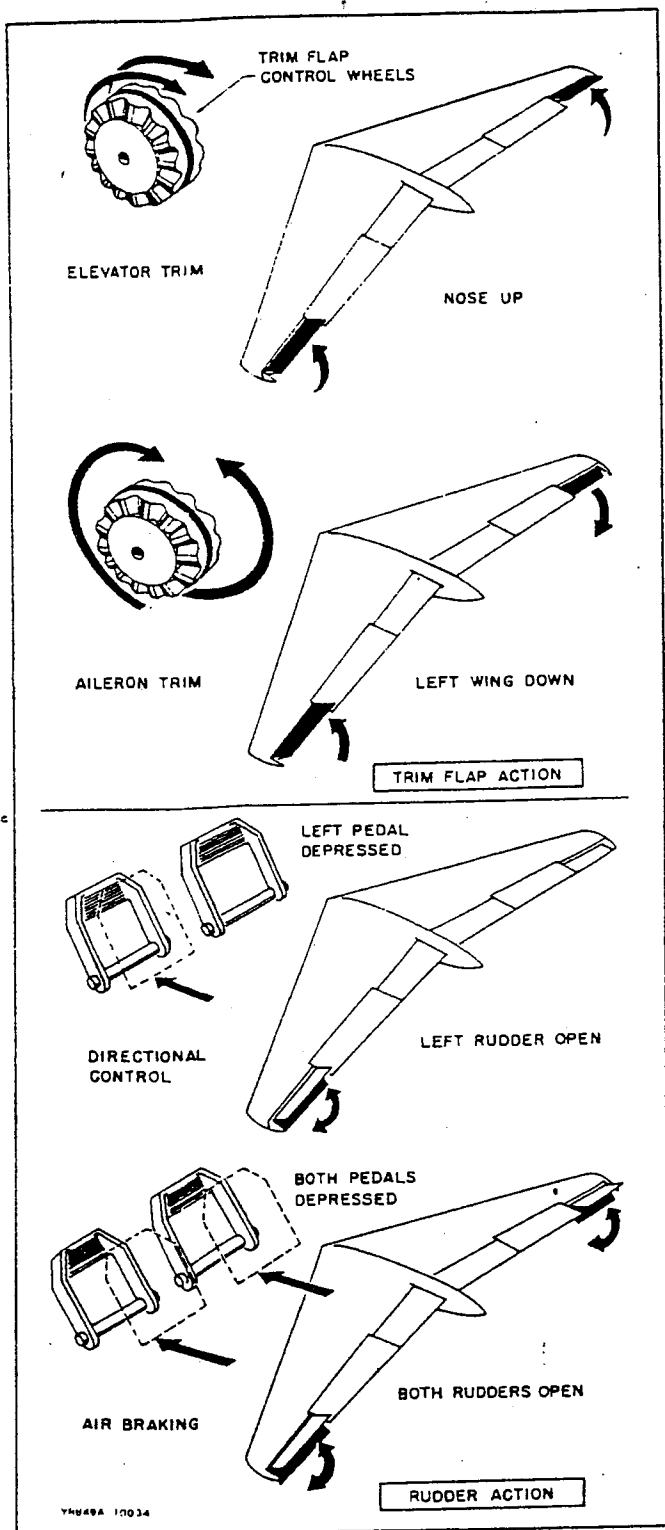
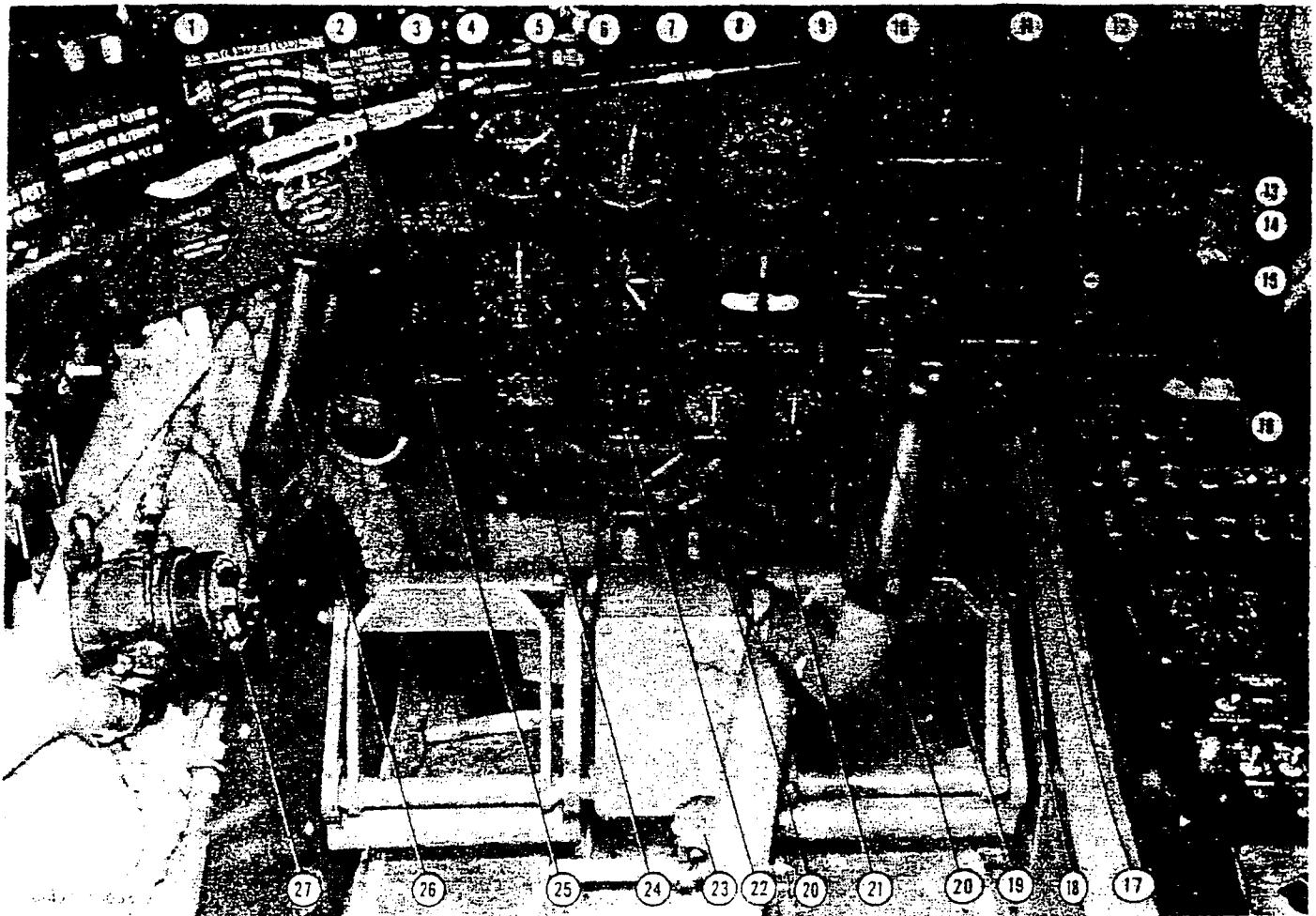

Figure 1-16. Trim Flap and Rudder Action

1-132. EMERGENCY ELEVON AND TRIM FLAP CONTROL SWITCHES.

1-133. In the event of failure in the power surface control hydraulic systems, emergency operation of the elevons and the trim flaps may be obtained, at reduced speeds and magni-





- |  |   |
|--|---|
| 1. OXYGEN GAGE PANEL                       | 14. CAMERA INTERVALOMETER WARNING LIGHT       |
| 2. ENGINE FIRE INDICATOR LIGHT             | 15. PHOTO OPERATIONS INDICATOR LIGHT          |
| 3. YAW INDICATOR                           | 16. PILOT'S PEDESTAL                          |
| 4. ACCELEROMETER                           | 17. STATIC PRESSURE SELECTOR VALVE            |
| 5. ALTIMETER                               | 18. EMERGENCY ELEVON CONTROL BUTTON           |
| 6. AIRSPEED INDICATOR                      | 19. AUTO-PILOT RELEASE BUTTON                 |
| 7. TURN AND BANK INDICATOR                 | 20. WING SLOT OPEN INDICATOR LIGHTS           |
| 8. DIRECTIONAL GYRO INDICATOR              | 21. TACHOMETERS                               |
| 9. RATE OF CLIMB INDICATOR                 | 22. FREE AIR TEMPERATURE INDICATOR            |
| 10. GYRO HORIZON INDICATOR                 | 23. RUDDER PEDAL ADJUSTMENT KNOB              |
| 11. SLAVED GYRO MAGNETIC COMPASS           | 24. STEER METER                               |
| 12. LANDING GEAR POSITION INDICATOR LIGHTS | 25. ENGINE OVERHEAT WARNING LIGHT             |
| 13. STANDBY MAGNETIC COMPASS               | 26. NOSE WHEEL STEERING AND HAND BRAKE HANDLE |
|  | 27. OXYGEN REGULATOR                          |

Figure 1-19. Pilot's Station - Forward

Section I  
Paragraphs 1-148 to 1-152

wing slot open indicator lights (20, figure 1-19; 11, figure 1-23) are installed on each pilot's instrument panel.

1-149. STALL WARNING SYSTEM.

1-150. A stall warning horn and red indicator light are installed just forward of the pilot's throttle levers. The warning horn and light are operated by air pressure-actuated switches in the wing skin; the horn blows and the light illuminates when the airplane's airspeed is approximately 13 knots above the airspeed at which the airplane will stall. Operation of the horn and light may be tested by means of a stall warning test switch (35, figure 1-20) on the pilot's pedestal. The stall warning system electrical circuit is controlled by a circuit breaker (4, figure 1-20) on the pilot's

pedestal.

1-151. AUTOMATIC PILOT.

1-152. The Type E-7 automatic pilot installed in the airplane is a standard type except for one added element, a sideslip sensing vane. This vane senses a sideslip condition of airplane trim and imparts a correcting signal to the auto-pilot, which then actuates the proper control surface to remove the sideslip. An auto-pilot control panel is installed just aft of the pilot's pedestal. A remote turn control knob is located at the radar-navigator's station. Auto-pilot release switches are provided in the control stick grips. The auto-pilot electrical circuit is protected and controlled by a circuit breaker switch (8, figure 1-20) on the pilot's pedestal.

- |   |  |
|---|--|
| 1. Bank and Turn Indicator Circuit Breaker                    | 24. Pilot's Red Lights Rheostat                            |
| 2. Emergency Elevon Circuit Breaker                           | 25. Landing Gear Handle                                    |
| 3. Wing Slots Circuit Breaker                                 | 26. Landing Gear Warning Silencer Switch                   |
| 4. Stall Warning Circuit Breaker                              | 27. Auto-Pilot Control Panel                               |
| 5. Trim Flaps Indicators Circuit Breaker                      | 28. Trim Flap Control Wheels                               |
| 6. Air Temperature Indicator Circuit Breaker Switch           | 29. Landing Gear Handle Emergency Release Knob             |
| 7. Photo-Navigator's Windshield Wiper Circuit Breaker Switch  | 30. Command Radio Controls                                 |
| 8. Auto-Pilot Circuit Breaker Switch                          | 31. Liaison Radio Controls                                 |
| 9. Pilot's Windshield De-Icing and De-Fogging Circuit Breaker | 32. Navigation Lights Switches                             |
| 10. Pilot's Windshield De-Fogging Switch                      | 33. Fuselage Position Lights Switch and Key                |
| 11. Pilot's Windshield De-Icing Switch                        | 34. Wing Slot Switch                                       |
| 12. Magnetic Compass Light Circuit Breaker Switch             | 35. Stall Warning Test Switch                              |
| 13. Pilot's Instrument Lights Circuit Breaker Switch          | 36. Rudder Trim Control Knob                               |
| 14. Pilot's Pedestal Lights Circuit Breaker                   | 37. Cockpit Lights Circuit Breaker                         |
| 15. Yaw Stabilizer Circuit Breaker                            | 38. Landing Gear Position Indicator Lights Circuit Breaker |
| 16. Trim Flaps Aileron Trim Indicator                         | 39. Landing Lights Circuit Breaker                         |
| 17. Trim Flaps Elevator Trim Indicator                        | 40. Formation Lights Circuit Breaker                       |
| 18. Landing Flap Switch                                       | 41. Flashing Navigation Lights Circuit Breaker             |
| 19. Landing Flap Position Indicator                           | 42. Fuselage Position Lights Circuit Breaker               |
| 20. Landing Lights Switch                                     | 43. Landing Flap Position Indicator Circuit Breaker        |
| 21. Formation Lights Switch                                   | 44. Landing Flap Control Circuit Breaker                   |
| 22. Standby Compass Light Rheostat                            | 45. Nose Steering and Brakes Circuit Breaker               |
| 23. Pilot's Ultraviolet Lights Rheostat                       | 46. Landing Gear Control Circuit Breaker                   |

Figure 1-20 (Sheet 1 of 2 sheets). Pilot's Pedestal

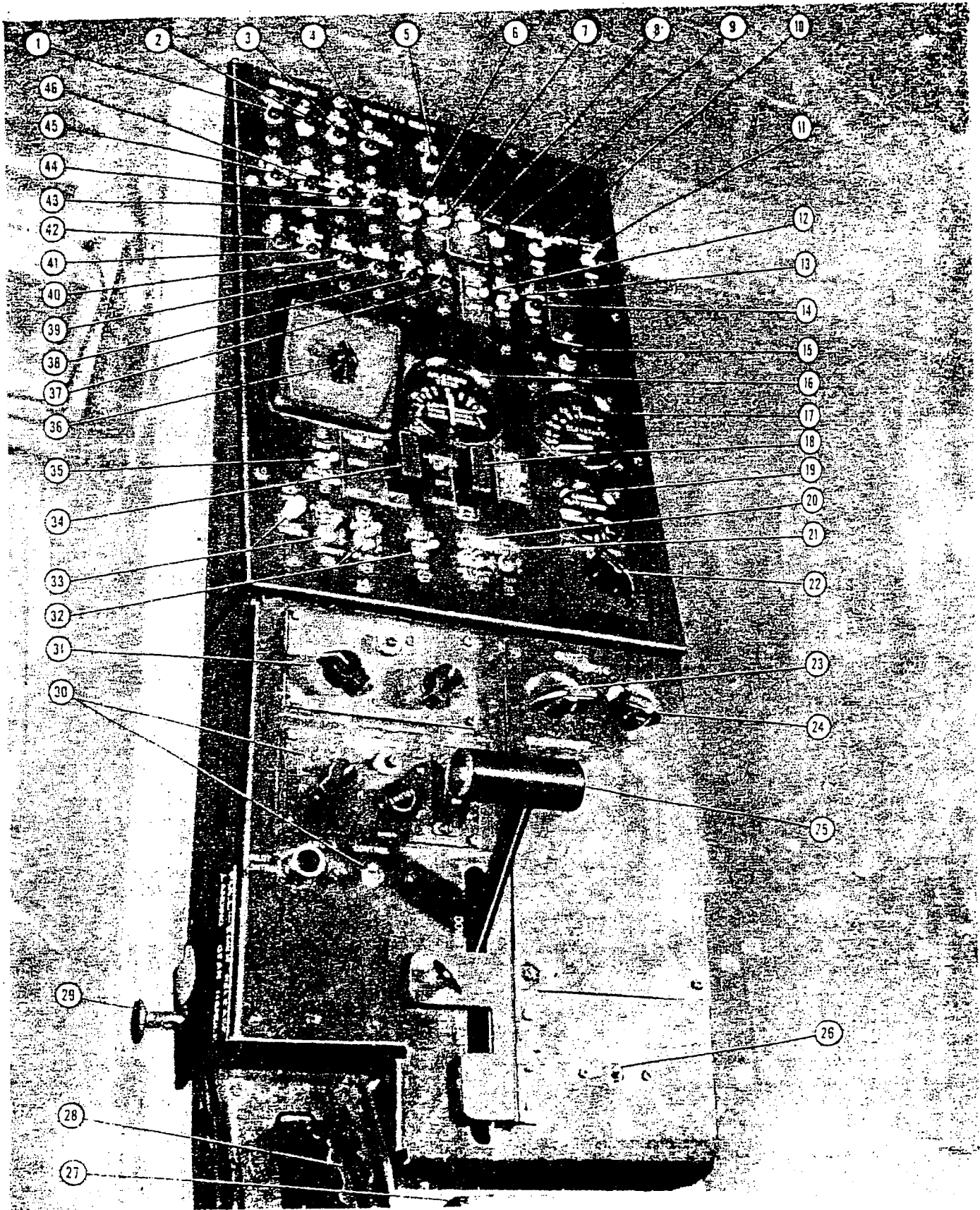
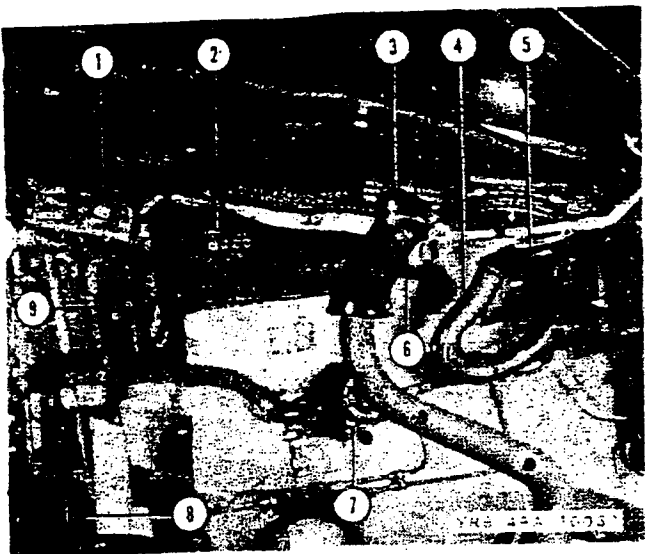

Figure 1-20 (Sheet 2 of 2 sheets). Pilot's Pedestal



1. ENCLOSURE ESCAPE PANEL RELEASE HANDLE
2. INTERPHONE PANEL
3. CONTROL STICK
4. NOSE WHEEL STEERING AND HAND BRAKE HANDLE
5. OXYGEN GAGE PANEL
6. MICROPHONE SWITCH
7. OXYGEN REGULATOR
8. HEATED CLOTHING CONTROL BOX
9. BOMB SALVO SWITCH

Figure 1-21. Pilot's Station - Left Side

1-153. AUTO-PILOT CONTROLS.

1-154. AUTO-PILOT MASTER SWITCH. When the auto-pilot master switch (2, figure 1-18) on the auto-pilot control panel is placed in the "ON" position, it closes the auto-pilot electrical circuits and places the system in operation. However, the system is not engaged with the airplane's control systems until the engage button switch is pressed.

1-155. AUTO-PILOT ENGAGE BUTTON SWITCH. The engage button switch (6, figure 1-18) on the auto-pilot control panel is operated to engage the entire auto-pilot system simultaneously.

1-156. AUTO-PILOT YAW CONTROL SWITCH. The auto-pilot yaw control switch (3, figure 1-18) can be operated to turn on and off the sideslip sensing element of the auto-pilot. For all normal operation of the auto-pilot, this switch should be left in the "ON" position so that the sideslip sensing circuit will be energized.

1-157. AUTO-PILOT TRIM CONTROL KNOBS. Three auto-pilot trim control knobs (4, 5, and 7,

figure 1-18) are provided on the auto-pilot control panel for setting rudder, "aileron," and "elevator" trim. In this airplane, rudder trim settings are made, when necessary, by means of the rudder trim control knob (36, figure 1-20) on the pilot's pedestal, whether the airplane is under manual or auto-pilot control. The automatic yaw stabilizer system, which operates at all times, normally makes any rudder trim corrections that may be necessary. The auto-pilot rudder trim control knob (5, figure 1-18) on the auto-pilot control panel should not be used. A push-to-release button is mounted in the center of each auto-pilot trim control knob. Pressure on a button disengages that particular channel of the auto-pilot system. The channel may be re-engaged by momentarily depressing the engage button. In addition to its use for setting "elevator" trim into the auto-pilot, the auto-pilot "elevator" trim knob (4, figure 1-18) is used for dive and climb control, within the limits of the auto-pilot, in the same manner as the auto-pilot turn control knob (8, figure 1-18) is used for directional control.

1-158. AUTO-PILOT TURN CONTROL KNOB. By operation of the auto-pilot turn control knob (8, figure 1-18), the pilot can introduce signals into the auto-pilot system which will maneuver the airplane in a properly banked turn while flying under auto-pilot control.

1-159. AUTO-PILOT TURN CONTROL TRANSFER KNOB. The auto-pilot turn control transfer knob (1, figure 1-18) is operated to transfer auto-pilot turn control to the remote turn control knob at the radar-navigator's station. The knob operates a double-pole switch and fader-type potentiometer. As the knob is turned from the "PILOT" position to the "REMOTE" position, control is gradually transferred to the remote station. The gradual transfer feature is designed to prevent violent action of the auto-pilot to establish new trim settings if the remote turn control knob is not centered.

1-160. AUTO-PILOT REMOTE TURN CONTROL KNOB. The auto-pilot remote turn control knob (21, figure 4-7) is mounted to the left of the ballistics computer panel at the radar-navigator's station. When the pilot's turn control transfer knob is in the "REMOTE" position, the navigator has complete directional control of the airplane through the auto-pilot system. Properly banked turns may be made by operation of the knob, and the amount of turn is proportional to the movement of the turn control knob.

1-161. AUTO-PILOT RELEASE SWITCHES. An auto-pilot release switch (19, figure 1-19; 6, figure 1-23) is provided in the top of the grip of each control stick. Either pilot may release the auto-pilot by momentarily pressing the release switch on his control stick. The auto-pilot is re-engaged in the normal manner by pressing the engage switch on the auto-pilot control panel.

1-162. LANDING GEAR.

1-163. GENERAL.

1-164. The landing gear and the landing gear



fairing doors are actuated by ac electric motors. The doors close and lock when the gear is retracted, and, with the exception of the strut doors, they close, but do not lock, after the gear is extended. The gear is locked in up or down position by electrically-actuated uplocks and downlocks. The gear actuators, uplocks and downlocks, door actuators and door locks operate in automatic sequence, for normal extension and retraction, in response to movement of the landing gear control handles on the pilots' pedestals. An emergency release system is provided for releasing the gear and doors from the uplocks for emergency extension. Air-oil bungees, attached to the gear units and to the nose gear doors, assure engagement of the gear in the downlocks in either normal or emergency extension. A positive control handle locking arrangement prevents inadvertent retraction of the gear when the airplane is on the ground.

1-165. LANDING GEAR NORMAL OPERATION.

1-166. After take-off, when the weight of the airplane is off the gear, the push-button switch in the end of one of the landing gear control handles is pressed to energize the solenoid which releases the handle lock, and the handle is moved to the "UP" position. This movement closes switches which start the door actuating motors, opening the doors. When the doors are open, the downlocks are released and the gear actuating motors are automatically started. Retraction of the gear into the uplocks and subsequent closing and locking of the fairing doors are automatically accomplished by the chain-sequence operation of limit switches and sequence switches. For normal extension of the gear, one of the landing gear control handles is moved to the "DOWN" position. Movement of the handle to that position unlocks the door locks by means of cable

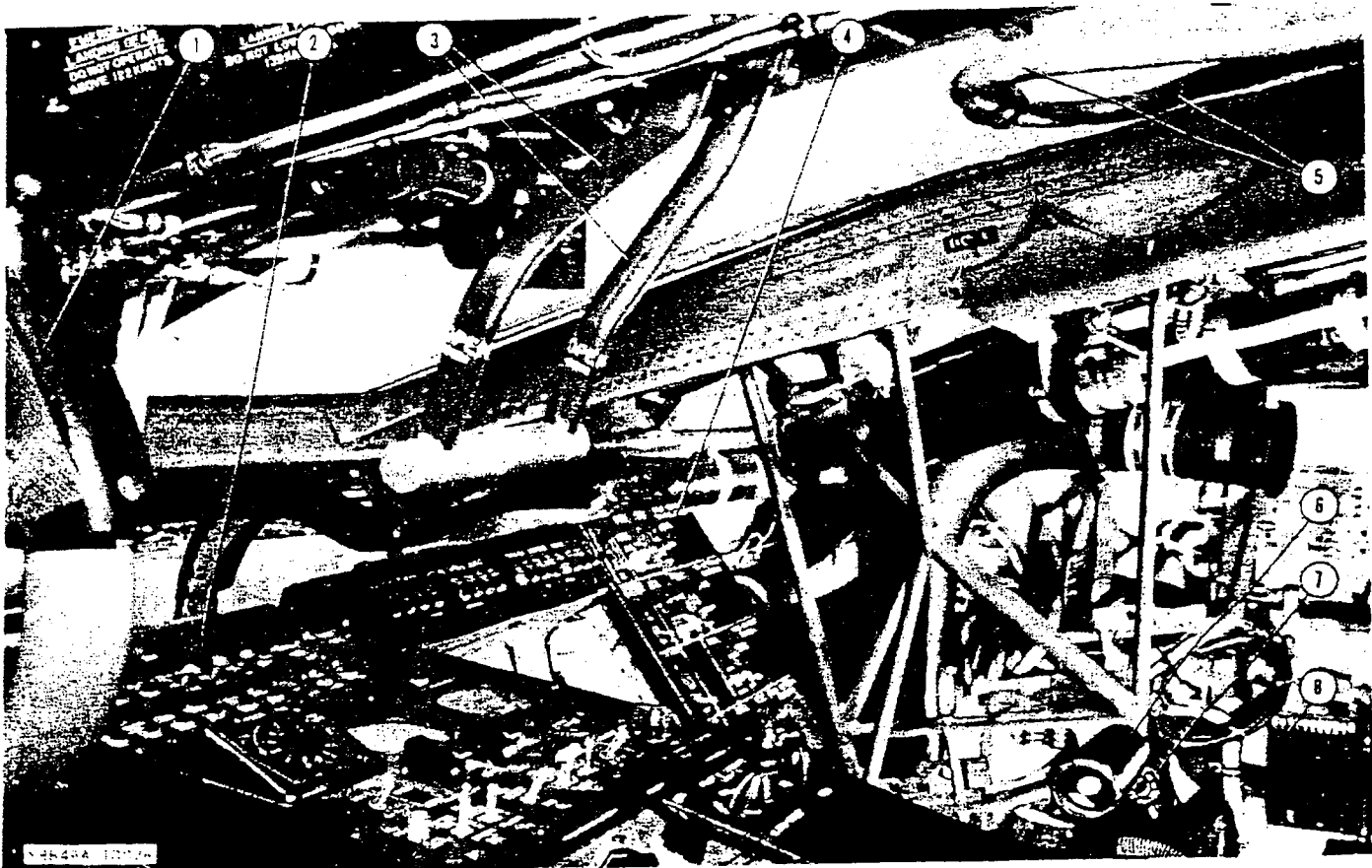

- |                                    |  |
|------------------------------------|--|
| 1. CONTROL STICK                   | 5. EMERGENCY AIR BRAKE LEVERS                    |
| 2. PILOT'S PEDESTAL                | 6. PILOT'S LANDING GEAR CONTROL HANDLE           |
| 3. PILOT'S THROTTLE LEVERS         | 7. PHOTO-NAVIGATOR'S OXYGEN REGULATOR            |
| 4. PHOTO-NAVIGATOR'S CONTROL PANEL | 8. PHOTO-NAVIGATOR'S HEATED CLOTHING CONTROL BOX |

Figure 1-22. Pilot's Station - Right Side

systems. When the door locks are fully open, they contact switches which start the door actuating motors, opening the doors. Subsequent extension of the gear and closing of the doors is accomplished by operation of limit switches and sequence switches. The downlocks are automatically actuated to the locked position by entry of lugs attached to the landing gear struts.

1-167. LANDING GEAR CONTROLS AND INDICATORS.

1-168. LANDING GEAR CONTROL HANDLES. The landing gear control handles (25, figure 1-20; 9, figure 1-24), located on the pilots' pedestals, have two positions, "UP" and "DOWN." When a handle is in the "DOWN" position, a solenoid-operated plunger locks the handle in that position. When the weight of the airplane is not on the gear, the handle lock may be released by pressing in on the push-button switch in the end of the handle. When the weight of

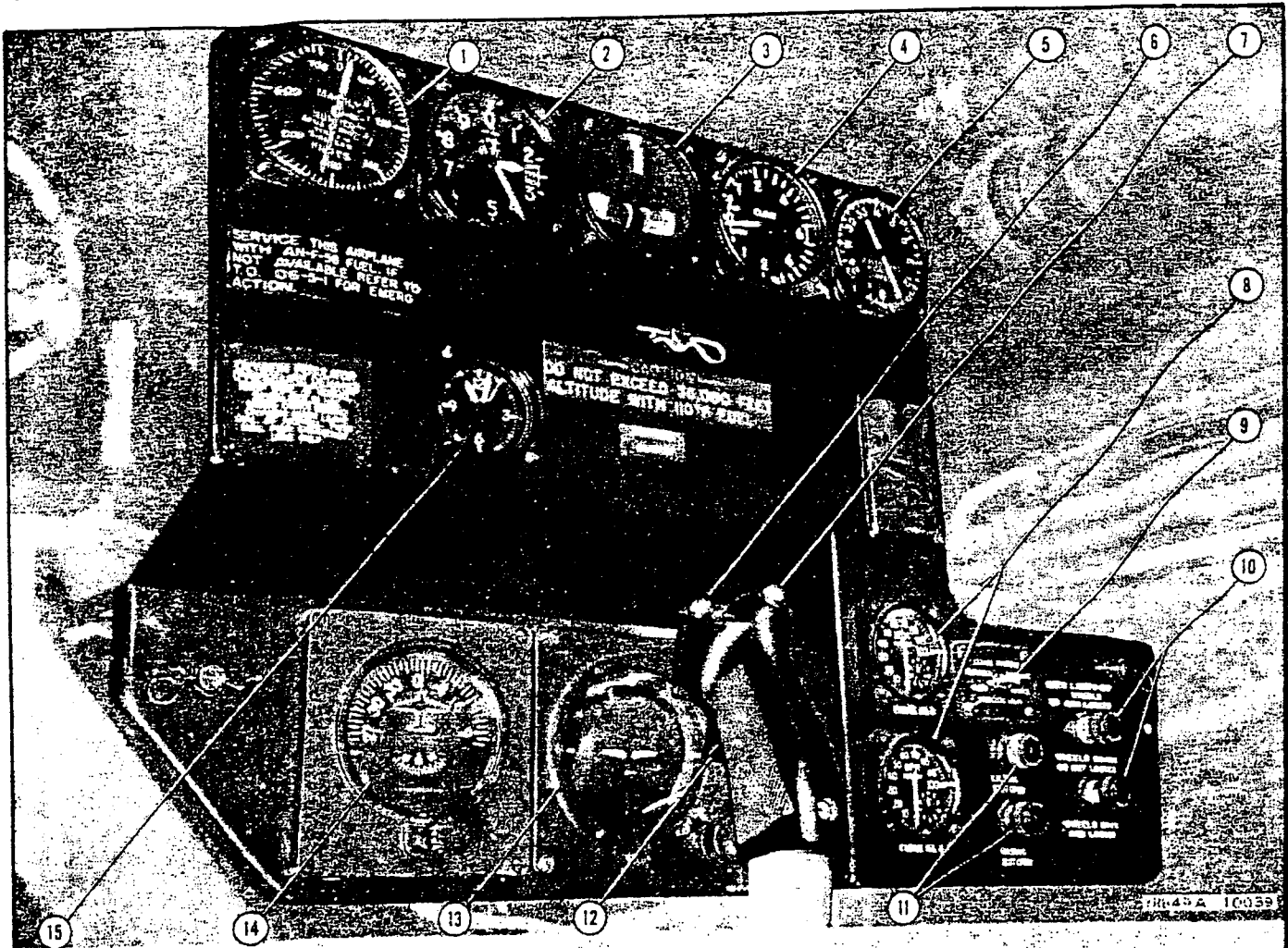

- |                                    |  |
|------------------------------------|--|
| 1. AIRSPEED INDICATOR              | 8. TACHOMETERS                             |
| 2. ALTIMETER                       | 9. STATIC PRESSURE SELECTOR VALVE          |
| 3. TURN AND BANK INDICATOR         | 10. LANDING GEAR POSITION INDICATOR LIGHTS |
| 4. RATE OF CLIMB INDICATOR         | 11. WING SLOT OPEN INDICATOR LIGHTS        |
| 5. SLAVED GYRO MAGNETIC COMPASS    | 12. MICROPHONE SWITCH                      |
| 6. AUTO-PILOT RELEASE BUTTON       | 13. GYRO HORIZON INDICATOR                 |
| 7. EMERGENCY ELEVON CONTROL BUTTON | 14. DIRECTIONAL GYRO INDICATOR             |
|                                    | 15. CLOCK                                  |

Figure 1-23. Copilot's Instrument Panel

landing gear circuit is located on the pilot's pedestal.

1-169. LANDING GEAR HANDLE EMERGENCY RELEASE KNOB. The landing gear handle emergency release knob (29, figure 1-20), on the left side of the pilot's pedestal, can be operated to manually release the handle lock for normal gear retraction in flight, in the event of malfunction of the handle lock circuit.

1-170. LANDING GEAR EMERGENCY RELEASE. A landing gear emergency release handle (figure 1-27) for emergency release of the landing gear is located on the side of the oxygen tank well in the center crew nacelle section. This handle operates a cable system which unlocks the fairing doors, releases the gear uplocks and disengages the clutches of the landing gear actuator motors, allowing the gear units to fall of their own weight to a point where the air-oil bungees will force them into the downlocks. The handle is operated in the same manner as a socket wrench ratchet handle. A small ratchet selector lever on the handle regulates the direction of the ratchet action. The release handle normally hangs downward with the ratchet selector lever in the "LOCK GEAR" position. Keeping the ratchet selector lever in the "LOCK GEAR" position prevents accidental operation of the emergency release. When the

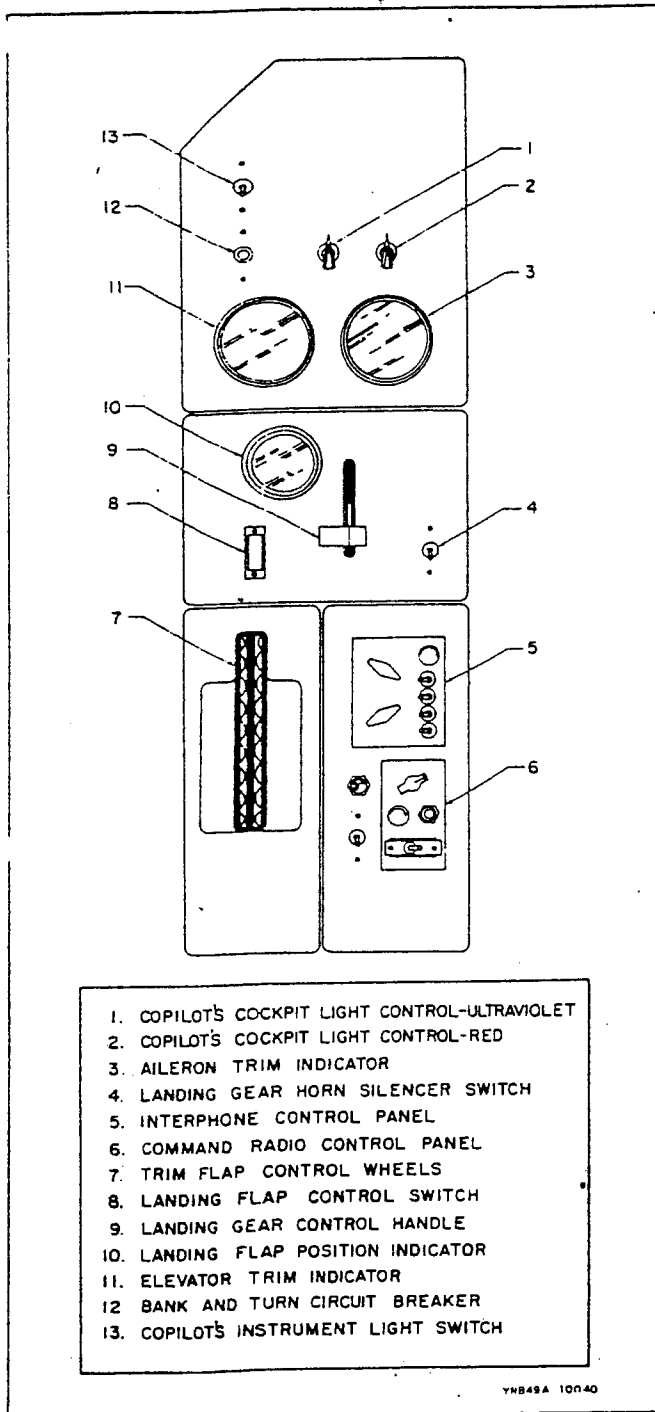

Figure 1-24. Copilot's Pedestal

the airplane is on the gear, a gear-operated switch opens the solenoid circuit, making it impossible to release the handle lock and move the handle without manually releasing the solenoid by pulling the landing gear handle emergency release knob on the left side of the pilot's pedestal. To do this requires the use of both hands, which reduces the chance of inadvertent retraction of the gear while the airplane is on the ground. A landing gear control circuit breaker (46, figure 1-20) for the

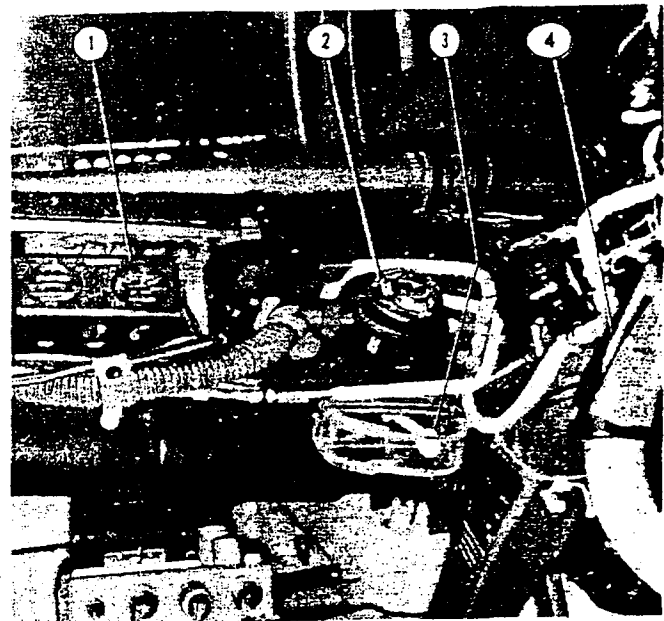

Figure 1-25. Copilot's Station - Left Side

ratchet selector lever is in the "UNLOCK GEAR" position, the handle is set to release the gear and raising it up and down in five 90° movements fully releases the gear uplocks and door locks. A pointer, located on the panel above the emergency release handle and operated by the handle, indicates "GEAR LOCKED" and "GEAR UNLOCKED" conditions. Once this system has been used, the normal control handles should be left in the "DOWN" position. When the system is operated, it destroys the normal operational sequence timing and the landing gear system must be reset by the ground crew to restore it to normal operating condition.

1-171. LANDING GEAR POSITION INDICATOR LIGHTS. Two landing gear position indicator lights (12, figure 1-19; 10, figure 1-23), one red and the other green, are located on each pilot's instrument panel. The red light is on when the gear is in motion or is down but not locked. The green light is on when the gear units are all locked in down position. When the gear is up and locked, both lights are out.

1-172. LANDING GEAR WARNING HORN. A landing gear warning horn sounds to indicate that the landing gear is not down and locked under the following three combined conditions: when the airplane is flying below 10,000 feet altitude, the airplane's speed is below 139 knots, and the throttles are not fully advanced. Opening

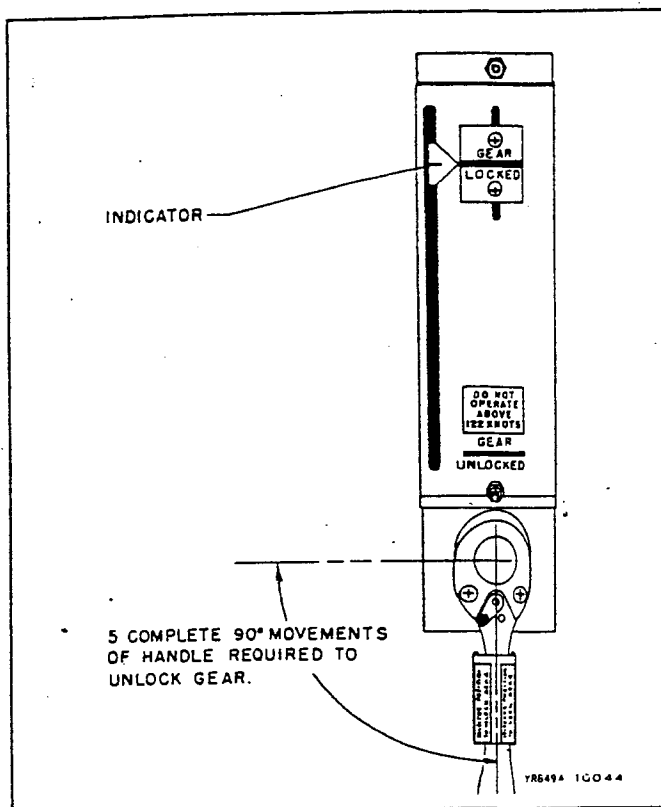

Figure 1-27. Landing Gear Emergency Release (On Side of Oxygen Tank Well)

the throttles, increasing the airspeed, or ascending above 10,000 feet will stop the horn blowing. A landing gear warning silencer switch (26, figure 1-20; 4, figure 1-24) is provided on each pilot's pedestal for turning off the warning horn.

1-173. LANDING GEAR BUNGEEES.

1-174. Each main gear unit is equipped with two bungees, the nose gear with one, and the forward and aft nose gear doors with one each. As the gear units extend, approaching the downlocks, air-oil pressure forces the bungee cylinders against the gear units, pushing them into the downlocks. The systems should not have to be recharged, since retraction of the gear compresses the bungee cylinders and automatically restores the pressure in the bungee systems. However, each bungee pressure gage should be checked before flight.

1-175. STEERING SYSTEM.

1-176. GENERAL.

1-177. The nose-wheel is equipped with a "steer-damp" unit which permits automatic swiveling or controlled steering of the wheel through an arc of 98°. For uncontrolled swivel action the unit functions as a hydraulic damper. For steering, hydraulic pressure from the brakes and steering hydraulic system is admitted to the unit. The steering unit can be operated only when the nose gear strut is compressed by the weight of the airplane.

1-178. STEERING HANDLE.

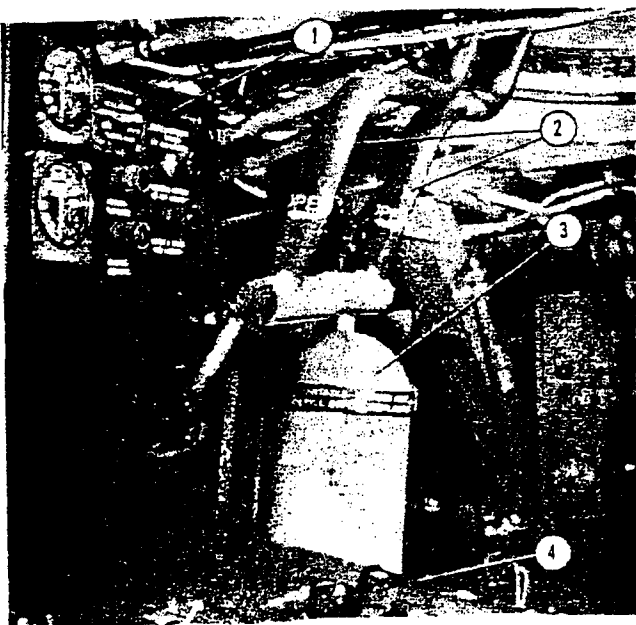

1. INSTRUMENT PANEL
2. COPILOT'S THROTTLE LEVERS
3. PORTABLE OXYGEN BOTTLE
4. COPILOT'S PEDESTAL

YR649A 10042

Figure 1-26. Copilot's Station - Right Side

179. The nose wheel steering and hand brake handle (26, figure 1-19) is located to the left of the pilot's instrument panel. When the handle is grasped and the trigger-switch pressed, hydraulic pressure is supplied to the steering unit and rotating the handle to the left or right turns the nose wheel a proportional amount in the same direction. The handle is also used for operation and setting of the main gear brakes.

1-180. BRAKE SYSTEMS.

1-181. GENERAL.

1-182. Each main gear wheel is equipped with a spot-type hydraulic brake supplied with hydraulic pressure by the brakes and steering hydraulic system. The motor-driven pump of the brakes and steering hydraulic system is actuated by switches on the landing gear and the nose gear doors; therefore, the brakes can be operated only when the landing gear is down and locked, with the forward main gear doors closed. An emergency air brake system is also provided. The air brake system uses a working air pressure of 1500 psi supplied by an air storage bottle located in the nose wheel well. The air bottle contains sufficient air pressure for three complete actuations of the brakes.

1-183. BRAKE CONTROLS.

1-184. BRAKE PEDALS. The toe portion of each rudder pedal pivots at the heel for foot operation of the hydraulic brakes.

1-185. HAND BRAKE HANDLE. The hydraulic brakes can be actuated by pulling the nose wheel steering and hand brake handle (26, figure 1-19) straight back without depressing the trigger switch in the handle. Uniform application of the brakes on both main gear, for braking the airplane while taxiing straight ahead or landing, may be obtained in this manner. The brakes are set for parking by pulling the handle full back. A friction mechanism holds the handle in the rear position until the trigger is depressed and the handle moved forward.

1-186. EMERGENCY AIR BRAKE CONTROL LEVERS. Two emergency air brake control levers (5, figure 1-22) are located overhead to the right of the pilot. Metered air pressure may be applied to the brakes of either or both main landing gear by pulling down on the levers. When the handles are released, they automatically return to the up position, cutting off the emergency air supply and releasing the brakes. The levers should be operated cautiously and not abruptly.

1-187. INSTRUMENTS.

1-188. GENERAL.

1-189. All gyro instruments are electrically driven. The fuel level indicators are self-operated. Fuel and oil pressure instruments are actuated by autosyn-type fluid pressure transmitters.

1-190. STATIC PRESSURE SELECTOR VALVES.

1-191. Static pressure selector valves (1, figure 1-5; 17, figure 1-19; 9, figure 1-23;

9, figure 4-5) are provided on the pilots' instrument panels, above the engineer's engine instrument panel and on the radar-navigator's switch panel. The selector valves are normally wired in the "AIRSPEED TUBE" position, and the instruments which operate on atmospheric static pressure receive static air from the pitot tubes. In the event of failure of the pitot tube static air pressure, the selector valves can be turned to the "ALTERNATE SOURCE" positions to supply the same instruments with static air from within the wing.

1-192. AIR TEMPERATURE GAGES.

1-193. Free air temperature gages (9, figure 1-5; 22, figure 1-19; 13, figure 4-7) are installed on the pilot's, radar-navigator's and engineer's instrument panels. A cabin air temperature gage (7, figure 1-5) is installed on the engineer's instrument panel. The air temperature gages are actuated by electrical resistance-type bulbs, operated on 28-volt dc. The temperature gage electrical circuits are energized by the operation of free air temperature circuit breaker switches (3, figure 1-4; 6, figure 1-20; 6, figure 4-5), one of which is located at each station.

1-194. STANDBY COMPASS.

1-195. A standby magnetic compass (13, figure 1-19) is installed on the pilot's instrument panel.

1-196. CABIN AIR PRESSURE INSTRUMENTS.

1-197. A cabin rate-of-climb indicator (5, figure 1-5) and a cabin altimeter (4, figure 1-5) are installed on the engineer's instrument panel.

1-198. YAW INDICATOR.

1-199. A yaw indicator (3, figure 1-19) on the pilot's instrument panel, indicates the degree of yaw of the airplane during autopilot operation only.

1-200. EMERGENCY EQUIPMENT.

1-201. ENGINE OVERHEAT WARNING SYSTEM.

1-202. Overheat detector units, installed in the aft sections of the engine compartments and the engine pods, are connected to warning lights in the crew nacelle.

1-203. ENGINE OVERHEAT WARNING SYSTEM CONTROL SWITCHES. The engine overheat warning system is supplied with 28-volt direct current through an engine bay overheat circuit breaker switch (29, figure 1-4) on the engineer's switch panel. Two overheat circuits test switches (19, figure 1-4), for testing the operation of the engine overheat warning circuits, are located on the engineer's switch panel. When the test switches are moved to the "TEST" position, the engine overheat warning lights should light immediately.

1-204. ENGINE OVERHEAT WARNING LIGHTS. A row of six engine overheat warning lights (6, figure 1-5) on a panel behind the engineer's throttle quadrant and one engine overheat warning light (25, figure 1-19) on the pilot's instrument panel indicate excessive temperatures in the internal engine compartments or in the external

engine pods. The single warning light on the pilot's panel goes on when any of the warning lights is on at the engineer's station. The warning lights go on when engine compartment or pod temperatures reach 121°C (250°F) and go off when the temperatures drop below that figure. The overheat warning system is independent of the fire detection system, but the engine overheat warning lights will light if a fire occurs in one of the engine areas.

#### 1-205. ENGINE FIRE DETECTION SYSTEM.

1-206. Fire detector units, installed in the internal engine compartments and in the engine pods, are connected to fire indicator lights in the crew nacelle.

1-207. ENGINE FIRE DETECTION SYSTEM SWITCHES. The electrical circuits of the fire detection system are controlled by two fire detection circuit breaker switches (14, figure 1-4) on the engineer's switch panel. Operation of the fire detection circuits can be tested by the operation of six test switches (2, figure 1-28) on the fire extinguisher system control panel. When the test switches are moved to the test positions, the fire indicator lights should light within 15 seconds. The fire indicator light on the pilot's panel does not light when the test switches are used.

1-208. ENGINE FIRE INDICATOR LIGHTS. Six engine fire indicator lights (1, figure 1-28), one for each engine area, are mounted on the fire extinguisher system control panel at the engineer's station. One engine fire indicator light (2, figure 1-19) is installed on the pilot's instrument panel. When a sudden increase in temperature in an engine area reaches 399°C (750°F), the corresponding fire indicator light at the engineer's station goes on. The indicator light on the pilot's panel illuminates when any of the lights is on at the engineer's station.

#### 1-209. ENGINE FIRE EXTINGUISHER SYSTEM.

1-210. A methyl-bromide fire extinguisher system is provided for combating fires in the internal engine compartments. The system is divided into two parts, one for each side of the airplane. Each part is capable of combating two fires. The external pod engines are not provided with fire extinguisher systems. Controls for the fire extinguisher system are provided on the fire extinguisher system control panel at the engineer's station.

1-211. FIRE EXTINGUISHER DISCHARGE SWITCHES. One spring-loaded, three-position fire extinguisher discharge switch (3, figure 1-28) is provided for each internal engine compartment on the fire extinguisher system control panel at the engineer's station. When a fire extinguisher discharge switch is held in the up or "1ST FIRE" position, extinguishing agent is released in the corresponding engine compartment. Extinguishing agent may be released in the same compartment for a second fire by holding the switch to the down or "2ND FIRE" position. If the second fire is in the adjacent engine compartment, the corresponding discharge switch is held to the "2ND FIRE" position. The 28-volt dc supply to the fire extinguisher system is controlled and protected by a fire

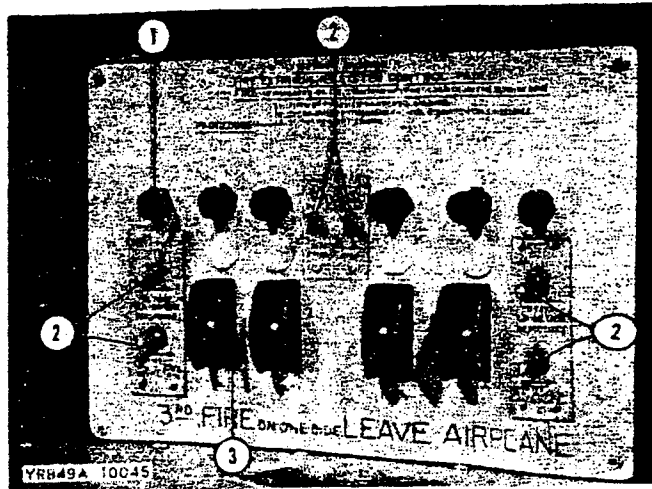

1. FIRE INDICATOR LIGHTS (6)
2. FIRE DETECTOR CIRCUIT TEST SWITCHES
3. FIRE EXTINGUISHER DISCHARGE SWITCHES (4)

Figure 1-28. Fire Extinguisher System Control Panel

extinguisher circuit breaker switch (30, figure 1-4) on the engineer's switch panel.

#### 1-212. MISCELLANEOUS EMERGENCY EQUIPMENT.

1-213. The locations of miscellaneous emergency equipment items are shown in figure 3-2.

1-214. HAND FIRE EXTINGUISHERS. Hand-operated fire extinguishers are located as follows: on the cabin wall just aft of the radio jacks, on the aft wall of the oxygen bottle well in the center crew nacelle section, and on the aft face of the forward wall of the aft compartment.

1-215. ALARM BELL SYSTEM. Alarm bells are installed at the navigator's station, at the engineer's station, in the center crew nacelle section, and in the aft crew nacelle section. The bells are rung by operation of an alarm bell switch on the beam above the pilot's pedestal. The alarm bell circuit is connected directly to the airplane battery and may be operated at any time.

1-216. FLARE PISTOL AND CARTRIDGES. The flare pistol and a case containing 20 flare cartridges are stowed in a container mounted on the radio shelf just forward of the dynamotor. A firing tube is installed in the top of the airplane over the radio shelves. When the pistol is mounted in the tube and fired, the flare is projected above and to the left of the airplane.

1-217. AXES. Crash axes are mounted on the bulkhead beside the radio operator's station and on the oxygen bottle well.

1-218. SIGNAL LAMP. A signal lamp, three colored filters and one neutral filter are stowed in a carrying case located forward

of the radar-navigator's station. An electric cord is attached to the lamp, and the lamp is operated by plugging the cord into a 28-volt receptacle in one of the heated clothing control boxes.

1-219. LIFE RAFTS. Two pneumatic, self-inflating life rafts, each provided with emergency provisions and equipment and an AN/CRT-3 emergency radio transmitter, are stowed in compartments in the upper wing surface near the landing flaps on each side of the nacelle. A CO<sub>2</sub> bottle attached to the door release mechanism in each compartment, operates to inflate the raft and eject it out of the compartment when the door is released.

1-220. LIFE RAFT RELEASE HANDLES. Life raft release handles are provided inside the crew nacelle and on the outside of each life raft compartment door. Inside the airplane, the two release handles (see figure 1-29) are located on the bulkhead just aft of the entrance hatch. Pulling out on these handles releases the compartment doors and actuates the CO<sub>2</sub> bottles to inflate and eject the life rafts. The outside handles are in recesses in the doors. The doors are released from the outside by lifting the handles and turning them counterclockwise, after which the doors must be lifted off. The CO<sub>2</sub> bottles may then be actuated by giving a quick pull on the short cables attached to them.

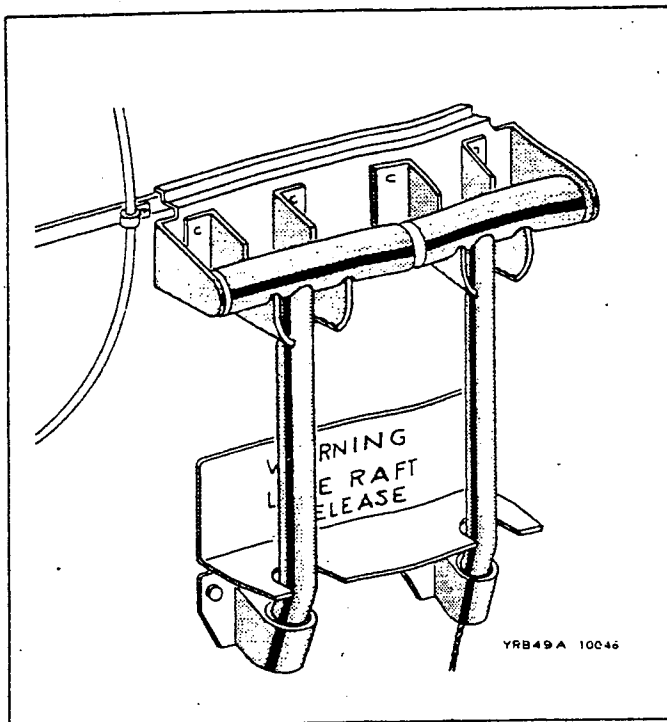

Figure 1-29. Life Raft Release Handles  
(On Bulkhead Aft of Entrance Hatch)

1-221. ENCLOSURE ESCAPE PANEL RELEASE CONTROLS. The overhead panel of the pilots' enclosure may be jettisoned by the operation of either of two enclosure escape panel release handles (1, figure 1-21; 3, figure 1-25) located under plastic covers at the left of the pilots. The escape panel may also be released by means of a handle on the outside of the enclosure.

In addition to the jettisonable entrance hatch and the enclosure escape panel, four escape hatches in the crew nacelle can be used as emergency exits. Three of the six exits can be used for escape in flight only, and three can be used for escape after ditching or forced landing. The following table lists the type, location, use, and operation of each emergency exit.

1-222. EMERGENCY EXITS. (See figure 3-1.)

EMERGENCY EXITS			
TYPE	LOCATION	USE	OPERATION
Enclosure escape panel	Forward compartment above pilot & co-pilot	1. Ditching 2. Forced landing 3. In flight	Pull jettison control handle - canopy lifts a few inches and is removed by airloads
Astrodome	Above radar-navigator	1. Ditching 2. Forced landing	Pull release cable - astrodome drops into cabin
Center compartment escape hatch	Center compartment, aft left side, above	1. Ditching 2. Forced landing 3. In flight	Turn locking handle - door drops into compartment
Forward escape hatch	Forward compartment floor, aft of co-pilot	In flight only	Turn both locking handles - door is jettisoned by own weight
Entrance hatch	Center compartment floor	In flight only	Pull out jettison handle connected to hinge pin and turn locking handles - door is jettisoned by own weight
Bomb bay escape hatch	Center compartment left side	In flight only	Turn "ON" any three bomb salvo switches, wait 10 seconds for bomb bay door to open and for bombs to drop, then lift door handle and turn clockwise - falls outboard through bomb bay

1-223. FIRST AID KITS. Two first aid kits are provided, one located above the radio operator's station and one on the forward wall of the oxygen tank well.

1-224. SEATS.

1-225. SEAT ADJUSTMENT CONTROLS. The pilot's, copilot's, and photo-navigator's seats are equipped with vertical adjustment levers. The pilot's and photo-navigator's seats also have fore-and-aft adjustment levers. When the vertical adjustment lever on the right-hand side of one of these seats is operated, the seat is raised by the action of spring bungees or lowered by the weight of the occupant. When the fore-and-aft adjustment lever on the aft left side of the pilot's or photo-navigator's seat is pulled back, the seat may be moved forward or aft in one-inch increments. The radar-navigator's, flight engineer's, and radio operator's seats can be rotated through 360° with eight stop positions equally spaced 45° apart. A lever on the right-hand side of each of these seats controls the setting of the rotary stop. The radar-navigator's seat is mounted on a carriage which rides on tracks, permitting fore-and-aft adjustment of the seat. A lever on the left-hand side of that seat controls the position of the seat on the tracks.

1-226. SHOULDER HARNESS INERTIA REEL LOCK CONTROL. A two position (locked - unlocked) shoulder harness inertia reel lock control is located on the left side of the pilot's and copilot's seats. A latch is provided for positively retaining the control handle at either position of the quadrant. By pressing down on the top of the control handle, the latch is released and the control handle may then be moved freely from one position to another. When the control is in the unlocked

position, the reel harness cable will extend to allow the pilot to lean forward in the cockpit; however, the reel harness cable will automatically lock when an impact force of 2 to 3 G's is encountered. When the reel is locked in this manner, it will remain locked until the control handle is moved to the locked and then returned to the unlocked position. When the control is in the locked position, the reel harness cable is manually locked so that the pilot is prevented from bending forward. The locked position is used only when a crash landing is anticipated. This position provides an added safety precaution over and above that of the automatic safety lock.

1-227. OPERATIONAL EQUIPMENT.

1-228. GENERAL.

1-229. Descriptions and operating instructions for the following operational equipment are included in Section IV:

- Photographic Equipment
- Photoflash Bombing Equipment
- Navigational Equipment
- Oxygen System
- Communication and Associated Electronic Equipment
- Air Conditioning System
- Lighting Equipment
- Ice Elimination Equipment
- Miscellaneous Operational Equipment



SECTION II  
NORMAL OPERATING INSTRUCTIONS

2-1. BEFORE ENTERING THE AIRPLANE.

2-2. RESTRICTIONS.

2-3. The following restrictions are subject to change and the latest service directives and orders must be consulted:

ITEM	RESTRICTION	LIMITS
Gross weight	maximum permissible	165,000 lbs. (Specific authorization must be obtained from Air Materiel Command to exceed this weight.)
	maximum for landing	150,000 lbs.
CG location	fuel loading	see paragraph 1-43
	range limits	see paragraph 2-6
Fuel temperature	maximum allowable for any flight	32.22°C (90°F)
Attitude on ground	maximum degrees nose up	3-1/2° (2-1/2° is normal)
Maneuver - flight	G-factor maximum limits	see figure 2-5
	acrobatics	prohibited
Airspeed	maximum level high speed	see figure 2-4
	maximum dive speed	see figure 2-4
Altitude	maximum allowable vs. fuel temperature	see figure B-2
Attitude in flight	maximum angle of yaw vs. speed	see figure B-1
Engine operation	minimum flight idling speed of internal engines for maximum control surfaces operation	57% of maximum rpm
Alternator and starter-generator loads	maximum permissible loads in flight	see figure B-3
	maximum permissible loads with engines idling on ground (alternators only)	25% of rated load
Landing gear operation	maximum speed for lowering gear (emergency release)	122 knots (IAS)
Landing flaps operation	maximum speed for extending flaps or with flaps extended	139 knots (IAS)
	maximum speed for raising flaps after landing	43 knots (IAS)

2-4. WEIGHT AND BALANCE.

2-5. Determine the take-off and anticipated landing gross weights and balance, and see that the airplane weight and balance Form F is complete. Refer to the Handbook of Weight and Balance, AN 01-1B-40, for loading information. Complete weight and balance charts, locating the cg under various loading conditions, are carried in the pilot's data case in the airplane.

WARNING

The cg location in this airplane is critically affected by the distribution of the fuel load. Fuel loading is described in paragraph 1-43 and in figure 1-7; restrictions on the quantities of fuel that may be carried are specified in paragraph 1-41; restrictions on the cg location range are specified in paragraph 2-6.

2-6. RESTRICTIONS ON CG RANGE LIMITS. The following table specifies the maximum permissible cg range limits for this airplane:

Landing Flaps Position	Maximum Permissible CG Range Limits	
	Normal Flying, Including Take-off and Landing, Not Exceeding Lift Coefficient of 1.1. (Flight speeds of not less than that for stall warning indication.)	Complete Stalls
UP	23 - 26	23 - 24
DOWN	23 - 26	23 - 24

Note: All cg positions are in terms of % MAC.

2-7. CREW REQUIREMENTS.

2-8. The minimum crew for this airplane includes: pilot, copilot, and engineer. Additional crew members, as required to accomplish special missions, may be added at the discretion of the Commanding Officer. The normal crew of five includes a photo-navigator and a radar-navigator. A photo-technician is also provided for, as a sixth crew member on photographic missions.

2-9. EXTERIOR INSPECTION.

2-10. Make the following checks and inspections before entering the airplane:

- a. Form 1 - Check for engineering status of airplane.
- b. Preflight maintenance and servicing - Check that airplane has been properly preflighted, including the following:

Fuel servicing

Oil, hydraulic fluid, and oxygen servicing

Engines inspected

Trim flaps inspected for free play

c. Protective covers - Check that all are removed.

d. Airplane general condition - Check the following:

Skin surface - Cleanliness; free of oil, heavy dust, or frost.

Skin seams - No apparent fluid leaks.

Control surfaces - Undamaged.

e. Wheel chocks - In place.

f. Tires and shock struts - Check condition.

g. Landing gear bungee air pressures - Check.

h. Nose gear doors bungee air pressure - Check.

i. Emergency air brake air bottle - Check.

j. Fuel load - Check that load distribution is proper; take average temperature of fuel.

NOTE

Fuel temperature must be lower than 32.22°C (90°F) for any flight.



Figure 2-1. Entrance to the Airplane (In Bottom of Center Crew Nacelle Section)

- k. Oil and hydraulic fluid - Check.
- l. Bomb bay door - Closed.
- m. Slot doors - Same position, both wings.
- n. Ground crew - Observer at nose gear.
- o. External dc starter power and external ac and ac airplane power supplies - Standby.
- p. Fire equipment - Standby.

- q. Danger areas - Clear.
- 2-11. ENTRANCE TO THE AIRPLANE.
- 2-12. The entrance hatch is located in the bottom center of the crew nacelle. (See figure 2-1.) The entrance ladder is normally stowed by strapping it to the aft face of the oxygen tank well in the center crew nacelle section.
- 2-13. ON ENTERING THE AIRPLANE.

---

2-14. STANDARD PREFLIGHT CHECK.

2-15. On entering the airplane, make the following preflight checks:

PILOTS

- a. Entrance and escape hatches - Closed and secured.
- b. Seat - Adjust and latch in position.
- c. Rudder pedals - Adjust.
- d. Bomb salvo switch - "OFF."
- e. Enclosure escape panel release handles - Forward.
- f. Oxygen equipment - Check system pressure, regulators and flow indicators operation.
- g. Nose wheel steering and hand brake handle - Full back.
- h. Instruments and indicators - Check for condition and markings.
- i. Altimeters and clocks - Set.
- j. Static pressure selector valves - "AIR-SPEED TUBE."
- l. Radios and interphone - Test operation.
- m. Gyros - Uncage.
- n. Wing slot open lights - On.
- o. Landing gear position indicator lights - Green light on.
- p. Circuit breakers - Reset.
- q. Rudder trim control knob - "0."

ENGINEER

- a. Landing flap emergency controls in aft crew nacelle section - Motor selector switches safetied in "ON" positions; reset lever straight down.
- b. Bomb salvo switches in center crew nacelle section - "OFF."
- c. Landing gear emergency release in center crew nacelle section - Handle straight down, ratchet selector lever in "LOCK GEAR" position, indicator at "GEAR LOCKED."
- d. Brakes and steering accumulator air pressure gage (forward of pilot's instrument panel) - Check pressure.
- e. Battery switch - "ON."
- f. Ac power control switches - External power breaker switch - "OPEN"; bus tie breaker switch, "OPEN"; voltage-frequency selector knob, "EXTERNAL POWER ON"; exciter control relay switches, "OFF."
- g. Ground crew interphone switch - "ON."
- h. Notify ground crew to connect external dc and ac airplane power.
- i. Ac external power voltage and frequency test switches - Hold to "TEST"; check voltage, cycles, and phase sequence on ac voltmeter, cycles indicator, and phase sequence indicator.
- j. Ac external power breaker switch - Trip to "CLOSE" if voltage, cycles, and phase sequence are proper.
- k. Notify pilot that power is on.
- l. Oxygen equipment - Check operation.
- m. Fuel counter indicators - Set.
- n. Fuel selector switches, fill tank switches, auxiliary to manifold switches - "OFF."
- o. Fuel level gages - Check indications against known quantities.
- p. Hydraulic brake pump manual override switch - "OFF."
- q. Static pressure selector valve - "AIR-

PILOTS

- r. Stall warning test switch - Hold to "TEST," and check horn and light operation.
- s. Wing slot switch - "OPEN"; check indicator lights.
- t. Landing gear warning silencer switches - "OFF."
- u. Auto-pilot master switch - "OFF."
- v. Enclosure escape panel release air bottle pressure gage - Check pressure.
- w. Throttles - Full back.
- x. Alarm bell switch - Test operation.

ENGINEER

SPEED TUBE."

- r. Indicators - Check; set altimeters and clock.
- s. Throttles - Closed.
- t. Generator switches - "ON."
- u. Circuit breakers and circuit breaker switches on upper half of switch panel (except pitot heater and battery heater switches) - Set to on positions.
- v. Anti-icing system switches - "OFF."
- w. Anti-icing systems circuit breaker - Reset.
- x. Altitude warning switch - "ON."
- y. Cabin air emergency shut-off switches - "ON."
- z. Overheat circuits test switches - Hold to "TEST" positions, check overheat warning lights for operation.
- aa. Flight control force scoop heater switch - "OFF."
- bb. Cabin air system switches - If pressurization desired: cabin air switch, "CABIN PRESSURE"; temperature selector switch, "AUTO."; temperature control rheostat, at desired setting. If pressurization not desired: cabin air switch, "RAM AIR"; temperature selector switch, "OFF."
- cc. Fire detection test switches - Hold to test positions; fire indicator lights must light within 15 seconds.

2-16. NIGHT PREFLIGHT CHECK.

2-17. For night flights or for day flights which will continue after sunset, the following preflight checks shall be made in addition to those outlined in the preceding paragraph:

- a. Bomb bay light - Check operation.
- b. Compartment dome lights - Check operation.
- c. Flashlight - Check operation.
- d. Cockpit lights, ultraviolet and red - Check operation.
- e. Navigation and fuselage lights - Have ground observers check operation of each light and report on interphone.
- f. Landing lights - Have ground observers check extension and illumination of lights and report on interphone.

2-18. FUEL SYSTEM MANAGEMENT.

2-19. GENERAL.

2-20. For normal operation, fuel from the auxiliary tanks is fed into the main tanks through the manifolds, and is then directed from the main tanks to the engines. In this manner, fuel that is farthest behind the center of gravity is used first. The auxiliary tank booster pumps are controlled by the auxiliary-to-manifold switches; the main tank booster pumps are automatically controlled by the fuel selector switches. Fuel control settings for take-off, climb, cruise, and landing are specified in the following paragraphs and in figure 2-2. Schematic fuel flow diagrams for take-off, climb, cruise, landing, transfer between main tanks, and crossfeed transfer are shown in figure 2-2. Fuel flow diagrams for emergency operation are shown in figure 3-3.

2-21. TAKE-OFF FUEL CONTROL SETTINGS.

- a. All fuel selector switches - "TANK TO MAN. & ENG."
- b. All auxiliary-to-manifold switches - "ON."

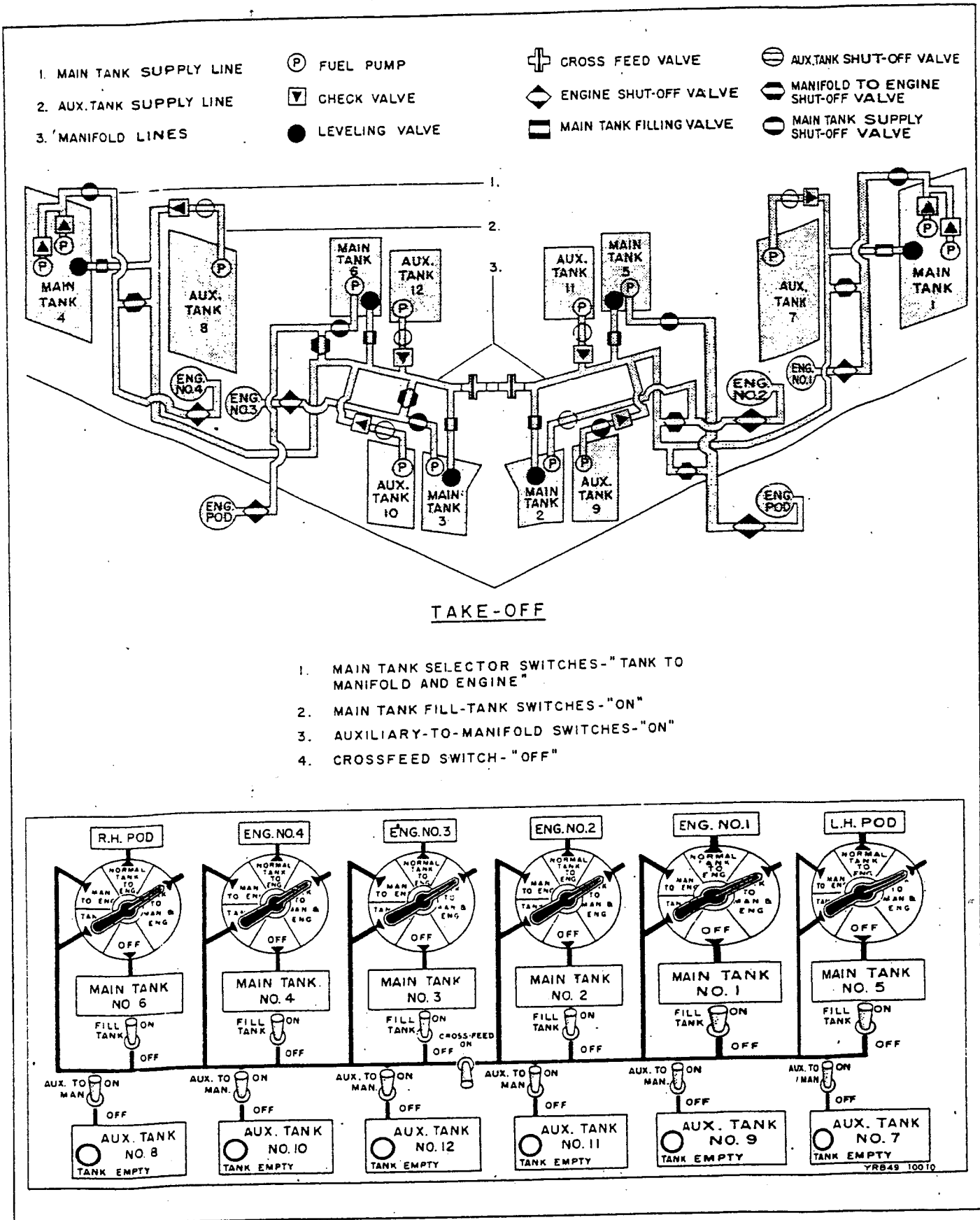
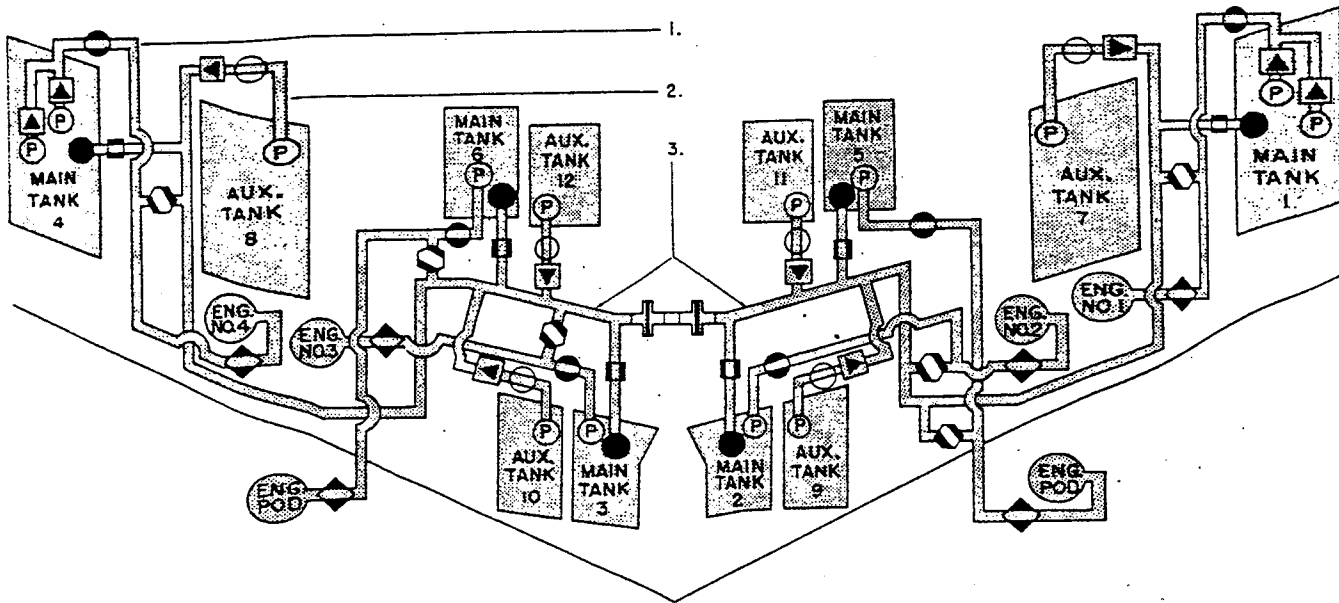

Figure 2-2 (Sheet 1 of 5 sheets). Courses of Fuel Flow

- |                          |                  |                           |                                     |
|--------------------------|------------------|---------------------------|-------------------------------------|
| 1. MAIN TANK SUPPLY LINE | (P) FUEL PUMP    | ⊕ CROSS FEED VALVE        | ⊖ AUX. TANK SHUT-OFF VALVE          |
| 2. AUX. TANK SUPPLY LINE | ▾ CHECK VALVE    | ◊ ENGINE SHUT-OFF VALVE   | ⊖ MANIFOLD TO ENGINE SHUT-OFF VALVE |
| 3. MANIFOLD LINES        | ● LEVELING VALVE | ▬ MAIN TANK FILLING VALVE | ⊖ MAIN TANK SUPPLY SHUT-OFF VALVE   |



CLIMB AND CRUISE

- |  |  |
|--|--|
| 1. MAIN TANK SELECTOR SWITCHES-"NORMAL TANK TO ENGINE" | 4. CROSSFEED SWITCH-"OFF"  |
| 2. MAIN TANK FILL-TANK SWITCHES-"ON"                   | 5. AS AUXILIARY TANKS BECOME EMPTY, TURN OFF AUXILIARY-TO-MANIFOLD SWITCHES  |
| 3. AUXILIARY-TO-MANIFOLD SWITCHES-"ON"                 | 6. WHEN ALL AUXILIARY TANKS ARE EMPTY, TURN OFF MAIN TANK FILL-TANK SWITCHES |

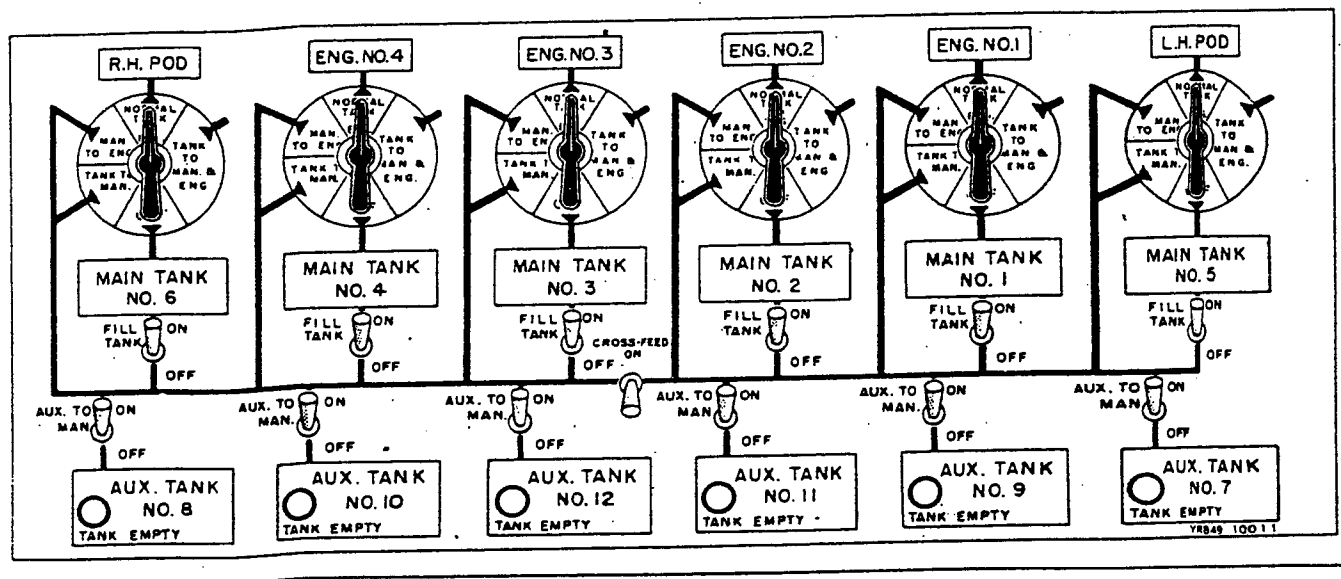

Figure 2-2 (Sheet 2 of 5 sheets). Courses of Fuel Flow

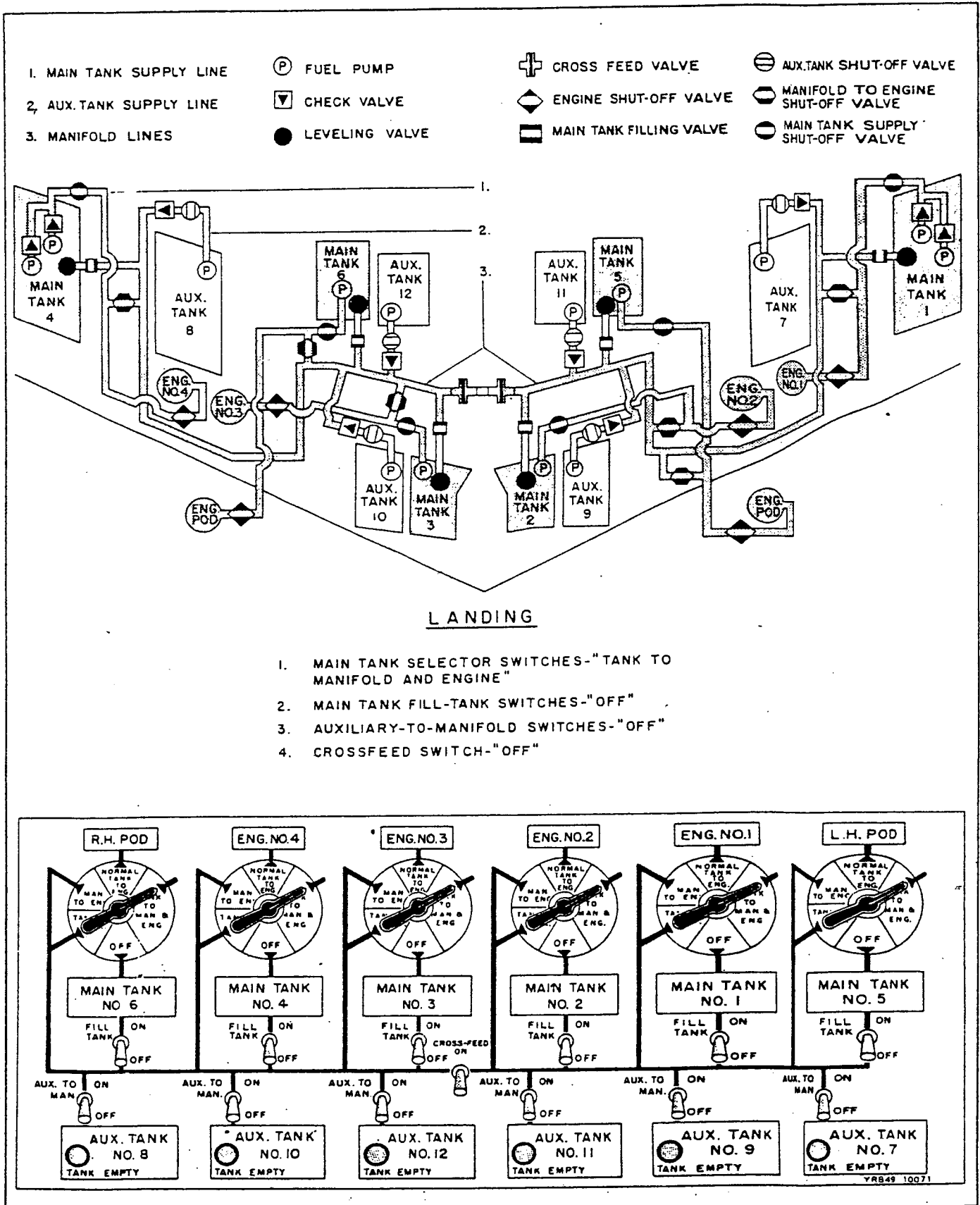
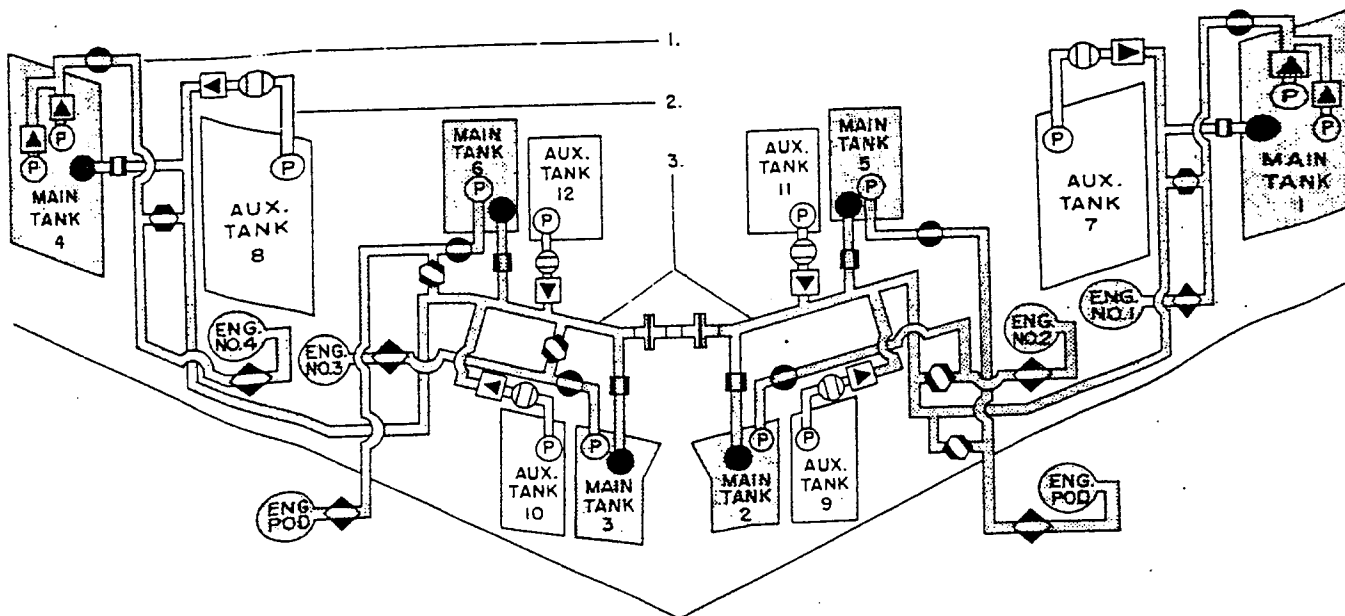

Figure 2-2 (Sheet 3 of 5 sheets). Courses of Fuel Flow

- 1. MAIN TANK SUPPLY LINE
  - 2. AUX. TANK SUPPLY LINE
  - 3. MANIFOLD LINES
- (P) FUEL PUMP
  - (∇) CHECK VALVE
  - (●) LEVELING VALVE
- (+) CROSS FEED VALVE
  - (◇) ENGINE SHUT-OFF VALVE
  - (■) MAIN TANK FILLING VALVE
  - (⊖) AUX. TANK SHUT-OFF VALVE
  - (⊖) MANIFOLD TO ENGINE SHUT-OFF VALVE
  - (⊖) MAIN TANK SUPPLY SHUT-OFF VALVE



TRANSFER BETWEEN  
ADJACENT MAIN TANKS

1. FOR TANK WHICH IS TO PROVIDE FUEL:  
A. SELECTOR SWITCH - "TANK TO MANIFOLD AND ENGINE"  
B. FILL-TANK SWITCH - "OFF"
2. FOR TANK WHICH IS TO RECEIVE FUEL:  
A. SELECTOR SWITCH - "NORMAL TANK TO ENGINE"  
B. FILL-TANK SWITCH - "ON"
3. AUXILIARY-TO-MANIFOLD SWITCHES - "OFF"
4. CROSSFEED SWITCH - "OFF"

NOTE: THIS PROCEDURE APPLICABLE WHEN A TANK IS RUPTURED BUT MECHANISMS ARE STILL OPERATIVE

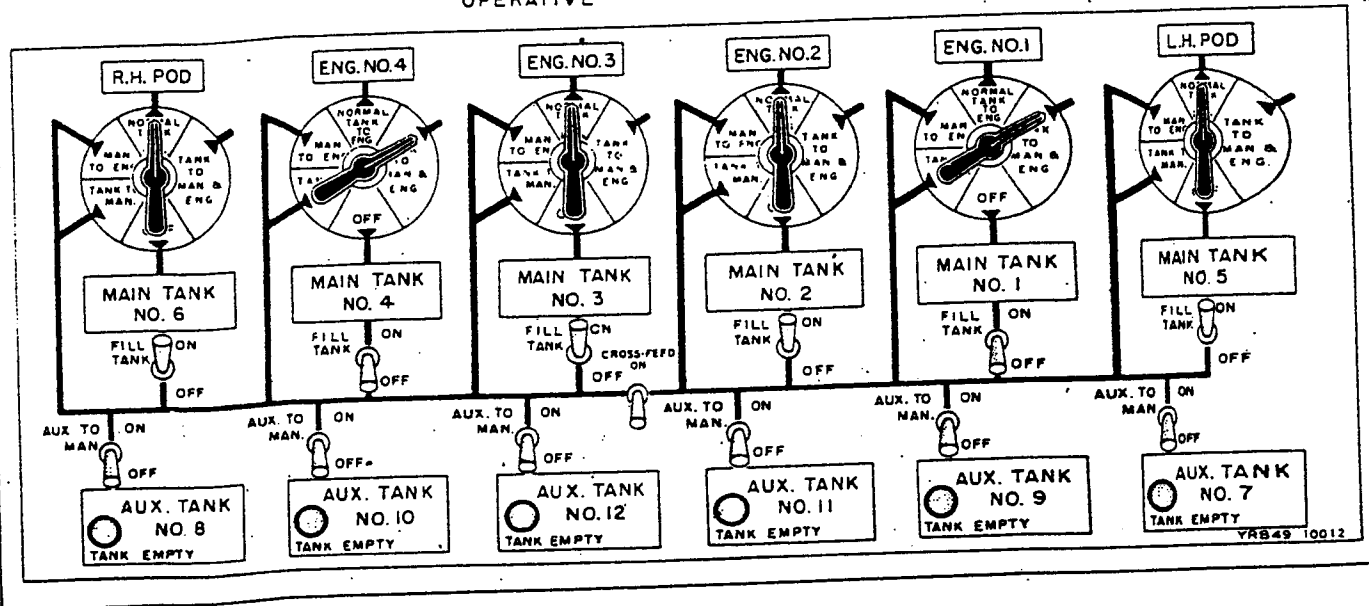
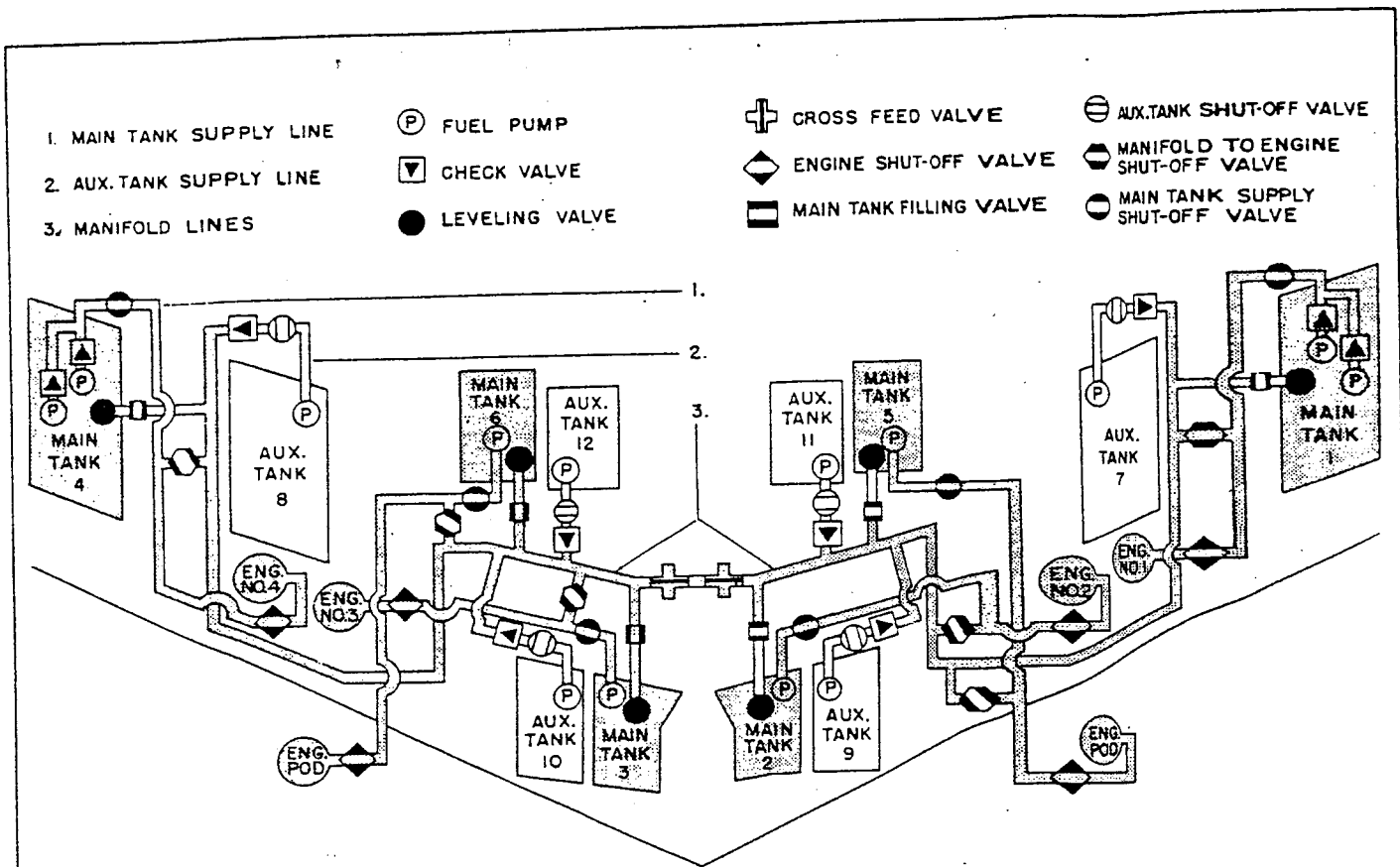

Figure 2-2 (Sheet 4 of 5 sheets). Courses of Fuel Flow





MAIN TANK CROSS TRANSFER

- |  |  |
|--|--|
| <p>1. FOR TANK WHICH IS TO PROVIDE FUEL:<br/>                 A. SELECTOR SWITCH-"TANK TO MANIFOLD AND ENGINE"<br/>                 B. FILL-TANK SWITCH-"OFF"</p> <p>3. AUXILIARY TO MANIFOLD SWITCHES-"OFF"</p> | <p>2. FOR TANK WHICH IS TO RECEIVE FUEL:<br/>                 A. SELECTOR SWITCH-"NORMAL TANK TO ENGINE"<br/>                 B. FILL-TANK SWITCH-"ON"</p> <p>4. CROSSFEED SWITCH-"ON"</p> |
|--|--|

NOTE: THIS PROCEDURE APPLICABLE WHEN A TANK IS RUPTURED BUT MECHANISMS ARE STILL OPERATIVE

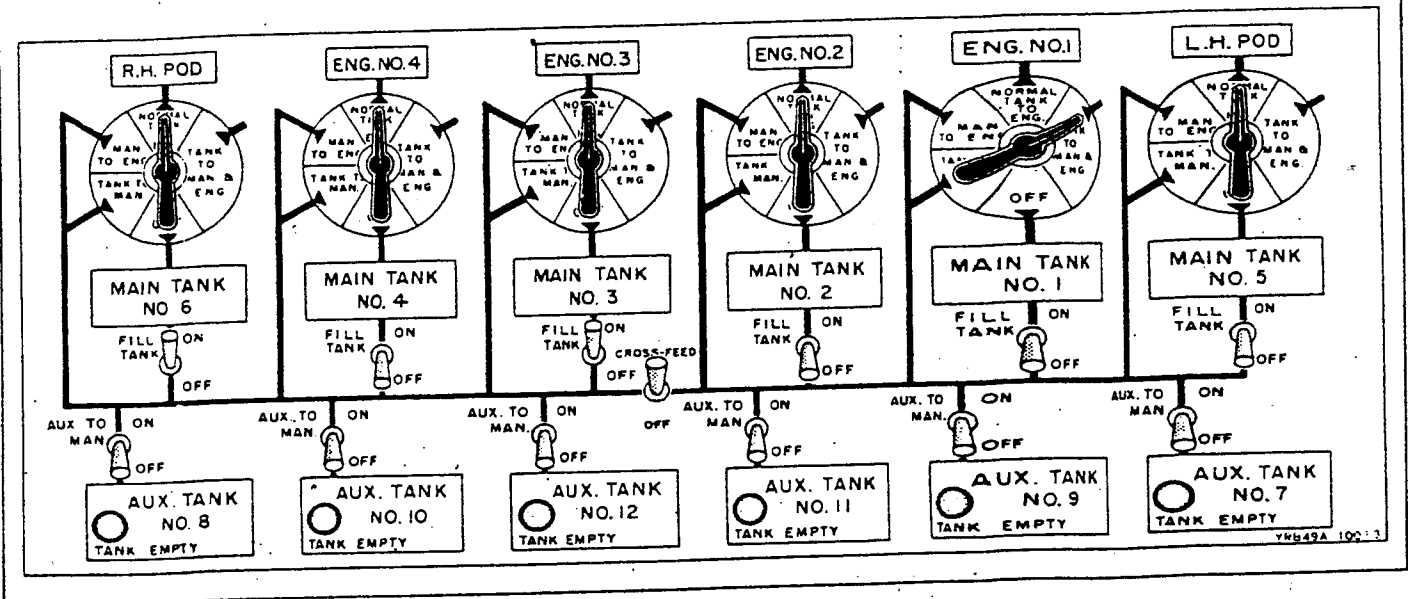

Figure 2-2 (Sheet 5 of 5 sheets). Courses of Fuel Flow

- c. All main tank fill-tank switches - "ON."
  - d. Cross-feed switch - "OFF."
- 2-22. CLIMB FUEL CONTROL SETTINGS.
- a. All fuel selector switches - "NORMAL TANK TO ENG."
  - b. All auxiliary-to-manifold switches - "ON."
  - c. All main tank fill-tank switches - "ON."
  - d. Cross-feed switch - "OFF."

NOTE

Set fuel controls for climb within 5 minutes after take-off.

2-23. NORMAL CRUISE FUEL CONTROL SETTINGS.

- a. All fuel selector switches - "NORMAL TANK TO ENG."
- b. All auxiliary-to-manifold switches - "ON."
- c. All main tank fill-tank switches - "ON."
- d. Cross-feed switch - "OFF."
- e. Auxiliary tanks will become empty approxi-

mately as follows:

- Nos. 9 and 10 - after 2 hours
- Nos. 11 and 12 - after 2-3/4 hours
- Nos. 7 and 8 - after 3-1/4 hours

f. As each auxiliary tank becomes empty and tank empty indicator light goes on, turn corresponding tank-to-manifold switch off. Main tanks only will supply fuel to engines after all auxiliary tanks are empty.

2-24. LANDING FUEL CONTROL SETTINGS.

- a. All fuel selector switches - "TANK TO MAN. & ENG."
- b. All auxiliary-to-manifold switches - "OFF."
- c. All main tank fill-tank switches - "OFF."
- d. Cross-feed switch - "OFF."

2-25. STARTING ENGINES.

2-26. GENERAL.

2-27. Before starting engines, make sure that the danger areas fore and aft of the airplane (see figure 2-3) are clear of personnel, aircraft, vehicles and ground equipment. External

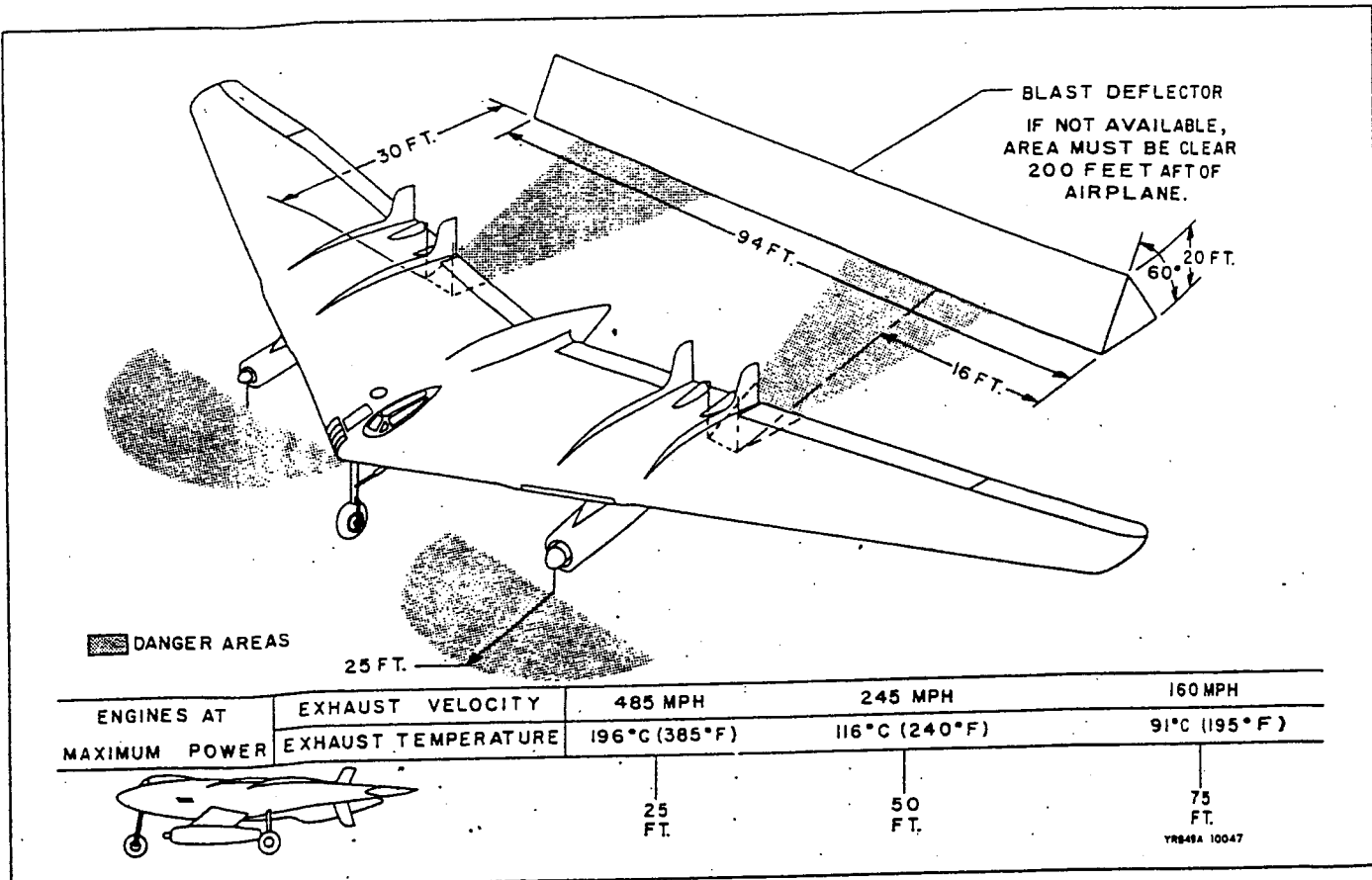

Figure 2-3. Danger Areas  
RESTRICTED

dc power must be plugged into the engine starting external power circuits on each side of the airplane for ground starting of the engines. External dc and ac power must also be plugged into the airplane's external power receptacles in the left wing. Refer to paragraph 3-18 for engine fire procedure.

than one minute. Starter motor will safely provide only three immediately consecutive starts or starting attempts, with minimum intervals of 3-minutes rest between starts. Each series of three starts or attempted starts must be followed by a 30-minute period during which the starter is not operated.

2-28. ENGINE STARTING PROCEDURE (ENGINEER).

- a. External dc starter power - Plugged in.
- b. Fuel selector switch for engine to be started - "NORMAL TANK TO ENG."
- c. Starter switch for engine to be started - "NORMAL START"; hold momentarily, then release.

e. Exhaust temperature gage - Check for indication of start and note that temperature is below limit mark.

f. Engine speed - 50% rpm ground idling speed is required to provide adequate ac and dc power.

g. Oil pressure - At least 7 psi after engine has stabilized at idle speed.

NOTE

After moving starter switch to "NORMAL START" and releasing, current is supplied automatically to that engine's starter and ignition system for 45 seconds. If it is necessary to stop the starting procedure during that time, move the starter switch to "EMER. STOP."

2-29. HOT STARTS OR ACCELERATION.

2-30. Record each "hot start" in Form 1. A "hot start" is defined as a start (1) during which the tailpipe temperature exceeds 900°C (1652°F) but is under 1000°C (1832°F) for a period of 20 seconds or longer, or (2) during which the temperature reaches 1000°C (1832°F) or higher for a period of 10 seconds or longer.

2-31. After five starts in which the temperature is between 900°C (1652°F) and 1000°C (1832°F) for a period of 20 seconds or longer or one start in which the temperature exceeds 1000°C (1832°F) for a period of 10 seconds or longer, a special inspection of the engine must be made by the ground crew.

2-32. If overspeeding of 102% to 104% is encountered during any start and/or acceleration, the engine will be inspected. An overspeeding at any time in excess of 104% will require the engine to be inspected.

- d. Throttle lever for engine to be started - When engine reaches 8% rpm, move throttle lever smoothly but rapidly to idle range. The engine will require 5 to 8 seconds to fire.

CAUTION

If engine does not fire within 10 seconds after throttle is moved to idle position, stop engine and allow at least 5 minutes for fuel to drain from combustion chambers before again attempting to start engine. Do not operate starter continuously for more

2-33. AFTER ALL ENGINES ARE STARTED.

PILOTS

ENGINEER

NOTE

Operation of control surfaces and wing slot doors must be checked by ground observers reporting direction and amount of movement on interphone.

a. Elevons and control sticks - Check freedom, direction, and amount of movement on normal and emergency power.

b. Rudders and pedals - Check freedom and amount of movement.

c. Wing slot doors - Check operation; check indicator lights; leave wing slot switch in "OPEN" position.

d. Landing flaps - Check operation; check indicator.

e. Trim flaps and control wheels - Check freedom, direction, and amount of movement on normal and emergency power; check trim indicators. After check, leave trimmed nose up, as

a. Engines - Operate at 60% rpm, to provide hydraulic pressure for control surface operation.

b. Fuel selector switches - "TANK TO MAN & ENG."

c. Fill tank switches - "ON."

d. Auxiliary to manifold switches - "ON."

e. Hydraulic pressures - Check.

PILOTS

ENGINEER

Required. (0° to 3° normal range with cg of 25% to 26%.)

f. Auto-pilot and rudder trim - Check operation.

f. Ac voltage-frequency selector knob - On desired alternator.

g. Exciter control relay switch for alternator to be put on line - "ON."

h. Check voltage and cycles of alternator on voltmeter and cycles indicator.

i. External power breaker switch - "OFF."

j. Alternator breaker switch - "CLOSE"; check indicator light.

k. Repeat f., g., and h. for second alternator; check synchronization lights.

l. Alternator breaker switch for second alternator - "CLOSE"; check indicator light.

m. Indicators - Check.

n. Generators - Check and adjust voltages.

o. Notify ground crew to disconnect external power and remove wheel chocks.

p. Ground crew interphone switch - "OFF."

q. Notify pilot when ready to taxi.

2-34. TAXIING.

2-35. GENERAL.

2-36. Limit ground operating time to a minimum, as the six engines consume up to 25 gallons of fuel per minute at taxiing rpm.

2-37. TAXIING PRECAUTIONS.

a. Do not turn the nose wheel with the airplane stationary.

b. Use extreme caution when making turns. Do not turn nose wheel sharply. Do not force nose wheel to turn; use only a follow-up motion with the steering handle.

c. Landing gear side load structural limitations are: 0.3 "G" side load at 146,500 pounds or more gross weight, and 0.5 "G" side load

at 146,500 pounds or less gross weight.

2-38. USE OF BRAKES.

2-39. Either pilot can use the brake pedals to apply the brakes. For minimum radius turns at slow speeds, use differential braking. If the airplane gains excessive speed while taxiing, the brakes can be applied evenly on both main gear by pulling back on the nose wheel steering and hand brake handle. Use of the hand brake during taxiing should be limited to braking or stopping in a straight line.

2-40. USE OF THROTTLES.

2-41. Advance the throttles slowly and evenly for taxi thrust. Engine speeds of 60% to 70% rpm are necessary to initiate the roll; after the airplane is moving, 50% rpm is sufficient to keep it moving, except on an uphill grade.

2-42. BEFORE TAKE OFF.

PILOTS

ENGINEER

a. Airplane in position for take-off.

b. Hand brake - Set.

c. Wing slot switch - "OPEN."

d. Landing flap switch - "OFF"; check position indicator for up position.

e. Throttle levers - When ready for take-off, check with engineer and advance throttle levers to full open position.

f. Hand brake - Release, after receiving engineer's O.K. for take-off.

e. Engine indicators - Check readings when pilot advances throttles and, if normal, give pilot O.K. for take-off.

2-43. TAKE-OFF.

2-44. TAKE-OFF CHARACTERISTICS.

2-45. The airplane will fly off with gentle back-pressure on the stick. The airspeed at which it leaves the ground depends on the gross weight. As the airplane leaves the ground, a sensation of being in an excessively nose-high attitude may be experienced by the pilots. This sensation arises from the fact that the pilots are seated in the wing rather than in a fuselage positioned at several degrees of incidence below the chord-line of the wing.

2-46. DIRECTIONAL CONTROL DURING TAKE-OFF.

2-47. On the take-off run, directional control is maintained first with the steerable nose wheel and then, as the speed increases, with the rudders. Do not use the brakes except in an emergency.

2-48. NORMAL TAKE-OFF PROCEDURE.

a. After the engineer has given the O.K. for take-off, release the parking brake but continue to hold the nose wheel steering and hand brake handle for steering purposes. Keep the nose wheel on the ground with full forward pressure on the control stick. The copilot will call out airspeeds so that the pilot may devote all of his attention to the runway.

NOTE

Approximately 19 seconds time is required for the engines to accelerate from 32% rpm to 100% rpm.

b. At 65 to 75 knots the rudders become effective. When that speed is reached, release the nose wheel steering and hand brake handle and return the control stick to about neutral. Raise the nose wheel at the following airspeeds:

GROSS WEIGHT	AIRSPEED
175,000	99 knots (IAS)
145,000	90 knots (IAS)
115,000	81 knots (IAS)

c. Lift the airplane off the ground by gentle back pressure on the stick at the following airspeeds:

GROSS WEIGHT	AIRSPEED
175,000	109 knots (IAS)
145,000	101 knots (IAS)
115,000	90 knots (IAS)

d. As soon as the airplane is airborne, brake the wheels with the foot pedals and retract the gear. Maintain an airspeed just at

the stall warning indication until unaccelerated flight occurs, or until obstacles are cleared.

WARNING

The airspeed must be held below 152 knots until the gear is up and the doors are locked. Approximately one minute is required for full retraction of the gear.

e. When safe altitude and airspeed have been reached, retard the throttles for climb at normal rated power.

f. Place the wing slot switch in the "AUTO" position.

2-49. MINIMUM RUN TAKE-OFF PROCEDURE.

2-50. Use the same procedure as for a normal take-off.

2-51. ENGINE FAILURE DURING TAKE-OFF. (See paragraphs 3-4 through 3-9.)

2-52. CLIMB.

2-53. NORMAL CLIMB.

2-54. Normal rated power (96% rpm) or military power (100% rpm) may be used for climbs. Use of military power is limited to 30 minutes duration. See figure A-8, Appendix I, for climb speeds. During the climb, the engineer should synchronize the engine rpm's and, within 5 minutes after take-off, change the fuel selector switch settings to "NORMAL TANK TO ENG."

2-55. Several types of climbs, each optimum with respect to a different criterion, are possible. These climbs are those requiring minimum time, minimum fuel, or minimum distance, respectively, to reach each particular altitude, or that providing maximum distance including cruise distance from end of climb for the fuel consumed. The operating instructions (see figure A-8) relating to these climbs include airspeed and power.

2-56. For minimum time climb (maximum rate of climb), the airspeeds are the same as those tabulated in the climb chart (see figure A-8). Continuous use of military power is optimum for this type climb.

2-57. For minimum fuel climb, the exact airspeeds have not been determined. However, for airplanes of this type, minimum time climb airspeeds provide almost minimum fuel climb. Therefore, the airspeeds tabulated in the climb chart (see figure A-8) are suitable and are recommended. Using military power is optimum, as is evident in the performance data.

2-58. For maximum distance climb, the exact airspeeds have not been determined. However, for airplanes of this type, maximum distance climb is almost attained with minimum time climb airspeeds. Thus, the climb airspeeds tabulated in the climb chart (see figure A-8) are recommended. Continuous use of military

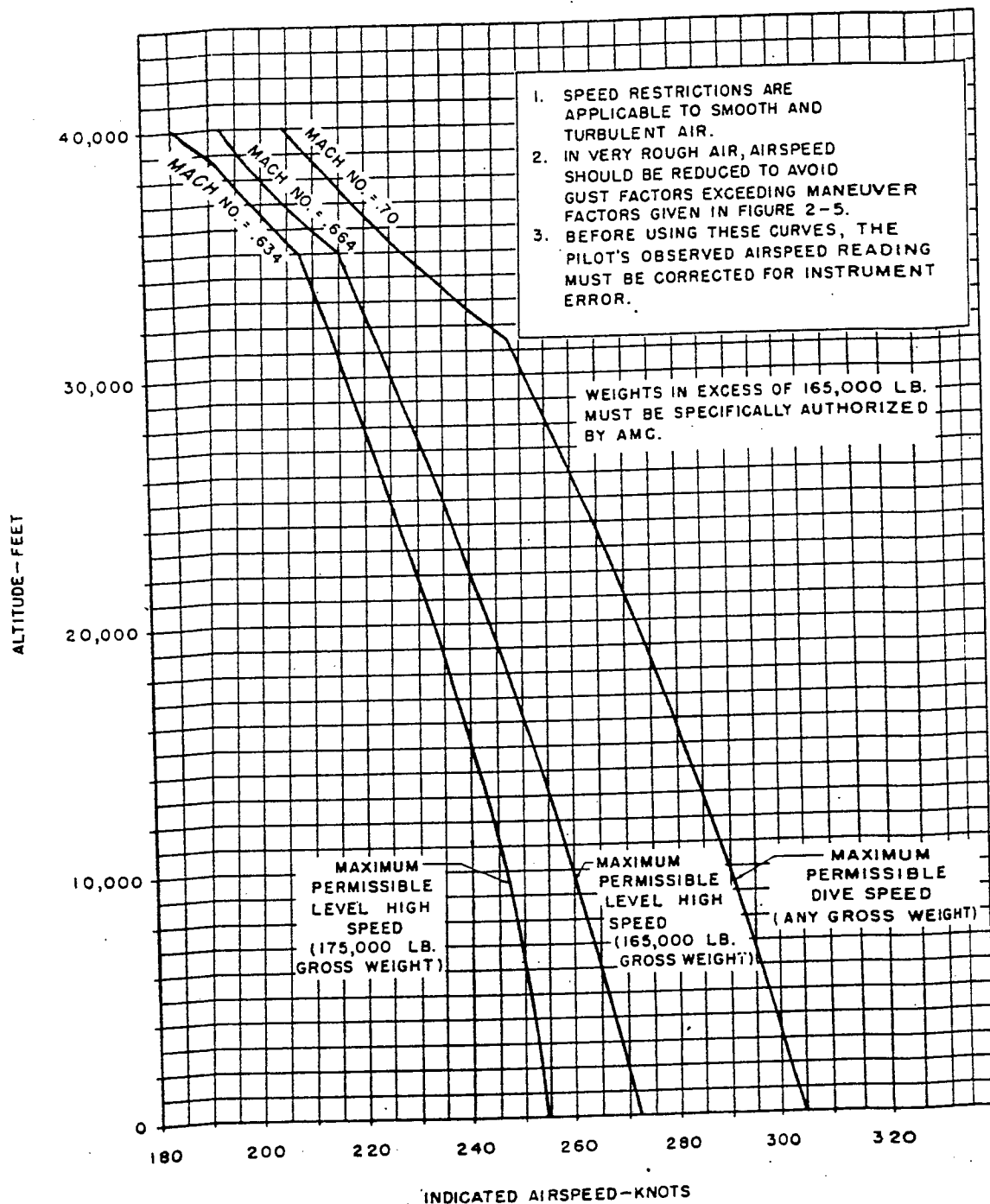

78849A 10019

Figure 2-4. Dive and High Speed Restrictions

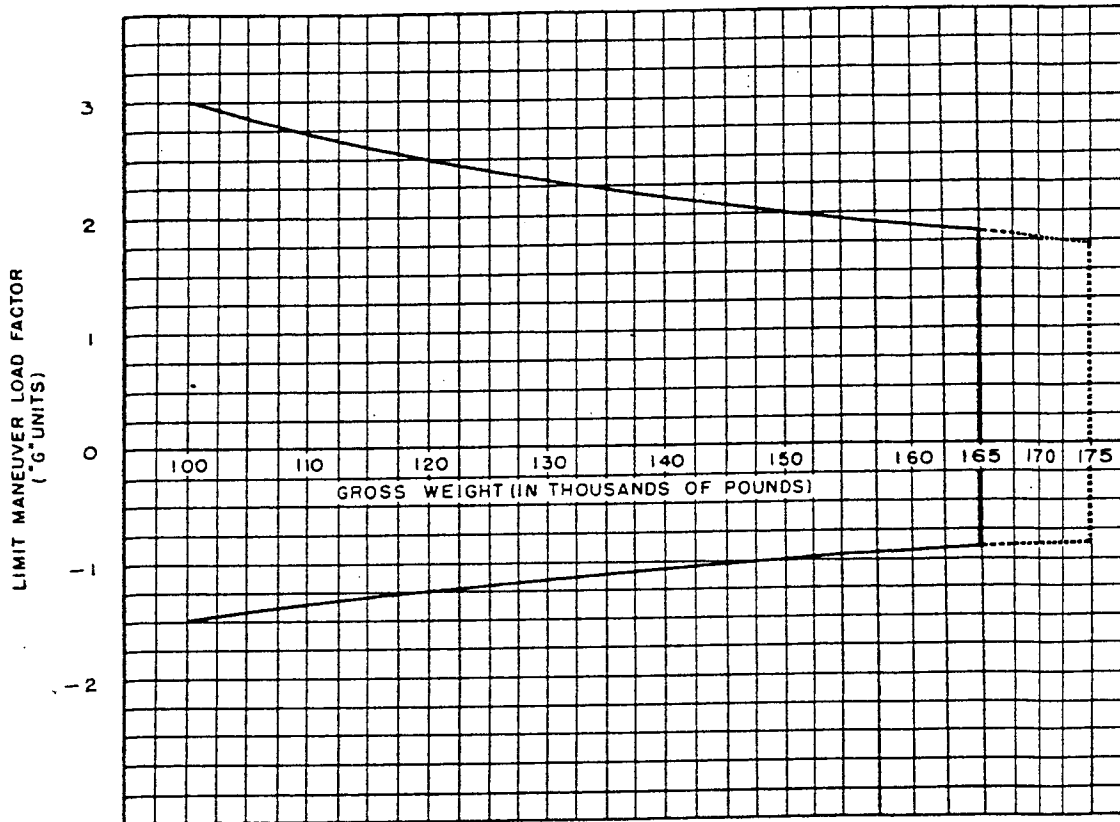

**CAUTION**  
GUST LOAD FACTORS EXCEEDING THESE  
MANEUVER LIMITS SHOULD BE AVOIDED  
BY AIRSPEED REDUCTION IN VERY ROUGH  
AIR.

WEIGHTS ABOVE 165,000 LBS. MUST  
BE SPECIFICALLY AUTHORIZED BY AIR  
MATERIEL COMMAND.

YRB49A 10020

Figure 2-5. Flight Maneuver Load Factor Restrictions

power is almost optimum for this type climb and is recommended.

2-59. OBSTACLE CLIMB.

2-60. Clearing obstacles on the climb-out after take-off should be done with an airspeed at least 18 knots above the minimum take-off speed and slightly above the speed at which the stall warning is actuated, to avoid control difficulties.

2-61. DURING FLIGHT.

2-62. GENERAL.

2-63. Use pitot heat and flight control force scoop heater as necessary. When on a photographic mission, do not change the cabin air temperature controls from the settings initially made by the photo-navigator. As the auxiliary fuel tanks become empty, turn off the corresponding auxiliary-to-manifold switches.

2-64. ENGINE OPERATION.

2-65. Throttle operation is conventional. Operate the throttles slowly and smoothly, especially when flying above 10,000 feet, to avoid flame-out. The minimum engine rpm for maximum operation of the power surface control hydraulic systems is 57%. Above 17,000 feet altitude, minimum engine rpm's must be increased to above flame-out, as indicated below:

Altitude (Feet)	Minimum Engine Rpm
Sea Level	57%
10,000	57%
20,000	62%
30,000	72%
35,000	75%

2-66. WING SLOT DOORS OPERATION CHARACTERISTICS.

2-67. As the wing slot doors close, the airplane noses down momentarily and then returns to its original trim.

2-68. CONTROL SURFACES OPERATION.

2-69. To obtain maximum control surfaces operating speed for simultaneous use of elevons, rudders and trim flaps, maintain internal engine rpm's above 57% of maximum. (Pod engines do not have hydraulic pumps.) If the internal engine speeds are reduced to less than 57% rpm, the maximum control surfaces speed available is reduced in direct proportion. At low airspeeds, lateral and longitudinal control is adequate but directional control is impaired.

2-70. FLIGHT DATA AND RESTRICTIONS.

2-71. CRUISE CONTROL DATA. (See Appendix I.)

2-72. LEVEL HIGH SPEED RESTRICTIONS. (See figure 2-4.)

2-73. MANEUVER LOAD ("G") RESTRICTIONS. (See figure 2-5.)

2-74. ALTITUDE RESTRICTIONS. (See figure B-2.)

2-75. YAW VS. AIRSPEED RESTRICTIONS. (See figure B-1.)

2-76. CG RANGE RESTRICTIONS. (Refer to paragraph 2-6.)

2-77. ALTERNATOR AND STARTER-GENERATOR LOAD RESTRICTIONS. (See figure B-3.)

2-78. STALLS.

2-79. STALL SPEEDS.

2-80. Stall speed varies, depending on the gross weight and the cg location. When the airplane cg is rearward, a stall is more violent and the airplane tends to drop off into a spin. An airspeed of at least 18 knots above the stall speed should be maintained at all times.

STALL SPEEDS					
IAS - KNOTS					
GEAR UP OR DOWN			IDLING POWER		
FLAP POSITION	ANGLE OF BANK	GROSS WEIGHT-1000 lbs			
		175	145	115	85
0°	0°	102	93	84	73
0°	30°	108	100	90	78
50°	0°	97	90	80	70
50°	30°	104	95	86	74

2-81. STALL INDICATIONS.

2-82. There is little if any pre-stall buffeting. The stall warning horn and light on the beam above the pilot's pedestal are automatically actuated at approximately 13 knots above the stalling speed.

2-83. STALL RECOVERY.

2-84. Recovery from a stall is made by moving the stick forward and using elevon control to prevent roll. Wind tunnel tests indicate that the use of rudder control retards the recovery.

2-85. SPINS.

2-86. GENERAL.

2-87. Intentional spins are prohibited in this airplane. There is no tendency for the airplane to spin inadvertently in either the cruising or landing attitudes. A roll from a stall may develop into a spin, especially when the cg location is rearward.

2-88. SPIN CHARACTERISTICS.

2-89. Although spin test data have not been compiled for this airplane, wind tunnel tests indicate that a spin would be very steep, with some oscillation, and with the airplane losing about 1800 feet altitude per turn.



2-90. SPIN RECOVERY.

2-91. Wind tunnel tests show that recovery from a spin may be effected in approximately 2-1/2 turns by moving the control stick forward and reversing the stick laterally, leaving the rudders with the spin. The tests indicated that reversing the rudders retarded recovery.

2-92. ACROBATICS.

2-93. All acrobatics are forbidden in this airplane.

2-94. DIVING.

2-95. GENERAL.

2-96. The maximum allowable airspeeds for diving are shown in figure 2-4. Abrupt pull-outs at high speeds shall be avoided.

2-97. APPROACH.

2-98. GENERAL.

2-99. The landing flaps on this airplane lower the stall speed only slightly, but they appreciably steepen the glide path of the airplane. If, during the approach, it becomes necessary to reduce the airspeed without flattening the glide path, the rudders may be opened simultaneously. This procedure should be used with caution until the pilot is familiar with the characteristics of the airplane in order to avoid dropping the airplane in at a high rate of descent. The trim flaps are used to trim out the negative pitch moment caused by lowering the flaps.

2-100. The following checks shall be made during the approach:

PILOTS

- a. Landing gross weight and cg location - Check with engineer.
- b. Command radio - On.
- c. Wing slot doors switch - "OPEN."
- d. Auto-pilot - Off.
- e. Landing gear - Lower at 152 knots or less.
- f. Brakes and steering hydraulic pressure - Check with engineer.
- g. Landing flaps - Lower at 139 knots or less.
- h. Trim flaps - Set nose up, as necessary.
- i. Airspeed "over the fence" -

GROSS WEIGHT	AIRSPEED
150,000 lbs.	113 knots (IAS)
125,000 lbs.	104 knots (IAS)
100,000 lbs.	94 knots (IAS)

2-101. LANDING.

2-102. GENERAL.

2-103. The landing technique for this airplane is the same as that for any airplane equipped with tricycle landing gear. The airplane has a tendency to float during the landing because of the large area of the wing and its proximity to the ground. During the transition from the steady glide to landing, the airspeed is maintained slightly above the stall warning indication speed to attain the minimum horizontal distance.

2-104. NORMAL LANDING.

2-105. As soon as the nose wheel is on the ground, hold the stick forward and operate the nose wheel steering and hand brake handle for directional control. The brakes can be applied by operation of the brake pedals or by pulling back on the nose wheel steering and hand brake handle. Do not raise the landing flaps until the airplane's speed has dropped below 43 knots (IAS).

2-106. CROSSWIND LANDING.

2-107. Normal technique for this type of airplane is used for crosswind landing. The effect of a crosswind on the airplane after touch-down is less than that experienced with other airplanes because this airplane has no fuselage or tail.

2-108. MINIMUM RUN LANDING.

2-109. The landing run can be shortened by having the engineer cut the four internal engines after touch-down, by opening both rudders, and by using full flaps.

ENGINEER

- a. Landing gross weight and cg location - Calculate; check with pilot.
- b. Electrical systems - Check.
- c. Power surface control hydraulic pressures - Check.
- f. Nose gear steering hydraulic pressure - Check, after gear is down. Notify pilot that pressure is O.K.
- g. Fuel selector switches - "TANK TO MAN. & ENG."

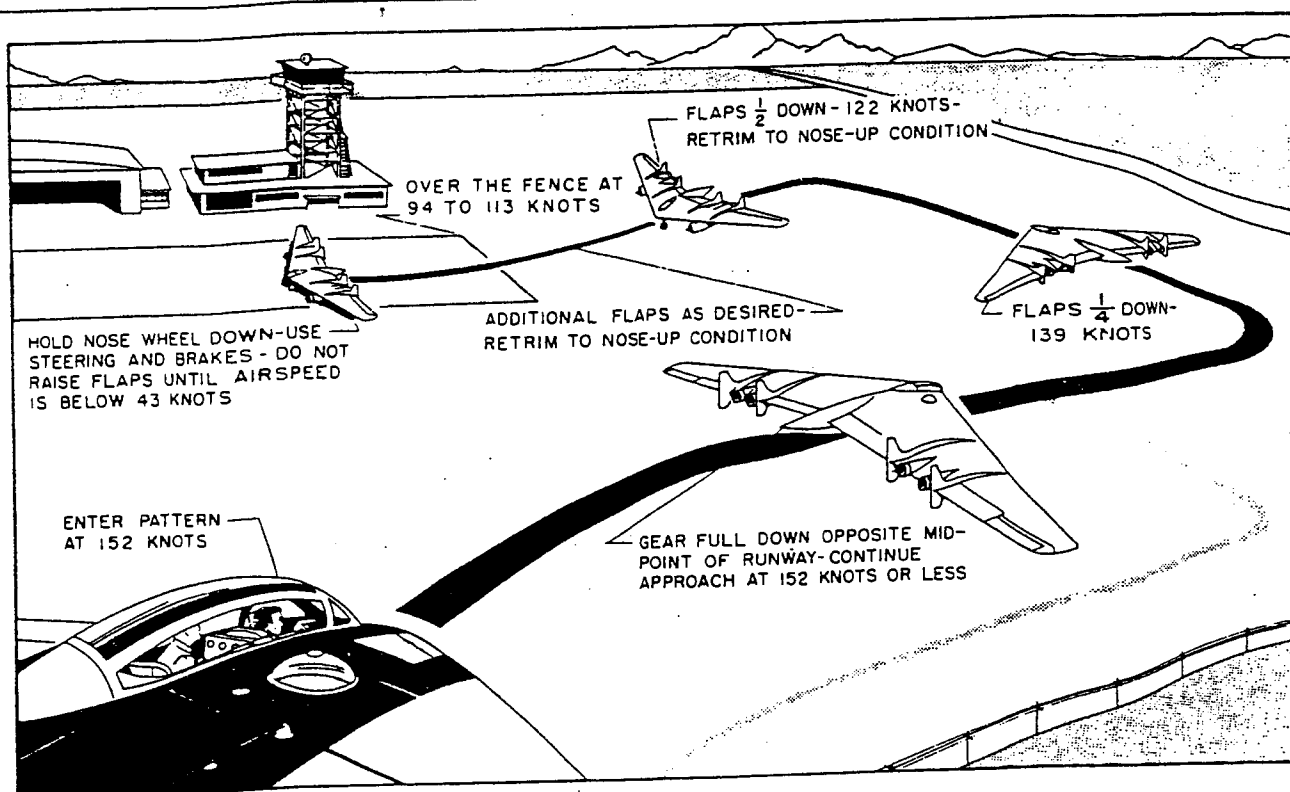

Figure 2-6. Approach Pattern

2-110. GO-AROUND.

2-111. Advance the throttles, close the rudders (if open), and re-trim the airplane. Raise the landing flaps and the gear when the

airplane is clear of the ground. Maintain an airspeed of less than 152 knots until the gear is up and the doors are closed and locked. Then assume a normal climbing angle.

2-112. STOPPING ENGINES.

PILOTS

ENGINEER

a. Throttles - Retarded.

b. Flight controls - Move all surfaces to neutral, landing flaps up; notify engineer.

c. Gyros - Cage.

c. Throttles - Move individual throttle levers past idle detents to "CLOSED" positions.

d. Fuel selector switches - "OFF," after engines have stopped.

CAUTION

Do not turn fuel selector switches off until engines stop rotating; otherwise, engine-driven fuel pumps will be running while dry.

2-113. BEFORE LEAVING THE AIRPLANE.

PILOTS,

ENGINEER

a. Brakes - Set by pulling nose wheel steering and hand brake handle full back and releasing trigger.

a. All fuel system switches - "OFF."

PILOTS

ENGINEER

CAUTION

Do NOT set brakes if they are hot.

- b. Lights - Off.
  - c. Radios - Off.
  - d. Brakes - When wheel chocks are in place, release nose wheel steering and hand brake handle to its forward position.
  - e. Fill out Form 1.
- b. All ac power control switches - "OFF" and "OPEN."
  - c. Generator switches - Leave "ON."
  - d. All circuit breaker switches on upper half of switch panel - "OFF."
  - e. Battery switch - "OFF."

RESTRICTED  
AN 01-15EBB-1

RESTRICTED

SECTION III  
EMERGENCY OPERATING INSTRUCTIONS

3-1. ENGINE FAILURE.

3-2. GENERAL.

3-3. In all cases of engine failure, the flight engineer shall turn the fuel selector switch for that engine to "OFF" and close the individual throttle. Fuel remaining in the main tank corresponding to that engine may be transferred to the other main tanks or fed to the other engines through the manifold. (See figures 2-2 and 3-3.)

3-4. ENGINE FAILURE BEFORE LEAVING THE GROUND ON TAKE-OFF.

3-5. In the event of engine failure during the take-off run:

- a. If flying speed has been reached, continue the take-off, using rudder to control the yaw, if necessary.
- b. If flying speed has not been reached or it is decided that obstacles can not be cleared, retard the throttles and apply the brakes as much as is possible without skidding the tires.
- c. It is possible to retract the landing gear before the airplane's weight is off the gear by pulling out on the landing gear handle emergency release knob, (29, figure 1-20) on the left side of the pilot's pedestal and then moving the landing gear handle to the "UP" position.

3-6. ENGINE FAILURE AFTER LEAVING THE GROUND ON TAKE-OFF - CONTINUED FLIGHT.

3-7. In the event of engine failure after the airplane has left the ground on take-off, if sufficient airspeed and power to continue flight have been attained:

- a. Retract landing gear.
- b. If possible, maintain at least the optimum airspeed for minimum drag, as follows:

GROSS WEIGHT	AIRSPEED
175,000	171 knots (IAS)
145,000	157 knots (IAS)
115,000	140 knots (IAS)

c. Allow airplane to yaw up to permissible limits shown in figure B-1 in order to permit closing of rudders. This procedure will give minimum drag and allow airplane to be more easily controlled.

NOTE

The yaw stabilizer system will

automatically open the opposite rudder enough to compensate for the unbalanced thrust. It will be necessary to re-trim the airplane for yawed flight by operation of the rudder trim control knob.

3-8. ENGINE FAILURE AFTER LEAVING THE GROUND ON TAKE-OFF - FORCED LANDING.

3-9. In the event of engine failure after the airplane has left the ground on take-off, if sufficient airspeed and power to continue flight have not been attained:

- a. Determine whether the circumstances and the time available make it desirable or practical to attempt to lower the gear. Approximately one minute is required for the landing gear to retract or extend; the direction of travel of the gear can be reversed at any time by moving the landing gear handle to the opposite position.
- b. Lower the flaps.
- c. Notify the engineer to close the individual throttles.
- d. If sufficient altitude is available, salvo the photoflash bombs, if installed. Approximately 10 seconds are required for the bomb bay door to open and the photoflash bombs to drop.
- e. Instruct crew members to prepare for forced landing.
- f. Jettison the enclosure escape panel.
- g. Lock shoulder harnesses; copilot's, pilot's, and photo-navigator's seats.

CAUTION

The pilot, copilot, and photo-navigator are prevented from bending forward when the controls are in the locked positions; therefore all switches not readily accessible should be cut before moving the controls to the locked positions.

h. Land straight ahead, changing direction only enough to miss obstacles.

3-10. ENGINE FAILURE DURING FLIGHT.

3-11. If an engine fails during flight:

- a. Follow procedure specified in paragraph 3-7, steps b and c.
- b. Increase power on remaining engines to

maintain desired airspeed and altitude. (Do not exceed normal operating restrictions, including those listed in paragraph 2-3.)

3-12. FLYING WITH ONE OR MORE ENGINES INOPERATIVE.

3-13. When flying with one or more engines inoperative:

a. Stalling airspeeds, with various combi-

3-14. EMERGENCY AIR STARTING OF ENGINES.

PILOTS

ENGINEER

a. Pull nose of airplane up momentarily to drain combustion chambers of engine to be started.

b. Engine rpm (windmilling) - At least 8%.

nations of engines inoperative, are approximately the same as normal stalling speeds (see paragraph 2-80).

b. It is safe to turn into a dead engine if adequate airspeed is maintained or if the power on the operating engines is not too high.

c. For maximum range, the airplane should be permitted to yaw sufficiently to allow closing of the rudders (see paragraph 3-7, c).

b. Throttle - Closed.

c. Fuel selector switch - Turn to "NORMAL TANK TO ENGINE."

d. Engine starting switch - Hold to "AIR START" position momentarily.

e. Throttle - Open smoothly and rapidly to idle range.

f. Exhaust temperature gage - Observe for indication of start.

g. If starting attempt is unsuccessful, close throttle and repeat procedure.

h. Engine rpm - Allow engine to operate at retarded power setting until exhaust temperature stabilizes.

i. Synchronize engine rpm with that of other engines.

3-15. FIRE.

3-16. ENGINE FIRE.

3-17. GENERAL. The engine overheat warning lights indicate overheat and possible fire conditions in the internal engine compartments

or in the external engine pods. When an engine overheat warning light goes on, under any circumstances, decrease the power on that engine and watch the fire indicator lights on the fire extinguisher system control panel for further indication of fire.

3-18. ENGINE FIRE DURING STARTING.

PILOTS

ENGINEER

e. Alert crew in case airplane has to be evacuated.

a. Starter switch - Move to "EMER STOP" position.

b. Fuel selector switch - Turn "OFF."

c. Notify ground crew by interphone.

d. Notify pilot.

e. Fire extinguisher discharge switch (internal engine only) - Hold to "1ST FIRE" position for 6 seconds.

f. Throttle - Close.

3-19. ENGINE FIRE DURING FLIGHT.

PILOTS

c. Alert crew to stand by in case airplane has to be abandoned.

d. If fire is in external engine pod, attempt to put fire out by sideslipping airplane away from fire.

e. Give order to bail out, in event fire cannot be extinguished.

ENGINEER

- a. Fuel selector switch - Turn "OFF."
- b. Inform pilot which engine is afire.

c. Fire extinguisher discharge switch (internal engine only) - Hold to "1ST FIRE" or "2ND FIRE" position for 6 seconds.

NOTE

Fire indicator light will go out when fire is out.

d. Throttle - Close.

e. Do not restart that engine.

f. If smoke or fumes enter crew nacelle through cabin pressurization system, move cabin air emergency shut-off switch for that side of airplane to "OFF" position (25, figure 1-4).

3-20. WING FIRE.

3-21. In the event of a fire occurring outside of the internal engine compartments, attempt to put the fire out by sideslipping the airplane away from the fire. Turn off corresponding cabin air emergency shut-off switch (25, figure 1-4) if smoke or fumes enter crew nacelle.

3-22. CREW NACELLE FIRE.

3-23. If a fire occurs in the crew nacelle:

a. See that all hatches are secure.

b. If ram air is being used for ventilation, move cabin air switch (21, figure 1-4) to "CABIN PRESSURE" position.

c. Move cabin air emergency shut-off switches (25, figure 1-4) to "OFF" positions.

d. Use hand-operated fire extinguishers.

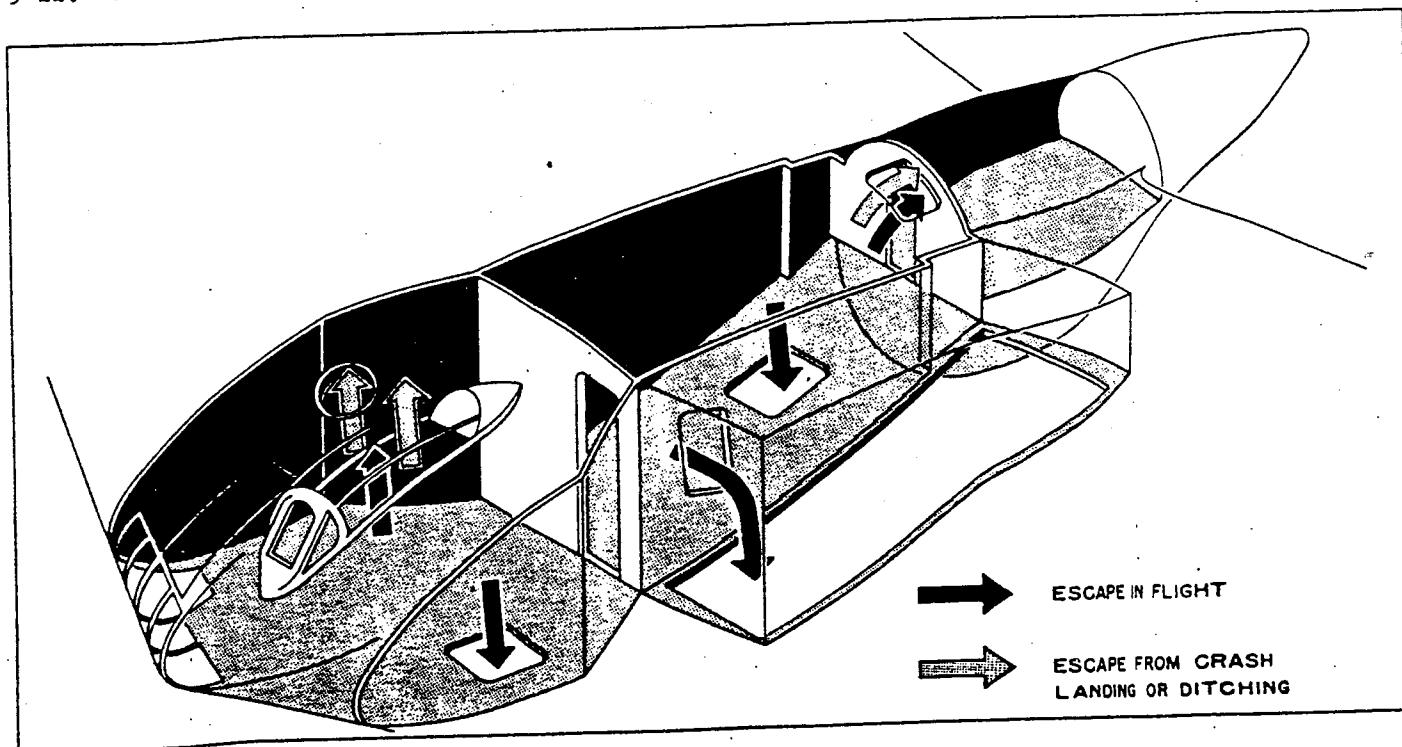

Figure 3-1. Emergency Exits

3-24. BAIL-OUT.

3-25. GENERAL.

3-26. Emergency exit for the pilots is through the top section of the enclosure. Any of the three hatches in the floor of the crew nacelle or the escape hatch into the bomb bay can be used by other crew members for emergency exit from the airplane during flight. (See figure 3-1.) The escape hatch into the bomb bay is the largest and offers the jumper the most safety in clearing the airplane. Instructions for releasing the escape hatches are stenciled

on the hatches. Depressurize the crew nacelle by moving the cabin air switch (21, figure 1-4) on the engineer's switch panel to its "EMER DUMP" position before attempting to open the escape hatches. Before opening the escape hatch into the bomb bay, operate one of the bomb salvo switches (9, figure 1-21; 22, figure 4-5), located to the left of the pilot's station, on the radar-navigator's switch panel, and on the center crew nacelle section wall beside the escape hatch. Wait 10 seconds after operating the bomb salvo switch (time for the bomb bay door to open and for the photoflash bombs to drop), then open the escape hatch into the bomb bay.

3-27. BAIL-OUT PROCEDURE.

PILOTS

- a. Give crew bail-out warning by interphone and three short rings of alarm bell.
- b. Contact ground stations by radio, giving necessary information.
- d. If airplane is carrying photoflash bombs, salvo them "safe" over an unpopulated area.
- e. Instruct crew members to open lower escape hatches and bomb bay escape hatch, and to take first aid kits.
- f. Give location and time of bail-out to ground radio stations.
- g. Give command to abandon airplane by interphone and one long ring of alarm bell.
- h. Pull back enclosure escape panel release handle.
- i. Bail out through top of enclosure.

CREW MEMBERS

- b. Prepare for bail-out.
- c. Radar-navigator - Check that bomb nose fuse arming switch is in "SAFE" position.
- d. Engineer - Place cabin air switch in "EMER DUMP" position.
- f. Open escape hatches as directed by pilot.
- h. Check gear and bail out, as instructed by pilot.

3-28. FORCED LANDINGS.

3-29. LANDING WITH GEAR RETRACTED.

3-30. If it is necessary to make a wheels-up landing, proceed as follows:

- a. Give crew forced-landing warning by interphone and six short rings of alarm bell.
- b. If airplane is carrying photoflash bombs, salvo them "safe" over unpopulated area.
- c. If feasible, circle landing area to use up excessive fuel.
- d. Release all oxygen by turning the regulators to the extreme clockwise position.
- e. Have astrodome and upper escape hatch in center crew nacelle section removed.
- f. Jettison enclosure escape panel.
- g. Lock shoulder harnesses; copilot's, pilot's, and photo-navigator's seats.

CAUTION

The pilot is prevented from bending forward when the control is in the locked position; therefore, all switches not readily accessible should be "cut" before moving the control to the locked position.

- h. Lower full flaps.
- i. Hold power on until the airplane has reached landing attitude just above stalling speed, then have engineer retard throttles to closed positions just prior to landing.
- j. Have engineer turn generators and alternators off.
- k. Warn crew with one long ring of alarm bell to brace themselves for impending impact.
- l. After landing, turn battery switch off.
- m. After airplane has come to rest, leave it immediately. Make sure that all crew members are out; then move to a safe distance



from the airplane.

3-31. EMERGENCY EXITS AFTER FORCED LANDING.

3-32. For emergency exit on the ground, the overhead escape panel of the pilots' enclosure can be released by operation of one of the release controls (1, figure 1-21; 3, figure 1-25), located at the left of each pilot's seat; the astrodome can be released (inward) by pulling the emergency release cord adjacent to it; and the upper escape hatch in the aft compartment can be released. If conditions do not permit use of the exits mentioned, emergency escape can be made by cutting holes with the crash axes in certain areas of the aft crew nacelle section which are stenciled as emergency escape areas.

3-33. DITCHING.

3-34. GENERAL.

3-35. Ditching characteristics of this type airplane have not been definitely established. Tests with scale models have given the following indications of what may be expected in ditching: The best attitude for contact seems to be a normal landing attitude, with the landing gear up and the landing flaps down and at the lowest possible forward speed. Upon contact, especially if one wing is low, the model tests indicate a tendency to yaw, and near the end of the run a moderate turn may develop. Neither the yaw nor the turn appears to be dangerous, but crew members should be braced to withstand

both longitudinal and lateral deceleration. No specific ditching stations have been established for the crew members, as the space available on the aft sides of the compartment bulkheads is limited.

3-36. DITCHING PROCEDURE.

- a. Give crew ditching warning by interphone and six short rings of alarm bell.
- b. If airplane is carrying photoflash bombs, salvo them "safe."
- c. Have astrodome and upper escape hatch in crew nacelle center section removed.
- d. Jettison enclosure escape panel.
- e. Lock shoulder harnesses; pilot's, copilot's, and photo-navigator's seats.
- f. Lower full flaps.
- g. Hold power on until airplane has reached landing attitude just above stalling speed, then have engineer retard throttles to closed positions just before contact.
- h. Have engineer turn off generators, alternators, and battery switches.
- i. Warn crew with one long ring of alarm bell to brace themselves for impending impact.
- j. As soon as airplane stops moving, have

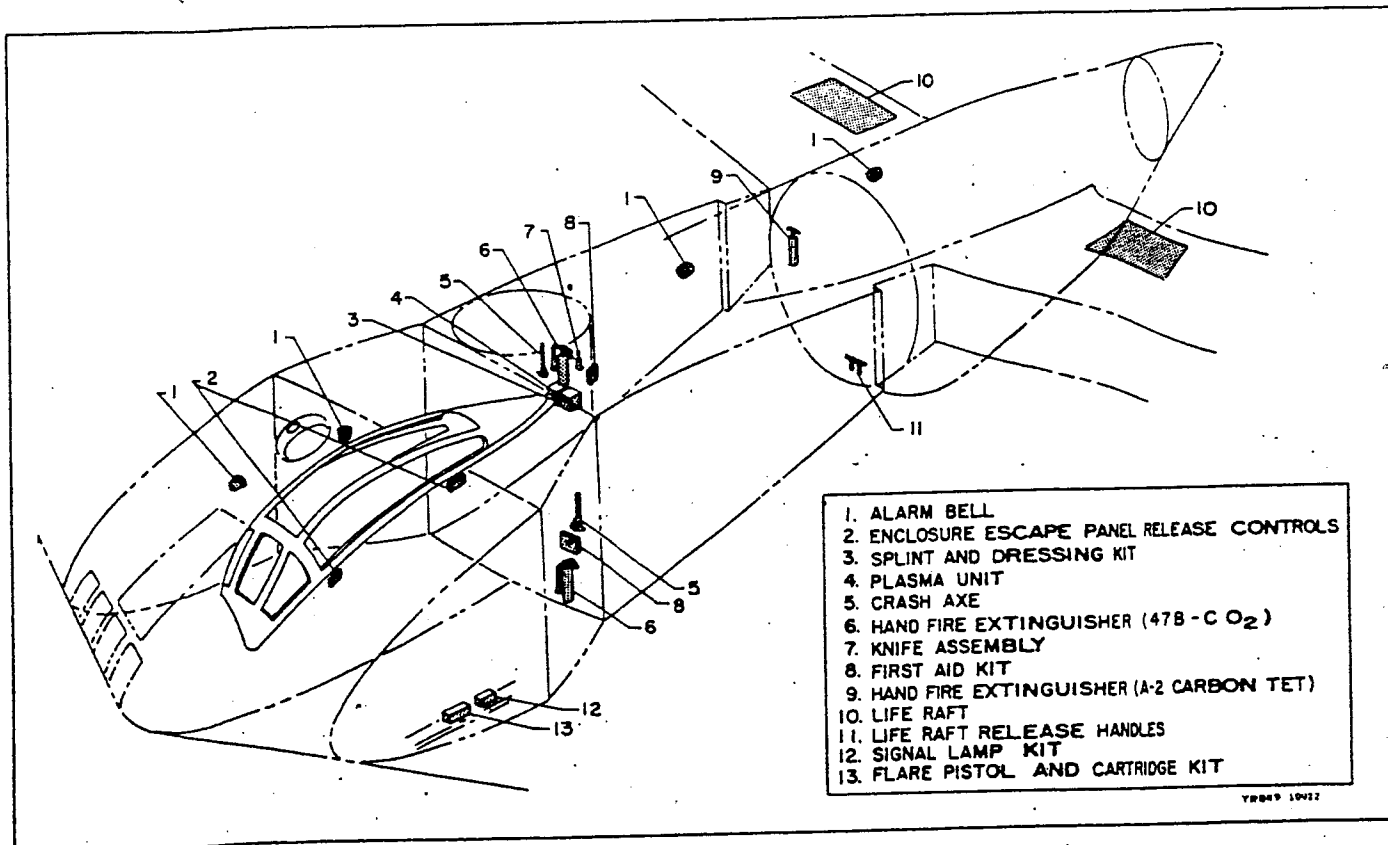
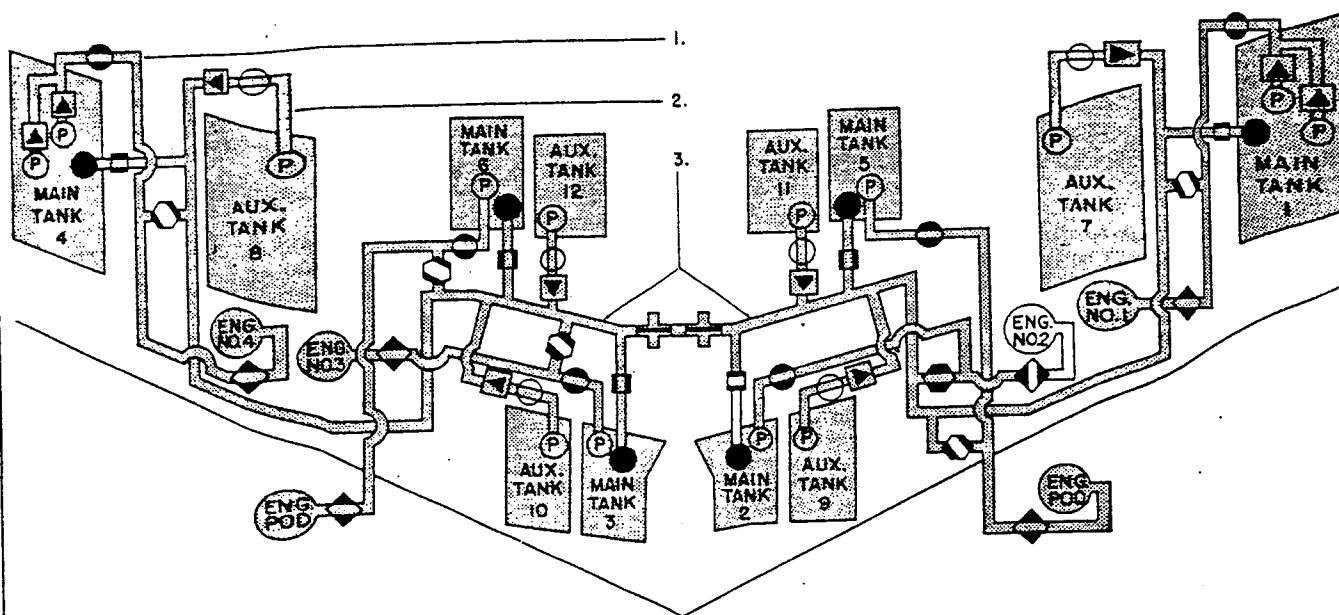

Figure 3-2. Miscellaneous Emergency Equipment

- |                          |                  |                           |                                     |
|--------------------------|------------------|---------------------------|-------------------------------------|
| 1. MAIN TANK SUPPLY LINE | (P) FUEL PUMP    | ⊕ CROSS FEED VALVE        | ⊖ AUX. TANK SHUT-OFF VALVE          |
| 2. AUX. TANK SUPPLY LINE | ▽ CHECK VALVE    | ◇ ENGINE SHUT-OFF VALVE   | ⊖ MANIFOLD TO ENGINE SHUT-OFF VALVE |
| 3. MANIFOLD LINES        | ● LEVELING VALVE | ▢ MAIN TANK FILLING VALVE | ⊖ MAIN TANK SUPPLY SHUT-OFF VALVE   |



**ENGINE FAILURE**

- AFFECTED ENGINE SELECTOR SWITCH - "TANK TO MANIFOLD"
- CORRESPONDING MAIN TANK FILL-TANK SWITCH - "OFF"
- OTHER MAIN TANK SELECTOR SWITCHES - "NORMAL TANK TO ENGINE"
- OTHER MAIN TANK FILL-TANK SWITCHES - "ON"
- AUXILIARY-TO-MANIFOLD SWITCHES - "ON"
- CROSSFEED SWITCH - "ON"
- WHEN MAIN TANK FOR INOPERATIVE ENGINE BECOMES EMPTY, TURN SELECTOR SWITCH "OFF" AND CROSS-FEED SWITCH "OFF"

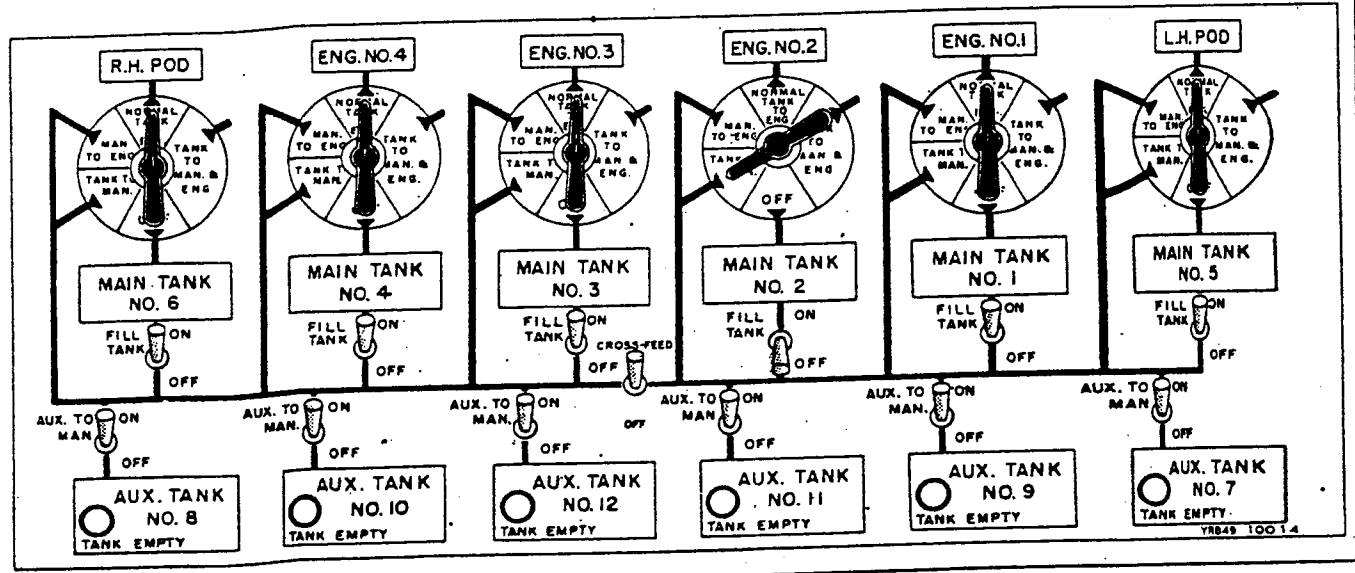
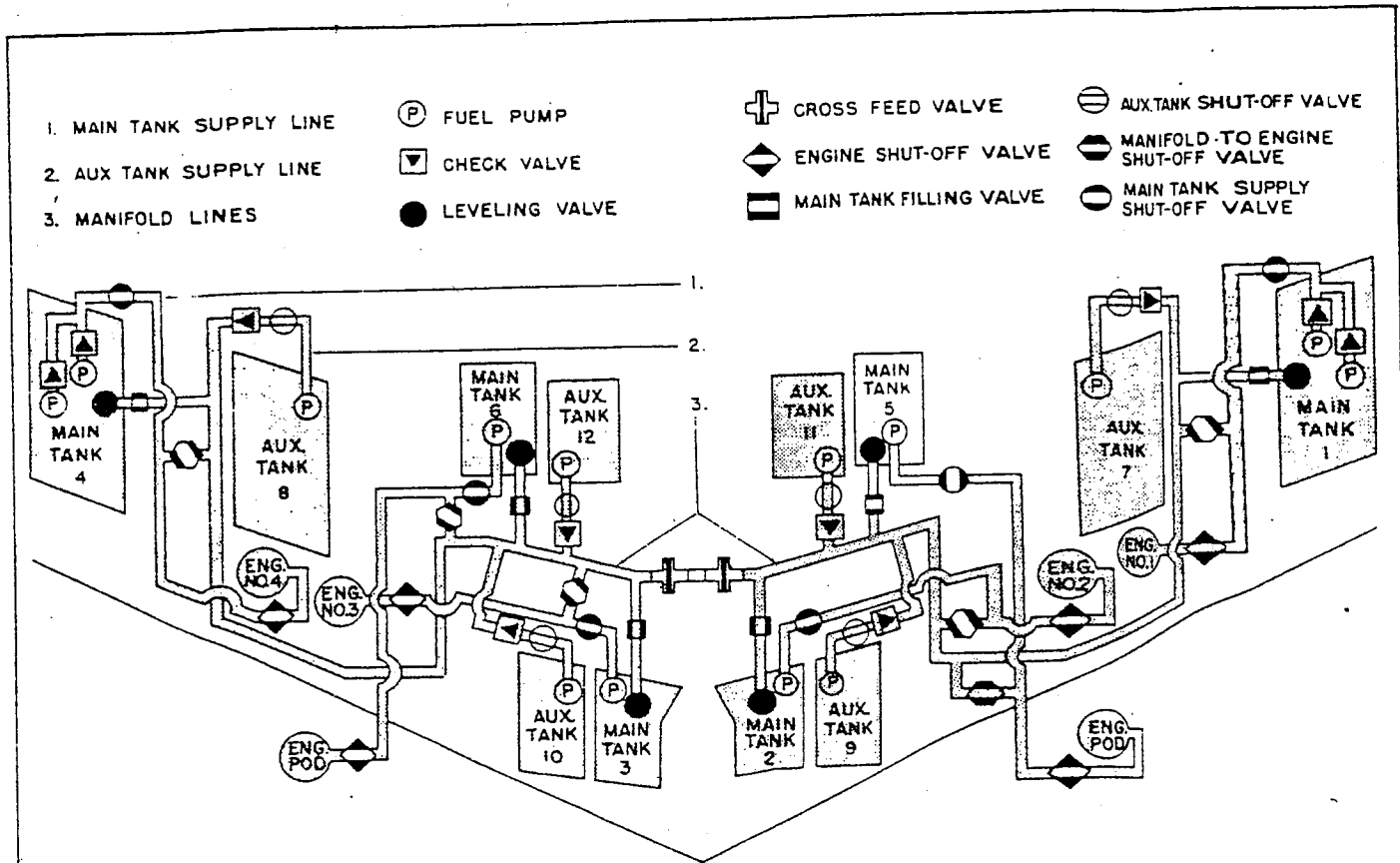

Figure 3-3 (Sheet 1 of 2 sheets). Fuel System Emergency Operation



MAIN TANK MECHANICAL FAILURE

1. AFFECTED MAIN TANK SELECTOR SWITCH-"MANIFOLD TO ENGINE"
2. AFFECTED MAIN TANK FILL-TANK SWITCH-"OFF"
3. OTHER MAIN TANK SELECTOR SWITCHES-"NORMAL TANK TO ENGINE"
4. OTHER MAIN TANK FILL-TANK SWITCHES-"ON"
5. AUXILIARY TO MANIFOLD SWITCHES-"ON"
6. CROSSFEED SWITCH-"OFF"

NOTE. WHEN AUXILIARY TANKS ARE EMPTY, AT LEAST ONE MAIN TANK SELECTOR MUST BE SWITCHED TO "TANK TO MANIFOLD AND ENGINE" IF MAIN TANK SELECTED IS ON OPPOSITE SIDE, CROSSFEED SWITCH MUST BE TURNED "ON"

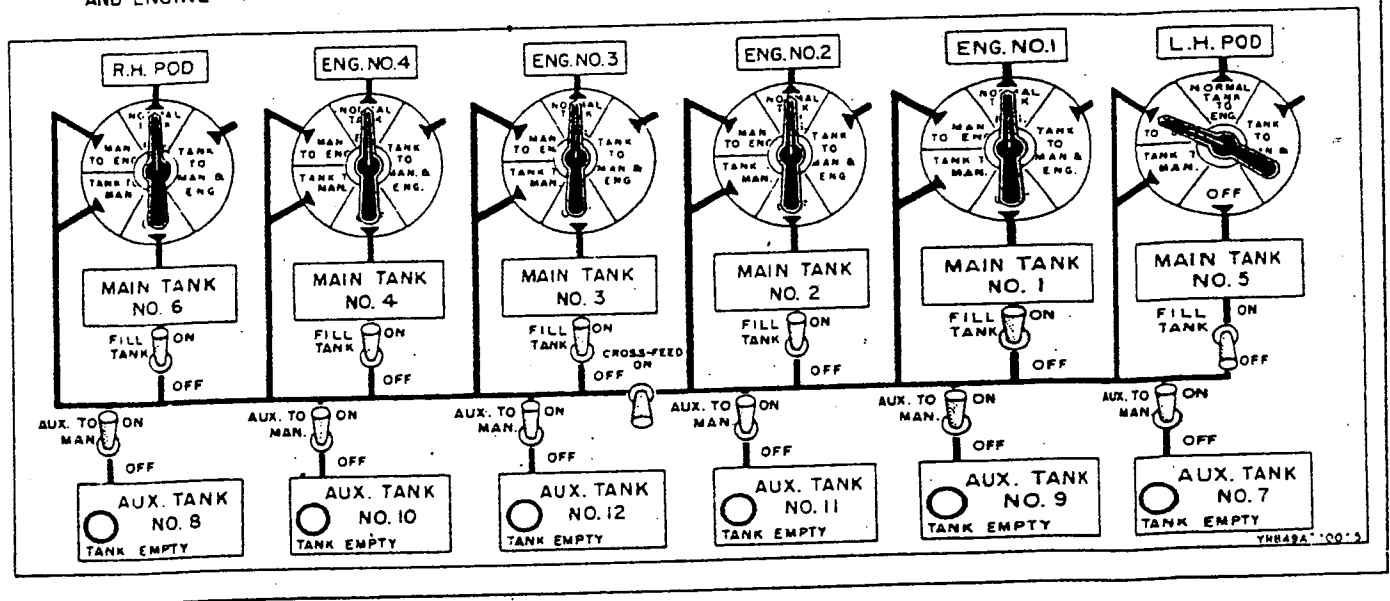

Figure 3-3 (Sheet 2 of 2 sheets). Fuel System Emergency Operation

Section III  
Paragraphs 3-36 to 3-51

crew member nearest center crew nacelle section pull out both life raft release handles (see figure 1-29 and 11, figure 3-2).

k. Climb onto top of crew nacelle through enclosure escape opening, astrodome opening, and upper escape hatch in the center crew nacelle section.

l. If life rafts have not been released and inflated by pulling the life raft release handles inside the airplane, open the life raft compartment doors by means of the handles in their outer surfaces, pull the short cables attached to the CO<sub>2</sub> bottles in the compartments.

m. Man the life rafts and cast off from the airplane. Cut the light cord which ties each life raft to the airplane.

3-37. FUEL SYSTEM EMERGENCY OPERATION.

3-38. ENGINE FAILURE. (See figure 3-3, Sheet 1.)

3-39. FUEL TANK FAILURE. (See figure 3-3, Sheet 2.)

3-40. FLIGHT CONTROLS EMERGENCY OPERATION.

3-41. GENERAL.

3-42. Failure of an internal engine, reduction of internal engine rpm's below 57%, or failure of a component in one of the power surface control hydraulic systems, may reduce the hydraulic pressure in the power surface control systems on that side of the airplane to the point that simultaneous operation of the control surfaces at their maximum rate of movement is not possible. In the event of such lowering of hydraulic pressure, normal control surface operation can be obtained by operating the emergency elevon and trim flap hydraulic systems. These systems are energized by pressing the emergency elevon button on either control stick. As long as one or more engine-driven generators are in operation, the emergency elevon and trim flap hydraulic systems can be operated as often and as long as necessary to obtain the desired control surface movements. Under such conditions, the emergency systems produce hydraulic pressure to augment the pressure in the power surface control systems.

3-43. Should all internal engines or all power surface control systems fail, operate the control surfaces as long as possible in the normal manner by means of the hydraulic power produced by the windmilling engines. When operating with such low hydraulic pressure, interaction of the control surfaces may be experienced. For example, if the control stick is pulled back to produce "elevator" action and, at the same time, the left rudder pedal is pressed, the left elevon will move more slowly than the right elevon, creating some "aileron" action. When faster control surface speeds are required, operate the emergency elevon and trim flap hydraulic systems by pressing the emergency elevon button on one of the control sticks. If one or more engine-driven generators are operating, the emergency elevon and trim flap systems can be operated indefinitely. If the engine-driven generators are not operating, the emergency elevon and trim

flap systems are operated by battery power and can discharge the battery within 5 minutes, in which case the emergency systems should be operated continuously only during the approach and landing.

3-44. The rudders are not supplied with emergency hydraulic power, but a very low rate of rudder action is available from hydraulic pressure produced by windmilling engines.

3-45. TRIM FLAP FAILURE.

3-46. If the trim flaps are inoperative, land with the landing flaps up. During landings, the trim flaps are normally used to trim the negative pitch moment caused by lowering the landing flaps. If the trim flaps are inoperative, and the landing gear is down, control of the airplane for a proper landing flare is endangered by use of the landing flaps.

3-47. LANDING GEAR EMERGENCY OPERATION.

3-48. LANDING GEAR EMERGENCY EXTENSION PROCEDURE.

3-49. If the landing gear can not be extended by operation of the normal control system, use the following procedure:

WARNING

Reduce airspeed to 122 knots or less before operating landing gear emergency release.

a. Leave landing gear normal control handles in "DOWN" position.

b. Pull up on the landing gear control circuit breaker (46, figure 1-20) on the pilot's pedestal. The purpose of pulling the circuit breaker is to remove all power from the gear mechanisms so that the doors will not attempt to close after the gear is extended.

c. Set ratchet selector lever on landing gear emergency release handle (see figure 1-27), on side of oxygen tank well, to "UNLOCK GEAR" position.

d. Operate landing gear emergency release handle up and down until mechanism hits stop. Indicator above handle will move from "GEAR LOCKED" position to "GEAR UNLOCKED" position. When gear and door locks have been released, gear should extend of its own weight and be locked in down position by means of bungee action.

3-50. LANDING GEAR EMERGENCY RETRACTION PROCEDURE.

3-51. No provision is made for emergency retraction of the landing gear from the full down, locked position. In the event that any of the gear fails to extend completely during the emergency extension procedure outlined in paragraph 3-49 and it is desired to retract the gear for a crash landing, the following procedure shall be used:

NOTE

Emergency retraction is possible

only if the landing gear electrical system is in proper working order and failure of the gear to extend is due to causes other than power failure.

a. Set ratchet selector lever on landing gear emergency release handle to "LOCK GEAR" position.

b. Operate landing gear emergency release handle up and down until mechanism hits stop and indicator above handle is in "GEAR LOCKED" position.

c. Reset (push in) landing gear control circuit breaker on pilot's pedestal.

d. Place landing gear normal control handles in "UP" position for not less than 10 seconds. This will allow doors to open completely if they did not do so during the attempted emergency extension.

e. Place pilot's landing gear control handle in neutral position. (The handle is in neutral position when held in line with the word "gear" of the placard alongside the handle.) The handle can be held in this position by means of the hinged lock plate beside the handle (see figure 1-20).

f. Cut ac power from airplane by moving both alternator breaker switches to "OPEN" positions.

g. Place landing gear normal control handles in "DOWN" position for not less than 10 seconds. This will allow lock actuators to reset.

h. Place pilot's landing gear control handle in neutral position (see step d., above).

i. Restore ac power to airplane by moving both alternator breaker switches to "CLOSE" positions, with normal paralleling procedure.

j. Place landing gear normal control handles in "UP" position. All gear should retract and doors should close and lock.

3-52. BRAKES AND STEERING HYDRAULIC SYSTEM EMERGENCY OPERATION.

3-53. GENERAL.

3-54. If the brakes and steering hydraulic system fails to operate automatically, as indicated on the nose gear steering hydraulic pressure gage (2, figure 1-12) on the engineer's panel, the pump of the system may be energized by means of the hydraulic brake pump manual override switch (1, figure 1-12), located adjacent to the pressure gage. The normal electrical circuit of the system is controlled by the nose steering and brake circuit breaker (45, figure 1-20) on the pilot's pedestal; the emergency circuit is controlled by the emergency brake and steering circuit breaker switch (31, figure 1-4) on the engineer's switch panel. Failure of this system to operate automatically may be caused by emergency lowering of the gear, failure of the controlling limit-switches on the gear units or failure in the normal control circuit. The brakes and steering system pump is operated by the airplane's battery. If the engine-driven generators are not operating, the brakes and steering system pump should be operated only when absolutely necessary, in order to conserve battery power.

3-55. SHOULDER HARNESS EMERGENCY OPERATION.

3-56. GENERAL.

3-57. The pilot, copilot, and photo-navigator are prevented from bending forward when the shoulder harness inertia reel lock controls are in the locked position; therefore all switches not readily accessible should be "cut" before moving the controls to the locked position in preparation for a forced landing.

RESTRICTED  
AN 01-15EBB-1

RESTRICTED

SECTION IV  
OPERATIONAL EQUIPMENT

4-1. PHOTOGRAPHIC EQUIPMENT.

4-2. GENERAL.

4-3. Five camera installations - forward oblique, multiple, trimetrogon, stabilized vertical, and alternate split vertical - are located within the crew nacelle. (See figure 4-1.) Each camera installation is equipped with a plate glass window. Except at the forward, flexible camera station, electrically-operated camera well doors cover the camera windows when the cameras are not in use. Each camera window is provided with a blower-type defrosting system. A dry-air vacuum system provides vacuum for each camera. All controls for operation of the cameras, camera doors, and vacuum system are installed on the photo-navigator's camera control panel (see figure 4-2), located in the forward crew nacelle section to the right of the pilot's station. A Type B-2 aerial photo viewfinder, model A-2VF, is installed at the photo-navigator's station.

4-4. PHOTOGRAPHIC EQUIPMENT CONTROLS.

4-5. CAMERA MASTER SWITCH AND INDICATOR LIGHT. The camera master switch (12, figure 4-2) is a two-position, on-off switch. When it is in the "OFF" position, all photographic equipment circuits are dead; when it is placed in the "ON" position, power is supplied to the viewfinder, camera control bus, camera control, camera doors, and camera vacuum switches. The camera master indicator light illuminates when the master switch is in the "ON" position.

4-6. AC POWER SWITCH AND INDICATOR LIGHT. Placing the ac power switch (11, figure 4-2) in the "ON" position supplies power to the ac power bus, camera door-actuator motors, A-14 magazine amplifier, and the A-28 mount amplifier. The ac power indicator light illuminates when the ac power switch is in the "ON" position.

4-7. CAMERA CONTROL SWITCHES. A three-position camera control switch (3, figure 4-2) is provided for each camera installation. These switches are used to select either automatic or manual operation of the individual cameras.

4-8. CAMERA CONTROL CIRCUIT BREAKERS. The push-to-reset type camera control circuit breakers are located on the camera control panel (14 through 24, figure 4-2) and on the camera power distribution panel (see figure 4-4), located on the right-hand side of the center crew nacelle section.

4-9. SPLIT VERTICAL - MULTIPLE CAMERA SELECTOR SWITCH. The alternate split vertical camera installation utilizes the forward multiple camera mount, with camera installation at 18°. The split vertical-multiple camera selector switch (2, figure 4-2) is used to select the

camera installation to be used.

4-10. CAMERA DOOR SWITCHES AND INDICATOR LIGHTS. The camera door switches (4, figure 4-2) have three positions - "OPEN," "OFF," and "CLOSE." Placing one of these switches in the "OPEN" position opens the corresponding camera doors. When all of the doors of the selected camera installation reach the full open positions, the indicator light above the switch glows. Placing a camera door switch in the "CLOSE" position returns the selected doors to the closed position and turns out the indicator light.

4-11. CAMERA FANS CIRCUIT BREAKER AND INDICATOR LIGHT. The camera fans circuit is controlled by the engineer's cabin air selector switch (21, figure 1-4). When that switch is placed in the "CABIN PRESSURE" position, the camera fans operate and the camera fans indicator light on the camera control panel lights. The camera fans circuit is protected by a camera fans circuit breaker (10, figure 4-2) on the camera control panel. The photo-navigator can cut the fans off by pulling out on the circuit breaker.

4-12. CAMERA VACUUM SYSTEM SWITCHES AND INDICATOR LIGHT. Placing the two-position vacuum system switch (8 figure 4-2) in the "ON" position starts the vacuum pumps operating. Returning the switch to the "OFF" position stops the pumps. The vacuum system indicator light goes on when the vacuum pumps are running. Individual vacuum control switches are also provided on the camera control panel for the trimetrogon and the forward oblique cameras.

4-13. CAMERA VACUUM SYSTEM CIRCUIT BREAKERS. The vacuum system circuit breakers (13 and 14, figure 4-4) are of the push-to-reset type and are located on the vacuum relay panel and on the camera power distribution panel in the center crew nacelle section.

4-14. PILOT'S WARNING SELECTOR SWITCH. The pilot's warning selector switch (9, figure 4-2), located on the camera control panel, is placed in the position corresponding to the camera installation to be operated. The intervalometer for that camera installation will then illuminate the camera intervalometer warning light (14, figure 1-19) on the pilot's instrument panel before camera operation.

4-15. INTERVALOMETER INITIATION SWITCH AND INDICATOR LIGHT. The two-position, on-off intervalometer initiation switch (1, figure 4-2) is used to supply power for operation of the intervalometers. The indicator light above the switch goes on when the switch is placed in the "ON" position.

4-16. A-14 MAGAZINE AND A-28 MOUNT CONTROL PROVISIONS. Provisions are made on the lower

end of the camera control panel for mounting one A-14 magazine control and one A-28 mount control to be used with the stabilized vertical camera installation.

4-17. INTERVALOMETERS. The intervalometers (7, figure 4-2) on the camera control panel are used to regulate automatically the time interval at which exposures of the cameras are made.

4-18. PHOTOGRAPHIC EQUIPMENT INDICATORS.

4-19. MULTIPLE CAMERA INDICATOR LIGHTS. Multiple camera indicator lights (5, figure 4-2), one for each camera of the multiple camera installation, are mounted at the top of the camera control panel. Each indicator light illuminates each time an exposure is

made, either automatically or manually, with the corresponding camera.

4-20. EXPOSURE COUNTERS. The exposure counters (6, figure 4-2) on the camera control panel are of the subtractive type and indicate the number of exposures left in the film magazines.

4-21. PILOT'S CAMERA INTERVALOMETER WARNING LIGHT. The pilot's camera intervalometer warning light (14, figure 1-19) is located on the right-hand side of the pilot's instrument panel. The indicator light is controlled by the camera intervalometers and gives the pilot a visual warning to level or steady the airplane before operation of the cameras.

4-22. PILOT'S PHOTO OPERATIONS INDICATOR LIGHT.

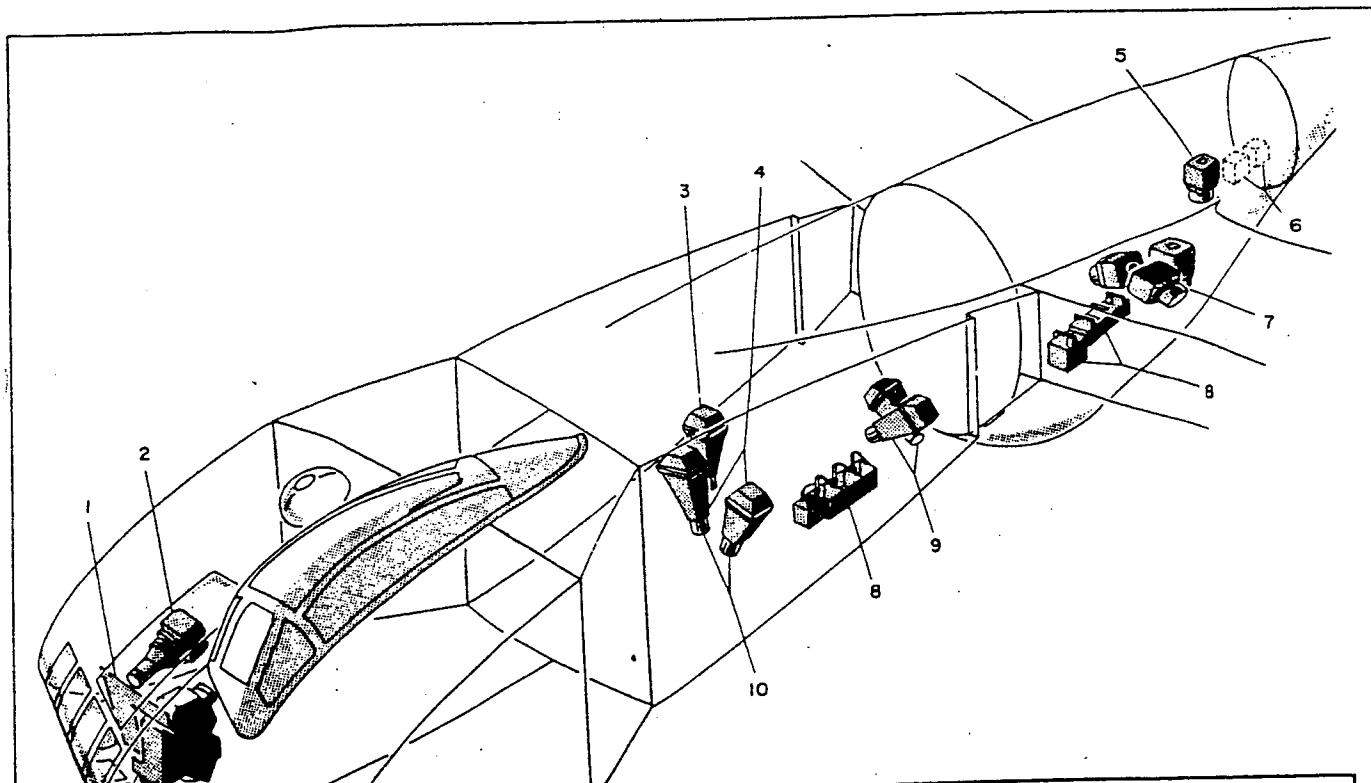

REF	NAME	LOCATION
1.	CAMERA CONTROL PANEL	FORWARD CREW NACELLE
2.	FORWARD OBLIQUE CAMERA STATION	FORWARD CREW NACELLE
3.	MULTIPLE CAMERA STATION (VERTICAL)	CENTER CREW NACELLE
4.	MULTIPLE CAMERA STATION (FORWARD 25°)	CENTER CREW NACELLE
5.	STABILIZED VERTICAL CAMERA STATION	AFT CREW NACELLE
6.	PROVISIONS FOR MOUNTING A-14 FILM MAGAZINE AND AMPLIFIER	AFT CREW NACELLE
7.	TRIMETROGON CAMERA STATION	AFT CREW NACELLE
8.	STOWAGE RACKS	CENTER AND AFT CREW NACELLE
9.	MULTIPLE CAMERA STATION (AFT 70°)	CENTER CREW NACELLE
10.	18° 30' SPLIT VERTICAL CAMERA STATION (ALTERNATE)	CENTER CREW NACELLE
11.	VIEWFINDER	PHOTO-NAVIGATOR'S STATION

Figure 4-1. Photographic Equipment



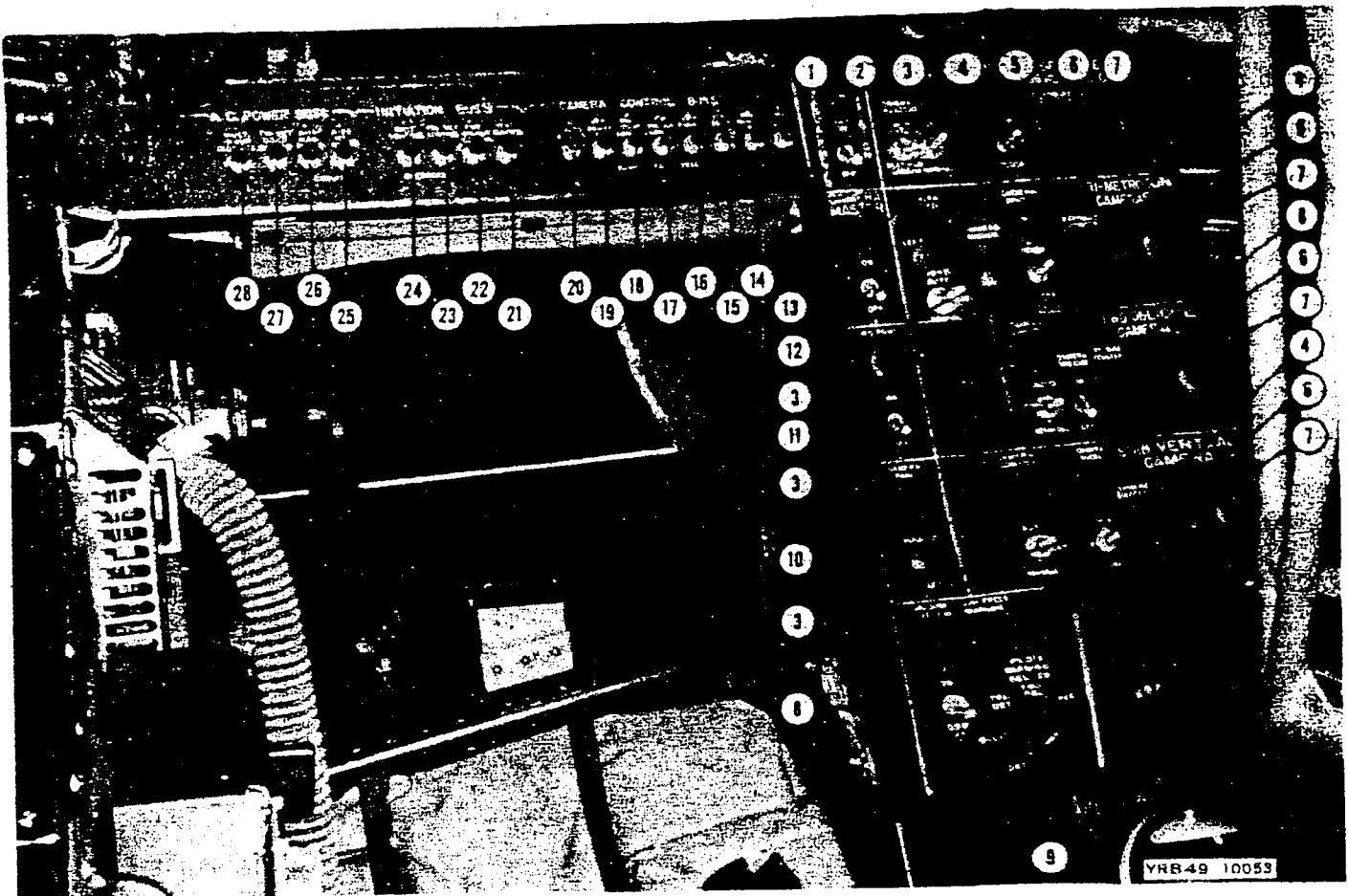

- |   |   |
|---|---|
| 1. INTERVALOMETER INITIATION SWITCH               | 16. VIEWFINDER CIRCUIT BREAKER                    |
| 2. SPLIT VERTICAL-MULTIPLE CAMERA SELECTOR SWITCH | 17. FORWARD OBLIQUE CAMERA CIRCUIT BREAKER        |
| 3. CAMERA CONTROL SWITCH                          | 18. MULTIPLE DOOR CONTROL CIRCUIT BREAKER         |
| 4. CAMERA DOORS SWITCH                            | 19. VERTICAL MANUAL TRIP CIRCUIT BREAKER          |
| 5. MULTIPLE CAMERA INDICATOR LIGHTS               | 20. INDICATOR LIGHTS AND COUNTERS CIRCUIT BREAKER |
| 6. EXPOSURE COUNTER                               | 21. VERTICAL CONTROL CIRCUIT BREAKER              |
| 7. INTERVALOMETER                                 | 22. FORWARD OBLIQUE CONTROL CIRCUIT BREAKER       |
| 8. VACUUM SYSTEM SWITCH                           | 23. TRI-METROGON CONTROL CIRCUIT BREAKER          |
| 9. PILOT'S WARNING SELECTOR SWITCH                | 24. MULTIPLE CONTROL CIRCUIT BREAKER              |
| 10. CAMERA FANS CIRCUIT BREAKER                   | 25. A-28 MOUNT POWER CIRCUIT BREAKER              |
| 11. AC POWER SWITCH                               | 26. A-14 MAGAZINE POWER CIRCUIT BREAKER           |
| 12. CAMERA MASTER SWITCH                          | 27. TRI-METROGON DOOR MOTORS CIRCUIT BREAKER      |
| 13. INDICATOR LIGHT TEST CIRCUIT BREAKER          | 28. MULTIPLE DOOR MOTORS CIRCUIT BREAKER          |
| 14. MULTIPLE MANUAL TRIP CIRCUIT BREAKER          |   |
| 15. VERTICAL DOOR CIRCUIT BREAKER                 |   |

Figure 4-2. Camera Control Panel

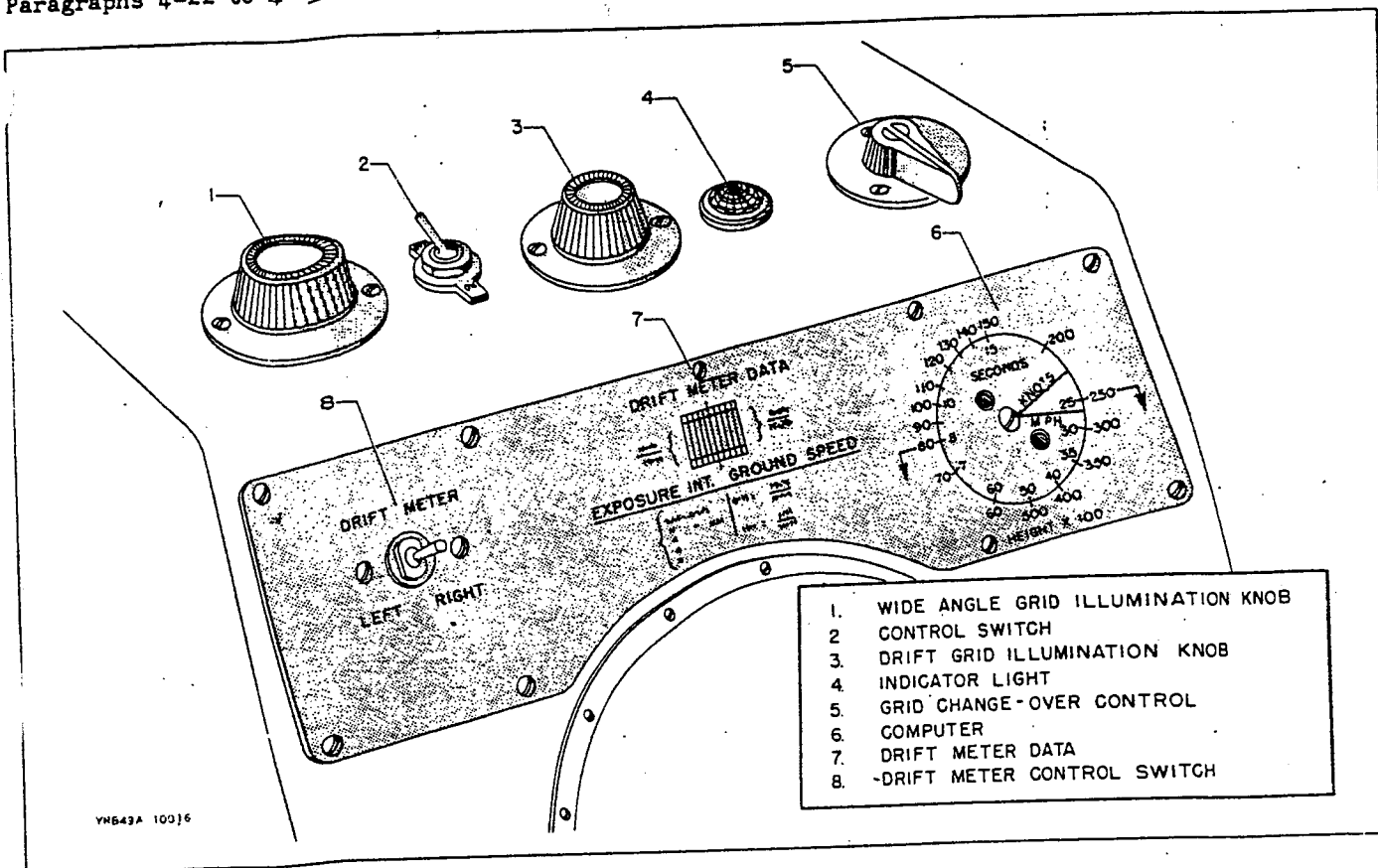

Figure 4-3. Viewfinder Controls

A photo operations indicator light (15, figure 1-19) on the right-hand side of the pilot's instrument panel is provided to give the pilot visual indication of camera operation.

4-23. VIEWFINDER.

4-24. The Type B-2, model A-2VF, aerial photo viewfinder provides the photo-navigator with a view of the terrain below and ahead of the airplane for flight line navigation and the location of photographic targets. The viewing system consists of two integrated optical systems. The wide-angle objective system has an included field of eighty-five degrees, with the optical axis tilted forward and upward, in the longitudinal plane,  $37^\circ$  from the vertical. The system furnishes the observer with an extended view from near the forward horizon to a point  $5^\circ$  behind the vertical. The drift system optical axis is vertical and its view covers a field of  $30^\circ$  directly below the airplane for the purpose of determining drift; this system serves also as a photographic viewfinder for cameras having a relatively small field angle. Suitable grids, having controlled illumination, are provided in both systems for the solution of drift problems, location of track line, and the determination of the field of the various cameras. Two dyed-glass viewing filters are provided in each system, and either or both may be inserted in the optical paths, at the discretion of the observer.

4-25. VIEWFINDER CONTROLS.

4-26. The controls for operation of the viewfinder are located on top of the unit (see figure 4-3) and on the right-hand side of the unit.

4-27. CONTROL SWITCH AND INDICATOR LIGHT. An on-off control switch (2, figure 4-3), which controls operation of the viewfinder, is located on top of the unit. When the switch is on, the indicator light illuminates.

4-28. GRID ILLUMINATION KNOBS. A wide angle grid illumination knob (1, figure 4-3) and a drift grid illumination knob (3, figure 4-3) control the intensity of illumination of the grids of the two viewing systems.

4-29. GRID CHANGE-OVER CONTROL. The grid change-over control (5, figure 4-3) is operated to actuate the mirror change-over system, for switching from the wide angle system to the drift system.

4-30. DRIFTMETER CONTROL SWITCH. The drift-meter control switch (8, figure 4-3) is moved to the "LEFT" or "RIGHT" positions to move the drift grid to the left or right.

4-31. COMPUTER. A circular slide-rule computer (6, figure 4-3) on the viewfinder is used for computing the ground speed of the airplane.

4-32. FILTER CONTROL KNOBS. The control knobs for the filters are on the right-hand side of the viewfinder case.

4-33. OPERATION OF VIEWFINDER.

- a. Place the control switch in "ON" position.
- b. Shift the viewfinder to the vertical drift system by moving the grid change-over control to the "DRIFT" position.
- c. Choose a point of detail in the image which falls on or near one of the tracking lines parallel to the center track line, and follow the point back across the field of the instrument.
- d. Make the necessary changes in the drift angle of the grid to bring the track of the image point parallel to the grid lines by operating the driftmeter control switch.
- e. When correctly adjusted, all points in the image will track parallel to the grid track lines, and the drift has been fully corrected.

NOTE

After correcting for drift, any change in the heading of the airplane to bring the wide-angle track line into alignment with the flight line may introduce some drift error and require another drift correction.

f. Shift the viewfinder back to the wide-angle system, which will show the entire area ahead of the airplane.

g. Note that the track line in the wide-angle grid has moved, relative to the airplane heading, in the same direction as the drift correction.

h. If the drift has been fully corrected, the wide-angle track line will now define the true track of the airplane on the ground, and any necessary adjustment in the airplane heading must be made to bring the track line into coincidence with the desired flight line on the ground.

i. After bringing the airplane into the correct position over the flight line, it must be held there by frequent drift and heading corrections.

j. Under certain extreme conditions of lighting, it will be necessary to introduce certain of the dyed-glass viewing filters, at the discretion of the observer.

4-34. DETERMINATION OF GROUND SPEED.

- a. Time the travel of an image point across the square drift grid.

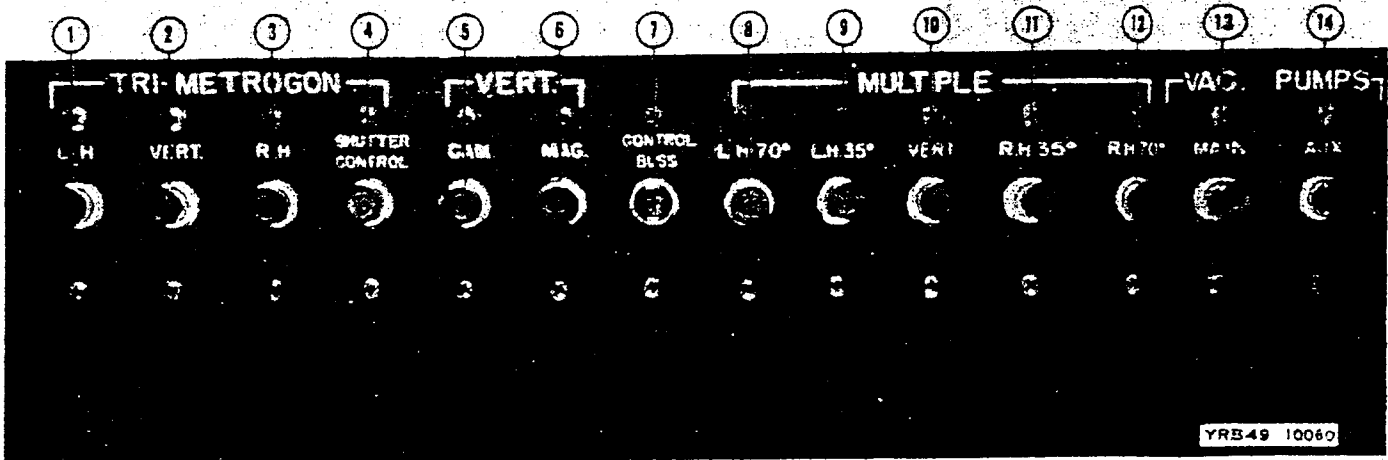

- |   |  |
|---|--|
| 1. L.H. TRI-MET CAMERA CIRCUIT BREAKER            | 8. L.H. 70° MULTIPLE CAMERA CIRCUIT BREAKER  |
| 2. VERT. TRI-MET. CAMERA CIRCUIT BREAKER          | 9. L.H. 35° MULTIPLE CAMERA CIRCUIT BREAKER  |
| 3. R.H. TRI-MET CAMERA CIRCUIT BREAKER            | 10. VERTICAL MULTIPLE CAMERA CIRCUIT BREAKER |
| 4. TRI-MET CAMERA SHUTTER CONTROL CIRCUIT BREAKER | 11. R.H. 35° MULTIPLE CAMERA CIRCUIT BREAKER |
| 5. VERTICAL CAMERA CIRCUIT BREAKER                | 12. R.H. 70° MULTIPLE CAMERA CIRCUIT BREAKER |
| 6. VERTICAL CAMERA MAGAZINE CIRCUIT BREAKER       | 13. MAIN VACUUM PUMP CIRCUIT BREAKER         |
| 7. CONTROL BUS CIRCUIT BREAKER                    | 14. AUXILIARY VACUUM PUMP CIRCUIT BREAKER    |

Figure 4-4. Camera Power Distribution Panel (In Center Crew Nacelle Section)

Section IV  
Paragraphs 4-34 to 4-38

b. On the computer, set the time in seconds "t," on the inner scale, opposite the altitude, on the outer scale, and read the true ground speed opposite the appropriate index for "KNOTS."

NOTE

It is essential that the airplane be maintained stable in a normal flight attitude during this procedure.

4-35. OPERATION OF PHOTOGRAPHIC EQUIPMENT.

4-36. PHOTO-NAVIGATOR'S PREFLIGHT CHECK - BEFORE ENGINES ARE STARTED.

a. Check Form 1.

b. Exposure counters - Set to number of exposures in camera film magazines.

c. Circuit breakers on camera control panel, and vacuum pump relay panel - Reset.

d. Cabin presaturated at a desired air temperature and cabin air temperature controls set to maintain the same temperature.

4-37. PHOTO-NAVIGATOR'S PREFLIGHT CHECK - AFTER ENGINES ARE STARTED.

a. Ac power switch - "ON."

b. Camera master switch - "ON."

c. Indicator lights - Test.

d. Camera vacuum system switch - "ON."

e. Camera doors - Check operation.

f. Camera operation - Check.

g. All switches - "OFF."

4-38. PHOTO-NAVIGATOR'S CAMERA OPERATION CHECK - BEFORE PHOTOGRAPHY.

a. Ac power switch - "ON."

b. Camera master switch - "ON."

c. Camera vacuum system switch - "ON."

d. Camera selector switch - "SPLIT VERTICAL" or "MULTIPLE CAMERA" position, as desired.

e. Camera doors switches - "OPEN."

f. A-28 mount and A-14 film magazine switches - "ON."

g. Camera control switches - "AUTO" or "MANUAL," as desired.

h. Intervalometers - Set intervals.

i. Pilot's warning selector switch - Set to camera to be used.

j. Intervalometer initiation switch - "ON."

k. For night photography, co-ordinate with radar-navigator for release of photoflash bombs.

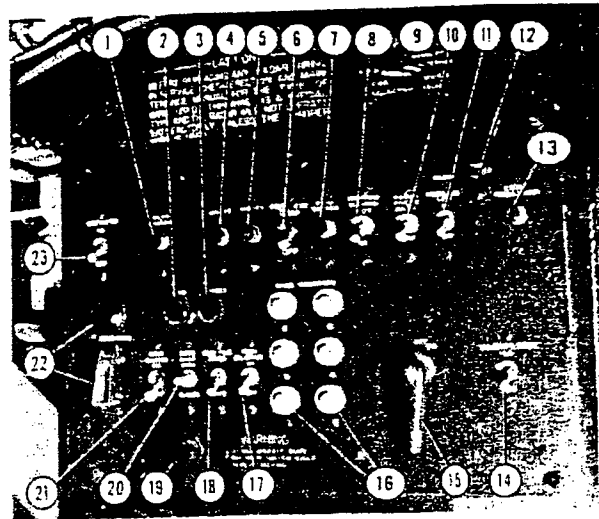

1. RADAR CAMERA CIRCUIT BREAKER SWITCH
2. BOMB BAY DOOR OPEN INDICATOR LIGHT (RED)
3. BOMB NOSE-FUSES ARMED INDICATOR LIGHT
4. APA-44 RADAR CIRCUIT BREAKER
5. APS-23 RADAR CIRCUIT BREAKER SWITCH
6. FREE AIR TEMPERATURE INDICATOR SWITCH
7. GYRO COMPASS CIRCUIT BREAKER SWITCH
8. COMPASS SLAVING CONTROL SWITCH
9. STATIC PRESSURE SELECTOR VALVE
10. RADAR PRESSURE CONTROL SWITCH
11. RADAR PRESSURE PUMP TEST SWITCH
12. RADAR PRESSURE PUMP INDICATOR LIGHT
13. RADAR PRESSURE PUMP CIRCUIT BREAKER SWITCH
14. BOMB STATION INDICATOR LIGHTS TEST SWITCH
15. BOMB STATION INDICATOR LIGHTS CONTROL SWITCH
16. BOMB STATION INDICATOR LIGHTS (6)
17. BOMB SELECTOR SWITCH
18. BOMB NOSE-FUSE ARMING SWITCH
19. BOMB BAY DOOR CLOSED INDICATOR LIGHT (GREEN)
20. BOMB BAY DOOR CONTROL SWITCH
21. BOMB MASTER SWITCH
22. BOMB SALVO SWITCH AND INDICATOR LIGHT
23. DRIFTMETER SWITCH

Figure 4-5. Radar-Navigator's Switch Panel

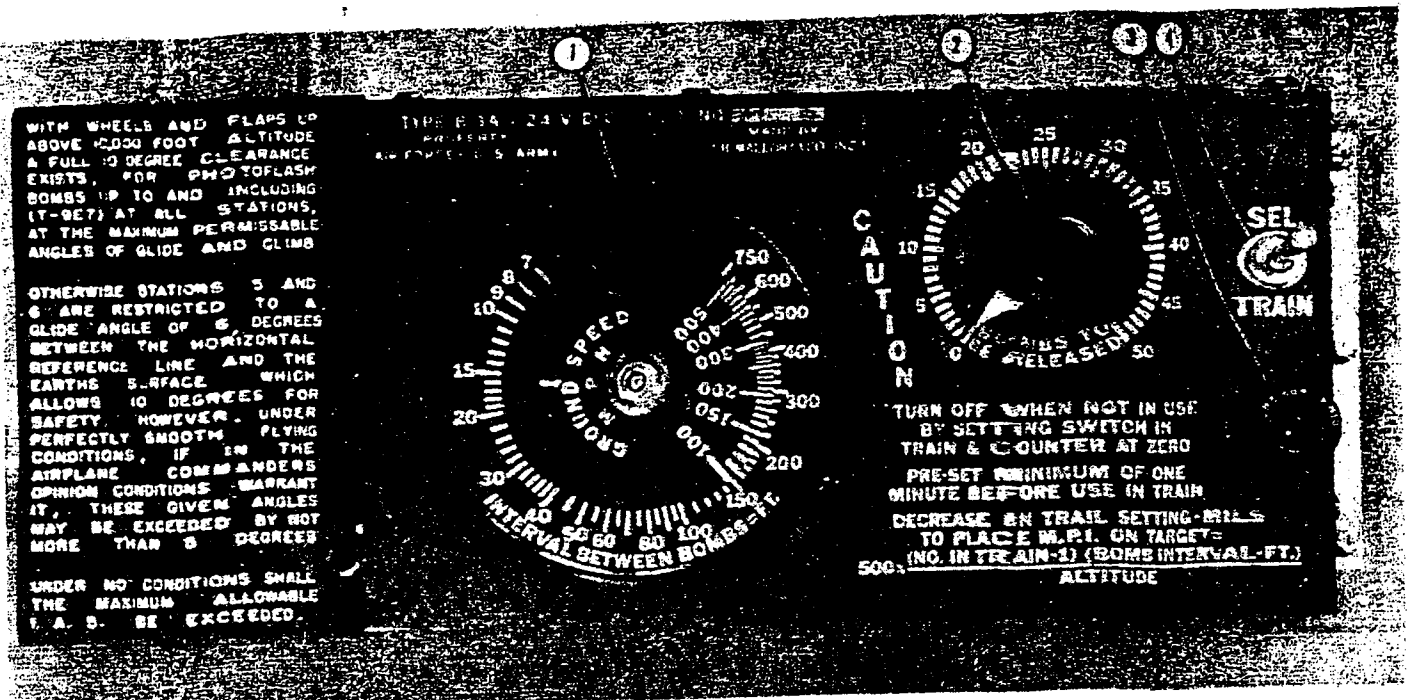

1. INTERVAL SELECTOR
2. BOMB COUNTER SWITCH
3. BOMB RELEASE INDICATOR LIGHT
4. TRAIN-SELECTIVE SELECTOR SWITCH

Figure 4-6. Photoflash Bombing Intervalometer Panel

- 4-39. PHOTO-NAVIGATOR'S CAMERA OPERATION CHECK - AFTER PHOTOGRAPHY.
- a. Intervalometer initiation switch - "OFF."
  - b. Pilot's warning selector switch - "OFF."
  - c. Camera control switches - "OFF."
  - d. A-28 mount and A-14 film magazine switches "OFF."
  - e. Camera doors switches - "CLOSE."
  - f. Camera vacuum system switches - "OFF."
  - g. Camera master switch - "OFF."
  - h. Ac power switch - "OFF."
  - i. Notify engineer to regulate cabin air temperature as desired.
  - j. Camera fans circuit breaker - Pull out to shut off camera fans.
- 4-40. PHOTOFLASH BOMBING EQUIPMENT.
- 4-41. GENERAL.
- 4-42. The bomb bay is equipped with racks for carrying and releasing six photoflash bombs. The electrically-operated, flexible bomb bay door rolls onto a drum at the aft end of the bomb bay when it is opened. Bombing controls and indicators are located on two panels (see figures 4-5 and 4-6) at the radar-navigator's station. In addition, emergency bomb salvo controls are provided at the pilot's station and in the center crew nacelle section.
- 4-43. PHOTOFLASH BOMBING CONTROLS.
- 4-44. BOMB MASTER SWITCH. The bomb master switch (21, figure 4-5) opens and closes the

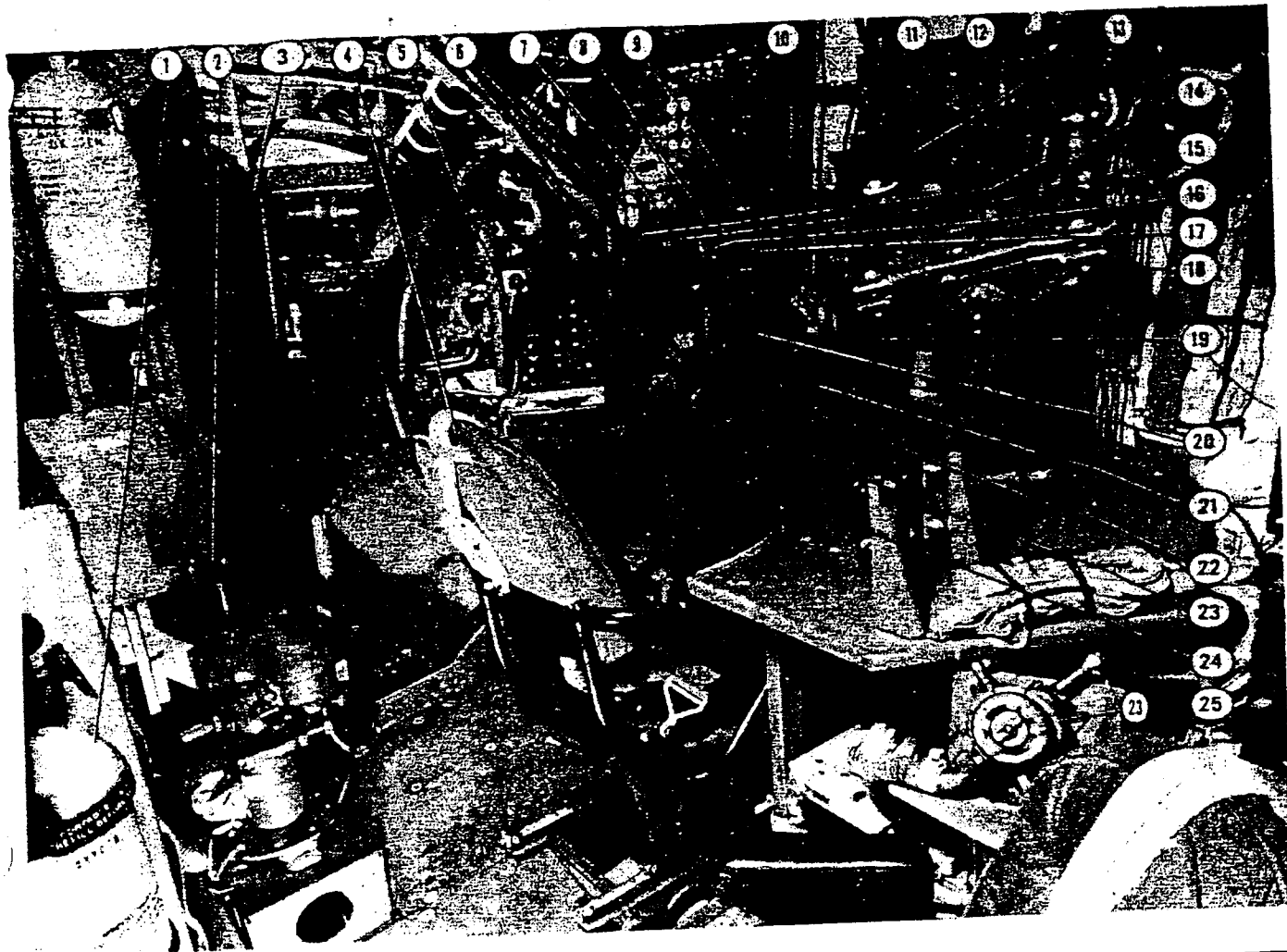

- |   |   |
|---|---|
| 1. PORTABLE OXYGEN BOTTLES                  | 15. MONITOR VOLTMETER                               |
| 2. DRIFTMETER                               | 16. RADAR PRESSURE GAGE                             |
| 3. PHOTO-NAVIGATOR'S SEAT                   | 17. CLOCK   |
| 4. RADAR-NAVIGATOR'S SEAT                   | 18. ID-218/APS-23 RADAR INDICATOR MOUNTING BASE     |
| 5. AN/APN LORAN                             | 19. CP-21 BALLISTICS COMPUTER MOUNTING BASE         |
| 6. ALTIMETER                                | 20. HEATED CLOTHING CONTROL BOX                     |
| 7. TRUE AIRSPEED INDICATOR                  | 21. AUTO-PILOT REMOTE TURN CONTROL MOUNTING BRACKET |
| 8. SLAVED GYRO MAGNETIC COMPASS             | 22. INTERPHONE CONTROL PANEL                        |
| 9. STEER METER                              | 23. OXYGEN REGULATOR                                |
| 10. SWITCH PANEL                            | 24. TRACKING CONTROL UNIT MOUNTING BRACKET          |
| 11. BOMB RELEASE SWITCH                     | 25. ENGINEER'S SEAT                                 |
| 12. PHOTOFLASH BOMBING INTERVALOMETER PANEL |   |
| 13. CP-22 MILEAGE COMPUTER MOUNTING BASE    |   |
| 14. FREE AIR TEMPERATURE INDICATOR          |   |

7848A 10055

Figure 4-7. Radar-Navigator's Station

electrical power supply circuit for the bombing control system and the bomb bay door control system.

4-45. TRAIN-SELECTIVE SELECTOR SWITCH. The train-selective selector switch (4, figure 4-6) is used to select either train or selective bomb release. When the switch is in the "TRAIN" position and it is desired to stop the train release before all bombs have been released, moving the switch to the "SEL" position stops the release of bombs.

4-46. BOMB COUNTER SWITCH. The rotary-type bomb counter switch (2, figure 4-6), on the intervalometer panel, is used to select the number of bombs to be dropped in train release. During train release of bombs, if it is desired to drop more than the number of bombs originally selected, the bomb counter switch can be held at the number desired. Turning the bomb counter switch to the "O" position, at any time, automatically stops the release of bombs. The switch must be set at least one minute before the release of bombs.

4-47. INTERVAL SELECTOR. The interval selector (1, figure 4-6) is set to regulate the spacing in feet, relative to ground speed, of the bombs to be dropped in train.

4-48. BOMB BAY DOOR CONTROL SWITCH AND INDICATOR LIGHTS. The bomb bay door control switch (20, figure 4-5) is a two-position switch on the radar-navigator's switch panel. When the bomb master switch is on, moving the bomb bay door control switch to the "OPEN" or "CLOSED" position opens or closes the door. A red indicator light (2, figure 4-5) above the switch illuminates when the bomb bay door is open; a green indicator light (19, figure 4-5) below the switch illuminates when the door is closed.

4-49. NOSE-FUSE ARMING SWITCH AND INDICATOR LIGHT. The nose-fuse arming switch (18, figure 4-5), on the radar-navigator's switch panel, is placed in the "ARMED" position to arm all bombs simultaneously. When the switch is in the "ARMED" position, the red indicator light (3, figure 4-5) above the switch is illuminated.

4-50. BOMB SELECTOR SWITCH. The bomb selector switch (17, figure 4-5) controls the supply of power to the bomb release system. When this switch is in the "ON" position, the selector relay automatically transfers release impulses from one rack to another.

4-51. BOMB RELEASE SWITCH. A standard, press-to-release, bomb release switch (11, figure 4-7) is on the end of a flexible cord which extends from the aft side of the radar-navigator's switch panel and is stowed in a clip on the cabin wall above the photoflash bombing intervalometer panel.

4-52. BOMB SALVO SWITCHES AND INDICATOR LIGHTS. Bomb salvo switches (22, figure 4-5; 9, figure 1-21) and indicator lights are located on the radar-navigator's switch panel, to the left of the pilot's station, and on the left-hand side of the center crew nacelle section near the escape hatch into the bomb bay. Moving any one of these switches to the "ON" position illuminates all of the bomb salvo indicator

lights, opens the bomb bay door, and drops all the bombs. Any one of these switches is operated to open and empty the bomb bay in preparation for emergency escape through the bomb bay escape hatch.

4-53. PHOTOFLASH BOMBING INDICATORS.

4-54. BOMB STATION INDICATOR LIGHTS AND LIGHT CONTROL SWITCHES. An indicator light (16, figure 4-5) for each bomb station is provided on the radar-navigator's switch panel. When the spring-loaded light control switch (15, figure 4-5) next to the lights is held momentarily in the "ON" position, lights corresponding to the loaded bomb stations glow. An indicator lights test switch (14, figure 4-5) is provided on the panel for testing the operation of the indicator light bulbs.

4-55. BOMB RELEASE INDICATOR LIGHT. A bomb release indicator light (3, figure 4-6) is located on the bombing intervalometer panel. It illuminates when the train-selector switch has been set and indicates that pressure on the bomb release switch will release one or more bombs.

4-56. OPERATION OF PHOTOFLASH BOMBING EQUIPMENT.

4-57. RADAR-NAVIGATOR'S PHOTOFLASH BOMBING PROCEDURE.

4-58. RELEASING BOMBS.

- a. Bomb master switch - "ON."
- b. Bomb station indicator lights - Test bulbs by holding indicator lights test switch in the "ON" position.
- c. Train-selective selector switch - Set to "TRAIN" or "SEL," as desired.
- d. Bomb counter switch - Set to number of bombs to be dropped, if train release.
- e. Interval selector - Set to interval desired, if train release.
- f. Bomb bay door switch - "OPEN."

#### CAUTION

Do not attempt to change direction of door movement while door is moving.

- g. Nose-fuse arming switch - "ARMED."
- h. Bomb station indicator lights - Check loaded bomb stations by momentarily holding light control switch to "ON."

#### NOTE

Be sure switch is returned to "OFF" position; bombs can not be released armed while switch is on.

- i. Bomb selector switch - "ON."
- j. Check with photo-navigator for bomb release time.

**Note**

As an airplane ascends high altitudes, where the temperature is normally quite low, the oxygen cylinders become chilled. As the cylinders grow colder, the oxygen gage pressure is reduced, sometimes rather rapidly. With a 100°F decrease in temperature in the cylinders the gage pressure can be expected to drop 20 per cent. This rapid fall in pressure is occasionally a cause for unnecessary alarm. All the oxygen is still there, and as the airplane descends to warmer altitudes, the pressure will tend to rise again, so that the rate of oxygen usage may appear to be slower than normal. A rapid fall in oxygen pressure while the airplane is in level flight, or while it is descending, is not ordinarily due to falling temperature, of course. When this happens, leakage or loss of oxygen must be suspected.

4-59. AFTER BOMBS ARE RELEASED.

- a. Bomb bay door switch - "CLOSED."
- b. Bomb selector switch - "OFF."
- c. Nose-fuse arming switch - "SAFE."
- d. Bomb master switch - "OFF."

4-60. EMERGENCY BOMB SALVO OPERATION.

- a. Nose-fuse arming switch - "SAFE."
- b. Bomb salvo switch (any of four in airplane) - "ON."

4-61. NAVIGATIONAL EQUIPMENT.

4-62. GENERAL.

4-63. The navigational equipment at the radar-navigator's station includes: an altimeter, true airspeed indicator, slaved gyro magnetic compass, gyro compass control switch and circuit breaker, steer meter, free air temperature indicator and control switch, monitor voltmeter, altimeter and airspeed hand set, driftmeter, and driftmeter control switch. A static pressure selector switch is located at the top of the radar-navigator's switch panel. A wooden case for the sextant and astro-compass is installed adjacent to the crew nacelle wall below the radar-navigator's table. Flares are stowed in a bag on the floor beneath the radar-navigator's table. A transparent astrodome is installed in the top of the airplane over the station.

4-64. DRIFT FLARE CHUTE.

4-65. A chute for the release of drift flares is mounted at the radar-navigator's station. The chute is designed to release flares without altering the air pressure within the crew nacelle.

4-66. OPERATION OF DRIFT FLARE CHUTE.

- a. Open top cover of chute.
- b. Attach loose end of flare arming-wire to shaft of top cover handle.
- c. Insert flare into chute and close top cover.
- d. Depress foot pedal at right side of chute to release flare.

**NOTE**

When the release (bottom) door of the chute closes after a flare is released, a vacuum is created within

	BELOW							
	400	350	300	250	200	150	100	100
40,000	7.9	6.8	5.7	4.7	3.8	2.9	2.3	1.1
35,000	7.9	6.8	5.7	4.7	3.8	2.9	2.3	1.1
30,000	5.7	4.9	4.1	3.3	2.5	1.7	1.1	0.8
25,000	4.4	3.6	3.0	2.5	1.9	1.3	0.9	0.8
20,000	3.4	2.9	2.4	1.9	1.4	1.0	0.8	0.8
15,000	2.7	2.3	1.9	1.5	1.2	0.8	0.8	0.8
10,000	2.2	1.9	1.5	1.2	0.9	0.6	0.6	0.6
	10.1	8.7	7.2	5.8	4.3	2.9	1.4	

BLACK FIGURES INDICATE DILUTER LEVER "NORMAL"  
 RED FIGURES INDICATE DILUTER LEVER "100%"  
 CYLINDERS: 8 TYPE G-1  
 CREW: 6  
 YRR. 49. 1008 Z

Figure 4-8. Oxygen Duration

the chute. The spring-loaded handle on the top cover acts as a valve to relieve that vacuum.

4-67. OXYGEN SYSTEM.

4-68. GENERAL.

4-69. A low pressure oxygen system supplied by eight Type G-1 oxygen cylinders is installed in the airplane. The cylinders are located in the well in the center crew nacelle section. The complete oxygen system may be serviced through a single filler valve located in a recessed box in the underside of the crew nacelle just forward of the entrance hatch. Portable oxygen units and recharging facilities are provided in the crew nacelle. A pressure breathing diluter demand oxygen regulator, pressure gage, and flow indicator are installed at each crew station and at four alternate stations for the photo-technician.

4-70. OXYGEN SYSTEM CONTROLS.

4-71. REGULATOR DILUTER LEVER. A diluter lever is provided on each regulator to select "NORMAL OXYGEN" for all normal usages or to select "100% OXYGEN" for emergency use (see paragraph 4-78).

4-72. REGULATOR PRESSURE DIAL. A pressure dial is provided on each regulator to select safety pressure above 30,000 feet and pressure breathing above 40,000 feet.



4-73. OXYGEN SYSTEM INDICATORS.

4-74. PRESSURE GAGE. A pressure gage is installed at each station.

4-75. FLOW INDICATOR. A flow indicator is installed at each station.

4-76. OXYGEN SYSTEM NORMAL OPERATION.

4-77. The regulator diluter lever should be set at the "NORMAL OXYGEN" position. The pressure dial of the oxygen regulator should be set as follows:

- a. For cabin altitudes below 30,000 feet, leave dial at "NORMAL" position.
- b. For cabin altitudes between 30,000 and 40,000 feet, set the pressure dial at "SAFETY"

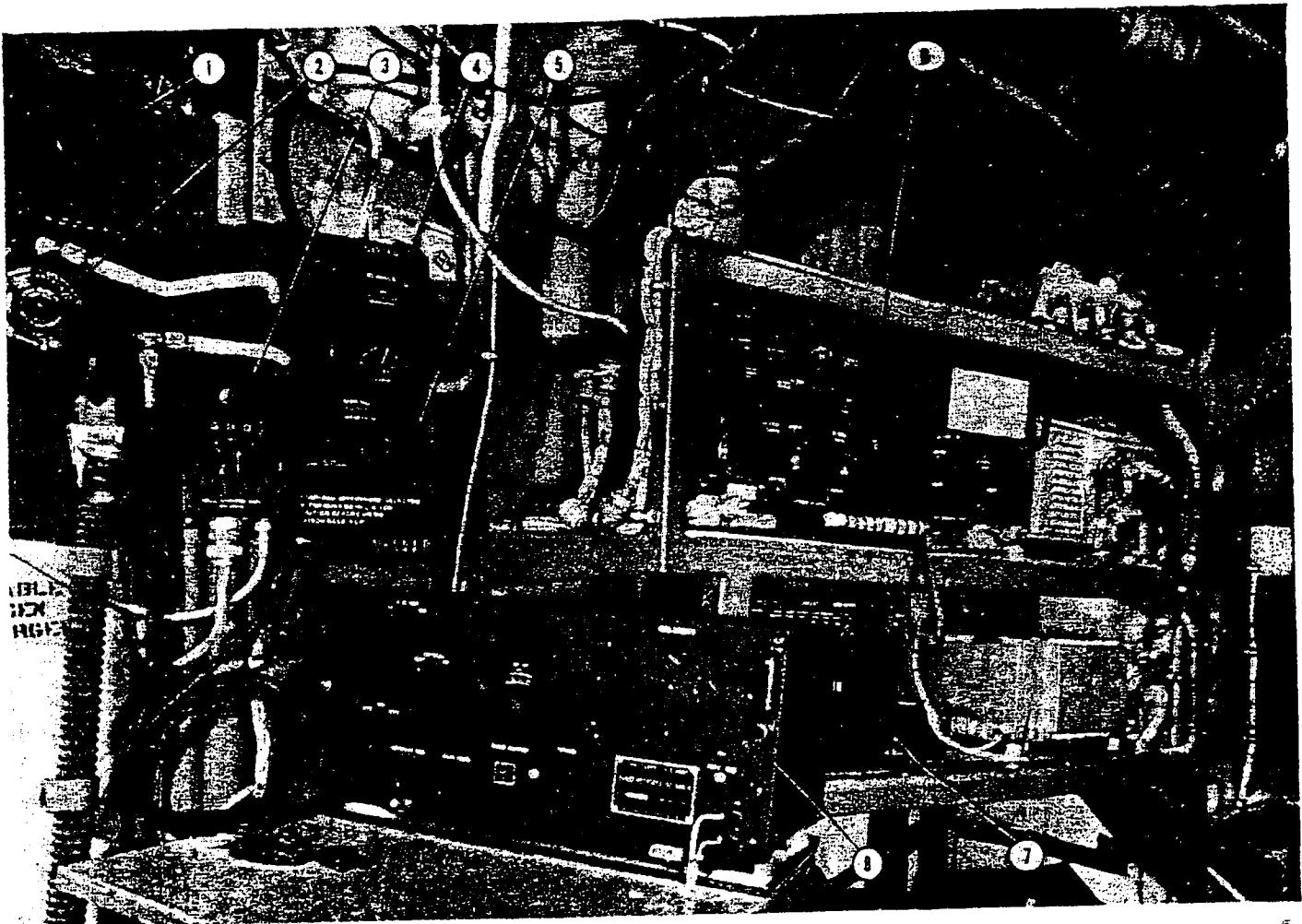

- |                                |                                     |
|--------------------------------|-------------------------------------|
| 1. HEATED CLOTHING CONTROL BOX | 5. INTERPHONE CONTROL PANEL         |
| 2. OXYGEN REGULATOR            | 6. ART-13 LIAISON RADIO TRANSMITTER |
| 3. ANTENNA REEL CONTROL BOX    | 7. RADIO JUNCTION BOX               |
| 4. OXYGEN GAGE PANEL           | 8. BC-348-Q LIAISON RADIO RECEIVER  |

YRB484 10051

Figure 4-9. Radio Operator's Station

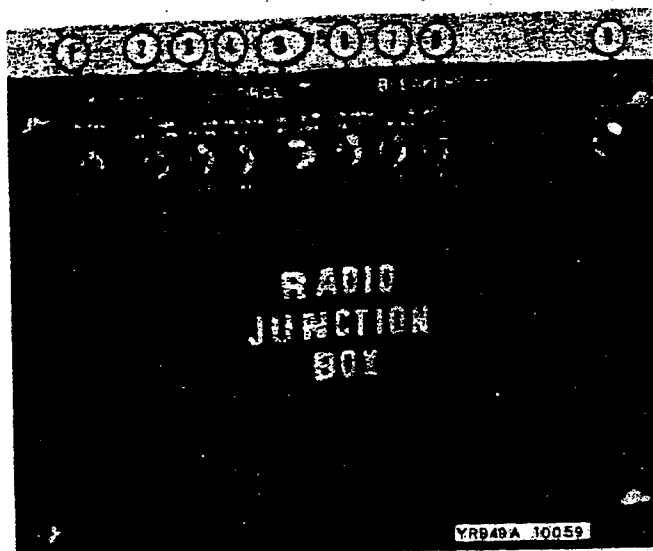

1. LIAISON RECEIVER NORMAL-MONITOR SELECTOR SWITCH
2. LIAISON RECEIVER CIRCUIT BREAKER
3. LIAISON TRANSMITTER CIRCUIT BREAKER
4. ANTENNA REEL CIRCUIT BREAKER
5. INTERPHONE CIRCUIT BREAKER
6. COMMAND RADIO CIRCUIT BREAKER
7. COMMAND RADIO CONTROL CIRCUIT BREAKER
8. COMMAND RADIO TEST CIRCUIT BREAKER
9. CABIN LIGHTS CIRCUIT BREAKER

Figure 4-10. Radio Junction Box

position.

c. For cabin altitudes above 40,000 feet, set the pressure dial to the cabin altitude.

4-78. OXYGEN SYSTEM EMERGENCY OPERATION.

4-79. With symptoms of the onset of anoxia or if smoke or fuel fumes should enter the cabin, set the diluter lever of the regulator to "100% OXYGEN."

CAUTION

When use of "100% OXYGEN" becomes necessary, the pilot will be informed of this action. Use of "100% OXYGEN" will reduce oxygen duration of the airplane. After the emergency is over, set the diluter lever to "NORMAL OXYGEN."

4-80. In the event of accidental loss of cabin pressure, immediately turn the pressure dial of the oxygen regulator to "ABOVE 45M" position and tighten mask to hold pressure.

4-81. If the oxygen regulator should become inoperative, disconnect the mask from the airplane oxygen system and connect it to a portable oxygen unit. If an adequately filled portable unit is not available, pull the cord of the H-2 emergency oxygen cylinder.

WARNING

When use of the H-2 emergency oxygen cylinder becomes necessary, the pilot will be informed of this action, so that he can immediately descend to an altitude at which oxygen is not required.

4-82. COMMUNICATION AND ASSOCIATED ELECTRONIC EQUIPMENT.

4-83. TABLE OF COMMUNICATION AND ASSOCIATED ELECTRONIC EQUIPMENT.

TYPE	DESIGNATION	USE	OPERATOR	RANGE
Interphone	AF Combat Interphone System	Intra-airplane communication	All crew members. Press-to-talk buttons on each control stick; foot-operated switch for photo-navigator, radar-navigator, and engineer; hand-operated switches in aft section for photo-technician	Audio Frequency
Command Radio	AN/ARC-3	Voice and code within 100-156 MC range	Pilots	Slightly greater than line of sight
Liaison Radio	AN/ARC-8	VHF voice and code	Pilots	2000 miles
Radar	APA-44	Ground position indicator	Radar-navigator	
Radar	APS-23	Used with APA-44	Radar-navigator	200 miles

TYPE	DESIGNATION	USE	OPERATOR	RANGE
Loran	APN-9	Radio direction finder	Radar-navigator	1200 to 1500 miles

4-84. INTERPHONE SYSTEM. The interphone system provides both normal and private interphone communication between all crew members. The private interphone circuit is provided so that the normal system may be open for the use of other crew members. To use the private interphone, first call on the normal system and then have those concerned switch to the "PVT. INTER." position. The circuit breaker (5, figure 4-10) for the system is located on the radio junction box at the radio operator's station. A ground crew interphone switch (27, figure 1-4) on the engineer's switch panel controls the interphone circuit to the ground crew jacks in the nose gear strut door.

4-85. COMMAND RADIO. A control panel (30, figure 1-20; 6, figure 1-24) for operation of the AN/ARC-3 Command Radio is installed on each pilot's pedestal. Each pilot is provided with a transmitter switch which allows either pilot to have control of the set. An indicator light adjacent to each switch indicates which pilot has control of the set. Three circuit breakers (6, 7, 8, figure 4-10) for the set are located on the radio junction box to the left of the copilot.

4-86. LIAISON RADIO. The AN/ARC-8 liaison radio may be controlled by either pilot. The receiver, transmitter, and trailing antenna control are located at the radio operator's station to the left of the copilot. A key for code transmission is mounted on the radio table. The pilot is provided with a transmitter control panel (31, figure 1-20) on his pedestal. The circuit breakers (2 and 3, figure 4-10) for the set are located on the radio junction box.

4-87. RADAR AND LORAN SETS. Radar sets APA-44 and APS-23 and Loran set APN-9 are installed in the airplanes. All controls for the operation of these sets are located at the radar-navigator's station.

#### 4-88. AIR CONDITIONING SYSTEM.

##### 4-89. GENERAL.

4-90. The entire crew nacelle can be ventilated with ram air from the airstream or with heated, compressed air from the engine compressor sections. Automatic temperature control is provided for operation of the heating and pressurizing system elements. Emergency controls are provided for shutting off the individual heating and ventilating systems on each side of the airplane, and an emergency control is provided for emergency depressurizing of the crew nacelle. Electric fans are installed throughout the crew nacelle to aid in circulating the air and defrosting the windows.

##### 4-91. AIR CONDITIONING SYSTEM CONTROLS.

4-92. All controls for the air conditioning system are located on the engineer's switch panel. The cabin air control circuit breaker

(8, figure 1-4) for the control circuits is on the upper section of the panel; the air supply and temperature control switches are at the bottom of the panel.

4-93. CABIN AIR SELECTOR SWITCH. The cabin air selector switch (21, figure 1-4) controls the air conditioning system shut-off valves and is used for selection of ram air or heated, compressed air. When the switch is in the "RAM AIR" position, the air ducts from the engine compressors are closed and the ram air intake valve and normal air dump valve are open. When the switch is moved to the "CABIN PRESSURE" position, the air ducts from the engine compressors are opened and the ram air intake and normal air dump valves are closed, placing cabin pressure under control of an automatic pressure regulator. When the switch is placed in the "EMER DUMP" position, the air valves operate to their ram air ventilating positions and, in addition, an emergency air dump valve is opened to aid in rapidly depressurizing the crew nacelle.

4-94. CABIN TEMPERATURE SELECTOR SWITCH. When the cabin air selector switch (21, figure 1-4) is in the "CABIN PRESSURE" position, the cabin temperature selector switch (23, figure 1-4) provides either automatic or manual control of the temperature of the air delivered to the crew nacelle. The center position of this switch is "OFF." When the switch is in the "AUTO." position, the air supply is automatically maintained at the temperature setting of the cabin air temperature rheostat (20, figure 1-4) located next to the cabin temperature selector switch. Manual control of the air temperature may be obtained by momentarily moving the cabin temperature selector switch to the "HEAT" or "COOL" positions and then returning it to the "OFF" position.

4-95. CABIN AIR TEMPERATURE RHEOSTAT. The cabin air temperature rheostat (20, figure 1-4) is used to set the automatic temperature control unit to maintain a desired air temperature when the cabin temperature selector switch is in the "AUTO." position.

4-96. CABIN AIR EMERGENCY SHUT-OFF SWITCHES. The cabin air emergency shut-off switches (25, figure 1-4) are provided so that the heated air from the engines on either side of the airplane may be shut off in the event of an emergency such as engine fire or malfunction of the system on one side of the airplane.

##### 4-97. AIR CONDITIONING SYSTEM INDICATORS.

4-98. CABIN ALTIMETER. A cabin altimeter (4, figure 1-5) on the engineer's center instrument panel indicates the cabin altitude. A white arc on the cover glass of the indicator indicates the range (8000 ± 300 feet) of cabin altitude it is desirable to maintain by cabin pressurization.

4-99. CABIN RATE OF CLIMB INDICATOR. The cabin

Section IV  
Paragraphs 4-99 to 4-112

rate of climb indicator (5, figure 1-5) indicates the rate of increase or decrease in cabin altitude.

4-100. CABIN ALTITUDE WARNING HORN. A cabin altitude warning horn in the forward crew nacelle section blows when the cabin altitude exceeds 12,000 feet, indicating that the cabin air pressure should be increased or oxygen should be used. An altitude warning switch (26, figure 1-4) controls the cabin altitude warning horn circuit.

4-101. AIR CONDITIONING SYSTEM NORMAL OPERATION.

a. To ventilate the crew nacelle with ram air, place the cabin air control switch in the "RAM AIR" position.

b. To heat and pressurize the crew nacelle, move the cabin air selector switch to the "CABIN PRESSURE" position, place the cabin temperature selector switch in "AUTO." position, and regulate the cabin temperature by setting the cabin air temperature rheostat. If manual control of the temperature is desired, leave the cabin temperature selector switch in the "OFF" position except for momentary deflections to the "HEAT" and "COOL" positions.

c. When changing cabin air control settings, do not exceed 300 feet per minute rate of change in cabin altitude, as indicated on the cabin rate of climb indicator.

4-102. AIR CONDITIONING SYSTEM EMERGENCY OPERATION.

a. If fumes or smoke from a fire in one wing enter the crew nacelle through the air conditioning system, turn off the corresponding cabin air emergency shut-off switch on the engineer's switch panel.

b. In the event of fire in the crew nacelle, leave the cabin air selector switch in "CABIN PRESSURE" position (keeping the ram air valve closed) and move both cabin air emergency shut-off switches to "OFF" position (shutting off the flow of pressurized air). This procedure will stop all air flow into the crew nacelle, and the switch settings should be maintained

4-112. TABLE OF INTERIOR LIGHTS AND SWITCHES.

only long enough to put the fire out with hand fire extinguishers. As soon as possible, air flow should again be admitted to the crew nacelle.

c. If it is necessary to bail out, the crew nacelle should be rapidly depressurized by moving the cabin air selector switch to the "EMER. DUMP" position, before attempting to release the astrodome and the upper escape hatch in the center crew nacelle compartment.

4-103. LIGHTING EQUIPMENT.

4-104. EXTERIOR LIGHTS.

4-105. Control switches and circuit breakers for all exterior lights are mounted on the pilot's pedestal. (See figure 1-20.)

4-106. EXTERIOR LIGHTS CONTROL SWITCHES.

4-107. LANDING LIGHTS SWITCH. A single, three-position landing light switch (20, figure 1-20) controls the extension, illumination, and retraction of the landing lights.

NOTE

When the engine-driven generators are not operating, the landing lights should not be operated for more than a few seconds, in order to conserve battery power.

4-108. FORMATION LIGHTS SWITCH. The formation lights switch (21, figure 1-20) has "BRIGHT," "DIM," and "OFF" positions.

4-109. NAVIGATION LIGHTS SWITCHES. There are two navigation lights switches (32, figure 1-20) for the navigation lights. One switch has "DIM" and "BRIGHT" positions; the other has "FLASH," "OFF," and "STEADY" positions.

4-110. FUSELAGE POSITION LIGHTS SWITCHES. A fuselage position lights switch (33, figure 1-20), with "BRIGHT," "OFF," and "DIM" positions, controls the fuselage position lights. A push-button type key switch (33, figure 1-20) is provided for the fuselage lights.

4-111. INTERIOR LIGHTS.

LIGHT TYPE AND LOCATION	NO. OF LIGHTS	SWITCH LOCATIONS
Dome lights:	3	On light panels
-forward section	1	On light panel
-center section	1	On light panel
-aft section	1	On light panel
-bomb bay	1	On bomb bay forward wall
Extension lights:	1	On light panel
-engineer's station	1	On light panel
-photo-navigator's station	1	On light panel
-radio operator's station	1	On light panel
Cockpit lights (incandescent):	8	On rear of lamp housings
-each crew station	1	On rear of lamp housing
-aft section	1	
Cockpit lights (ultraviolet):	7	On rear of lamp housings
-engineer's station	2	On rear of lamp housings
-radar-navigator's station	2	On rear of lamp housings

LIGHT TYPE AND LOCATION	NO. OF LIGHTS	SWITCH LOCATIONS
-photo-navigator's station -radio operator's station -aft section	1 2 1	On rear of lamp housing On rear of lamp housings On rear of lamp housing
Cockpit lights (fluorescent): -pilots' instrument panels -pilots' pedestals	2 2	On pedestals On pedestals
Table light: -radar-navigator's station	1	On oxygen panel
Interior lighting circuit breakers		Engineer's switch panel Pilot's pedestal Radio junction box Aft section light circuit breaker panel

4-113. ICE ELIMINATION EQUIPMENT.

4-114. GENERAL.

4-115. Equipment for the elimination of ice on external components of the airplane includes: leading edge anti-icing systems, pilot's windshield de-icing and de-fogging systems, pitot tube heaters, and a ram air scoop heater.

4-116. LEADING EDGE ANTI-ICING SYSTEMS.

4-117. The eight individual leading edge anti-icing systems use heated and pressurized air from the compressor sections of the engines. Four systems on each side of the airplane heat the leading edges of the outer wing panels, air intake duct lips, vertical stabilizers, and engine pods. When the systems are in use, they are under automatic control. An overheat protection thermostat in each system operates to close off the system should an overheat condition occur. A pressure controller unit in each system provides protection against excessive pressure. The controls and indicators for the systems are located on the engineer's switch panel.

4-118. LEADING EDGE ANTI-ICING SYSTEMS CONTROLS AND INDICATORS

4-119. ANTI-ICING SYSTEMS CIRCUIT BREAKER. An anti-icing systems circuit breaker (28, figure 1-4) on the engineer's switch panel protects the electrical circuits for all eight leading edge anti-icing systems.

4-120. ANTI-ICING SYSTEM SWITCHES. Eight anti-icing system switches (16, figure 1-4), one for each system, are located on the engineer's switch panel. The individual systems are put into operation by moving the control switches to the "AUTO" positions.

4-121. ANTI-ICING SYSTEMS OVERHEAT WARNING LIGHTS. An anti-icing system overheat warning light (15, figure 1-4) for each hot air anti-icing system indicates when an overheat condition exists in the individual system. Illumination of one of the lights indicates that the automatic overheat protection unit of the system has closed off the system.

4-122. OPERATION OF LEADING EDGE ANTI-ICING SYSTEMS.

4-123. To put the leading edge anti-icing systems into operation:

a. Make sure that anti-icing systems circuit breaker is pushed in, otherwise none of the systems can operate.

b. Place individual anti-icing system switches in "AUTO" positions.

c. If an anti-icing system overheat warning light comes on and remains on over 30 seconds, turn that system off until light goes out. Then, if anti-icing is needed, turn system on again.

4-124. PILOT'S WINDSHIELD DE-ICING AND DE-FOGGING SYSTEMS.

4-125. Two ac electrical circuits are employed for de-icing and de-fogging the pilot's windshield. Both systems have thermo-film elements located between the windshield plate sections. The de-icing circuit directs current through the outer, high temperature, thermo-film element for de-icing the outside of the windshield. The de-fogging circuit directs current through the inner, lower temperature, thermo-film element for de-fogging the inside of the windshield.

4-126. PILOT'S WINDSHIELD DE-ICING AND DE-FOGGING SYSTEMS CONTROLS. A windshield de-icing switch (11, figure 1-20), a windshield de-fogging switch (10, figure 1-20), and a circuit breaker (9, figure 1-20) for these systems are installed on the pilot's pedestal. The windshield de-icing switch has three positions - "OFF," "HIGH," and "LOW." When operating the windshield de-icing element, the windshield de-icing switch should be placed in "LOW" position for a few minutes before placing it in the "HIGH" position. The windshield de-fogging switch has "ON" and "OFF" positions.

4-127. PITOT TUBE HEATERS.

4-128. The pitot tube heads incorporate electrical heating elements.

4-129. PITOT HEATERS CIRCUIT BREAKER SWITCH. A pitot heaters circuit breaker switch (32, figure 1-4), on the engineer's switch panel, controls the pitot tube heater circuits.

4-130. FLIGHT CONTROL FORCE SCOOP HEATER.

- 4-131. The air scoop from which ram air pressure is delivered to the elevator force bellows incorporates a dc resistance-type heater element.
- 4-132. FLIGHT CONTROL FORCE SCOOP HEATER SWITCH. The flight control force scoop heater switch (22, figure 1-4) is located at the bottom of the engineer's switch panel.
- 4-133. MISCELLANEOUS OPERATIONAL EQUIPMENT.
- 4-134. GENERAL.
- 4-135. The location of miscellaneous stowed equipment is shown in the general arrangement diagram (see figure 1-2). This equipment includes spare lamps, spare limiters, jack pads, mooring equipment, and airplane reference material.
- 4-136. WINDSHIELD WIPERS.
- 4-137. One hydraulically-actuated windshield wiper is provided for the pilot's windshield and one electrically-actuated wiper is provided for the photo-navigator's window in the leading edge. The pilot's windshield wiper receives hydraulic pressure from the brakes and steering hydraulic system. For this reason, the wiper can be operated only when the landing gear is down or when the engineer's hydraulic brake pump manual override switch is on.
- 4-138. PILOT'S WINDSHIELD WIPER CONTROL. The pilot's windshield wiper control, located just above the pilot's instrument panel, operates a valve which regulates the flow of hydraulic fluid to the wiper mechanism and controls its speed of operation.
- 4-139. PHOTO-NAVIGATOR'S WINDSHIELD WIPER CIRCUIT BREAKER SWITCH. The photo-navigator's windshield wiper circuit breaker switch (7, figure 1-20) is located on the pilot's pedestal.
- 4-140. CABIN FANS.
- 4-141. Eight 208-volt ac fans (not including the camera window fans) are used to circulate air within the crew nacelle. One fan is installed at each crew station and two fans are installed in the aft section. An on-off switch is located adjacent to each fan. A limiter installation for the cabin fans circuit is located behind the engineer's instrument panel.
- 4-142. HEATED CLOTHING EQUIPMENT.
- 4-143. Suit heater control boxes are located at each crew station, as follows: pilot's, mounted on a brace at the right-hand side of the seat; copilot's, mounted on the panel to the left of the yoke; photo-navigator's, mounted on the right-hand cabin wall; radar-navigator's, mounted at the left side of the table; engineer's, mounted on the right-hand wall beneath the table; radio operator's, mounted on the left-hand wall over the table. In addition, one is installed in the center section and one in the aft section for the alternate photo-technician stations. The suit heater control boxes operate on 24-volts ac and have plug-in receptacles and rheostat knobs for voltage control.
- 4-144. RELIEF TUBE.
- 4-145. A relief tube is installed in the center crew nacelle section. It is held in place by a clip attached to the aft face of the oxygen tank well.
- 4-146. CHEMICAL TOILET.
- 4-147. A chemical toilet is installed in the aft crew nacelle section.
- 4-148. ENTRANCE LADDER.
- 4-149. A ladder is provided for use at the entrance hatch. When not in use, the ladder is telescoped and strapped to brackets on the aft side of the oxygen tank well.
- 4-150. DATA CASE.
- 4-151. A data case is attached to the cabin wall to the left of the pilot.
- 4-152. FLIGHT REPORT HOLDER.
- 4-153. The container for the pilot's flight report is located on the right-hand side of the pilot's seat.
- 4-154. WATER CONTAINERS.
- 4-155. Two 6.2-quart drinking water containers are located on the forward face of the oxygen tank well. A drinking cup dispenser is mounted alongside the containers.
- 4-156. HOT CUPS.
- 4-157. Two hot cups are located on a support bracket on the left-hand side of the center crew nacelle section. The cups are electrically heated, and the heating current is controlled by a switch located adjacent to the cups.
- 4-158. SPARE LAMPS.
- 4-159. An adequate supply of spare lamps is carried in boxes mounted on the left-hand side of the center crew nacelle section.
- 4-160. LOOSE PARTS.
- 4-161. Loose parts kits are stowed in an equipment box located on the floor aft of the chemical toilet in the aft crew nacelle section.

APPENDIX I  
OPERATING CHARTS

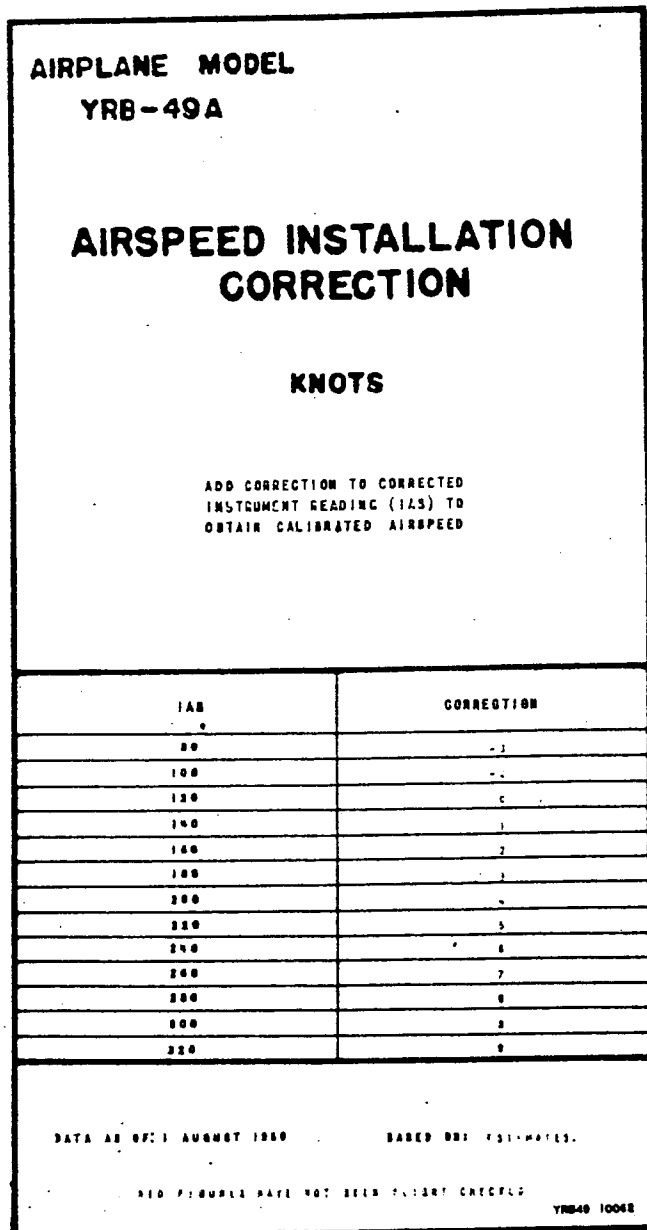

Figure A-1. Airspeed Installation  
Correction

RESTRICTED  
AN 01-15EBB-1

AIRCRAFT MODEL  
YRB-49A

ENGINE MODEL  
J35-A-19

**AIRSPED COMPRESSIBILITY CORRECTION**  
KNOTS

SUBTRACT CORRECTION FROM CALIBRATED AIRSPEED  
TO OBTAIN EQUIVALENT AIRSPEED

PRESSURE ALTITUDE FT.	CA S - KNOTS											
	100	120	140	160	180	200	220	240	260	280	300	320
SEA LEVEL	0	0	0	0	0	0	0	0	0	0	0	0
5,000	0	0	0	0	0	1	1	1	1	1	2	2
10,000	0	0	0	1	1	1	2	2	2	3	3	4
15,000	0	1	1	2	2	3	4	4	6	7	8	9
20,000	0	1	1	2	3	4	5	5	8	9	11	13
25,000	0	1	2	3	4	5	7	8	11	12	15	18
30,000	1	1	2	3	4	5	7	9	11	13	16	20
35,000	1	2	3	4	5	7	9	11	14	17	21	
40,000	1	2	4	5	7	9	11	14	18	22		
45,000	2	3	5	6	9	11	14	18	22			
50,000	2	4	6	8	11	14	18	22				

BASED ON STANDARD FORMULA

DATA AS OF 1 AUGUST 1950

REMARKS

1. DIVIDE EQUIVALENT AIRSPEED BY  $\sqrt{\sigma}$  TO OBTAIN TRUE AIRSPEED (WHERE  $\sigma$  IS RELATIVE AIR DENSITY).

YRB49 10063

Figure A-2. Airspeed Compressibility Correction

RESTRICTED





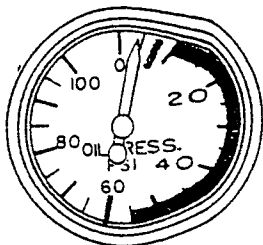

OIL PRESSURE GAGE

- 75 PSI MINIMUM FOR FLIGHT
- 10-55 PSI CONTINUOUS OPERATION
- 60 PSI MAXIMUM

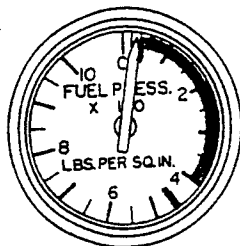

FUEL PRESSURE GAGE

- 50 PSI MINIMUM FOR FLIGHT
- 50-400 PSI NORMAL
- 450 PSI MAXIMUM

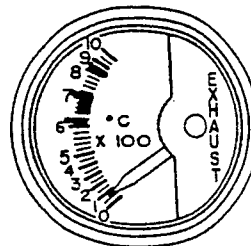

EXHAUST TEMPERATURE GAGE

- 640°C MINIMUM FOR FLIGHT
- 640-713°C CONTINUOUS OPERATION
- 713°C MAXIMUM FOR FLIGHT
- 897°C MAXIMUM DURING STARTING AND ACCELERATION ONLY

FUEL GRADE  
JP-3

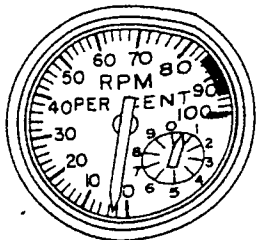

TACHOMETER

- 85-95% BEST CRUISING
- 100% MAXIMUM

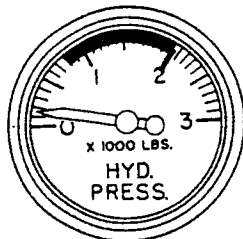

POWER SURFACE CONTROL SYSTEM  
HYDRAULIC PRESSURE GAGE

- 800-2000 PSI NORMAL
- 2050 PSI MAXIMUM

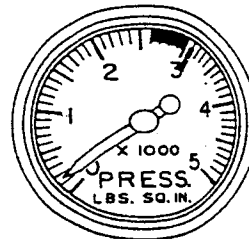

NOSE GEAR STEERING  
HYDRAULIC PRESSURE GAGE

- 1000 PSI ONE BRAKE APPLICATION REMAINING
- 2600-3000 PSI NORMAL
- 3100 PSI MAXIMUM

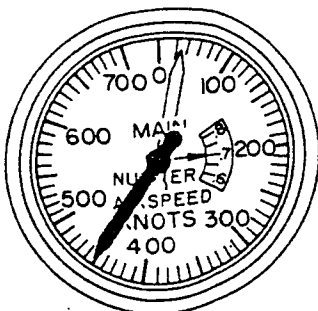

PILOT'S AND COPILOT'S AIRSPEED INDICATORS

- 139 KNOTS MAXIMUM FULL FLAPS
- (152 KNOTS MAXIMUM LANDING GEAR)
- THE INSTRUMENT SETTING IS SUCH THAT THE RED POINTER WILL MOVE TO INDICATE THE AIRSPEED REPRESENTING THE LIMITING MACH NO OF .7.
- LIMITING STRUCTURAL AIRSPEEDS ARE SHOWN IN FIGURE 2-4.

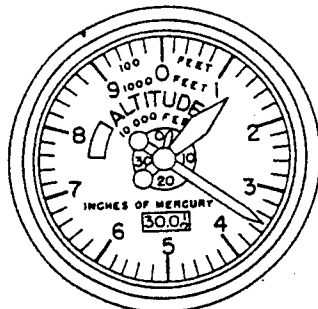

CABIN ALTIMETER

- (WHITE) 8000 FT. ± 300 FT.
- ALTITUDE MEAN CABIN PRESSURE

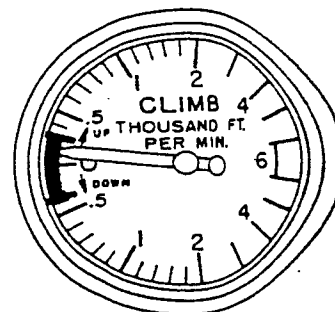

CABIN RATE OF CLIMB INDICATOR

- ± 300 FT./MIN. MAXIMUM RATE OF CABIN PRESSURE CHANGE
- ± 0-300 FT./MIN. OPERATING RANGE

1849A 10056

Figure A-4 (Sheet 1 of 2 sheets). Instrument Markings

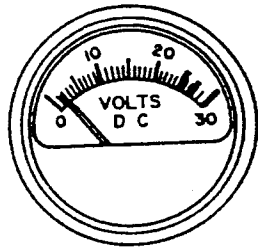

VOLTMETER D C

- 25.0 VOLTS MINIMUM
- 27.5 VOLTS CONTINUOUS OPERATION
- 30.0 VOLTS MAXIMUM

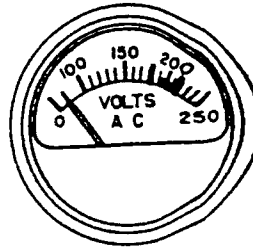

VOLTMETER A C

- 180 VOLTS MINIMUM
- 190-210 VOLTS CONTINUOUS OPERATION
- 210 VOLTS MAXIMUM

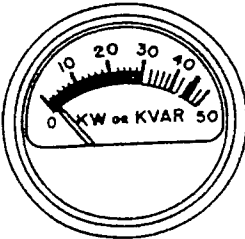

WATT VARMETER

- 0-30 KW CONTINUOUS OPERATION
- 45 KW MAXIMUM (5 MINUTES)

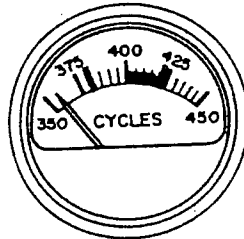

FREQUENCY METER

- 380 CYCLES MINIMUM
- 400-420 CYCLES CONTINUOUS OPERATION
- 420 CYCLES MAXIMUM

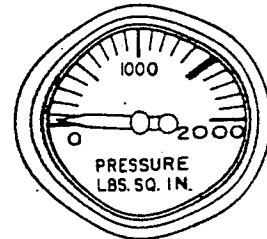

EMERGENCY AIR BRAKE  
AIR PRESSURE GAGE

- 1500 PSI NORMAL CHARGING PRESSURE

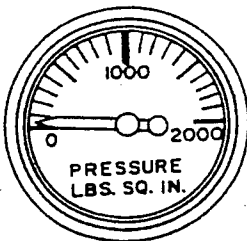

NOSE GEAR DOOR BUNGEE  
AIR PRESSURE GAGE

- 1000 PSI NORMAL CHARGING PRESSURE

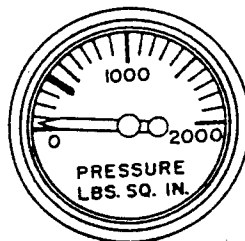

NOSE LANDING GEAR BUNGEE  
AIR PRESSURE GAGE

- 400 PSI NORMAL CHARGING PRESSURE

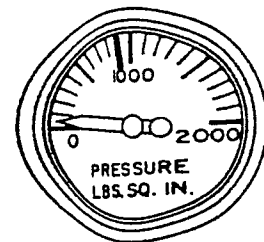

MAIN LANDING GEAR BUNGEE  
AIR PRESSURE GAGE

- 900 PSI NORMAL CHARGING PRESSURE

YRF-49A 10057

Figure A-4 (Sheet 2 of 2 sheets). Instrument Markings

A-1. FLIGHT OPERATION INSTRUCTION CHARTS.

A-2. GENERAL.

A-3. The Flight Operation Instruction Charts (see figures A-11, A-12, and A-13) show the range of the airplane at long range airspeeds and the procedure required to obtain this range. On the line opposite available fuel in the upper half of each chart, two range values are shown for each initial altitude. One range value is for continued flight at the initial altitude and the other for the maximum range obtainable by climbing to optimum altitude. The charted ranges do not include fuel consumed or distance covered during warm-up, take-off, and initial climb at the start of the flight, but do include fuel used and distance covered during in-flight climb to optimum altitude and during descent at the end of flight.

A-4. The lower half of each chart presents the operating procedure to obtain the ranges quoted. When altitude is changed, operating instructions in the column for the new altitude must be used if the ranges listed are to be obtained.

A-5. Under different wind conditions, ranges (in ground miles) are varied by the affect of wind on ground speed. Recommended CAS may also change to maintain the best ground miles per gallon. To facilitate range computation under wind conditions, the lower half of each chart contains operating instructions for various winds at each altitude listed. When flying in a wind, ground miles are obtained by multiplying chart air miles by the range factor found opposite the effective wind at the cruising altitude.

A-6. The approximate rpm and CAS values quoted on any one chart are based on the gross weight equal to the highest weight of the chart weight band. If the recommended values of CAS are maintained, the rpm values will decrease slightly as gross weight decreases.

A-7. The fuel and distance allowances for in-flight climb to optimum altitude are based on the heaviest weight on each chart and are for military power operation at maximum rate of climb. Descent allowances are based on the lightest weight on each chart and are for idling power operation at the speed for maximum range.

A-8. USE OF THE CHARTS.

A-9. PREFLIGHT RANGE PLANNING.

A-10. Select the applicable Flight Operation Instruction Chart. Determine the amount of fuel available for flight planning. Available fuel is equal to the total amount in the airplane before starting the engines, minus the amount needed for warm-up, taxi, take-off, initial climb, and necessary reserves. Select

a. Assumed cruise altitude	20,000 ft	25,000 ft
b. Range factor	1.0	0.8
Given wind at assumed altitude		
c. Air distance in climb to assumed altitude	64 n mi	93 n mi
From Climb Chart, figure A-8		

a figure in the fuel column equal to, or less than, the amount available for flight planning. Interpolate if desired.

A-11. To determine maximum range at a given altitude, move horizontally right or left to the desired altitude column. Multiply the still air range value thus obtained by the correct range factor, and add the distance covered in initial climb to obtain total range with a given wind and altitude. Fly according to the instructions in the lower half of the chart.

A-12. IN-FLIGHT RANGE PLANNING.

A-13. To use the charts in flight, first determine altitude, available fuel, and effective wind. Available fuel is equal to the fuel on board minus necessary reserves. Enter the appropriate Flight Operation Instruction Chart at a fuel quantity equal to, or less than, the available fuel. Move horizontally right or left to the applicable altitude column.

A-14. From the ranges and wind factors listed, determine the altitude at which the flight is to be continued. For continued cruising at the initial altitude, fly according to the instructions directly below. When changing charts, refer to cruising instructions on the new chart at the same altitude.

A-15. To obtain the range shown at optimum altitude, climb immediately according to the recommended climb procedure for military power. For cruising instructions at the new altitude, refer to the lower half of the chart in the column under the new altitude. When changing charts, refer to the cruising instructions on the new chart at the new altitude.

A-16. SAMPLE PROBLEM.

A-17. To illustrate the use of the charts in flight planning, suppose the airplane must be ferried 1600 nautical miles. For unexpected difficulties a general reserve of 1000 gallons of fuel is considered necessary. The initial, known conditions are as follows:

Required Range	1600 n mi
Effective winds	0-knot headwind at 20,000 ft and below
	50-knot headwind above 25,000 ft
Minimum flight weight	88,755 lbs.

A-18. A preliminary inspection of the Flight Operation Instruction Charts shows that approximately 12,000 gallons of fuel will be required and this will place the gross weight in the 175,000 - 145,000 pound weight band. From the Climb Chart, figure A-8, and the Flight Operation Instruction Chart for this weight band, figure A-11, the following data are obtained:

d. Ground distance in climb c x b (approximate)	64 n mi	74 n mi
e. Ground distance remaining to cruise and descend 1600 - d	1536 n mi	1526 n mi
f. Air distance to cruise and descend e + b	1536 n mi	1908 n mi
g. Fuel required to cruise and descend Interpolated value from Flight Operation Instruction Chart, figure A-11	9019 gal	10,730 gal
h. Fuel required in initial climb From Climb Chart, figure A-8	1272 gal	1555 gal
i. Fuel reserve	1000 gal	1000 gal
j. Total fuel required g + h + i	11,281 gal	13,285 gal
k. Take-off gross weight 88,755 + total fuel weight at 6.5 lb/gal	162,082 lbs	175,108 lbs

A-19. It is seen that, due to the headwind, constant altitude cruise at 25,000 feet is impossible because the required take-off gross weight exceeds the normal maximum gross

weight. The flight could be made at 20,000 feet. Note, however, that if the flight is made at optimum altitude the data will be as follows:

Optimum Altitude

f. Air distance to cruise and descend	1908 n mi
g. Fuel required to cruise and descend From Flight Operation Instruction Chart, figure A-11 (conservative)	9000 gal
j. Total fuel required g + h + i	11,555 gal
k. Take-off gross weight	163,863 lbs

A-20. Therefore, the flight can be made at either constant altitude cruise at 20,000 feet or at optimum altitude cruise with a slight increase in take-off weight due to the headwind. The engine settings and cruise airspeed

will be found in either case in the lower half of the Flight Operation Instruction Chart which includes the airplane gross weight, under the applicable altitude, and on line with the effective wind.

AIRPLANE MODEL YRB-49A		TAKE-OFF DISTANCE FEET										ENGINE MODEL J36-A-19	
		0 DEG. FLAPS		10 DEG. CENT.		20 FOOT WIND		30 DEG. CENT.		40 DEG. CENT.		50 DEG. CENT.	
WEIGHT LB	PRECEDENCE ALTIMETER FT.	30 FOOT WIND		30 DEG. CENT.		40 DEG. CENT.		50 DEG. CENT.		60 DEG. CENT.		70 DEG. CENT.	
		WIND 0000 50 FT.	WIND 0000 50 FT.	WIND 0000 50 FT.	WIND 0000 50 FT.	WIND 0000 50 FT.	WIND 0000 50 FT.	WIND 0000 50 FT.	WIND 0000 50 FT.	WIND 0000 50 FT.	WIND 0000 50 FT.	WIND 0000 50 FT.	WIND 0000 50 FT.
1000	1100	2100	2100	2100	2100	2100	2100	2100	2100	2100	2100	2100	2100
2000	1100	2200	2200	2200	2200	2200	2200	2200	2200	2200	2200	2200	2200
3000	1100	2300	2300	2300	2300	2300	2300	2300	2300	2300	2300	2300	2300
4000	1100	2400	2400	2400	2400	2400	2400	2400	2400	2400	2400	2400	2400
5000	1100	2500	2500	2500	2500	2500	2500	2500	2500	2500	2500	2500	2500
6000	1100	2600	2600	2600	2600	2600	2600	2600	2600	2600	2600	2600	2600
7000	1100	2700	2700	2700	2700	2700	2700	2700	2700	2700	2700	2700	2700
8000	1100	2800	2800	2800	2800	2800	2800	2800	2800	2800	2800	2800	2800
9000	1100	2900	2900	2900	2900	2900	2900	2900	2900	2900	2900	2900	2900
10000	1100	3000	3000	3000	3000	3000	3000	3000	3000	3000	3000	3000	3000
11000	1100	3100	3100	3100	3100	3100	3100	3100	3100	3100	3100	3100	3100
12000	1100	3200	3200	3200	3200	3200	3200	3200	3200	3200	3200	3200	3200
13000	1100	3300	3300	3300	3300	3300	3300	3300	3300	3300	3300	3300	3300
14000	1100	3400	3400	3400	3400	3400	3400	3400	3400	3400	3400	3400	3400
15000	1100	3500	3500	3500	3500	3500	3500	3500	3500	3500	3500	3500	3500
16000	1100	3600	3600	3600	3600	3600	3600	3600	3600	3600	3600	3600	3600
17000	1100	3700	3700	3700	3700	3700	3700	3700	3700	3700	3700	3700	3700
18000	1100	3800	3800	3800	3800	3800	3800	3800	3800	3800	3800	3800	3800
19000	1100	3900	3900	3900	3900	3900	3900	3900	3900	3900	3900	3900	3900
20000	1100	4000	4000	4000	4000	4000	4000	4000	4000	4000	4000	4000	4000
21000	1100	4100	4100	4100	4100	4100	4100	4100	4100	4100	4100	4100	4100
22000	1100	4200	4200	4200	4200	4200	4200	4200	4200	4200	4200	4200	4200
23000	1100	4300	4300	4300	4300	4300	4300	4300	4300	4300	4300	4300	4300
24000	1100	4400	4400	4400	4400	4400	4400	4400	4400	4400	4400	4400	4400
25000	1100	4500	4500	4500	4500	4500	4500	4500	4500	4500	4500	4500	4500
26000	1100	4600	4600	4600	4600	4600	4600	4600	4600	4600	4600	4600	4600
27000	1100	4700	4700	4700	4700	4700	4700	4700	4700	4700	4700	4700	4700
28000	1100	4800	4800	4800	4800	4800	4800	4800	4800	4800	4800	4800	4800
29000	1100	4900	4900	4900	4900	4900	4900	4900	4900	4900	4900	4900	4900
30000	1100	5000	5000	5000	5000	5000	5000	5000	5000	5000	5000	5000	5000
31000	1100	5100	5100	5100	5100	5100	5100	5100	5100	5100	5100	5100	5100
32000	1100	5200	5200	5200	5200	5200	5200	5200	5200	5200	5200	5200	5200
33000	1100	5300	5300	5300	5300	5300	5300	5300	5300	5300	5300	5300	5300
34000	1100	5400	5400	5400	5400	5400	5400	5400	5400	5400	5400	5400	5400
35000	1100	5500	5500	5500	5500	5500	5500	5500	5500	5500	5500	5500	5500
36000	1100	5600	5600	5600	5600	5600	5600	5600	5600	5600	5600	5600	5600
37000	1100	5700	5700	5700	5700	5700	5700	5700	5700	5700	5700	5700	5700
38000	1100	5800	5800	5800	5800	5800	5800	5800	5800	5800	5800	5800	5800
39000	1100	5900	5900	5900	5900	5900	5900	5900	5900	5900	5900	5900	5900
40000	1100	6000	6000	6000	6000	6000	6000	6000	6000	6000	6000	6000	6000
41000	1100	6100	6100	6100	6100	6100	6100	6100	6100	6100	6100	6100	6100
42000	1100	6200	6200	6200	6200	6200	6200	6200	6200	6200	6200	6200	6200
43000	1100	6300	6300	6300	6300	6300	6300	6300	6300	6300	6300	6300	6300
44000	1100	6400	6400	6400	6400	6400	6400	6400	6400	6400	6400	6400	6400
45000	1100	6500	6500	6500	6500	6500	6500	6500	6500	6500	6500	6500	6500
46000	1100	6600	6600	6600	6600	6600	6600	6600	6600	6600	6600	6600	6600
47000	1100	6700	6700	6700	6700	6700	6700	6700	6700	6700	6700	6700	6700
48000	1100	6800	6800	6800	6800	6800	6800	6800	6800	6800	6800	6800	6800
49000	1100	6900	6900	6900	6900	6900	6900	6900	6900	6900	6900	6900	6900
50000	1100	7000	7000	7000	7000	7000	7000	7000	7000	7000	7000	7000	7000

DATA AS OF: 1 AUGUST 1950

BASED ON: ESTIMATES

REMARKS

1. USE 100% RPM.

2. DURING APPROX. HOLD WINDS OF AROUND 100,000 LB. 50 MP. UNTIL APPROXIMATELY THE FOLLOWING CALL 115,000 LB. 61 MP. 100,000 LB. 70 MP. 175,000 LB. 80 MP.

3. WEIGHTS IN EXCESS OF 100,000 LB. MUST BE SPECIFICALLY AUTHORIZED BY AWC

4. EXCESS WEIGHTS MUST NOT BE EXCEEDED

FUEL GRADE: JP-3 AT 6.5 LBS./U.S.GAL.

YRB49A 10072

Figure A-5. Take-off Distance

AIRPLANE MODEL

ENGINE MODEL

YRB-49A

J35-A-19

LANDING DISTANCE

50 DEG. FLAPS - HARD SURFACE RUNWAY

GROSS WEIGHT LB.	BEST APPROACH C A S KM.		NO WIND							
	POWER ON	POWER OFF	SEA LEVEL		2000 FT. ALT.		4000 FT. ALT.		6000 FT. ALT.	
			GROUND ROLL	CLEAR 50 FT.	GROUND ROLL	CLEAR 50 FT.	GROUND ROLL	CLEAR 50 FT.	GROUND ROLL	CLEAR 50 FT.
100,000	112	115	2170	2990	2170	3140	2250	3270	2330	3410
125,000	108	111	2450	3410	2540	3570	2590	3730	2700	3830
150,000	113	117	2710	3870	2820	4040	2950	4210	3090	4380

DATA AS OF: 1 AUGUST 1950

BASED ON: ESTIMATES

FUEL GRADE: JP-3 AT 6.5 LB./U.S. GAL.

REMARKS

- USE IDLING POWER (APPROXIMATELY 575 RPM)
- CHART DISTANCES ARE BASED ON NORMAL TECHNIQUE AT ICAO STANDARD TEMPERATURE
- LAND AT THE FOLLOWING CAS:
 

100,000 LB.	92	KT.
125,000 LB.	81	KT.
150,000 LB.	100	KT.
- SET DOWN NOSE WHEEL AND APPLY BRAKES BEFORE APPROXIMATELY THE FOLLOWING CAS:
 

100,000 LB.	73	KT.
125,000 LB.	51	KT.
150,000 LB.	40	KT.

RED FIGURES HAVE NOT BEEN FLIGHT CHECKED

YRB49A 10073

Figure A-6. Landing Distance

AIRCRAFT MODEL  
YRB-49A

ENGINE MODEL  
J35-A-19

FUEL FLOW CHART

NACA STANDARD DAY

ALTITUDE FT.	FUEL FLOW GAL/MIN.	
	100+ RPM	95+ RPM
	64	76
S.L.	70	84
5,000	75	90
10,000	80	97
15,000	84	103
20,000	87	108
25,000	90	113
30,000	93	118
35,000	96	123
40,000		

DATA AS OF: 1 AUGUST 1950

ESTIMATED.  
BASED ON:

FUEL GRADE: JP-3 AT 8.5 LB./U.S.GAL.

REMARKS

- FUEL FLOWS HAVE BEEN INCREASED 5% FOR SERVICE VARIATIONS.

RED FIGURES HAVE NOT BEEN FLIGHT CHECKED

YRB49 10049

Figure A-7. Fuel Flow Chart  
RESTRICTED



**AIRPLANE MODEL**  
**YRB-49A**

**CLIMB CHART**  
STANDARD DAY

**ENGINE MODEL**  
**J35-A-19**

1005 RPM				C A S MPH	PRESSURE ALTITUDE FT.	955 RPM				
APPROXIMATE						C A S MPH	APPROXIMATE			RATE OF CLIMB FT./MIN.
RATE OF CLIMB FT./MIN.	FROM SEA LEVEL						FROM SEA LEVEL			
	AIR DISTANCE N. M.	TIME MIN.	FUEL GAL.	FUEL GAL.	TIME MIN.	AIR DISTANCE N. M.				

AIRPLANE TAKE-OFF GROSS WEIGHT 175,000 TO 145,000 LB.

			(3)	SEA LEVEL		(3)				
2000	0	0	350	254	5,000	221	330	C	C	1500
1800	0	0	350	254	10,000	222	301	A	22	1110
1600	0	0	350	254	15,000	212	281	B	32	1110
1400	0	0	350	254	20,000	202	126	13	37	1300
1200	0	0	350	254	25,000	196	142	20	30	1650
1000	0	0	350	254	30,000	185	1780	29	125	410
800	0	0	350	254	35,000					
					40,000					
					45,000					
					50,000					
					55,000					

AIRPLANE TAKE-OFF GROSS WEIGHT 145,000 TO 115,000 LB.

			(3)	SEA LEVEL		(3)				
2400	0	0	355	232	5,000	227	335	D	C	210
2200	0	0	355	232	10,000	218	301	3	17	1690
2000	0	0	355	232	15,000	208	271	8	20	1680
1800	0	0	355	232	20,000	199	333	10	29	1740
1600	0	0	355	232	25,000	190	1136	14	38	1050
1400	0	0	355	232	30,000	181	1394	20	32	740
1200	0	0	355	232	35,000	172	1620	28	121	490
1000	0	0	355	232	40,000	163	2097	42	189	250
					45,000					
					50,000					
					55,000					

AIRPLANE TAKE-OFF GROSS WEIGHT 115,000 TO 85,000 LB.

			(3)	SEA LEVEL		(3)				
3400	0	0	355	232	5,000	211	355	D	C	2400
3200	0	0	355	232	10,000	215	300	2	6	1530
2800	0	0	355	232	15,000	208	692	5	17	2060
2600	0	0	355	232	20,000	195	780	7	23	1790
2400	0	0	355	232	25,000	186	924	10	31	1450
2200	0	0	355	232	30,000	177	1073	15	38	1180
2000	0	0	355	232	35,000	167	1325	19	30	890
1800	0	0	355	232	40,000	158	1418	26	110	570
1600	0	0	355	232	45,000	147	1713	42	168	240
					50,000					
					55,000					

FUEL GRADE: JP-3 AT 8.5 LB./U.S. GAL.

DATA AS OF: 1 AUGUST 1950. BASED ON: ESTIMATES

**REMARKS**

- EXHAUST TEMPERATURE AND TIME LIMITS:  
MILITARY POWER 712°C 30 MIN.  
NORMAL POWER 640°C UNLIMITED
- CLIMB AT CAS SHOWN REGARDLESS OF AMBIENT TEMPERATURE.
- ALLOWANCE FOR TAXI, TAKEOFF, AND ACCELERATION TO CLIMB CAS.
- FUEL, TIME, AND DISTANCE ARE CORRECTED FOR VARIATION OF DENSITY ENERGY WITH ALTITUDE.
- FUEL CONSUMPTION INCREASED 5% TO ALLOW FOR SERVICE VARIATIONS.

WEIGHTS IN EXCESS OF 165,000 LB. MUST BE SPECIFICALLY AUTHORIZED BY AWC

RED FIGURES HAVE NOT BEEN FLIGHT CHECKED

YRB49 10665

Figure A-8. Climb Chart  
RESTRICTED

AIRPLANE MODEL

**DESCENT CHART**

ENGINE MODEL

TO SEA LEVEL AT IDLING POWER

**YRB-49A**

**J35-A-19**

GROSS WEIGHT 145,000 LB.

APPROXIMATE					CAS KTS.	PRESSURE ALTITUDE FT.	SIX ENGINES OPERATING					
RATE OF DESCENT FT./MIN.	TO SEA LEVEL			ENGINE SPEED S RPM			CAS KTS.	ENGINE SPEED S RPM	TO SEA LEVEL			RATE OF DESCENT FT./MIN.
	AIR DISTANCE N.M.I.	TIME MIN.	FUEL GAL.						FUEL GAL.	TIME MIN.	AIR DISTANCE N.M.I.	
						55,000						
						50,000						
						45,000						
						40,000						
						35,000						
						30,000	184	72	555	30.9	142	984
						25,000	182	68	484	31.0	115	951
						20,000	181	62	413	25.2	80	950
						15,000	179	57	342	19.6	58	910
						10,000	185	67	286	12.9	46	825
						5,000	189	57	142	6.0	23	772
						SEA LEVEL	197	57	0	0	0	719

DATA AS OF: 1 AUGUST 1960      BASED ON: ESTIMATED      FUEL GRADE: JP-3 AT 6.5 LB. / U.S. GAL.

REMARKS

- DESCEND AT IDLING POWER AND CAS SHOWN. (IDLING ENGINE SPEEDS ARE THOSE LISTED.)
- WITH ALL ENGINES OPERATIVE, MAXIMUM-DISTANCE DESCENT DATA ARE AS FOLLOWS:  
CAS                      160 KTS.  
AIR DISTANCE        14 N.M.I. PER 5,000 FT. ALT.
- FUEL, TIME, AND DISTANCE ARE CORRECTED FOR VARIATION OF KINETIC ENERGY WITH ALTITUDE.
- FUEL CONSUMPTION INCREASED 5% TO ALLOW FOR SERVICE VARIATIONS.

SEE PLANNER HAVE NOT BEEN FLIGHT CHECKED

YRB-49 10066

Figure A-9 (Sheet 1 of 3 sheets). Descent Chart



AIRPLANE MODEL

**DESCENT CHART**

ENGINE MODEL

**YRB-49A**

TO SEA LEVEL AT IDLING POWER

**J35-A-19**

GROSS WEIGHT 85,000 LB.

ONE ENGINE OPERATING					PRESSURE ALTITUDE FT.	SIX ENGINES OPERATING						
APPROXIMATE TO SEA LEVEL				CAS KTS.		CAS KTS.	APPROXIMATE TO SEA LEVEL			RATE OF DESCENT FT./MIN.		
RATE OF DESCENT FT./MIN.	AIR DISTANCE N.M.I.	TIME MIN.	FUEL GAL.				ENGINE SPEED RPM	FUEL GAL.	TIME MIN.		AIR DISTANCE N.M.I.	
					55,000							
					50,000							
					45,000							
					40,000	154	80	1012	73.1	278	412	
					35,000	156	75	872	61.1	215	312	
					30,000	153	72	756	51.0	175	381	
					25,000	160	68	645	41.7	137	515	
					20,000	157	62	540	33.1	104	69	
					15,000	154	57	442	25.1	78	67	
					10,000	162	57	333	17.2	53	61	
					5,000	170	57	188	8.4	20	500	
					SEA LEVEL	180	57	0	0	0	550	

DATA AS OF: 1 AUGUST 1950

BASED ON: ESTIMATED

FUEL GRADE: JP-3 AT 6.5 LB./U.S. GAL

REMARKS

- DESCEND AT IDLING POWER AND CAS SHOWN. (IDLING ENGINE SPEEDS ARE THOSE LISTED)
- WITH ALL ENGINES INOPERATIVE, MAXIMUM-DISTANCE DESCENT DATA ARE AS FOLLOWS:

CAS 1218.  
AIR DISTANCE 148-NM. PER 5,000 FT. ALT.

- FUEL, TIME, AND DISTANCE ARE CORRECTED FOR VARIATION OF KINETIC ENERGY WITH ALTITUDE.
- FUEL CONSUMPTION INCREASED 5% TO ALLOW FOR SERVICE VARIATIONS.

RED FIGURES HAVE NOT BEEN FLIGHT CHECKED

YRB49 10066

Figure A-9 (Sheet 3 of 3 sheets). Descent Chart

AIRCRAFT MODEL  
YRB-49A

ENGINE MODEL  
J35-A-19

# LONG RANGE CRUISE CHART

HACA STANDARD DAY

GROSS WEIGHT	OPTIMUM ALTITUDE	RPM	CAS	FUEL FLOW	N.M.I. PER 1540 GAL. FUEL
LB.	FT.	S	KN.	U. S. GAL./HR.	
175,000	25,000	92	221	2091	266
165,000	27,000	92	227	1958	276
155,000	29,000	92	230	1830	295
145,000	31,000	92	233	1702	320
135,000	33,000	92	237	1574	346
125,000	35,000	91	194	1458	380
115,000	37,000	91	196	1338	405
105,000	39,000	91	177	1213	440
95,000	41,000	91	180	1121	490
85,000	43,000	91	162	1020	

DATA AS OF: 1 AUGUST 1960

DATA BASED ON: ESTIMATES

FUEL GRADE: JP-2 AT 6.5 LB. / U. S. GAL.

REMARKS

1. FUEL CONSUMPTION INCREASED 5% FOR SERVICE VARIATIONS.

EXAMPLE

IF YOU ARE AT A STARTING GROSS WEIGHT OF 155,000 LB., INCLUDING 65,000 LB. (10,000 GAL.) OF FUEL, START CRUISE AT 29,000 FT. AT 925 RPM AND 230 KN. CAS. FOR THE FIRST 1540 GAL. OF FUEL CONSUMED THE RANGE WILL BE 295 N.M.I. THE GROSS WEIGHT WILL BE DECREASED TO 140,000 LB. 50 FOR THE SECOND 1540 GAL. OF FUEL CRUISE AT 31,000 FT. AT 925 RPM AND 233 KN. CAS. THE RANGE FOR THIS WILL BE 320 N.M.I. FOR THE THIRD, 346 N.M.I.; ETC. THE FINAL ALTITUDE WILL BE 43,000 FT. FOR A GROSS WEIGHT OF 90,000 LB. THE TOTAL RANGE, ASSUMING NO CLIMB OR LET-DOWN FUEL, WILL BE 2630 N.M.I. THE FUEL AND DISTANCES FOR CLIMB AND LET-DOWN, MAY BE TAKEN FROM THE FLIGHT OPERATIONS CHARTS.

WEIGHTS IN EXCESS OF 105,000 LB. MUST BE SPECIFICALLY AUTHORIZED BY AIC

RED FIGURES HAVE NOT BEEN FLIGHT CHECKED

YRB49 10070

Figure A-10. Long Range Cruise Chart

AIRPLANE MODEL YRB-49A			FLIGHT OPERATION INSTRUCTION CHART			EXTERNAL LOAD ITEMS NONE								
ENGINE: J35-A-19			CHART WEIGHT LIMITS: 175,000 TO 145,000 LB.			NUMBER OF ENGINES OPERATING: SIX								
LIMITS			INSTRUCTIONS FOR USING CHART											
RATING	EXHAUST	TEMP.	<p>(4) IN FLIGHT, select figure in fuel column equal to or less than fuel on board. Move horizontally, right or left to section pertaining to present altitude and read total range available (no wind) by cruising at this altitude or by climbing to and cruising at the optimum altitude. For cruise at the present altitude, follow operating instructions given for this altitude. For cruise at the optimum altitude, climb immediately to that altitude and follow the operating instructions tabulated for that altitude.</p> <p>(5) FLIGHT PLANNING. Subtract fuel required for take-off and climb to altitude. Then use chart as for 10 FLIGHT above, reading initial climb distance to range values.</p>											
	AFTER-BURNER	% RPM												
MAXIMUM	NOT	100	710	30										
MILITARY	APPLICABLE	100	710	30										
NORMAL		95	890	UNLIMITED										
<b>LOW ALTITUDE</b>														
IF YOU ARE AT SEA LEVEL			IF YOU ARE AT 5,000 FT.			IF YOU ARE AT 10,000 FT.			IF YOU ARE AT 15,000 FT.			IF YOU ARE AT 20,000 FT.		
RANGE IN AIRMILES			RANGE IN AIRMILES			RANGE IN AIRMILES			RANGE IN AIRMILES			RANGE IN AIRMILES		
BY CRUISING AT 5,000 FT. OPT. ALT. 1000 FT. AT OPT. ALT.			BY CRUISING AT 5,000 FT. OPT. ALT. 1000 FT. AT OPT. ALT.			BY CRUISING AT 10,000 FT. OPT. ALT. 1000 FT. AT OPT. ALT.			BY CRUISING AT 15,000 FT. OPT. ALT. 1000 FT. AT OPT. ALT.			BY CRUISING AT 20,000 FT. OPT. ALT. 1000 FT. AT OPT. ALT.		
1370			1643			1691			1937			2194		
1253			1434			1458			1889			2151		
1189			1328			1517			1752			1987		
1075			1222			1415			1615			1842		
972			1114			1294			1477			1686		
878			1010			1172			1340			1522		
783			901			1047			1197			1372		
FUEL GAL.			FUEL GAL.			FUEL GAL.			FUEL GAL.			FUEL GAL.		
10,200			10,200			10,200			10,200			10,200		
12,000			12,000			12,000			12,000			12,000		
11,000			11,000			11,000			11,000			11,000		
10,000			10,000			10,000			10,000			10,000		
8000			8000			8000			8000			8000		
7000			7000			7000			7000			7000		
6000			6000			6000			6000			6000		
5000			5000			5000			5000			5000		
4000			4000			4000			4000			4000		
3000			3000			3000			3000			3000		
2000			2000			2000			2000			2000		
1000			1000			1000			1000			1000		
EFFECTIVE WIND			EFFECTIVE WIND			EFFECTIVE WIND			EFFECTIVE WIND			EFFECTIVE WIND		
100 MW			100 MW			100 MW			100 MW			100 MW		
50 MW			50 MW			50 MW			50 MW			50 MW		
0			0			0			0			0		
50 TW			50 TW			50 TW			50 TW			50 TW		
100 TW			100 TW			100 TW			100 TW			100 TW		
APPROXIMATE LET RANGE PER 1000 FT. DIST. FACTOR			APPROXIMATE LET RANGE PER 1000 FT. DIST. FACTOR			APPROXIMATE LET RANGE PER 1000 FT. DIST. FACTOR			APPROXIMATE LET RANGE PER 1000 FT. DIST. FACTOR			APPROXIMATE LET RANGE PER 1000 FT. DIST. FACTOR		
0			0			0			0			0		
0.1			0.1			0.1			0.1			0.1		
1.0			1.0			1.0			1.0			1.0		
1.2			1.2			1.2			1.2			1.2		
1.4			1.4			1.4			1.4			1.4		

Figure A-11 (Sheet 1 of 2 sheets). Flight Operation Instruction Chart - 175,000 to 145,000 Pounds Gross Weight - Low Altitude









AIRPLANE MODEL NONE			FLIGHT OPERATION INSTRUCTION CHART			EXTERNAL LOAD ITEMS NONE								
ENGINE: J35-A-19			CHART WEIGHT LIMITS 115,000 TO 85,000 LB.			NUMBER OF ENGINES OPERATING: 5-1X								
LIMITS			INSTRUCTIONS FOR USING CHART			IMPORTANCE								
RATING	AFTER-BURNER	EXHAUST TIME	(A) IN FLIGHT. Select figure in fuel column equal to or less than fuel on board. Move horizontally right or left to section pertaining to present altitude and read total range available (see wind) by cruising at this altitude or by climbing to and cruising at the optimum altitude. For cruise at the present altitude, follow operating instructions given for this altitude. For cruise at the optimum altitude, climb necessarily to that altitude and follow the operating instructions tabulated for that altitude.			Range shown at optimum altitudes are maximum. In other altitudes range on flights requiring the use of more than one chart (due to changes in external configuration and/or gross weight), the optimum altitude specified on each chart must be maintained while that chart is applicable. Fuel, in excess from the conditions of one chart to that of another. A climb may be required. Where such climbs are involved, climb distance and fuel are incorporated in the range values.								
MAXIMUM	NOT APPLICABLE	713 30	(B) FLIGHT PLANNING. Subtract fuel required for take-off and climb to altitude. Then see chart as for IN FLIGHT above, adding initial climb distance to range values.			All range values include allowances for descent distance and fuel (to sea level), but no reserve for landing and contingencies.								
MILITARY	APPLICABLE	713 30												
NORMAL		UNLIMITED												
LOW ALTITUDE														
IF YOU ARE AT SEA LEVEL			IF YOU ARE AT 5,000 FT.			IF YOU ARE AT 10,000 FT.			IF YOU ARE AT 15,000 FT.			IF YOU ARE AT 20,000 FT.		
RANGE IN AIRMILES			RANGE IN AIRMILES			RANGE IN AIRMILES			RANGE IN AIRMILES			RANGE IN AIRMILES		
BY CRUISING AT S.L.	OPT. ALT. 1000 FT.	BY CRUISING AT OPT. ALT.	BY CRUISING AT 5,000 FT.	OPT. ALT. 1000 FT.	BY CRUISING AT OPT. ALT.	BY CRUISING AT 10,000 FT.	OPT. ALT. 1000 FT.	BY CRUISING AT OPT. ALT.	BY CRUISING AT 15,000 FT.	OPT. ALT. 1000 FT.	BY CRUISING AT OPT. ALT.	BY CRUISING AT 20,000 FT.	OPT. ALT. 1000 FT.	BY CRUISING AT OPT. ALT.
500	35,000	1092	577	35,000	1143	777	35,000	1140	800	35,000	1188	855	35,000	1188
600	35,000	853	540	35,000	814	623	35,000	918	900	35,000	939	716	35,000	939
700	35,000	596	348	35,000	646	470	35,000	670	2000	35,000	691	540	35,000	691
800	35,000	338	236	35,000	358	216	35,000	422	2000	35,000	444	363	35,000	444
900	35,000	137	119	35,000	159	182	35,000	173	1800	35,000	188	188	35,000	188
EFFECTIVE WIND			EFFECTIVE WIND			EFFECTIVE WIND			EFFECTIVE WIND			EFFECTIVE WIND		
270	0	100 MW	272	0	100 MW	266	0	100 MW	259	0	100 MW	250	0	100 MW
276	0	50 MW	272	0	50 MW	281	0	50 MW	268	0	50 MW	238	0	50 MW
280	0	0	248	0	0	238	0	0	229	0	0	221	0	0
227	76	50 TW	228	76	50 TW	219	80	1900	212	82	1720	207	83	1870
318	78	100 TW	211	77	100 TW	206	78	1770	200	80	1620	187	82	1680

Figure A-13 (Sheet 1 of 2 sheets). Flight Operation Instruction Chart - 115,000 to 85,000 Pounds Gross Weight - Low Altitude



RESTRICTED  
AN 01-15EBB-1

APPENDIX II  
SPECIAL DATA

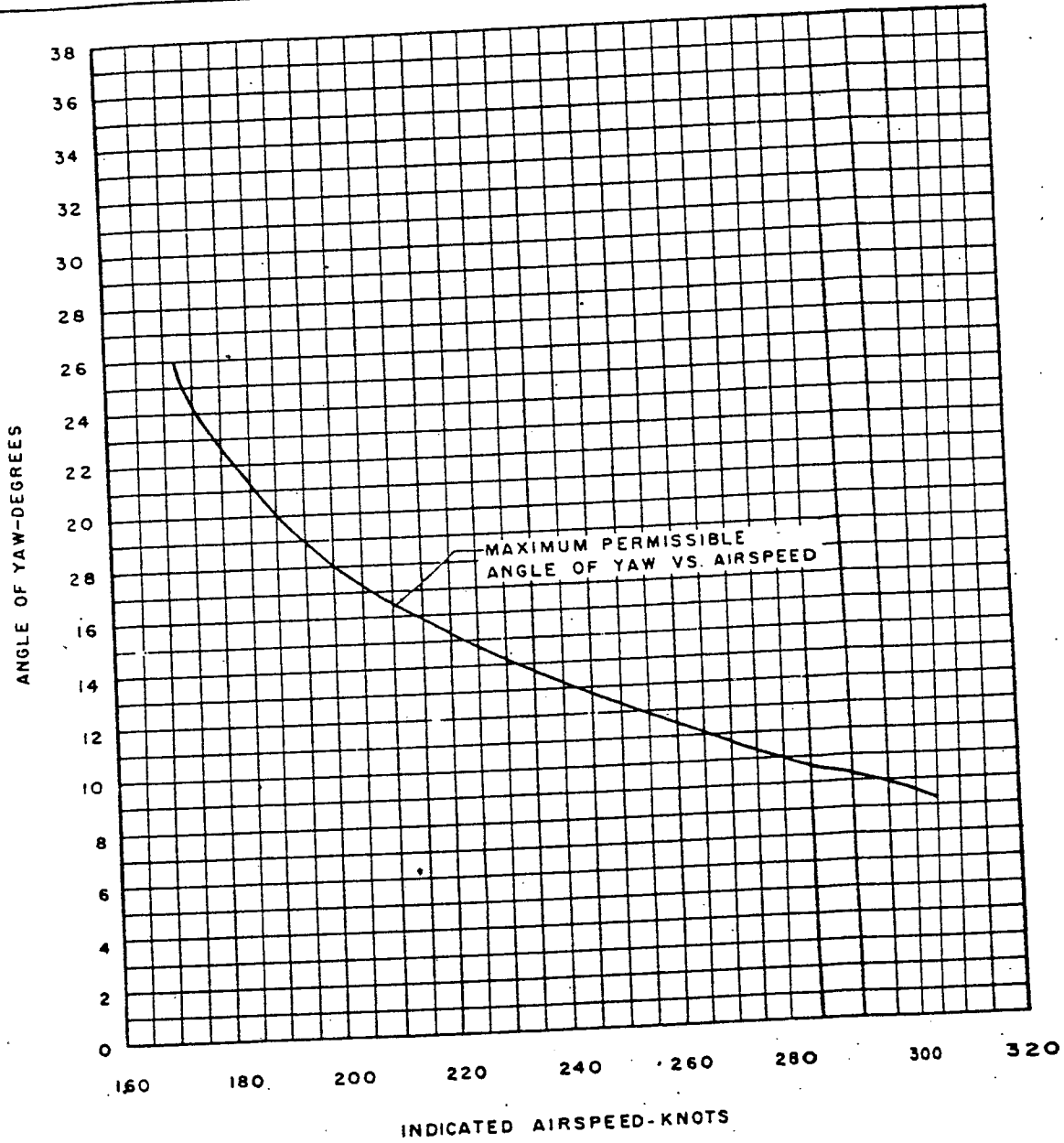

**NOTES:**

1. BEFORE USING THIS CURVE, THE PILOT'S OBSERVED AIRSPEED READING MUST BE CORRECTED FOR INSTRUMENT ERROR.
2. CURVE APPLIES AT ALL ALTITUDES AND ALL WEIGHTS.

Figure B-1. Angle of Yaw vs Airspeed Restrictions

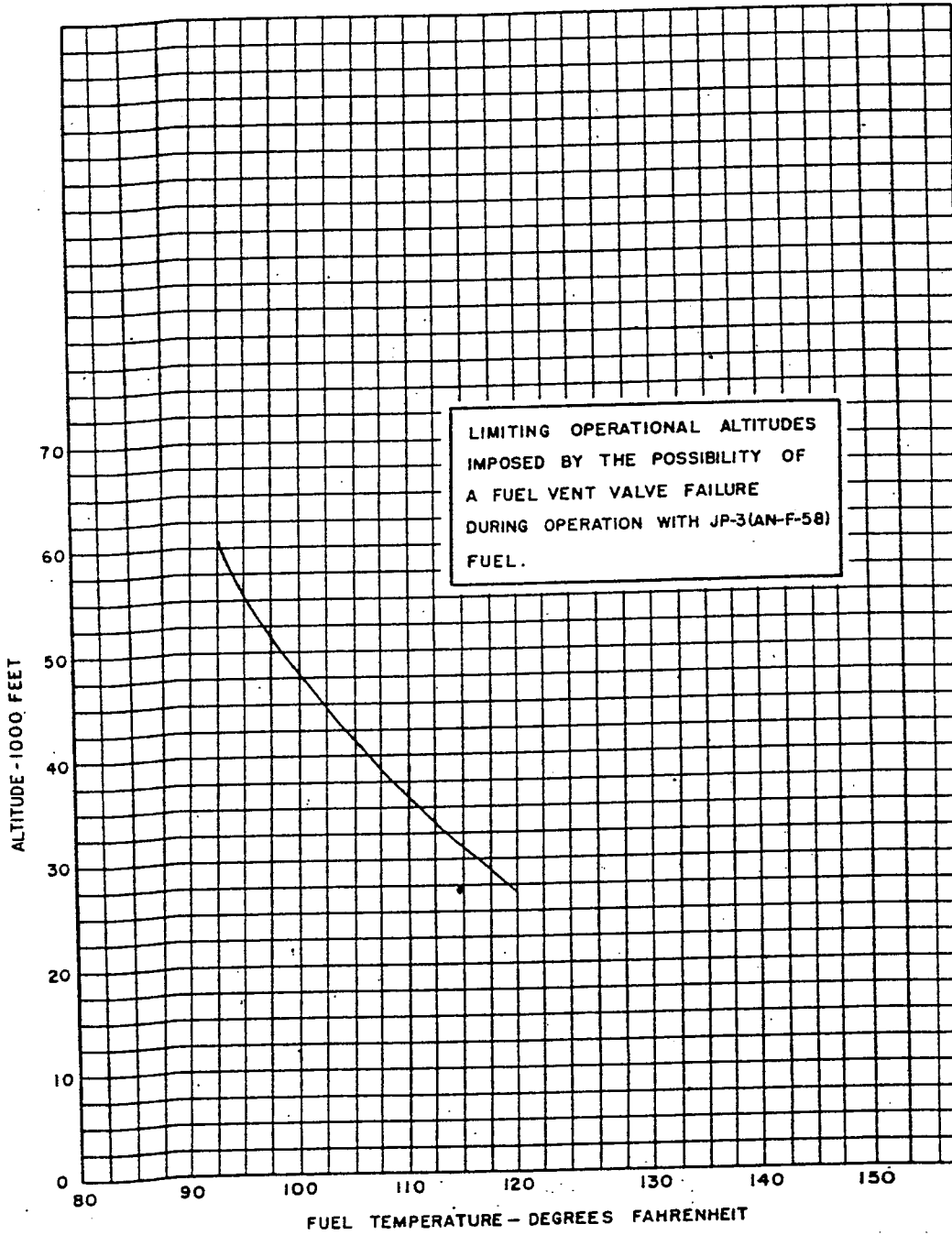

YR49A 10007

Figure B-2. Altitude Restrictions  
RESTRICTED

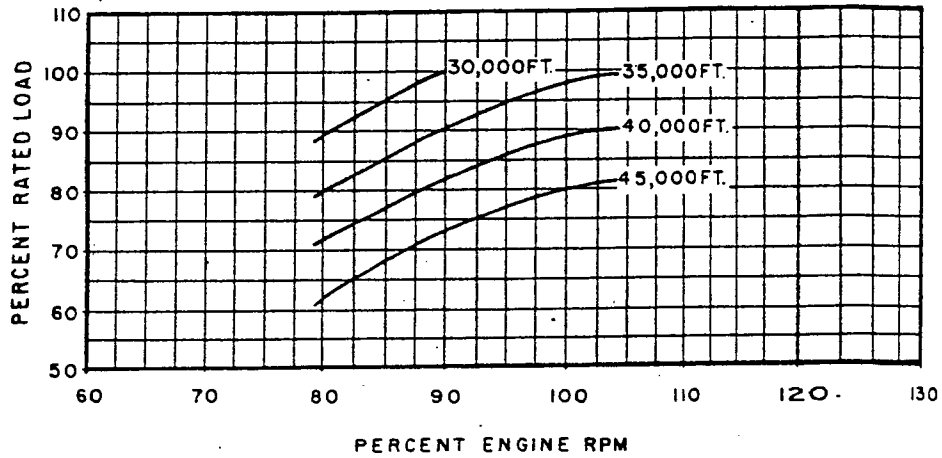

YR849A 10058

Figure B-3. Alternator and Starter-Generator Load Restrictions

