

A Century of Excellence in Measurements, Standards, and Technology

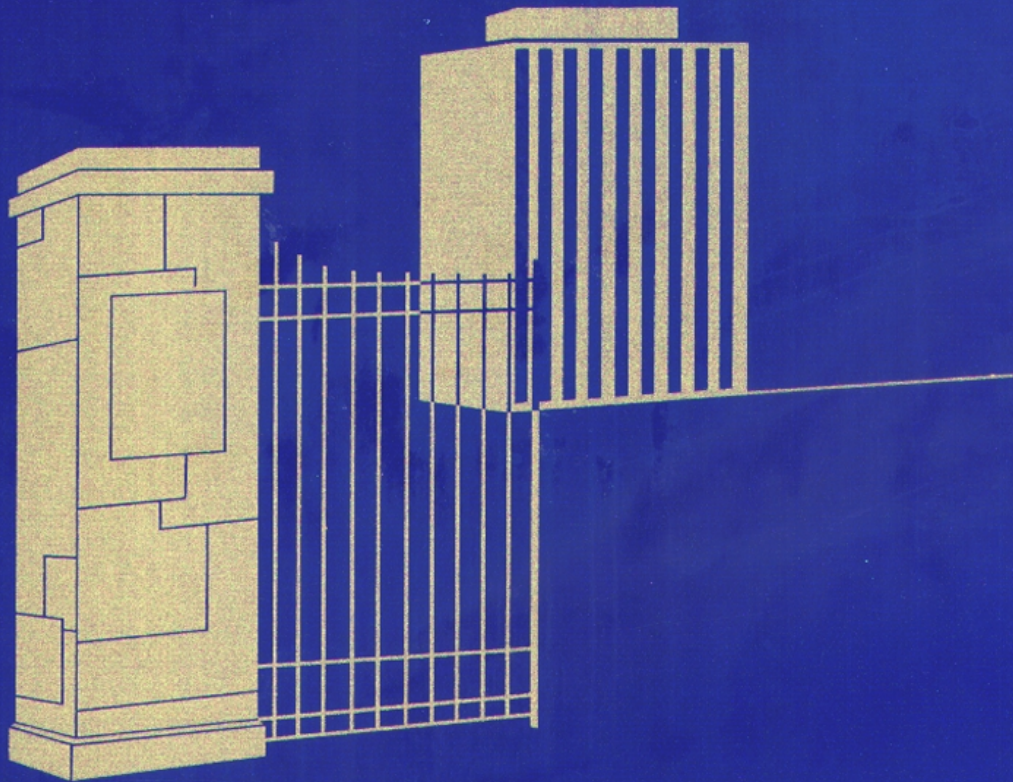

A Chronicle of Selected NBS/NIST Publications, 1901-2000

NIST Special Publication 958



**National Bureau of
Standards**

NIST

**National Institute of
Standards and Technology**
Technology Administration
U.S. Department of Commerce

A Century of Excellence in Measurements, Standards, and Technology

A Chronicle of Selected NBS/NIST Publications

1901-2000

NIST Special Publication 958

David R. Lide, Editor

January 2001



U.S. Department of Commerce

Donald L. Evans, Secretary

National Institute of Standards and Technology

Karen H. Brown, Acting Director



NIST

In this volume, according to NIST policy, measurements are expressed in SI units except in some cases where reference is made to the conventional units used at the time of the original publications.

Certain commercial equipment, instruments, or materials are identified in this paper to foster understanding. Such identification does not imply recommendation or endorsement by the National Institute of Standards and Technology, nor does it imply that the materials or equipment identified are necessarily the best available for the purpose.

Foreword

As NIST celebrates its 100th birthday and we look back at what has been accomplished, the variety of NIST's contributions to science and technology and to the economy of our nation is truly remarkable. This book, which consists of vignettes describing some of the classic publications from our first century, can only sample that variety. For every publication included, there were numerous others of comparable worth that had to be left out.

Few if any of the world's technical institutions have had such an eclectic, yet essential, evolving mission—from testing concrete and railroad track scales to quasicrystals and Nobel Prize-winning work on laser cooling of atoms; from developing radio beacons for aircraft navigation to building early computers for data processing and developing sophisticated models for the spread of fires. It is difficult to find any area of science and technology in which NIST/NBS has not played some important role.

The talented staff who work for NIST take pride in their work. Communicating results to the public is a critical task for us. While publication of paper documents will undoubtedly be around for some time to come, electronic publication via the World Wide Web is already a key vehicle for NIST to distribute information quickly. No doubt Internet-based dissemination of our information will continue to grow in importance.

Given the skill, enthusiasm, and dedication of our current staff, I feel confident that this splendid institution will produce an even greater contribution to the United States during the next hundred years. I am particularly proud to have had the opportunity to be at the helm of NIST as we transition into the 21st Century. And our recent employee survey shows that the vast majority of NIST people are equally proud to work here.

Enjoy browsing this book. It is a tribute to the men and women who have served NIST with distinction since 1901.

Raymond G. Kammer
Director

December 2000

Centennial Publication Selection Committee

The following individuals served on the Committee that developed the criteria for selecting publications to be included in this volume. The Committee solicited nominations, selected the publications to be included from the approximately 450 nominations that were submitted, and coordinated the preparation of short accounts of the chosen publications:

- Brian Belanger, Director's Office (Chair)
- Walter Leight, Technology Services (Vice Chair)
- Ronald Boisvert, Information Technology Laboratory
- Susan Makar, Office of Information Services
- John Mayo-Wells, Electronics and Electrical Engineering Laboratory
- Ronald Munro, Materials Science and Engineering Laboratory
- Dale Newbury, Chemical Science and Technology Laboratory
- Hans J. Oser, Standards Alumni Association
- Daniel Pierce, Physics Laboratory
- H. Steffen Peiser, Standards Alumni Association
- Dennis Swyt, Manufacturing Engineering Laboratory
- W. Reeves Tilley, Standards Alumni Association
- Richard Wright, Building and Fire Research Laboratory

Acknowledgments

Subcommittees Representing the Operating Units of NIST

Building and Fire Research Laboratory

Richard Wright, Chair
Jack Snell
James Hill
Andrew Fowell
Joel Zingesser
Harold Marshall
Karen Perry
Sivaraj Shyam-Sunder
Geoffrey Frohnsdorff
George Kelly
David Evans
Richard Gann
William Grosshandler

Chemical Science and Technology Laboratory

Dale E. Newbury, Chair
Charles M. Beck II
William R. Kelly
William J. Gadzuk
Roger D. Van Zee

Electronics and Electrical Engineering Laboratory

John Mayo-Wells, Chair
Norman B. Belecki
Jack Ekin
Douglas L. Franzen
Clark Hamilton
David A. Hill
Dave Rudman
Richard L. Steiner
W. Robert Thurber
Harry A. Schafft
Thomas R. Scott

Information Technology Laboratory

Ronald Boisvert, Chair
Martha Gray
John Cugini
M. Carroll Croarkin
Gordon Lyon

Manufacturing Engineering Laboratory

Dennis Swyt, Chair
Theodore Doiron
Donald Eitzen
Ernest Kent
Charles McLean

Materials Science and Engineering Laboratory

Ronald Munro, Chair
Norman Berk
Sam Coriell
Freddy Khoury

Physics Laboratory

Daniel T. Pierce, Chair
Charles W. Clark
Bert M. Coursey
James E. Faller
Albert C. Parr
Donald B. Sullivan
Wolfgang L. Wiese

Technology Services

Walter Leight, Chair
Charles Ehrlich
Ernest Garner
John Rumble
Charles Sturrock
Nancy Trahey

Standards Alumni Association

H. Steffen Peiser, Chair
John A. Bennett
Edith L. R. Corliss
Walter J. Hamer
John D. Hoffman
Ralph P. Hudson
Robert Kamper
Hans J. Oser
Jacob Rabinow
John A. Simpson
W. Reeves Tilley

List of Vignette Contributors

James S. Albus	Daniel Gross	Anita O'Brien
Charles M. Beck II	Walter J. Hamer	Dianne P. O'Leary
Brian Belanger	Carol Handwerker	Helen Ondik
N. B. Belecki	Jonathan E. Hardis	Hans J. Oser
Norman F. Berk	Allan H. Harvey	Albert C. Parr
Barry Bernstein	Jim L. Heldenbrand	H. Steffen Peiser
Stanley Block	D. A. Hill	Daniel T. Pierce
Ronald F. Boisvert	James E. Hill	Gaspar Piermarini
Lewis M. Branscomb	John Hoffman	Michael T. Postek
Maureen Breitenberg	Ralph P. Hudson	James E. Potzick
Carroll Brickencamp	A-M. Jeffrey	Thomas M. Proctor
E. A. Brown	Vicky Lynn Karen	Stanley Rasberry
Richard Bukowski	Takashi Kashiwagi	Curt Reimann
William E. Burr	Elliot Kearsley	A. G. Repjar
John Cahn	Sharon J. Kemmerer	Ralph A. Richter
Robert J. Celotta	Freddy Khoury	Steven Rolston
Geraldine Cheok	J. R. Kinard, Jr.	John R. Rumble, Jr.
Charles W. Clark	Russell A. Kirsch	Harry A. Schafft
Sam Coriell	Ralph Klein	F. Scire
Bert Coursey	Joan Koenig	Thomas R. Scott
M. Carroll Croarkin	Richard H. Kropschot	Robert Sienkiewicz
John Cugini	Robert D. Larrabee	Tom Siewert
Tom Davis	James Lawrence	Deborah Smyth
Richard D. Deslattes	Walter G. Leight	Richard N. Spivack
Ted Doiron	Tom Lettieri	Kenneth D. Steckler
R. Dziuba	Johanna M. H. Levelt Sengers	Donald B. Sullivan
Charles Ehrlich	Don Libes	Y. Tang
J. W. Ekin	David R. Lide	E. C. Teague
Bruce R. Ellingwood	Richard M. Lindstrom	John Tesk
R. E. Elmquist	Daniel W. Lozier	W. R. Thurber
David Evans	William Luecke	W. Reeves Tilley
James Faller	John W. Lyons	Terrell Vanderah
Fred Fickett	Ted Madey	J. S. Villarrubia
B. Fonoroff	J. F. Mayo-Wells	George Walton
D. L. Franzen	Calvin S. McCamy	Wolfgang L. Wiese
Stephen Freiman	Howard McMurdie	E. R. Williams
Geoffrey Frohnsdorff	James R. McNesby	William K. Wilson
Edwin Fuller	Norman E. Mease	Christoph Witzgall
J. W. Gadzuk	Alan D. Mighell	Richard Wright
Ernest Garner	Michael R. Moldover	John Yates
Saul Gass	Raymond D. Mountain	R. D. Young
Frank Gayle	Ronald Munro	Robert R. Zarr
Thomas E. Gills	Victor Nedzelnitsky	Joel P. Zingesser
Alan Goldman	Harold Nelson	
Martha M. Gray	Dale E. Newbury	

Other Acknowledgments

In addition to the individuals listed above, several others have played a key role in the preparation of this volume. Particular thanks are due to Susan Makar for meticulous checking of the bibliographic references; to Ilse Putman for an excellent typesetting job; to Carolyn Stull for carefully editing the final manuscripts; and to Kristy Thompson for designing and maintaining the web site for the Centennial Publications project.

Table of Contents

Introduction	1
1901-1930	
The Absolute Measurement of Inductance	5
Determination of the Constants of Total Radiation From a Black Body	7
The Testing of Thermal Insulators	10
Precipitation Hardening of Metal Alloys	14
Construction and Operation of a Simple Homemade Radio Receiving Outfit	16
Methods for Standardizing and Testing Precision Gage Blocks	19
Recommended Minimum Requirements for Small Dwelling Construction	22
Visibility of Radiant Energy	25
Test of the Severity of Building Fires	28
Calculation of Compounds in Portland Cements	33
Development of the Visual-Type Airway Radio-Beacon System	38
1931-1950	
A Hydrogen Isotope of Mass 2	43
Air Flow and Turbulence in Boundary Layers	46
Thermodynamic Properties of Water and Steam for Power Generation	49
Absolute Pressure Calibrations of Microphones	53
Absolute Determination of the Ampere	56
Radio Proximity Fuzes	59
Stability of Double-Walled Manganin Resistors	63
Manufacture of Paper for War Maps and Other Applications	66
Transmission of Sound Waves in Gases at Low Pressures	69
Atomic Energy Levels and Other Spectroscopic Data	73
Iteration Method for the Solution of the Eigenvalue Problem of Linear Differential and Integral Operators ..	77
1951-1960	
Methods of Conjugate Gradients for Solving Linear Systems	81
Computer Development at the National Bureau of Standards	86
Thermal Converters as AC-DC Transfer Standards for Current and Voltage Measurements at Audio Frequencies	90
Selected Values of Chemical Thermodynamic Properties	93
Applied Inorganic Analysis	97
The Diamond Anvil Pressure Cell	100
Polymer Crystallization With Folded Chains	104
Cryogenic Engineering	107
Reversal of the Parity Conservation Law in Nuclear Physics	111
1961-1970	
Effects of Configuration Interaction on Intensities and Phase Shifts	116
Electromagnetic Waves in Stratified Media	120
“Second Breakdown” in Transistors	123
Stress Relaxation With Finite Strain	126
Realistic Evaluation of the Precision and Accuracy of Instrument Calibration Systems	129
Experimental Statistics	132
Handbook of Mathematical Functions	135

1961-1970 — Cont.

Paths, Trees, and Flowers	140
Concepts, Terminology, and Notation for Optical Modulation	145
Theory of Light Scattering in Fluids	149
Scaling Analysis of Thermodynamic Properties in the Critical Region of Fluids	152
Resonance Tunneling of Field Emitted Electrons Through Adsorbates on Metal Surfaces	155
Quantitative Electron Probe Microanalysis	160
Limits for Qualitative Detection and Quantitative Determination	164
Traceability: An Evolving Concept	167
Code for Information Interchange—ASCII	172
Consumer Information Series	174
Theory of Isoperibol Calorimetry for Laser Power and Energy Measurement	178
Influence of Water on Crack Growth in Glass	181
Phase Equilibria Diagrams	184
Determination of Reduced Cells in Crystallography	188

1971-1980

Speed of Light From Direct Frequency and Wavelength Measurements	191
Connecting Visible Wavelength Standards With X Rays and γ Rays	194
Laser Cooling of Atoms	200
Spin-Polarized Electrons	203
Needs for Radioactivity Standards and Measurements in Different Fields	209
The Topografiner: An Instrument for Measuring Surface Microtopography	214
Electron-Stimulated Desorption	219
Photochemistry of Small Molecules	224
Role of Standard Reference Materials in Measurement Systems	227
Metrology and Standardization to Assist Industrializing Economies	230
Publications Taking Us Toward a Metric America	234
A New Approach to Manipulator Control: The Cerebellar Model Articulation Controller	237
Three Dimensional Metrology	241
Initial Graphics Exchange Specifications	246
Data Encryption Standard	250
OMNIDATA and the Computerization of Scientific Data	254
FORTTRAN Test Programs	258
Design and Evaluation Criteria for Energy Conservation in New Buildings	260
Computer Program for Heating and Cooling Loads in Buildings	266
Methods for Testing and Rating the Performance of Heating and Air Conditioning Systems	270
System for Fire Safety Evaluation of Health Care Facilities	275
Estimation of Rate of Heat Release by Means of Oxygen Consumption Measurements	280
Probability-Based Load Criteria for Structural Design	283
Resistivity-Dopant Density Relationship for Phosphorus-Doped Silicon	289

1981-1990

Critical Data for Critical Needs	291
Materials at Low Temperatures	294
Optical Fiber Characterization	297
Quasicrystals	300
Protein Crystallography by Joint X-Ray and Neutron Diffraction	303
Strain Effects in Superconducting Compounds	306
Dental Research at the National Bureau of Standards	309
Handbook for Standard Reference Materials Users	313
A Practical Josephson Voltage Standard at One Volt	315
Plane-Wave Scattering-Matrix Theory of Antennas and Antenna-Antenna Interactions	319
The Automated Manufacturing Research Facility	322

1981-1990 — Cont.

Submicrometer Linewidth Metrology	328
Observation of Atoms Laser-Cooled Below the Doppler Limit.	331
Laser-Excited Hot-Electron Induced Desorption.	334
Measurement of the Universal Gas Constant Using an Acoustic Resonator.	339
Thermal and Oxidative Degradation of Polymers.	344
HAZARD I: Software for Fire Hazard Assessment.	347
Analysis of the Catastrophic Rupture of a Pressure Vessel.	350
Curing Those Uncontrollable Fits of Interaction	353
Baldrige Criteria for Performance Excellence.	357

1991-2000

The Advanced Technology Program	359
NIST Manufacturing Extension Partnership	363
Questions and Answers on Quality	366
Uniformity in Weights and Measures Laws and Regulations	368
Certification of 10 μm Diameter Polystyrene Spheres (“Space Beads”).	371
Bose-Einstein Condensation in a Dilute Atomic Vapor	375

Index.	379
-------------------------	-----

Introduction

The National Bureau of Standards was established by Congress on March 3, 1901, with a charge to take custody of the standards of physical measurement in the United States and to solve “problems which arise in connection with standards.” Although minor (and transient) variations occurred in the name of the institution, it was known for most of the century as NBS until Congress mandated a major name change, accompanied by new responsibilities, in 1988. Thus the “Bureau” completed its first century as the National Institute of Standards and Technology, or NIST. This volume commemorates the centennial by presenting brief accounts of selected classic publications of NBS/NIST which illustrate at the same time the rich history of its scientific and technical accomplishments and the broad scope of its contributions to the Nation.

If asked to select one word that best describes the work of the institution, most people familiar with NBS/NIST would choose “measurement.” Indeed, the theme of precise, accurate measurements runs through the first century’s history. Seventeen years before the founding of NBS, Lord Kelvin wrote [1],

“When you can measure what you are speaking about, and express it in numbers, you know something about it; but when you cannot measure it, when you cannot express it in numbers, your knowledge is of a meager and unsatisfactory kind: it may be the beginning of knowledge, but you have scarcely, in your thoughts, advanced to the stage of science.”

His statement captures very elegantly the philosophy and culture of NBS/NIST. The measurement methodology described in this volume runs the gamut from cutting-edge research in atomic physics to new ways of measuring the heat released in building fires; from measuring the response of the human eye to different colors to selecting the best sets of data for improving rocket engine performance; and from automating manufacturing processes to advising consumers on how to buy tires for their cars. These publications illustrate the support NBS/NIST has given to U.S. industry and to other Federal agencies in solving specific measurement problems, as well as the impact of Bureau work on the scientific community at large and on the general public.

With so many diverse audiences to serve, communication of the results of its work has been a major concern since the founding of NBS. In a remarkably prescient article published in *Science* in 1905, Edward B. Rosa, one of the 11 initial NBS staff members (the only one with the title of “Physicist”) outlined his vision of the future of the Bureau [2]. In addition to its mission to maintain the standards of measure of the United States and to advance the art of precise measurements, he added a third mandate, “To distribute information regarding instruments and standards to manufacturers, state and city sealers of weights and measures, scientific and technical laboratories, and to any and every one applying for such information”—a daunting challenge which the Bureau has taken very seriously. Rosa went on to stress the interdependence of the three functions and to explain that the distribution of information would be “accomplished through correspondence and the circulars and bulletins issued by the bureau,” thereby setting the stage for the broad publication program illustrated in this book.

There are, of course, other mechanisms by which the Bureau has disseminated its information. Staff members have described their work through lectures at academic and industrial establishments and to foreign audiences. Participation in national and international standards committees has been a very significant transfer mechanism. Thousands of guest workers from industry, academia, and other national laboratories have spent time working in Bureau laboratories, taking new technology and new ideas back to their home institutions (as envisioned by Rosa in his 1905 article). Unique facilities—the research reactor, synchrotron radiation source, and automated manufacturing research facility, to name only a few—have drawn scientists and engineers to NBS/NIST where they could carry out measurements that would be difficult or impossible elsewhere. Nevertheless, formal publications have arguably been the most influential single mechanism for the institution to reach its diverse audience over the century. It is the intention of this book to give the flavor of those publications.

The book consists of short accounts describing 102 representative publications that had a significant impact during NBS/NIST's first century. These 102 were chosen, out of tens of thousands that have appeared in print, to illustrate the range of activities covered by the publication program. Many others are equally deserving of mention and, in fact, some of these are listed in the bibliographies accompanying each account. The final selection was made by a committee of representatives of the major units in the current NIST organizational structure plus the Standards Alumni Association, which looked especially at candidate publications from the early days of NBS. This committee considered over 400 nominations from NIST staff and alumni in arriving at the final 102. An effort was made to cover the most significant NIST/NBS programs, including those in which formal publications are not the dominant communication mechanism.

The selected publications are arranged in the book by time periods. Those from the first half of the century are grouped into two periods, 1901-1930 and 1931-1950. The publications from the second half are listed by decade. Within each decade certain papers on related topics have been grouped together. An index of subjects and individuals appears at the end.

Certain important works were not considered for this book, even though they had significant input from staff members, because they were not, strictly speaking, NBS/NIST publications. Among these is the *International Critical Tables* [3], a seven-volume series prepared in the 1920s whose contributors included hundreds of scientists from all parts of the world, in addition to many NBS staff members. The Editor-in-Chief was E. W. Washburn, Chief of the NBS Chemistry Division, and the Editorial Board included G. K. Burgess, Director of NBS. The preface, written on behalf of the National Research Council (the official publisher), gives special acknowledgment to NBS for its leadership. The *International Critical Tables* was the definitive source for accurate data for the next 30 to 40 years, used at every level of science and technology, from undergraduate teaching to engineering design. It remained in print until about 1980, and it is still found (and still used as a reference) in every major library of the physical and engineering sciences. Also in this category are countless standards documents in which NBS/NIST staff played a major role but which were published by ASTM, ANSI, ASHRAE, and other national standards organizations as well as by international groups such as ISO, CODATA, IUPAC, and the various committees of the International Bureau of Weights and Measures (BIPM). Such documents tend to be anonymous in the sense of bibliographic citations, but Bureau representatives are frequently among the prime movers in the committees that prepare them. As a particular example, NBS/NIST has made strong input to the Consultative Committee on Units (CCU), the group responsible for promulgation of the International System of Units (SI), the "modern metric system" [4]. Special mention should also be given to the Fundamental Physical Constants, a continuing project in which Barry N. Taylor and other NIST physicists have played the dominant role over the last quarter of the century. Their set of *CODATA Recommended Values of the Fundamental Physical Constants* [5] has been universally adopted for worldwide use.

For those interested in the full history of NIST, several publications are available. The 1905 paper by Rosa [2], which summarizes the work during the first few years, has already been mentioned. Three official histories have been written. *Measures for Progress*, by Rexmond Cochrane, covers the first 50 years [6]. Elio Passaglia's *A Unique Institution* follows with coverage of the 1950-1969 period [7]. James Schooley rounded out the history of the first century with *Responding to National Needs: The National Bureau of Standards Becomes the National Institute of Standards and Technology (1969-1993)* [8]. These books give extensive administrative, financial, and personnel details, as well as summaries of the technical work during each period.

The contributions of NBS during the two world wars, which could not be published at the time the work was done, is very well documented in two reports which make fascinating reading. The book *War Work of the Bureau of Standards* [9] describes about 200 projects undertaken during World War I; these range from studies of shoe leather and metal for military identification tags to utilization of the Bureau's expertise in spectroscopy to improve methods of aerial photography. Bureau metallurgists were particularly active in helping the military develop specifications and testing methods for items ranging from armor plate and steel helmets to horseshoe nails. The story for the second world war is given in *NBS War Research. The National Bureau of Standards in World War II* [10], edited by former Director Lyman J. Briggs. While the best known NBS contribution was the proximity fuze (described in more detail in one of the accounts in this book), almost every part of the organization became involved in war work of some kind. Director Briggs was appointed by President Roosevelt in 1939 as chairman of the first committee to investigate the feasibility of

building an atomic bomb; ultimately, about 60 NBS staff members worked on the bomb project. NBS made a major contribution in developing methods to purify uranium and graphite, which was used as a moderator in the reactors that produced plutonium, and the first experiments on separating uranium isotopes by thermal diffusion were done in a Bureau laboratory.

The publications described in this book appeared in a variety of media, which is characteristic of NBS/NIST publications as a whole. Many appeared in scholarly journals of scientific and engineering societies; a few came out as books through commercial publishers. The rest appeared in one or another of the Bureau's own publication series. It may be useful to describe these briefly. The *Journal of Research of the National Institute of Standards and Technology*, which traces its origin to 1928, publishes research papers by staff members in all fields covered by NIST. Larger works of long term-interest have appeared in the *Monograph* and *Handbook* series, and the *Special Publication* series is available for works that do not conveniently fit into other categories. Interim or transient reports appear as *Technical Notes* or *NISTIRs* (where "I" can mean either Internal or Interagency). Some NIST programs have their own series, e.g., the *Building Science Series*, the *National Standard Reference Data Series* (NSRDS-NBS), the *Applied Mathematics Series* (AMS), and the *Federal Information Processing Standards* (FIPS). The Bureau has also joined outside organizations in certain publication series, for example, the *Journal of Physical and Chemical Reference Data*, started in 1972 as a joint endeavor of NBS, the American Institute of Physics, and the American Chemical Society. This journal has published almost 600 critically evaluated data compilations, submitted both by NIST scientists and outside authors, as well as 21 supplementary hard-cover monographs.

The classic documents described in this book are traditional publications on paper. The last decade of NBS/NIST's first century saw the start of a major revolution in communications with the emergence of electronic publishing. NIST scientists are already making heavy use of this medium, and the bibliographies in this book show many references to Internet sites. A number of NIST Laboratories and Programs have established World Wide Web sites which receive heavy use by the scientific community. This form of publication is developing too fast to give a comprehensive list of sites, but the following examples convey the flavor of NIST's current efforts:

- Physical Reference Data <<http://physics.nist.gov/PhysRefData/>>—fundamental constants, atomic and molecular spectra, x-ray attenuation, and radiation dosimetry data.
- Chemistry WebBook <<http://webbook.nist.gov>>—evaluated data on thermal properties and spectra of thousands of chemical compounds, including the heavily used NIST/EPA/NIH Mass Spectral Library.
- Digital Library of Mathematical Functions <<http://dlmf.nist.gov>>—under development as a modern version of the 1964 classic *Handbook of Mathematical Functions*.
- Fire Research Information Services <<http://fris.nist.gov>>—provides access to fire test data, publications, and fire modeling programs.
- MSEL Data on the Web <<http://www.msel.nist.gov/dataontheweb.html>>—mechanical, thermal, and chemical properties of ceramics, metals, and polymers.
- Protein Data Bank <<http://nist.rcsb.org/pdb>>—3-D crystal structure of proteins.

These and other NIST web sites are already accessed thousands of times each day, and use of the sites is growing rapidly. As it enters its second century, we can expect the National Institute of Standards and Technology to take full advantage of the new opportunities for disseminating the results of its work.

David R. Lide

Bibliography

- [1] Sir William Thomson (Lord Kelvin), Lecture to the Institution of Civil Engineers (May 3, 1883), in *Popular Lectures and Addresses* Vol. 1, p. 80, Macmillan and Co., London & New York, (1891).
- [2] Edward B. Rosa, The National Bureau of Standards and its Relation to Scientific and Technical Laboratories, *Science* **21**, 161-174 (1905).
- [3] Edward W. Washburn (ed.), *International Critical Tables of Numerical Data of Physics, Chemistry, and Technology*; published for National Research Council by McGraw-Hill Book Company, New York (1926/1932).

- [4] *Le Système International d'Unités (SI), 5^e Édition*, Bureau International des Poids et Mesures, Sevres, France (1985) [includes English translation]; see also Barry N. Taylor, *Guide for the Use of the International System of Units (SI)*, NIST Special Publication 811, National Institute of Standards and Technology, Gaithersburg, MD (1995).
- [5] Peter J. Mohr and Barry N. Taylor, CODATA Recommended Values of the Fundamental Physical Constants: 1998, *J. Phys. Chem. Ref. Data* **28**, 1713-1852 (1999).
- [6] Rexmond C. Cochrane, *Measures for Progress. A History of the National Bureau of Standards*, NBS Special Publication 275, U.S. Government Printing Office, Washington, DC (1966).
- [7] Elio Passaglia, *A Unique Institution. The National Bureau of Standards, 1950-1969*, NIST Special Publication 925, U.S. Government Printing Office, Washington, DC (1999).
- [8] James Schooley, *Responding to National Needs: The National Bureau of Standards Becomes the National Institute of Standards and Technology (1969-1993)*, NIST Special Publication 955, U.S. Government Printing Office, Washington, DC (2000).
- [9] *War Work of the Bureau of Standards*, Miscellaneous Publications of the Bureau of Standards, No. 46, U.S. Government Printing Office, Washington, DC (1921).
- [10] Lyman J. Briggs (ed.), *NBS War Research. The National Bureau of Standards in World War II*, U.S. Department of Commerce (1949).

The Absolute Measurement of Inductance

This paper [1] represents the first Bureau of Standards scientific contribution of Edward B. Rosa, Chief Physicist and first Division Chief (Electricity Division) of NBS. Rosa was an outstanding and prolific physicist and writer, having provided the basis for the century-long international pre-eminence of NBS/NIST in electrical metrology. He authored or co-authored some 75 NBS papers ranging in topic from fundamental electrical measurements through practical papers on electromagnetic calculations and applied measurement techniques to descriptions of basic work in electrolysis and photometrics. As an example of his breadth of interest, Rosa invented an ingenious respiration calorimeter with Wilbur O. Atwater that was to prove highly useful in subsequent pioneer investigations of food values and problems of nutrition in this country. Towards the end of his career he carried out an exhaustive study of government research and its relation to the federal budget, which had an influence on the establishment of the Bureau of the Budget, the predecessor of the present Office of Management and Budget. His name is pronounced “Ro-zay,” with emphasis on the second syllable.

The first Director of the Bureau, Samuel Wesley Stratton, found that the most urgent task of this new appointment was to find an outstanding individual to plan and direct the electrical research program that had dominated the arguments for the creation of the Bureau. His attention was drawn to Edward Bennett Rosa. Rosa (1861-1921), of Dutch ancestry, had taught physics and chemistry after getting his B.S. degree at Wesleyan University in Connecticut and then entered the Johns Hopkins University as a graduate student in physics under Henry A. Rowland. Receiving his doctorate in 1891, he returned to Wesleyan as associate professor of physics, becoming full professor the next year. Stratton hired him as a physicist at \$3,500, and a decade later, with his electrical group firmly established as the premier division of the Bureau, he was made chief physicist.

The paper [1] reflects an early commitment to outstanding work in the electrical metrology field by a fledgling organization. This was in response to overwhelming needs in U.S. industry for a single, consistent basis for measurements of power, current, impedance, and voltage to support the electrical power industry, the transition of manufacturing from mechanical to electrical power, and the burgeoning electrical instruments

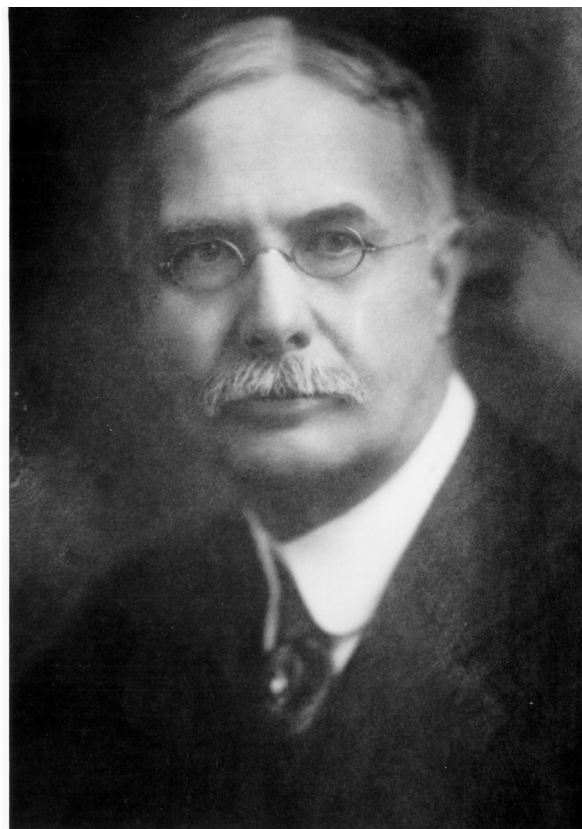

Fig. 1. Edward B. Rosa, who set the pace for the high level of research at the Bureau in its first two decades. Rosa probably sat for this portrait about 1915, but according to Francis Silsbee, who knew him, it could have been made at almost any time, for Rosa did not change much in all his years at the Bureau.

industry, as well as the growing position of the U.S. in world trade and science.

At the 1908 International Conference on Electrical Units and Standards in London, it was recommended that representatives of the National Measurement Institutes (i.e., counterparts to NBS/NIST) should meet and agree on new values of international units as defined by the mercury ohm and silver voltameter. In April and May 1910, the International Technical Committee met in Washington at NBS. Scientists from Germany, France, and Great Britain brought standard resistors and standard cells that had been carefully evaluated in terms of their national units. As Chief of the Electricity Division, Rosa headed this committee. Comparisons made at the meeting showed that the

resistance unit represented by the German standards was only 1×10^{-5} larger than that of the British. Results of work then in progress under Rosa were in reasonable agreement, and the committee recommended that all countries use, as the international ohm, the mean of the values found by Germany and Great Britain [2,3].

The present NIST impedance calibration laboratory (ICL) promotes the use of the SI units farad and henry through capacitance and inductance calibrations for customers, both inside and outside NIST. The ICL provides calibrations of nominal-valued capacitors in the range from 0.001 pF to 1 μ F in the frequency range from 100 Hz to 10 kHz. Customers include aerospace companies, instrumentation companies, the U.S. armed forces, secondary calibration laboratories, and other U.S. and foreign national laboratories. The ICL also provides capacitance calibrations at 1 kHz that are used by the high-frequency calibration laboratories at NIST for their calibrations at frequencies above 1 MHz.

The SI impedance unit, the henry, is obtained from the capacitance and resistance units, the farad and ohm. The ICL provides calibrations of inductors in the range 50 mHz to 10 Hz in the frequency range from 65 Hz to 10 kHz. The inductance value is found using the

Maxwell-Wien bridge [4], which derives the value of the inductor by comparison against two resistors and a capacitor.

Prepared by A-M. Jeffery, N. B. Belecki, and J. F. Mayo-Wells, based on The Ampere and Electrical Units [5], authored by members of the Electricity Division.

Bibliography

- [1] Edward B. Rosa and Frederick W. Grover, The Absolute Measurement of Inductance, *Bull. Bur. Stand.* **1**, 125-152 (1905).
- [2] F. B. Silsbee, *Establishment and maintenance of the electrical units*, NBS Circular 475, National Bureau of Standards, Washington, DC (1949).
- [3] *Report to the International Committee on Electrical Units and Standards*, NBS Miscellaneous Publications 16, National Bureau of Standards, Washington, DC (1912).
- [4] Thomas L. Zapf, Calibration of inductance standards in the Maxwell-Wien bridge circuit, *J. Res. Natl. Bur. Stand.* **65C**, 183-188 (1961).
- [5] R. E. Elmquist, M. E. Cage, Y-H. Tang, A-M. Jeffery, J. R. Kinard, R. F. Dziuba, N. M. Oldham, and E. R. Williams, The Ampere and Electrical Units, *J. Res. Natl. Inst. Stand. Technol.*, January-February (2001).

Determination of the Constants of Total Radiation From a Black Body

This paper [1] presents a critical review of the state of knowledge about the constant of nature that relates the quantity of radiant heat and light to the temperature of the radiant object. Studies of this issue at the beginning of the 20th century ultimately led to the discovery of quantum mechanics, the keystone of modern physics. The continuity of this work at NIST for the remainder of the century also led to fundamental changes in the way that optical metrology is now carried out.

In 1905 Samuel W. Stratton, the Director of the National Bureau of Standards, persuaded a young research associate at the Washington Carnegie Institute to come to the NBS laboratories to undertake research programs in infrared spectroscopy. Thus William Weber Coblentz began a nearly 40-year career at NBS that resulted in over 400 publications in diverse areas of optical research. Stratton's original intent was to use Coblentz as an assistant in his own laboratory, but these demands were modest and Coblentz was able to pursue his own interests in infrared spectroscopy and radiometry, begun as a graduate student at Cornell. One of the suggestions offered by Stratton led to the work cited here and to the establishment of the science of radiometry at NBS.

The first decade of the 20th century was a very important time in the development of concepts in modern physics. One of the of the great mysteries of the era was the underlying principle behind blackbody radiation, the heat and light emitted from hot objects. (Black objects are studied in order to eliminate the effect of reflection.) Max Planck in Germany had developed a theory that appeared to explain the phenomenon in proper detail, but it required the introduction of a revolutionary new idea. In Planck's theory, the energy of light and other electromagnetic radiation was quantized in discrete increments. The proportionality between the energy increment and the frequency of the radiation became known as Planck's constant.

The spectral distribution of blackbody radiation, that is, its radiance at different wavelengths, is determined by its temperature. Early on, the quantitative details were described by presuming two constants of nature, which became known as the first and second radiation constants. Additionally, the total energy of the radiation emitted was shown to be proportional to the fourth power of the temperature. This proportionality constant was named the Stefan-Boltzmann constant after the theoretical physicists who first calculated the relationship.

The Stefan-Boltzmann constant can be expressed in terms of the other radiation constants or the fundamental constants now known as Planck's constant, the Boltzmann constant, and the speed of light. This process of unifying basic phenomena and verifying the ideas with accurate experiments was central to the development of physics at the turn of the century.

On a visit to Europe, Stratton observed that a number of the national laboratories in Europe were expending considerable effort in measuring the radiation constants for describing the spectral distribution and total radiation from blackbody sources. Stratton suggested to Coblentz that it would be good if NBS could contribute to this effort and recommended that Coblentz direct his efforts in this regard.

The accuracy that Coblentz was able to achieve with his early instruments is a testimony to his diligence, rare experimental insight, and scientific capability.

During 1914–16, Coblentz developed an absolute radiometer, measured the Stefan-Boltzmann constant, and reported the results in the review article [1]. To perform this measurement he constructed a thermopile-based electrically calibrated radiometer to measure the total power from a blackbody radiator [2]. The temperature of the blackbody varied between 1000 K and 1400 K, and hence most of the radiation was in the infrared region of the spectrum. Based upon designs by Ångström and others, Coblentz designed a radiometer incorporating an electrical heater so that the optical power could be measured by comparing it to an equivalent amount of electrical power, each causing the radiometer to rise to the same temperature. A thermopile consists of an array of thermocouple junctions that are connected in series and parallel to produce a changing voltage as their temperature changes. Coblentz experimented with various arrangements of joining the thermocouple junctions in order to improve their sensitivity and response time. He was able to achieve a sensitivity of about 10 nW [3].

Using these thermopile detectors, Coblenz was able to measure the radiation constants to within 0.5 % of their presently accepted values. His result for the Stefan-Boltzmann constant was within 1 % of its present value, and he was able to calculate a value for Planck's constant that differed from the modern value by only 0.8 %. His results were among the best in the world at that time, and additionally, he was able to show that the shape of the blackbody spectrum, its intensity as a function of wavelength, agreed with Planck's theory.

In carrying out these difficult measurements he used the expertise he gained in graduate school while making infrared measurements of the absorption spectrum of various gases and materials. He knew how to account correctly for the effects of atmospheric water and carbon dioxide, as well as impurities that could cause anomalous absorption. He designed and built both absolute and relative detectors, and he constructed monochromators appropriate to the task of performing the spectral measurements of blackbody radiators. The manufacture of these devices required exquisite and detailed work, with small receivers and intricate wiring of the thermopiles.

Coblenz is considered the originator of molecular infrared spectroscopy in the United States, and a society named after him, the Coblenz Society, arranges scientific meetings and other activities for specialists interested in the infrared region of the spectrum for a variety of analytical and other purposes [4]. His body of spectroscopic work during his career at NBS is too extensive to review here—in these and other fields, he published more than 400 papers in leading scientific journals.

Coblenz also had a life-long interest in astronomy. He actively participated in astronomical observations until his retirement in 1945, and he contributed significantly to the art of stellar observations by developing sensitive radiometers that could be used for stellar photometry [5]. These were used in many observatories throughout the United States.

Coblenz applied his technology to the early NBS efforts in human visual photometry and developed an early experiment to determine the so-called mechanical equivalent of light. To do this he measured the visual wavelength response of a number of observers and then calculated the radiant luminous efficiency of a blackbody source at known temperatures [6,7]. His early work in photometry, including work on standard sources and human visual response, helped set the stage for the work of Tyndall and Gibson that resulted in the modern system of photometry used throughout the world. The photometric units of luminous flux and luminous intensity were maintained by the world's national laboratories using candles, gas flames, and incandescent lamps until the candela was defined in

1979 by the CIPM in terms of optical power. The work Coblenz performed in the Stefan-Boltzmann and other blackbody studies was the progenitor of the detector development used in the visual photometry efforts.

In the late 1960s, scientists sought a more precise value of the Stefan-Boltzmann constant by utilizing new technology. Blevin and Brown at the CSIRO in Australia developed a more precise experiment and measured the total radiation at the gold melting point to obtain a value within 0.1 % of that calculated from the fundamental constants [8]. At NBS, Ginnings and Reilly built a new version of the classic Coblenz experiment, but with a modern innovation—their electrical-substitution radiometer operated at liquid-helium temperature in order to gain sensitivity and reduce noise [9]. For a variety of reasons, including the difficulty in correcting for diffraction and scattering effects, Ginning and Reilly did not achieve the accuracy they desired. However, in the attempt they developed a new type of radiometer, the cryogenic radiometer, that has ignited a modern revolution in radiometric accuracy.

Using ideas from the Ginnings and Reilly work, Quinn and Martin at the National Physical Laboratory (NPL) in the United Kingdom developed a new cryogenic instrument and succeeded in measuring the Stefan-Boltzmann constant to within 0.02 % of the value calculated from the fundamental constants [10]. This landmark work by Quinn and Martin, and further work by the NPL team, provided a basis for establishing the cryogenic radiometer as the fundamental high-accuracy instrument for all radiometric standards work [11]. NIST's work in cryogenic radiometry was continued by Yokley, who built a very highly sensitive cryogenic radiometer for calibrating very low level, low temperature thermal sources [12].

The cryogenic radiometer and its inherent accuracy of 0.05 % or better has revolutionized optical and photometric measurements. No longer do we think in terms of primary, standard sources of light. Instead, the best standards work is based upon measurements and comparisons of detectors of light [13, 14]. The 1979 redefinition of the candela in terms of optical power takes full advantage of cryogenic radiometry to put modern photometric standards on a detector basis [15]. Cryogenic radiometry, together with new technology in silicon photodiodes, low-noise amplifiers, and precision optical filters, has spawned new types of standards for the candela, lumen, and lux. Further developments have placed the spectral radiance and irradiance scales on an absolute detector base through the accurate measurement of the temperatures of blackbody sources with narrow-band filtered photodetectors. All of these will continue to improve over time as further improvements to filters and the detectors are anticipated.

The fundamental strategy originated at NBS by Coblenz in making radiometric and photometric measurements with electrically calibrated optical detectors set the stage at NIST for the present-day and future standards work. The continued importance of better measuring the Stefan-Boltzmann constant spurred the development of the modern cryogenic radiometer, which is found today in most national standards laboratories throughout the world. The legacy of Coblenz's work in the early 20th century to develop even more sensitive optical detectors is a continuing effort to keep pace with such needs. The accuracy that Coblenz was able to achieve with his early instruments is a testimony to his diligence, rare experimental insight, and scientific capability. His work is the cornerstone of radiometry, photometry, and infrared spectroscopy at NIST.

Prepared by Albert C. Parr.

Bibliography

- [1] W. W. Coblenz, Present status of the determination of the constant of total radiation from a black body, *Bull. Bur. Stand.* **12**, 553-582 (1916).
- [2] W. W. Coblenz and W. B. Emerson, Studies of instruments for measuring radiant energy in absolute value; an absolute thermopile, *Bull. Bur. Stand.* **12**, 503-551 (1916).
- [3] W. W. Coblenz, Various modifications of bismuth-silver thermopiles having a continuous absorbing surface, *Bull. Bur. Stand.* **11**, 131-187 (1914).
- [4] Coblenz Society, 761 Main Street, Norwalk, CT 06859-0002; (<http://www.galactic.com/Coblenz/Index.htm>)
- [5] W. W. Coblenz, A comparison of stellar radiometers and radiometric measurements on 110 stars, *Bull. Bur. Stand.* **11**, 613-656 (1915).
- [6] W. W. Coblenz and W. B. Emerson, Relative sensibility of the average eye to light of different colors and some practical applications to radiation problems, *Bull. Bur. Stand.* **14**, 167-236 (1918).
- [7] W. W. Coblenz and W. B. Emerson, Luminous radiation from a black body and the mechanical equivalent of light, *Bull. Bur. Stand.* **14**, 255-266 (1918).
- [8] W. R. Blevin and W. J. Brown, A precise measurement of the Stefan-Boltzmann constant, *Metrologia* **7**, 15-29 (1971).
- [9] D. C. Ginnings and M. L. Reilly, Calorimetric measurement of thermodynamic temperatures above 0 °C using total blackbody radiation, in *Temperature; Its Measurement and Control in Science and Industry, Vol. 4*, Instrument Society of America, Pittsburgh (1972), pp. 339-348.
- [10] T. J. Quinn and J. E. Martin, A radiometric determination of the Stefan-Boltzmann constant and thermodynamic temperatures between -40 °C and +100 °C, *Philos. Trans. R. Soc. London* **A316**, 85-189 (1985).
- [11] J. E. Martin, N. P. Fox, and P. J. Key, A cryogenic radiometer for absolute radiometric measurements, *Metrologia* **21**, 147-155 (1985).
- [12] C. R. Yokley, *A radiometric calibration facility for low temperature blackbodies*, Final Report to the NASA Lyndon B. Johnson Space Center, contract T-955C, November 23, 1976.
- [13] A. C. Parr, *A National Measurement System for Radiometry, Photometry, and Pyrometry Based Upon Absolute Detectors*, NIST Technical Note 1421, National Institute of Standards and Technology, Gaithersburg, MD (1996).
- [14] T. R. Gentile, J. M. Houston, J. E. Hardis, C. L. Cromer, and A. C. Parr, National Institute of Standards and Technology high-accuracy cryogenic radiometer, *Appl. Opt.* **35**, 1056-1068 (1996).
- [15] C. L. Cromer, G. Eppeldauer, J. E. Hardis, T. C. Larason, Y. Ohno, and A. C. Parr, The NIST Detector-Based Luminous Intensity Scale, *J. Res. Natl. Inst. Stand. Technol.* **101**, 109-132 (1996).

The Testing of Thermal Insulators

At the turn of the 20th century the refrigeration industry in the United States was becoming a commercial reality. Mechanical refrigeration technology had achieved economic viability as a means of producing ice for cooling and was on the threshold of moving into households as an everyday appliance. Advances were underway to provide mechanical “air conditioning” for public buildings, such as theaters, department stores, and skyscrapers. In general, the early 1900s saw the evolution of a scientific approach to refrigeration through company-sponsored research and development. It was the technical progress in the area of cooling and heating for industrial processes and thermal comfort that stimulated the development of thermal insulation standards at NIST.

As described in *Measures for Progress: A History of the National Bureau of Standards*, Congress, at the request of the refrigeration industry, appropriated funding in 1913 for investigation of physical constants involved in the construction and operation of large-scale refrigeration machinery. Under Hobart C. Dickinson, D. R. Harper 3rd, and N. S. Osbourne, studies were conducted that included the investigation of insulating materials used in the construction of large-scale refrigeration structures. Of particular interest to the mechanical engineer was the development of usable data pertaining to heat transmission in thermal insulation needed for design purposes. For this purpose, Dickinson is credited with independently developing an absolute method of measurement called the guarded hot plate for homogenous slab-like materials.

In 1916, Dickinson and fellow NBS colleague Milton S. Van Dusen published *The Testing of Thermal Insulators* [1], a classic description of an NBS study to identify the causes of discordant experimental results for heat transfer through homogeneous solid materials and engineering systems. The publication contained accurate determinations of heat flow through air spaces and through 30 insulating materials; it also promoted the usage of standard terminology for thermal conductivity measurements obtained for solid materials and compound walls. Shortly after their first publication, Van Dusen published *The Thermal Conductivity of Heat Insulators* [2], which provided detailed information on the design and theory of operation of the apparatus, as well as additional thermal conductivity measurements of insulating materials. Important and insightful publications in their day, these papers are still considered

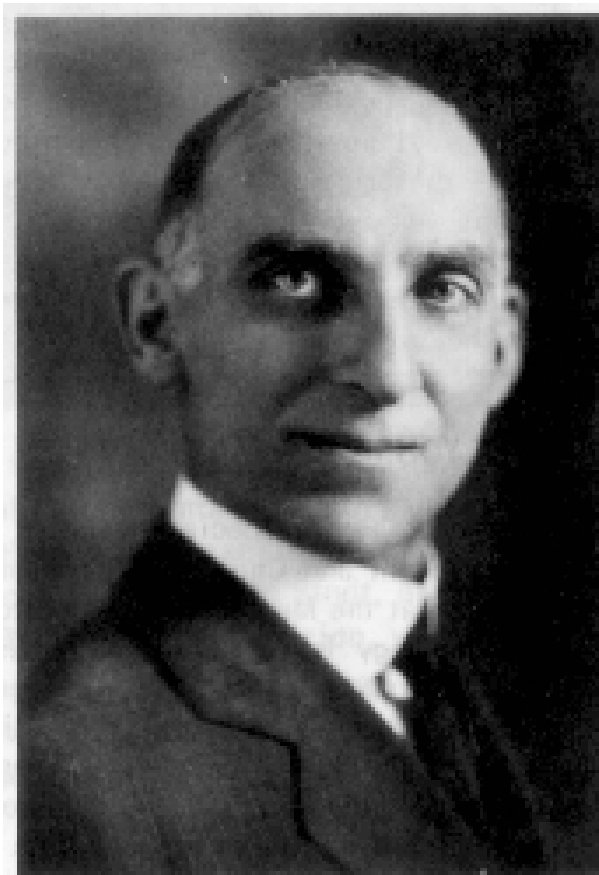

Fig. 1. Hobart C. Dickinson (1875-1949). While traveling in Europe, Dickinson learned that Richard Poensgen in Germany had independently developed and been using a guarded hot plate for thermal conductivity measurements since 1910. Thus, Poensgen is generally credited as the first to develop the guarded hot plate method.

recommended reading for all students of heat transfer through thermal insulation.

At NBS the guarded hot plate quickly became the foundation for thermal conductivity measurements of heat insulators, and this encouraged the development of other apparatus for the measurement of thermal conductivity of solids, not only for building materials but also for metals, refractories, and ceramics. In fact, one might argue that either directly or indirectly the apparatus has motivated nearly eight decades of thermal conductivity work on solids at NBS/NIST. An early spin-off was the development of the guarded hot box, which was based on similar principles of operation and was utilized for heat transmission measurements of simple and

compound walls. From 1915 to 1934, Van Dusen and others developed a comparative apparatus for measuring the thermal conductivity of metals up to 600 °C. Late in his career, in 1948, Dickinson developed a relatively simple steady-state method for thermal conductivity measurements of refractory solids. The apparatus employed a steam calorimeter for measuring the thermal conductivity of refractory solids from 400 °C to 1500 °C [3].

The long-term impact of the guarded hot plate technology was evident in several areas outside NBS. One of the first was the outgrowth of consensus engineering design data. The guarded hot plate originally developed by Dickinson and Van Dusen was refined over several years, and about 1928 Van Dusen [4] constructed a version of the apparatus that operated consistently until 1983. The thermal conductivity data obtained from this apparatus, along with the data from the early NBS publications [1,2], were aggregated with other data and tabulated in handbooks as design heat transmission coefficients for the engineer. These design data have served the engineering community effectively for several decades. In recent years, most of the original NBS data has been compiled in electronic format and will be available in NIST Standard Reference Database 81, *Heat Transmission Properties of Insulating and Building Materials* (Web Version 1.0).

However, the single most important impact of the guarded hot plate technology was the standardization of the test method in North America. This remarkable step has been extremely effective in reducing the differences among laboratories with respect to thermal testing. After many years of effort, NBS researcher Henry E. Robinson and others produced a tentative edition of the test method in 1942. By joint action, the American Society of Heating and Ventilating Engineers (ASHVE), American Society for Testing and Materials (ASTM), American Society for Refrigeration Engineers (ASRE), and the National Research Council (NRC) produced a *Standard Method of Test for Thermal Conductivity of Materials by Means of the Guarded Hot Plate*. In 1945, the method was formally adopted as a standard and designated ASTM Test Method C 177. The code set up the requirements for conducting tests and for construction of a guarded hot plate apparatus. It is interesting to note that the standard's adjunct still contains the design drawings for the 1929 version of the NBS guarded hot plate apparatus. ASTM Test Method C 177 became the cornerstone for all thermal insulation testing in North

Robinson was instrumental in disseminating ASTM Test Method C 177 through laboratory intercomparison testing, development of insulation reference materials, and refinement of the measurement method. In 1947, Robinson and colleague Thomas W. Watson extended the temperature range of Van Dusen's guarded hot plate apparatus. A few years later, NBS completed one of the first published laboratory intercomparisons of thermal conductivity tests of insulation [5].



Fig. 2. Henry E. Robinson (1911-1972), installing a pair of cork-board specimens for interlaboratory testing (circa 1948).

America. Over the decades, the standard test method has achieved international acceptance as the most accurate absolute test method for the measurement of thermal conductivity of heat insulators.

This series of tests clearly demonstrated the need for suitable means to calibrate the apparatus at industrial and other laboratories. Shortly thereafter, a program was devised for supplying to industry measured samples of suitable insulating materials for calibration purposes. By 1977 more than 300 laboratories had been served, resulting in considerable improvement in the quality of thermal conductivity data on insulating and building materials reported in technical journals and handbooks. In 1977 the ASTM Committee C-16 on Thermal and Cryogenic Insulating Materials recommended that this program become an official part of the NBS Standard Reference Materials Program. Presently, NIST provides the thermal testing community with several thermal insulation SRMs for thermal resistance.

In 1964, Robinson presented an elegant modification of the test method. The basic design of a line-heat-source guarded hot plate was presented to a thermal conductivity conference sponsored by the National Physical Laboratory in England. The design was reported in Nature [6] as follows:

H. E. Robinson (U.S. National Bureau of Standards) discussed forms of line heat sources that could be used as heaters in apparatus for measurements at lower temperatures on insulating materials in disk and slab form. These new configurations lend themselves more readily to mathematical analysis, they are more simple to use and would appear to be able to yield more accurate results.

The design was novel. In contrast to a (conventional) guarded hot plate that used uniformly distributed heaters, line-heat-source guarded hot plates utilized circular line-heat sources at precisely specified locations. By proper location of the line-heat-source(s), the temperature at the edge of the meter plate can be made equal to the mean temperature of the meter plate, thereby facilitating temperature measurements and thermal guarding. The benefits offered by a line-heat-source guarded hot plate included simpler methods of construction; improved accuracy; simplified mathematical analyses for calculating the mean surface temperature of the plate as well as determining the errors resulting from heat gains or losses at the edges of the specimens; and superior operation under vacuum conditions.

After Robinson, another generation of NBS researchers continued development of the line-heat-source technology. In 1971, M. H. Hahn [7] conducted an in-depth analysis of the line-heat-source concept and investigated several design options. The design, mathematical analysis, and uncertainty analysis for a prototype line-heat-source guarded hot plate were published in 1974 by Hahn, Robinson (posthumously), and D. R. Flynn [8]. Construction of the prototype apparatus was completed in 1978 [9]. Because of the promising results from the prototype, NIST began plans for a second, larger line-heat-source guarded hot plate apparatus. In 1980, a ruling by the U.S. Federal Trade Commission concerning the labeling and advertising of home insulation dramatically accelerated the construction of this apparatus.

With the energy crisis in the 1970s, there was growing demand for thick insulation and a resulting concern from the Federal Trade Commission that the existing standards for insulation measurement, based on 25 mm

thick specimens, were not protecting consumers' interests. In response to concerns from industry and the Federal Trade Commission, NBS expedited development of the one-meter line-heat-source guarded hot plate. Near the end of 1980, the second line-heat-source guarded hot plate apparatus was completed with the efforts of Hahn, B. A. Peavy, F. J. Powell, and others [10]. Industry subsequently testified to Congress [11] that the improved accuracy provided savings of \$90 million per year to consumers in insulation costs alone. It is not surprising that NIST now plans to continue developing the measurement technique into the 21st century with a new design that will extend the current temperature range.

After starting at NBS in 1903, Hobart C. Dickinson was the co-author of several fundamental papers on thermometry. In 1910, he returned to Clark University for his Ph.D. His doctor's thesis was on combustion calorimetry, and his calorimeter design, with some refinements, yielded the most accurate results attainable for its time. From 1912 to 1917 he was in charge of work at the Bureau of Standards on the constants of refrigeration in a program sponsored by the American Society of Refrigeration Engineers. His contributions to this program were papers on the calorimetry of ice and on the thermal conductivity of insulating materials. At the onset of World War I, the Bureau Director, Samuel Wesley Stratton, asked him to assist in the development of aircraft engines, and he participated in the design of the Liberty Engine, which was one of the engineering triumphs of that time. After the war the activities of the section were expanded to embrace automobiles and their behavior on the road. From 1921 to 1923 he organized and directed the research department of the Society of Automotive Engineers at the headquarters in New York City, and in 1933 he was president of that society.

Dickinson was an ardent hiker and preferred to spend his vacations in the mountains. In his later years he served the Potomac Appalachian Trail Club in its program of shelter building. On his first trip to the Canadian Rocky Mountains with the Alpine Club of Canada he took only a small spare blanket and water-repellent sheet when he should have taken all his own bedding. Confronted with bleak prospects, he remembered his measurements on insulating materials, and with his usual resourcefulness gathered balsam boughs in considerable quantity to put between his blanket and his sheet. The result astonished him, and he soon learned that a relatively small thickness of balsam furnished sufficient insulation to keep him pleasantly warm even on freezing nights.

Prepared by Robert R. Zarr.

Bibliography

- [1] H. C. Dickinson and M. S. Van Dusen, The Testing of Thermal Insulators, *ASRE J.* **3** (2), 5-25 (1916).
- [2] M. S. Van Dusen, The Thermal Conductivity of Heat Insulators, *Trans. Am. Soc. Heat. Ventilat. Eng.* **26**, 385-414 (1920).
- [3] D. R. Flynn and D. A. Didion, A Steam Calorimeter Apparatus for Refractories, in *Conference on Thermal Conductivity Methods*, Battelle Memorial Institute, Columbus, Ohio (1961) pp. 81-90.
- [4] M. S. Van Dusen and J. L. Finck, Heat Transfer through Insulating Materials, *American Institute of Refrigeration* **17**, 137-150 (1928).
- [5] H. E. Robinson and T. W. Watson, Interlaboratory Comparison of Thermal Conductivity Determinations with Guarded Hot Plates, in *Symposium on Thermal Insulating Materials: Cincinnati Spring Meeting, American Society for Testing Materials, March 7, 1951, (ASTM STP 119)*, American Society for Testing Materials, Philadelphia, PA (1951) pp. 36-44.
- [6] R. P. Tye, Thermal Conductivity, *Nature* **204**, 636-637 (1964).
- [7] M. H. Hahn, *The Line Heat Source Guarded Hot Plate for Measuring the Thermal Conductivity of Building and Insulating Materials*, Ph.D. Dissertation, Catholic University of America, Washington, DC (1971).
- [8] M. H. Hahn, H. E. Robinson, and D. R. Flynn, Robinson Line-Heat-Source Guarded Hot Plate Apparatus, in *Heat Transmission Measurements in Thermal Insulations (ASTM STP 544)*, American Society for Testing and Materials, Philadelphia, PA (1974) pp. 167-192.
- [9] M. C. I. Siu and C. Bulik, National Bureau of Standards Line-Heat-Source Guarded Hot Plate Apparatus, *Rev. Sci. Instrum.* **52**, 1709-1716 (1981).
- [10] F. J. Powell and B. G. Rennex, The NBS Line-Heat-Source Guarded Hot Plate for Thick Materials, in *Thermal Performance of the Exterior Envelopes of Buildings II: Proceedings of the ASHRAE/DOE Conference (ASHRAE SP 38)*, American Society of Heating, Refrigerating, and Air-Conditioning Engineers, Atlanta, GA (1983) pp. 657-672.
- [11] *National Bureau of Standards Authorization*, Hearing Before the Subcommittee on Science, Technology, and Space of the Committee on Commerce, Science, and Transportation; United States Senate; Ninety-Eighth Congress; First Session, on National Bureau of Standards Authorization; Serial No. 98-3, 67 (February 22, 1983).

Precipitation Hardening of Metal Alloys

Precipitation hardening, or age hardening, provides one of the most widely used mechanisms for the strengthening of metal alloys. The fundamental understanding and basis for this technique was established in early work at the U. S. Bureau of Standards on an alloy known as Duralumin [1,2]. Duralumin is an aluminum alloy containing copper and magnesium with small amounts of iron and silicon. In an attempt to understand the dramatic strengthening of this alloy, Paul D. Merica and his coworkers studied both the effect of various heat treatments on the hardness of the alloy and the influence of chemical composition on the hardness. Among the most significant of their findings was the observation that the solubility of CuAl_2 in aluminum increased with increasing temperature. Although the specific phases responsible for the hardening turned out to be too small to be observed directly, optical examination of the microstructures provided an identification of several of the other phases that were present. The authors proceeded to develop an insightful explanation for the hardening behavior of Duralumin which rapidly became the model on which innumerable modern high-strength alloys have been developed.

In his Institute of Metals lecture [3], Merica summarized the Merica, Waltenberg, and Scott paper as follows: “The four principal features of the original Duralumin theory were these: (1) age-hardening is possible because of the solubility-temperature relation of the hardening constituent in aluminum, (2) the hardening constituent is CuAl_2 , (3) hardening is caused by precipitation of the constituent in some form other than that of atomic dispersion, and probably in fine molecular, colloidal or crystalline form, and (4) the hardening effect of CuAl_2 in aluminum was deemed to be related to its particle size.”

At a symposium devoted to precipitation from solid solution, held nearly four decades after the original papers, R. F. Mehl noted [4], “The early work of Merica, Waltenberg, and Scott was the first contribution to theory: it demonstrated the necessity of a solid solubility decreasing with temperature; this paper had not only science but even prescience, for it suggested that some sort of precipitate-matrix interaction might contribute to hardening, long before coherency was even conceived. There are few better examples of the immense practical importance of the theory in the history of science; before Merica no new age-hardening alloys were discovered—the worker did not know where

to look; following Merica, new age-hardening alloys came in a flood.”

The importance of the theoretical suggestion for the development of new alloys is clear from the historical record [5]. At the end of the 19th century, cast iron was the only important commercial alloy not already known to western technology at the time of the Romans. When age hardening of aluminum was discovered accidentally by Wilm [6], during the years 1903-1911, it quickly became an important commercial alloy under the trade name Duralumin.

The two NBS studies published in 1919 explored both the application of phase diagrams to the phenomenon and the consequences of various heat treatments on the subsequent time evolution of mechanical properties. The latter study tentatively concluded that age hardening of aluminum was a room-temperature precipitation phenomenon and suggested that it should be possible for other alloys to be hardened by a thermal treatment leading to precipitation. Merica et al. suggested that examination of the relevant phase diagrams would reveal which alloys were candidates for such precipitation hardening and would provide both the solutionizing temperature and the range of temperature needed for the precipitation process.

This prescription proved to be astonishingly successful for developing new alloys. It led to a “golden age” of phase diagram determination that lasted two decades. It contributed to the development of a variety of fields in materials science and launched a scholarly debate that overthrew old concepts and definitions concerning alloy phases.

In the 15-year interval between the discovery by Wilm and the suggestion by the Bureau of Standards group, only one other age-hardening system had been discovered, but not published. Aging of Duralumin was thought to be a unique and curious phenomenon. However, by 1932, Merica could tabulate experience with fourteen base metals that had been discovered to harden by precipitation in a total of more than one hundred different alloy combinations. Even that list was already incomplete and underestimated the true worldwide effort that the theoretical suggestion had stimulated. Most of today’s high strength commercial aluminum and nickel-based alloys are precipitation hardened, as are many titanium and iron-based alloys.

Despite the practical success of the theory, there was skepticism since the precipitates did not grow to

optically observable size until long after the hardening had begun. Almost 20 years passed before the precipitates responsible for the hardening were detected experimentally by small-angle x-ray scattering. When finally detected, they became known as Guinier-Preston (GP) zones. Today, they are regarded as true precipitates of a metastable coherent phase, obeying the laws of thermodynamic equilibrium, and are depicted as a metastable feature in phase diagrams.

The precipitation hardening hypothesis is now credited with insights into other phenomena, most particularly slip motions in crystals as presented in the slip interference theory [7]. The latter theory is acknowledged as the precursor to modern dislocation theory [8].



Fig. 1. Paul Merica, ca. 1932 (Reproduced with permission of the AIME).

Paul Dyer Merica had a rather remarkable career [9]. After attending DePauw University for three years, he went to the University of Wisconsin, earning an A. B. degree in 1908. He then taught chemistry in China before receiving his Ph. D. in Metallurgy and Physics from the University of Berlin in 1914. He joined the U.S. Bureau of Standards that same year, holding the positions of research physicist, associate physicist, physicist, and metallurgist. In 1919 he joined the International Nickel Company, rising to become president and director from 1951 until his retirement in 1955. Throughout the course of his career, Merica received numerous awards, including the Franklin Institute Medal, the James Douglas Gold Medal, the Robert Franklin Mehl Award from the Minerals, Metals & Materials Society, the Fritz Medal, and, in 1942, he became a member of the National Academy of Sciences.

Prepared by Sam Coriell with reference to the historical account by John Cahn [5].

Bibliography

- [1] P. D. Merica, R. G. Waltenberg, and H. Scott, Heat Treatment of Duralumin, *Bull. Am. Inst. Min. Metall. Eng.* **150**, 913-949 (1919); also P. D. Merica, R. G. Waltenberg, and H. Scott, Heat-Treatment of Duralumin, *Sci. Pap. Bur. Stand.* **15**, 271-316 (1919).
- [2] P. D. Merica, R. G. Waltenberg, and J. R. Freeman, Jr., Constitution and Metallography of Aluminum and Its Light Alloys with Copper and with Magnesium, *Trans. Am. Inst. Min. Metall. Eng.*, Vol. LXIV, pp. 3-25 (1921); also P. D. Merica, R. G. Waltenberg, and J. R. Freeman, Jr., Constitution and Metallography of Aluminum and Its Light Alloys with Copper and with Magnesium, *Sci. Pap. Bur. Stand.* **15**, 105-119 (1919).
- [3] P. D. Merica, The Age-Hardening of Metals, *Trans. Am. Inst. Min. Metall. Eng.* **99**, 13-54 (1932).
- [4] R. F. Mehl, Introduction and Summary, in *Precipitation from Solid Solution*, R. F. Mehl, et al., American Society for Metals, Cleveland, OH (1959) pp. 1-5.
- [5] J. W. Cahn, A Historical Perspective on the Utilization of Phase Diagrams for Precipitation Hardening, *Bull. Alloy Phase Diagrams* **4**, 349-351 (1983).
- [6] A. Wilm, Physikalisch-metallurgische Untersuchungen über magnesiumhaltige Aluminiumlegierungen, *Metallurgie* **8**, 225-227 (1911).
- [7] Z. Jeffries and R. S. Archer, The Slip Interference Theory of the Hardening of Metals, *Chem. Metall. Eng.* **24**, 1057-1067 (1921).
- [8] C. S. Smith, *Dictionary of Scientific Biography*, Vol. VII, Charles Scribner's Sons, New York (1973) pp. 92-93.
- [9] Zay Jeffries, Paul Dyer Merica, in *Biographical Memoirs*, Vol. XXXIII, National Academy of Sciences, Columbia University Press, New York (1959) pp. 226-240.

Construction and Operation of a Simple Homemade Radio Receiving Outfit

The 1922 Bureau of Standards publication, *Construction and Operation of a Simple Homemade Radio Receiving Outfit* [1], is perhaps the best-known of a series of publications on radio intended for the general public at a time when the embryonic radio industry in the U.S. was undergoing exponential growth.

While there were a number of earlier experiments with radio broadcasts to the general public, most historians consider the late fall of 1920 to be the beginning of radio broadcasting for entertainment purposes. Pittsburgh, PA, station KDKA, owned by Westinghouse, received its license from the Department of Commerce just in time to broadcast the Harding-Cox presidential election returns. In today's world where instant global communications are commonplace, it is difficult to appreciate the excitement that this event generated.

News of the new development spread rapidly, and interest in radio soared. By the end of 1921, new broadcasting stations were springing up all over the country. Radios were selling faster than companies could manufacture them. The demand for information on this new technology was almost insatiable. The Radio Section of the Bureau of Standards provided measurement know-how to the burgeoning radio industry as well as general information on the new technology to the public. Letters to the Bureau seeking information on radio technology began as a trickle, and then soon became a flood. Answering them became a burden.

Circular 120, published in April 1922, began: "Frequent inquiries are received at the Bureau of Standards for information regarding the construction of a simple receiving set which any person can construct in the home from materials which can be easily secured. This publication has been prepared to meet these inquiries." The circular also noted that the Bureau was cooperating with the Bureau of Markets and Crop Estimates of the Department of Agriculture. In the early days of radio, broadcasts to farmers of crop price reports were an important public service.

In 1921 factory-made radios were very expensive. Many of them cost more than \$2000 in today's dollars, and less affluent families could not afford to have one. When the Bureau published this circular (which sold for only five cents) on how to build a simple crystal radio at home, it was an instant success. Thousands of orders

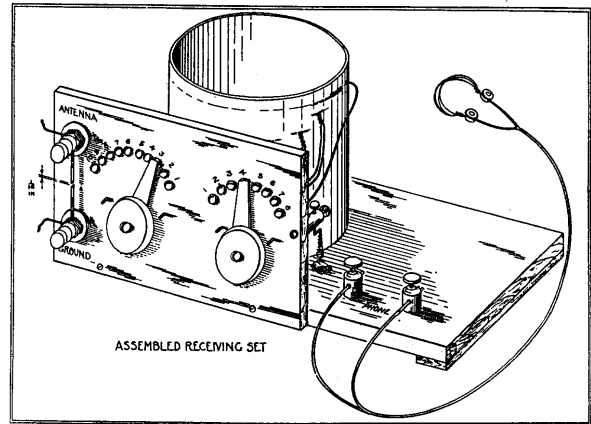

Fig 1. The crystal radio described in Circular 120.

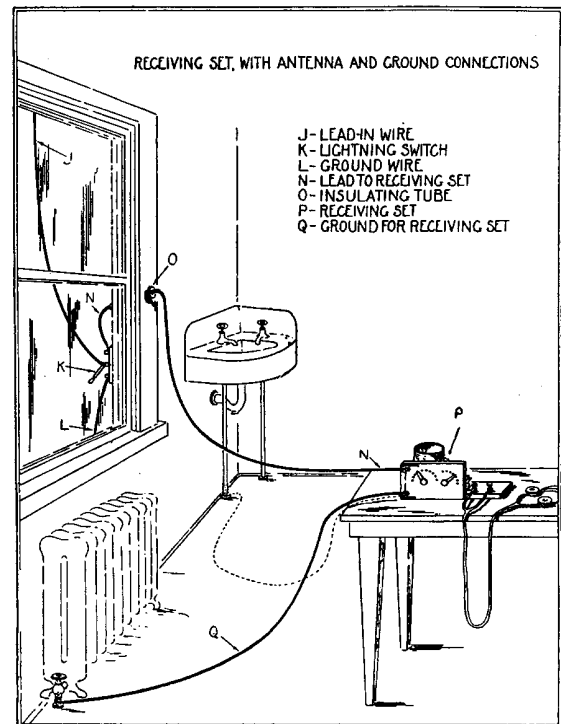

Fig. 2. Diagram showing the antenna and ground connections to the radio.

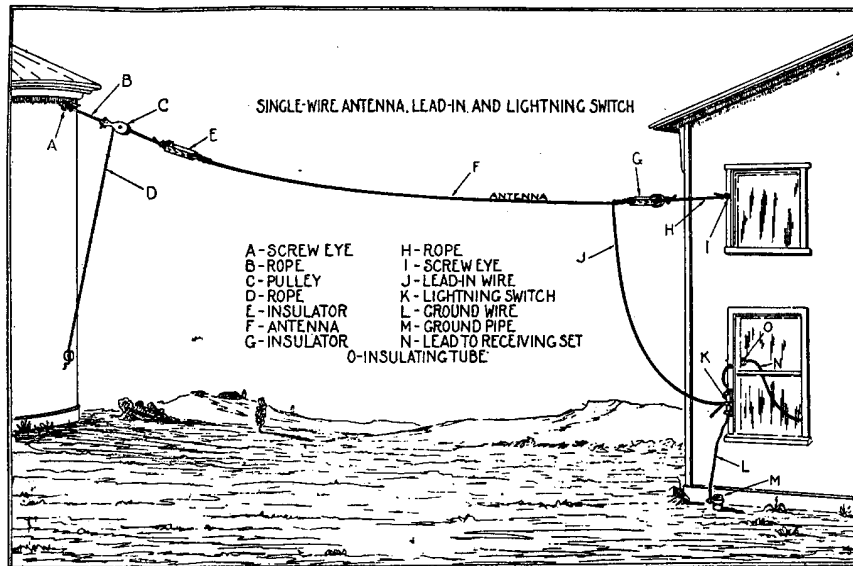

Fig. 3. Details of the outdoor antenna recommended for use with the crystal radio.

flowed in from every state. The circular showed how almost any family having a family member handy with simple tools could make a radio. The circular states “Satisfactory results have been obtained from sets constructed according to these instructions by persons having no previous experience with radio.” The authors stated that the cost of the materials for the radio and associated headphones and antenna system should not exceed \$10.

Newspapers around the country urged readers interested in radio to order a copy, and in many cases they reprinted the entire article. Even today, antique radio collectors searching attics and basements often come across dusty home-built crystal radio sets that were obviously constructed using the Bureau’s plans. No doubt the remarkably rapid growth of the radio industry in the U.S. during the 1920s (analogous to the growth in Internet-related businesses today) was aided considerably by information provided to the public by the Bureau, such as this circular and the other items noted in the bibliography [2-6].

Circular 120 proved such a success that the Bureau published a number of other circulars on radio technology intended for the general public, as noted in the bibliography. All were popular. In some cases, commercial radio manufacturers copied the circuits proposed by the Bureau. During the same era, other radio publications of the Bureau captured public attention as well, though perhaps in smaller quantities than Circular 120. *Radio Instruments and Measurements* [7], Circular 74, published first in 1918 with a second edition published in 1924, became a best seller in the

post-WW I era. Its principal authors were most likely J. H. Dellinger, J. M. Miller, F. W. Grover, and G.C. Southworth. The authors of Circular 120 are not stated, but some of those same individuals likely contributed to it. J. Howard Dellinger’s story is particularly interesting. He came to the Bureau in 1907 as a laboratory assistant at \$900 per year, and retired as Chief of the Central Radio Propagation Laboratory in 1948. He headed the Radio Section for much of its existence. Appendix D of Reference [9] is a biography of Dellinger.

The Principles Underlying Radio Communication [8], Signal Corps Radio Communication Pamphlet No. 40, published in 1919 and issued in a revised edition in 1922, is another interesting example of a popular radio book. Written by the Bureau of Standards for training Army Signal Corps officers, it was an expanded and updated version of Circular 74, noted above, but was also widely used by college students and others studying radio. In spite of the “pamphlet” designation, it was actually a 600-page book. Thomas Edison said “. . . This is the greatest book on this subject that I have ever read, and I want to congratulate you and your Bureau on its production.”

While the general public was interested in radio information for the lay person, the fledgling radio industry needed in-depth technical assistance from the Bureau, which it got. The Bureau helped radio manufacturers make better measurements for quantities such as resistance, capacitance, voltage, and frequency. Results of Bureau research on antennas and radio wave propagation, direction finders, vacuum tube characteristics, and testing were eagerly utilized by major

companies such as General Electric, Westinghouse, Western Electric, and RCA, as well as by a myriad of small radio companies no longer in existence. At the same time that the Bureau was providing information to people constructing radios on their kitchen tables, Radio Section staff members were presenting technical papers on radio at conferences and in journals such as the *Proceedings of the Institute of Radio Engineers*. A good example of the latter is the classic work by John Miller, who discovered and explained “the Miller effect”—a feedback effect in triode vacuum tubes that limited their ability to amplify at radio frequencies [9].

Circular 120 described in detail not only the crystal radio itself but also how to construct an antenna and ground system. To minimize the cost, the circular suggested winding the tuning coil on a discarded cylindrical oatmeal box. For years afterwards, home experimenters used oatmeal boxes as coil forms for homemade radios. The crystal radio did not require batteries, but it did require the user to purchase a commercially made set of headphones (or telephone receivers as they were called in those days), since that accessory was not suitable for home construction.

One can just imagine the thrill of a farm family that had never heard a radio broadcast before trying the new set for the first time, and one of the family members crying out, “Come listen! I am hearing something!” The electronics revolution was underway and the Bureau played a significant part in accelerating the new technology.

Prepared by Brian Belanger.

Bibliography

- [1] *Construction and Operation of a Simple Homemade Radio Receiving Outfit*, Circular of the Bureau of Standards, No. 120, U.S. Government Printing Office, Washington, DC, April 24, 1922.
- [2] *Construction and Operation of a Two-Circuit Radio Receiving Equipment with Crystal Detector*, Circular of the Bureau of Standards, No. 121, U.S. Government Printing Office, Washington, DC, July 17, 1922.
- [3] *Sources of Elementary Radio Information*, Circular of the Bureau of Standards, No. 122, U.S. Government Printing Office, Washington, DC, June 22, 1922. (Updated to second edition, Sept. 12, 1923.)
- [4] *Description and Operation of an Electron-tube Detector Unit for Simple Radio Receiving Outfits*, Circular of the Bureau of Standards, No. 133, U.S. Government Printing Office, Washington, DC, November 10, 1922.
- [5] *Auxiliary Condensers and Loading Coil Used with Simple Homemade Radio Receiving Outfits*, Circular of the Bureau of Standards, No. 137, U.S. Government Printing Office, Washington, DC, Feb. 23, 1923.
- [6] *Description and Operation of an Audio-Frequency Amplifier Unit for Simple Radio Receiving Outfits*, Circular of the Bureau of Standards, No. 141, U.S. Government Printing Office, Washington, DC, March 24, 1923.
- [7] *Radio Instruments and Measurements*, Circular of the Bureau of Standards C74, U.S. Government Printing Office, Washington, DC, 1918. (Second edition published in 1924.)
- [8] *The Principles Underlying Radio Communication*, Signal Corps Radio Communication Pamphlet No. 40, U.S. Government Printing Office, Washington, DC (1919). (Written by Bureau staff members.)
- [9] W. F. Snyder and C. L. Bragaw, *Achievement in Radio: Seventy Years of Radio Science, Technology, Standards, and Measurement at the National Bureau of Standards*, NBS Special Publication 555, National Bureau of Standards, Boulder, CO (1986).

Methods for Standardizing and Testing Precision Gage Blocks

This paper by C. G. Peters and H. S. Boyd [1] summarizes the efforts at NBS in the early 1920s to improve the calibration of precision gage blocks. Since their invention at the turn of the twentieth century, gage blocks have been the major source of length standardization for industry, and their calibration is one of the most important high precision calibrations made in dimensional metrology. In most measurements of such enduring importance, it might be expected that the measurement would become much more accurate and sophisticated over 80 years of development. Because of the extreme simplicity of gage blocks, this has only been partly true. The most accurate measurements of gage blocks have not changed dramatically in accuracy in the last 70 years, because one of the major sources of uncertainty is the geometry of the gaging face of the block. The very best gage blocks have always had the gaging surfaces flat to 20 nm or better, but these blocks were very rare at the turn of the last century. This level of geometry simply was not necessary to obtain the measurement accuracy needed by industry of the time. What has changed is the much more widespread necessity of such accuracy. Measurements that previously could be made only with the equipment and expertise of a national metrology laboratory are routinely expected in private industrial laboratories.

By the end of the nineteenth century, the idea of interchangeable parts begun by Eli Whitney had been accepted by industrial nations as the model for industrial manufacturing. One of the drawbacks to this new system was that, in order to control the size of parts, numerous gages were needed to check the parts and set the calibrations of measuring instruments. The number of gages needed for complex products, and the effort needed to make and maintain the gages, was a significant expense. The major step toward simplifying this situation was made by C. E. Johansson, a Swedish machinist.

Johansson's idea, first formulated in 1896 [2], was that a small set of gages that could be combined to form composite gages could reduce the number of gages needed in the shop. For example, if four gages of sizes 1 mm, 2 mm, 4 mm, and 8 mm could be combined in any combination, all of the millimeter sizes from 1 mm to 15 mm could be made from only these four gages. Johansson found that if two opposite faces of a piece of steel were lapped very flat and parallel, two blocks

would stick together when they were slid together with a very small amount of grease between them. The width of this "wringing" layer is about 25 nm, which was so small relative to the tolerances needed at the time that the block lengths could be added together with no correction for interface thickness. Eventually, the wringing layer was defined as part of the length of the block, allowing the use of an unlimited number of wrings without correction for the size of the wringing layer.

In the United States, Henry Ford enthusiastically adopted the idea, and the use of gage blocks was eventually adopted as the primary transfer standard for length in industry. By the beginning of World War I, the gage block was already so important to industry that the Federal Government had to take steps to ensure the availability of blocks. At the outbreak of the war, the only supply of gage blocks was from Europe, and this supply was interrupted.

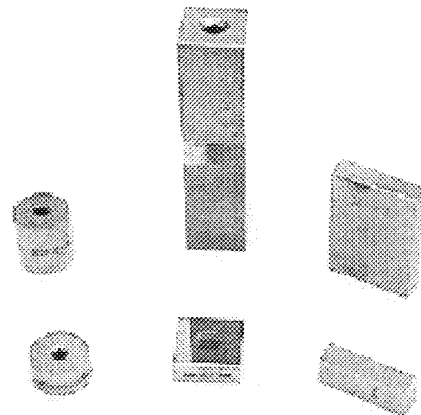

Fig. 1. Gage Blocks. The blocks on the left were manufactured at the Bureau of Standards during World War I. In the center are the descendants of the Bureau of Standards blocks, square "Hoke" style blocks. The rectangular style is the international standard, used all over the world.

In 1917 inventor William Hoke came to NBS proposing a method to manufacture gage blocks equivalent to those of Johansson [3]. Funds were obtained from the Ordnance Department for the project, and 50 sets of 81 blocks each were made at NBS. There were problems,

of course. The major problem was the difficulty of making a flat surface. Nearly any error in the system tends to produce block faces shaped like a dome. The solution was to make a hole in the center of the block, preventing the dome in the center. While nearly all gage blocks today are rectangular or square cross-section, the holes in the center of square blocks are the direct descendants of the NBS blocks, and are called “Hoke blocks.”

Besides making gage blocks, NBS was also, obviously, engaged in measuring gage blocks. While the standard of length, the International Prototype Meter, was a line scale, the precedent of comparing length to the wavelength of light was well established. Albert Michelson, the great American scientist well known for his speed of light measurements, had been asked by the International Committee of Weights and Measures to measure the meter in terms of light waves in the early 1890s. By 1893 Michelson had compared the International Prototype Meter to the wavelength of the red emission line of cadmium. The average value of 1,553,164.5 wavelengths at 15 °C and standard atmospheric pressure is remarkably close to the current value.

By 1920 work was underway at the International Bureau of Weights and Measures (BIPM) and in some of the national measurement institutes to build interferometers to measure end standards. The work of Peters and Boyd [1], published in the *NBS Journal of Research*, is a very complete report on the NBS effort.

The paper begins with a basic discussion of interference and the accuracy of the optical method of measurement of length, flatness, and parallelism. The uncertainty estimates, for blocks of good geometry, are about the same as currently realized. The interference section leads to a discussion of measuring flatness using a master optical flat and an interferometric viewer: the Pulfrich Viewer. This same instrument is still used at NIST to calibrate master optical flats. The discussion of the interpretation of interference fringes is still an accurate and practical teaching tool.

That section is followed by a section discussing one of the more subtle problems with gage blocks, the effects of wringing blocks together into a stack. Their eventual advice is the same we give out today: make up a stack of three or more blocks that equal the nominal height of another block, e.g., compare a stack of 2 mm, 3 mm, and 5 mm to the 10 mm block. They show examples of the growth of two stacks, and even throw in a warning not to rub the block on the user’s wrist to make the wringing film more substantial. This horrid practice, subjecting steel gage blocks to salt water, is still used and occasionally showed up in textbooks into the 1960s.

The calibration of gage blocks is covered in the next few sections. The details include the thermal expansion of gage blocks and their temporal stability, with examples of each of these effects. Finally, there are three sections on comparing gage blocks, the development of standard gages, and the use of gage blocks to measure other types of gages.

The section on comparing gages of the same nominal length describes how two blocks can be compared by wringing them next to each other on the same reference plate. The fringe patterns are discussed, and the use of a third block to break the ambiguity between concave and convex curved blocks is discussed. The next section explains how to generate a set of gages by subdivision. By comparing two 50 mm blocks to a 100 mm block, and then comparing the two 50 mm blocks to each other, an accurate calibration of the 50 mm blocks is made. Using wrings of two or more blocks, the entire set of gage blocks can be generated. Included is a short discussion of how two end blocks with small lines on them can be wrung to the ends of a gage block, making the stack into a line scale. The distance between the lines is measured with the two auxiliary blocks wrung together, and then again with the unknown gage wrung between them. The difference is the length of the unknown gage. This method is still occasionally used because of the high accuracy of instruments designed to measure line standards, such as meter bars.

Finally, there is a section showing how interferometric methods can be used to compare gage blocks to gage balls and cylinders.

Overall, the paper is surprisingly modern in its treatment of interferometry as a length measurement tool. Moreover, the use of examples and line drawings to explain the material makes the paper a useful introduction to the subject for beginning metrologists.

Chauncy G. Peters was born in Emerald, Wisconsin, in 1897. After obtaining a physics degree at Ripon College, he did graduate work at the University of Wisconsin. From Wisconsin, in 1913, he was brought to NBS by Samuel W. Stratton, the first Director. Stratton had worked with Albert Michelson at the University of Chicago and had a personal interest in optics. He also had long expressed concern over the foreign monopoly of high quality optical glass, and the Optics Division of NBS became one of his major interests. Peters had a long and active career as Staff Chief for Interferometry from 1919 until his retirement in 1949 [3].

After his interferometry studies of the 1920s Peters began studies of the optical and mechanical properties of glasses, eventually working with Frederick Knoop on diamond indenters for microhardness testing. One style indenter invented by Peters was later commercialized as

the “Tukon Hardness Tester.” During World War II his primary work was to investigate making holes in diamonds by electric discharge methods and to devise methods of using these diamonds as wire dies. His career then came full circle, returning to interferometric length testing in a paper *Interference Methods for Producing and Calibrating End Standards*, with W. B. Emerson in 1950 [4].

H. S. Boyd is, unfortunately, a more obscure figure. He was the co-author with Peters on a number of interferometry publications, but was an NBS employee for only a few years. Checking the phone books in the NBS Historical Archives for the years 1910 to 1930 shows entries for Boyd from 1919 to 1922; thus it appears that he was a scientist or technician in the Interferometry Section, but left NBS in 1922.

Prepared by Ted Doiron.

Bibliography

- [1] C. G. Peters and H. S. Boyd, Interference Methods for Standardizing and Testing Precision Gage Blocks, *Sci. Pap. Bur. Stand.* **17**, 677-713 (1922).
- [2] F. H. Rolt, *Gauges and Fine Measurements*, 2 vols., Macmillan and Co., London (1929).
- [3] Rexmond C. Cochrane, *Measures for Progress: A History of the National Bureau of Standards*, NBS Miscellaneous Publication 275, National Bureau of Standards, Washington, DC (1966).
- [4] Chauncey G. Peters and Walter B. Emerson, Interference Methods for Producing and Calibrating End Standards, *J. Res. Natl. Bur. Stand.* **44**, 419-442 (1950).

Recommended Minimum Requirements for Small Dwelling Construction

From its beginning, NBS had studied properties of building materials in order to meet the construction industry's recognized need for specific technical information. It was not until 1921, however, when Herbert Hoover became Secretary of Commerce, that these activities were brought together under a Division of Building and Housing and grew into a significant and effective program. The impact of this effort was noted with the publication of the Building and Housing Series, and perhaps the most important document in the series was the very first publication, *Recommended Minimum Requirements for Small Dwelling Construction* [1]. This publication is often viewed as the first national model building code, and the Building and Housing Series [2] established NBS as an important source of information to serve the public and stimulate economic growth.

The significance of this publication and the events leading to its release are documented most clearly in the book, *Measures for Progress* [3].

“... Hoover entered office determined to recover the Nation, singlehandedly if necessary, from its wartime splurge, its consequent depletion of resources, and the general economic demoralization into which it had plunged. Recovery, by raising as rapidly as possible the level of productivity, was the first essential; reconstruction would follow.

“Hoover's plan for recovery, in order to open employment offices again and start the wheels of industry, was to stimulate building and housing, lend direct assistance to both new and established industries, and minister to the new aviation and radio industries. Reconstruction, providing long-range benefits to the economy, aimed at a progressive elevation of the standard of living, principally by a campaign to eliminate economic wastes.

“Although the building trades themselves badly needed reconstruction, they offered the most likely means of achieving immediate and massive results in reviving depressed industry and providing maximum employment across the Nation. The housing shortage as a result of the war was estimated at more than a million units. Stimulate homebuilding, and the

brick, lumber, glass, hardware, plumbing, appliance, textile, and furniture industries and all that served and supplied them would revive.”

Hoover's new division of building and housing set its sights on revising an infrastructure consisting of poor housing designs, costly materials and labor, outdated building and zoning regulations that were barriers to development, and a shortage of mortgage funds. The circumstances at the time of issuance of *Recommended Minimum Requirements for Small Dwelling Construction* are summed up in a preliminary report of the 1920 Senate Committee on Reconstruction and Production:

“The building codes of the country have not been developed upon scientific data but rather on compromise; they are not uniform in practice and in many instances involve an additional cost to construction without assuring more useful or more durable buildings.” [4]

NBS's program was announced with national publicity. Information was to be published on home building, home ownership, technical revisions to construction codes, plumbing codes, zoning ordinances, etc., suitable for adoption within codes or as separate ordinances. Beyond these recommended minimums, NBS was to provide standards for better construction practices that would improve workmanship, seek simplification and standardization of building materials, reduce dimensional variations and deviations, and otherwise serve to lower costs. To meet these objectives, *Recommended Minimum Requirements for Small Dwelling Construction* included an extended appendix in which information was presented on good construction going beyond the limits of minimum safe standards.

The spring of 1922 saw the start of a major spurt in the construction of housing. Secretary Hoover chaired the National Advisory Council of the Better Homes in America movement. This program mobilized chambers of commerce, women's clubs, and better homes and gardens organizations to promote more and better housing across the country. The Department of Commerce's housing division, working with NBS and in consultation with building officials, architects, engineers, fire chiefs, materials experts, and their related associations, gathered and organized technical

information, statistics, and other data. NBS published *Recommended Minimum Requirements for Small Dwelling Construction* as the first in the B&H Series [5]. The consumer-oriented documents sold hundreds of thousands of copies and were reprinted and serialized in newspapers and magazines.

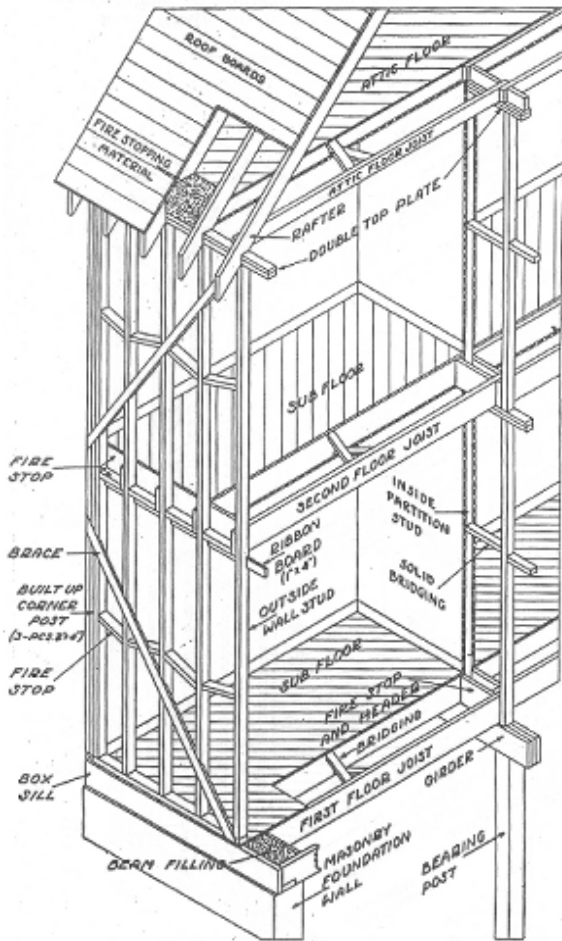

Fig. 1. Approved details of balloon frame construction.

New homes construction in 1922 was reported at over 700,000 units, nearly doubling the total from the prior year. By 1925 housing production had risen to 937,000 units. The 8-year period of 1922-1929 saw an average of 750,000 homes per year completed, far in excess of the 450,000 units per year estimated as being necessary to overcome the postwar shortage.

Recognition of the importance of sound and economical construction, coupled with home ownership as a significant contributor to the welfare of the nation, was manifested in December 1931 when over 3000 civic

leaders from around the country came to Washington to attend the President's Conference on Home Building and Home Ownership. The conference emphasized improvements in the building code situation and the importance of sound regulations.

In the spring of 1932 *Recommended Minimum Requirements for Small Dwelling Construction* was re-issued as Building and Housing Publication No.18 (BH18) [4] and superseded BH1. The 102 page publication consisted of three parts: Introduction, Minimum Requirements for Safe and Economical Construction of Small Dwellings, and Appendix. The introduction provides background, purpose and intent information for the reader. The minimum requirements are organized by types of construction with separate sections describing different types of horizontal and vertical space dividers and miscellaneous components (e.g., chimneys and fireplaces, heating appliances). The bulk of the document is the appendix, which provides detailed technical information on a wide variety of materials and methods of construction assembled from a number of industry sources.

BH18 was a continuation of the work of the Department of Commerce's Building Code Committee. The committee consisted of seven members (four of whom were members of the original group) and was chaired by William K. Hatt, professor of civil engineering and director, Laboratory for Testing Materials, Purdue University. The committee continued to operate under the Division of Building and Housing of NBS with James S. Taylor, Chief. George N. Thompson of NBS, who served as Secretary of the Committee from its inception, provided direct liaison with NBS and thereby contributed the scientific and engineering knowledge necessary to develop the technical information and answer committee questions throughout the deliberations.

Recommended Minimum Requirements for Small Dwelling Construction was the forerunner for the Federal Housing Administration's Minimum Property Standards, which provided quality requirements for the post World War II housing construction boom, and for the *One and Two Family Dwelling Code (OTFDC)* [6], published first in 1971 by the three model code organizations. In 1972 the Council of American Building Officials (CABO) was formed, and later in that decade CABO took over the publication of the OTFDC. This code provides the technical requirements for most of the Nation's conventionally constructed housing. In 1994 the CABO constituency formed the International Code Council (ICC), and in 2000 the ICC published the *International Residential Code* [7], which supersedes the OTFDC.

In 1933, as a result of an economy program in the Federal Government, the American Standards Association (ASA) established a Building Code Correlating Committee to take over the work of the Department of Commerce's Building Code Committee. Technical questions that arose in ASA sectional committees continued to form the basis for many scientific investigations at NBS. George N. Thompson became chairman of ASA's Building Code Correlating Committee, then chairman of its successor, the Construction Standards Board.

NBS provided leadership in many important construction standards activities by directly sponsoring the following American Standards: the National Electric Safety Code (ASA C2); the Safety Code for Elevators (ASA A17); Building Code Requirements for Minimum Design Loads in Buildings and other Structures (ASA A58); and Building Code Requirements for Masonry (ASA A41). In addition, NBS staff members participated actively in the development of other American Standards for building construction including: the National Electrical Code (ASA C1); the Safety Code for Building Construction (ASA A10); Building Code Requirements for Fire Protection and Fire Resistance (ASA A51); and the Safety Code for Mechanical Refrigeration (ASA B9). These standards were recognized in virtually all state, local, and model building codes in the U.S., and by all federal construction agencies. They unified technical requirements for buildings based on consensus of the construction industry, and contributed substantially to the efficiency and economy of construction while improving safety and quality. NBS research results, many of which are documented in the 150 titles of the NBS Building Materials and Structures Reports published between 1938 and 1957, provided the foundation for many of the provisions. Many of their technical requirements survive as the basis for today's construction standards and codes.

When the American Standards Association decided to incorporate in 1947, the U.S. Department of Commerce withdrew as a member body, and NBS

ceased to lead construction standards management activities until its participation in the renamed American National Standards Institute's Construction Standards Management Board was renewed in the 1970s. However, technical contributions to and participation in consensus standards committees has continued unabated to the present time. A number of particularly significant contributions are described elsewhere in this centennial publication.

Prepared by Joel P. Zingesser.

Bibliography

- [1] F. P. Cartwright and the Building Code Committee of the Department of Commerce, *Recommended Minimum Requirements for Small Dwelling Construction*, Building and Housing Publication BH1, National Bureau of Standards, U.S. Government Printing Office, Washington, DC, July 1922.
- [2] For a summary, see P. R. Achenbach, *Building Research at the National Bureau of Standards*, Building Science Series 0, National Bureau of Standards, U.S. Government Printing Office, Washington, DC, October 1970.
- [3] R. C. Cochrane (with J. R. Newman), *Measures for Progress, A History of the National Bureau of Standards*, NBS Miscellaneous Publication 275, National Bureau of Standards, U.S. Department of Commerce (1966).
- [4] Department of Commerce, Building Code Committee, *Recommended Minimum Requirements for Small Dwelling Construction*, Building and Housing Publication No. 18, National Bureau of Standards, U.S. Government Printing Office, Washington, DC (1932).
- [5] Additional publications included: BH2-*Recommended Minimum Requirements for Plumbing in Dwellings and Similar Buildings*; BH3-A *Zoning Primer*; BH4-*How to Own Your Home*; BH5-*A Standard State Zoning Enabling Act*; BH6-*Recommended Minimum Requirements for Masonry Wall Construction*; BH7-*Minimum Live Loads Allowable for Use in Design of Buildings*; BH8-*Recommended Practice for Arrangement of Building Codes*.
- [6] International Conference of Building Officials, Inc., Building Officials and Code Administrators International, Inc., and Southern Building Code Congress International, Inc., *One and Two Family Dwelling Code*, 1971.
- [7] International Code Council, Inc., *International Residential Code*, 2000.

Visibility of Radiant Energy

This classic paper [1] from 1923 reports the results of one of the most enduring projects ever undertaken at NBS, research into the physical description of human vision. The principal result of this work was the “visibility curve,” a quantified model of how well a typical person can see the different wavelengths (colors) of light. Today this model function, essentially unchanged, underlies all physical measurements of photometric quantities and their interpretation in photometric units of measure.

It has been understood since the time of Isaac Newton that white light is a combination of a spectrum of different wavelengths, each seen as a pure color. Light is a form of radiant energy, with a power that can be measured in watts, but the connection between this physical description (or the “mechanical” description as it was then known) and the visual result in the human eye was not well established. This was the challenge undertaken by K. S. Gibson and E. P. T. Tyndall: to carry out a study of the visibility of radiant energy or, in quantitative terms, the ratio of the luminous (perceived) power to the radiant (physical) power at the different wavelengths in the spectrum.

Gibson and Tyndall were neither the first nor the last to study the visibility of light, but their work is perhaps the most notable for its thoroughness, timeliness, and impact. The first experiments on this subject were undertaken by Fraunhofer in 1817, and the first energy measurements were made by Langley in 1883 [2]. By 1905, Goldhammer had crystallized the idea of a definite relationship between visibility and power at each wavelength, and at the young NBS, Nutting introduced the term “visibility curve” in 1908 [3]. The Bureau’s forefront research continued through the subsequent decade, leading to the major study of the sensitivity of the eye across the spectrum by Coblentz and Emerson in 1918 [4].

However, these and other data accumulated around the world were not consistent. Different experimental methods were a chief cause. In the equality-of-brightness matching method, two lights were projected onto a split-screen viewer, while with the flicker method, two lights were alternately projected on a simple viewing screen in rapid succession. In each case, the lights were adjusted in a known way until an observer declared a brightness match. The equality-of-brightness method was the more precise of the two, but only so long as the color quality of both lights was similar. When the colors

were very different, different observers would make different matches. The flicker method did not give as sharp results for similar lights, but the data quality was not much affected by color differences.

Seeing the need to bring closure to the question, Edward P. Hyde (who had left the NBS staff in 1908 to go to the General Electric Nela Research Laboratories), as president of the U. S. National Committee of the International Commission on Illumination (the CIE), requested the Bureau of Standards to make an additional investigation using the so-called step-by-step method. This form of equality-of-brightness matching, where comparisons were made between a series of only slightly different colors, held promise as a means of obtaining more reliable data.

Gibson and Tyndall were neither the first nor the last to study the visibility of light, but their work is perhaps the most notable for its thoroughness, timeliness, and impact.

NBS undertook the challenge under the sponsorship of General Electric. Director Burgess appointed a special committee of experts to oversee the work, which was conducted by Gibson and Tyndall. The University of Nebraska loaned a Brace spectrometer to the Bureau, to be incorporated into an elaborate apparatus that made the best use of the Bureau’s primary standard lamps. Special care was taken in all aspects of the experiment; issues that were believed to affect the consistency between previous experiments—such as the size and brightness of the viewing fields—received particular attention.

The results included the brightness-matching data from 52 observers, some of them in common with previous studies. As hoped, the new equality-of-brightness data were within the range of data obtained with flicker methods (except in the outer regions of the spectrum).

However, the strength of the paper was not so much in the new experimental results as it was in its extensive analysis and critical review of all existing data. Gibson

and Tyndall carefully compared their own results with those of their predecessors and proposed a mean visibility curve based upon the accumulated data from more than 200 different observers. They were guided in this task by the prevailing theories of the day, which were believed to dictate certain balance in the curve [5].

The result was a smash success, quickly winning wide acclaim. In 1924, the 6th Session of the CIE adopted the Gibson-Tyndall curve as a world standard. In 1933, the Comité International des Poids et Mesures (the supervisory body of the world's metric system) followed suit.

The achievement of Gibson and Tyndall might have remained an academic one were it not for the changing needs in metrology and the advances of technology. As surprising as it might seem today, until 1948 there was no universal standard for the brightness of light. The "standard candle," once made from whale oil, is a part of popular lore, but in reality, different laboratories each had their own favorite "standard." Some used gas lamps, some used liquid-fueled lamps, and following the trend towards electric lighting at the turn of the century, some (including NBS) used electric lamps. It was difficult to compare lighting devices to the standards, and the standards to each other, because different fuels and different lamp constructions would produce lights of different color. The only available instruments that could reliably report how bright a light appeared, or how lights compared to standards, were humans, and as we already know, equality-of-brightness matching was unreliable when the colors were significantly different.

Research in the 1930s, interrupted by World War II, led to international agreement in 1948 to use a platinum-point blackbody as the sole international standard of the luminous intensity of light. When objects are hot, they give off light. By "blackbody," we mean that the object does not reflect ambient light—all the light we see from it is thermally generated, an intrinsic function of the object's temperature. The trick was to operate a blackbody at a temperature that anyone could reproduce—in this case, the temperature of molten platinum as it begins to freeze while cooling. Many felt that this would provide the necessary world-wide stability and uniformity. A unit of measure of luminous intensity was then defined, now known as the candela, to relate the new blackbody standard to a typical standard candle of times past.

This development had an unintended consequence. Unlike the previous lamp and flame standards, the behavior of blackbodies are calculable from first principles, using Planck's radiation law. We had a light source that we understood in detail. The other piece of the puzzle was an understanding of how the eye

responded to this light, and this is where the work of Gibson and Tyndall fit in. Suddenly, it became feasible to design and build electrical devices to measure brightness just as a human would, or at least the ideal human modeled by the Gibson-Tyndall curve 25 years earlier. The definition of the candela in 1948 had the effect of eliminating the need to have someone actually looking through a visual comparator, a process today called "visual photometry." It began an era of "physical photometry" in which luminous intensity could be evaluated through more objective measurements, yielding better precision and accuracy.

As time went on, the platinum-point standard fell into disfavor. The devices were difficult to maintain, their temperature was much lower than that of common electric lamps, and the melting-point temperature itself was too uncertain. This limited how well their emission spectra could be calculated. Finally, in 1974, Bill Blevin from the National Measurement Laboratory in Australia and Bruce Steiner at NBS published the seminal paper that said 'enough is enough.' They formally proposed that the SI base unit for photometry, the candela, be redefined so as to provide an exact numerical relationship between it and the SI unit of power, the watt [6]. They stated the case so well that, in 1979, the world metrology community effected a redefinition of the candela.

The 1979 redefinition puts even more reliance upon the work of Gibson and Tyndall. It says, "the candela is the luminous intensity, in a given direction, of a source that emits monochromatic radiation of frequency 540×10^{12} hertz and that has a radiant intensity in that direction of (1/683) watt per steradian." That specific frequency corresponds to a wavelength of 555 nm, which is where the peak of the Gibson-Tyndall curve lies. In order to determine the luminous intensity of light at other wavelengths, one uses the Gibson-Tyndall curve (more precisely, its modern, smoothed form, denoted as $V(\lambda)$) to find the corresponding number of watts. The era of visual photometry is truly over. Today, essentially all photometry is physical photometry, relying upon this definition and the $V(\lambda)$ curve to characterize any real light source or the performance of any tangible light detector.

This success of the Bureau in the early 1920s led to another important success towards the end of the decade. Having solved the problem of modeling brightness, Bureau staff next turned their attention to modeling color. This was a field that remained active well into the 1960s, but in those early days, a young staff member named Deanne Judd made his mark through another compelling analysis of existing data, resulting again in establishing the principles and methods that led to international consensus [7]. In 1931, the CIE adopted the

system for quantitative color nomenclature that has continued to be used for 70 years. Judd, serving as the U.S. Joint Representative to the CIE, was one of the principal architects of that standard. His paper laid out technical recommendations that were accepted a year later, together with additional data developed by John Guild of the National Physical Laboratory (NPL) in the UK [8].

The system of colorimetry that Judd envisioned in 1930 has been a foundation for technologies not even dreamed of then—color photography (Kodachrome was invented in 1935), color television, modern color printing, and digital imaging. The tools of today’s electronic commerce—color scanners, color-calibrated computer monitors, and all manner of color printers—all still rely on the 1931 CIE color system for “device independent” color specifications.

As beautiful as the Gibson and Tyndall work was, it was not without warts. The most famous occurs in the blue-violet portion of the spectrum, where they were forced to choose between conflicting data. They wrote, “The I. E. S. [Illuminating Engineering Society] data in the violet have been accepted by the authors for lack of any good reason for changing them, but the relative as well as absolute values are very uncertain and must be considered as tentative only.” Their guess was wrong, but it so quickly earned acceptance that it did not remain “tentative” for very long. Years later, Judd attempted to institute an “improved” version of the visibility curve [9], but the Gibson and Tyndall version had been so thoroughly adopted that the revision never gained wide usage.

The second problem is more subtle and beguiling. The world of Gibson and Tyndall did not include the narrow-band light sources so common today: the phosphors in fluorescent lamps and CRT displays, lasers and LEDs, and the high-efficiency outdoor lighting that turns nighttime into a murky orange. The modern system of physical photometry based upon a simple visibility curve is no longer enough, not because of flaws in the curve, but because the human visual system is much more complex than this simple model suggests. Our vision responds nonlinearly to combinations of narrow-band lights, and perceived brightnesses can differ markedly from the predictions of their model. In a sense, it is the same problem that was recognized in the 1920s as the limitation of equality-of-brightness matching. The data told a story which was not understood then, nor of much technological importance. Today, vision researchers are revisiting the issue in an attempt to improve upon the standard model.

Nonetheless, to the extent that we continue to use electronic instruments to observe our surroundings, and to the extent that physical photometry remains the gold

standard around the world for the metrology of lighting, the Gibson and Tyndall curve continues to play an essential role in estimating our perception of light more than 75 years after its introduction.

Kasson S. Gibson received his education at Cornell and joined NBS in 1916. In addition to the work described here, he made important contributions to the design of optical filters for transforming radiation from incandescent lamps to simulate natural daylight. He headed the work on photometry and colorimetry at NBS from 1933 to his retirement in 1955, publishing over 100 papers in spite of his administrative responsibilities. Gibson served as president of the Optical Society of America from 1939 to 1941 and was a Fellow of the American Physical Society, Illuminating Engineering Society, and American Association for the Advancement of Science. He died in 1979 at the age of 89.

Edward P. T. Tyndall worked at NBS in 1917-1919 and later returned for shorter stays as a visiting researcher. He spent most of his career as Professor of Physics at the University of Iowa, where he did important research on the optical and electrical properties of metals. He distinguished himself as a teacher and supervised 74 masters and doctorate students. He also died in 1979 at age 86.

Prepared by Jonathan E. Hardis.

Bibliography

- [1] K. S. Gibson and E. P. T. Tyndall, The Visibility of Radiant Energy, *Sci. Pap. Bur. Stand.* **19**, 131-191 (1923).
- [2] Y. Le Grand, *Light, Colour and Vision*, 2nd ed., translation by R. W. G. Hunt, J. W. T. Walsh, and F. R. W. Hunt, Chapman and Hall Ltd., London (1968).
- [3] P. G. Nutting, The Luminous Equivalent of Radiation, *Bull. Bur. Stand.* **5**, 261-308 (1908).
- [4] W. W. Coblentz and W. B. Emerson, Relative Sensibility of the Average Eye to Light of Different Colors and Some Practical Applications to Radiation Problems, *Bull. Bur. Stand.* **14**, 167-236 (1918).
- [5] P. K. Kaiser, Photopic and Mesopic Photometry: Yesterday, Today and Tomorrow, in *Golden Jubilee of Colour in the CIE*, The Society of Dyers and Colourists, Bradford, UK (1981).
- [6] W. R. Blevin and B. Steiner, Redefinition of the Candela and the Lumen, *Metrologia* **11**, 97-104 (1975).
- [7] D. B. Judd, Reduction of Data on Mixture of Color Stimuli, *Bur. Stand. J. Res.* **4**, 515-548 (1930).
- [8] W. D. Wright, The Historical and Experimental Background to the 1931 CIE System of Colorimetry, in *Golden Jubilee of Colour in the CIE*, The Society of Dyers and Colourists, Bradford, UK (1981).
- [9] D. B. Judd, Report of U. S. Secretariat Committee on Colorimetry and Artificial Daylight, *CIE Proceedings* Vol. 1, Part 7, p. 11 (Stockholm, 1951), Central Bureau of the CIE, Paris. See also G. Wyszecki and W. S. Stiles, *Color Science: Concepts and Methods, Quantitative Data and Formulae*, 2nd ed., John Wiley & Sons, New York (1982) p. 330.

Test of the Severity of Building Fires

From its earliest years, NBS has had international leadership in the measurements, standards, and technologies associated with prevention of human suffering and losses of lives, property, and societal capabilities to unwanted fires. A major milestone in fire safety engineering, internationally, was publication of *Tests of the Severity of Building Fires* [1] in 1928. Its author was Simon H. Ingberg, Chief, Fire Resistance Section, U.S. Bureau of Standards.

Fire statistics published by the National Fire Protection Association [2] show that about two million fires are reported in the United States each year, causing 4000 deaths and 8 billion dollars in property damage. This is bad, but it used to be worse. Early in the 20th century, with a much smaller U.S. population, twice as many people died each year. At that time the fire death rate per 100,000 population was 9.1, in contrast to 1.6 today [2]. The buildings that burned in the early 1900s often collapsed as fire spread throughout the structure. Fire measurement at NBS quantified the intensity and duration of building fires. Simon Ingberg related the measured fire temperatures and duration to equivalent exposure to the standard furnace fire time-temperature curve [3]. Today's fire resistant construction is evaluated using the ASTM E119 standard fire exposure based on the same approach. Ingberg's work provided vital information about the relationship between fire severity as measured in full-scale room and building fire tests and endurance ratings in the standard test method. This provided the guidance for building codes requirements and design approaches for fire resistive construction to contain fire spread in buildings. Today, as a result of confinement, detection, and suppression fire protection strategies, most fires in buildings never grow beyond the room in which the fire started.

In Ingberg's own words:

“One of the main objects of public regulation of building construction is to prevent undue hazard to life and neighboring property from fire. Fire exposure to buildings and building members arises from interior and exterior origins. The evaluation of the exterior exposure can be done with difficulty in quantitative terms, and the gradual accumulation of data from actual fires will probably continue as the main guidance in providing the proper protection. The present paper will deal mainly with methods of gauging the severity of fires resulting from

the burning out of contents of buildings whose wall, floor, and column constructions are fire resistive to such an extent as to be capable of withstanding a complete burning out of building contents without collapse of major details. It is only when the problem is so confined that there is much possibility of obtaining experimentally quantitative information pertinent to the answer sought. The severity of fires completely consuming the combustibles of frame buildings and masonry-walled buildings with combustible interior construction is of interest mainly as it concerns the exposure to adjacent or neighboring buildings and the fire exposure on party and fire walls and on record containers. As it concerns the severity of fires in buildings with interior combustible construction protected with incombustible floor, ceiling and wall finishes, the present discussion will apply up to the limit set by the fire resistance of such protection.

Indications of the intensity of building fires have been obtained from fused metals and from general fire effects on materials on which information is extant as to their reaction to temperature or fire exposure such as in test fires. The fire ruins or reports of fires give, however, little information of the duration of the temperatures in any given portion of the building. The absence of data to enable constructions or devices giving a certain performance in the standard fire test to be applied as protection against fire conditions in buildings with as much precision as results of strength tests are applied for load carrying purposes, led me to consider the possibility of conducting burning-out tests in suitably designed structures to obtain the needed information. If such tests could be made to yield quantitative information on the equivalent fire duration to be expected with given building types and occupancies, it would help measurably to place the whole structure of fire resistance requirements on a rational basis. Fire is a contingent condition that may or may not involve a building or given portion thereof in its lifetime. In theory, at least, the owner should be required to make provision for safety to life within and near the building, and for protection to adjacent and neighboring property only as it concerns the building type and size proposed and the occupancy it is intended to house. With require-

ments more or less uniform for all occupancies the tendency would be to require more than the needed protection for buildings with the lighter occupancies from the fire hazard standpoint, and not enough for those with greater amounts of combustible contents.”

Ingberg addressed these objectives by constructing two single-story fire test buildings on the NBS site of sizes 4.9 by 9.1 meters and 9.1 by 18.3 meters. Various arrangements of furnishing, shelving, and paper (discarded records) were used to assemble realistic representations of offices and records storage rooms (see Fig. 1 and Fig. 2, respectively). Tests included variations,



Fig. 1. The interior of the small test building arranged to represent a typical office with metal furniture on a cement floor. (Used with permission of NFPA.)

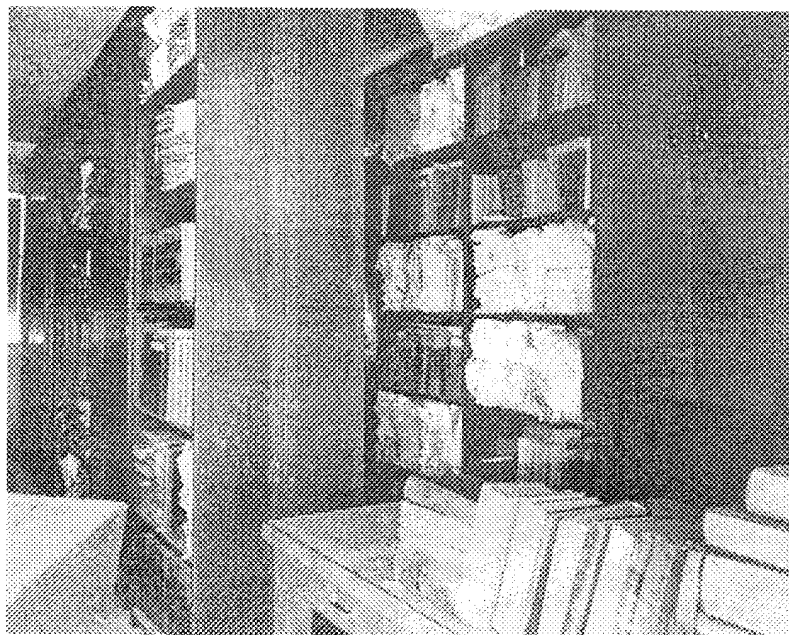

Fig. 2. Steel shelving in the small fire test building arranged to represent a records room. (Used with permission of NFPA.)

such as the use of non-combustible metal furnishings instead of wooden furnishings, to examine the change in fire intensity. Building ventilation was provided to maximize fire conditions by adjusting openings in windows (Fig. 3). Temperatures were measured at 35 to 40 points in the smaller building and 100 in the larger.

Results of ten large-scale tests were analyzed and tabulated to relate the combustible content (in terms of either mass or calorific energy per unit area) to the equivalent fire duration (in hours and minutes) of a standard fire furnace test exposure temperature curve. Except for the fact that average room temperatures in the fire tests generally increased after ignition, then decreased from a peak as fuel was depleted, the two curves were not identical in shape. So the challenge for Ingberg was to adopt a method for gauging the overall severity of a fire test relative to the standard fire exposure. He proposed that the area under the time-temperature curve, but above selected base-line temperatures, represented an approximate gauge of exposure severity. He recognized that this is an approximation, but that no better measure of comparison could be conveniently applied. This remains true today.

Ingberg's tests related severity of fires resulting from a total combustible content (including finished floors and trim) in offices and record rooms ranging from 49 kg/m^2 to 290 kg/m^2 to be the equivalent to standard furnace fire exposures of 1 h to 7.5 h, respectively.

As a result of Ingberg's work, it became possible to develop fire codes and design approaches that related the combustible load in a room, based on its contents and use, to the performance of fire-resistant construction details in the standard fire test.

NBS under Ingberg's leadership continued to explore fire severity, including notable full scale tests in buildings near the corner of 10th and B streets, NW, in downtown Washington, DC, scheduled for demolition to obtain space to construct today's Justice Department Building on the Federal Triangle (Fig. 4). In 1928, this full-scale fire test of buildings ignited, then allowed to burn without application of water, was unique in the history of fire protection engineering. In the test conducted on Sunday morning, June 17, 1928, fire conditions in adjacent five-story and two-story brick open-joint construction buildings were measured for the purpose of comparison to the standard furnace exposure conditions and duration. In addition, the test gathered data about fire exposures to support test standards for fire resistant safes and other record containers.

It remained necessary to provide uniform fire-resistance classifications for building constructions as a sound basis for permitting the use of new systems of construction that could be demonstrated to be comparable in performance to systems prescribed by building codes. A Subcommittee on Fire-Resistance Classifications was organized under the auspices of the U.S.

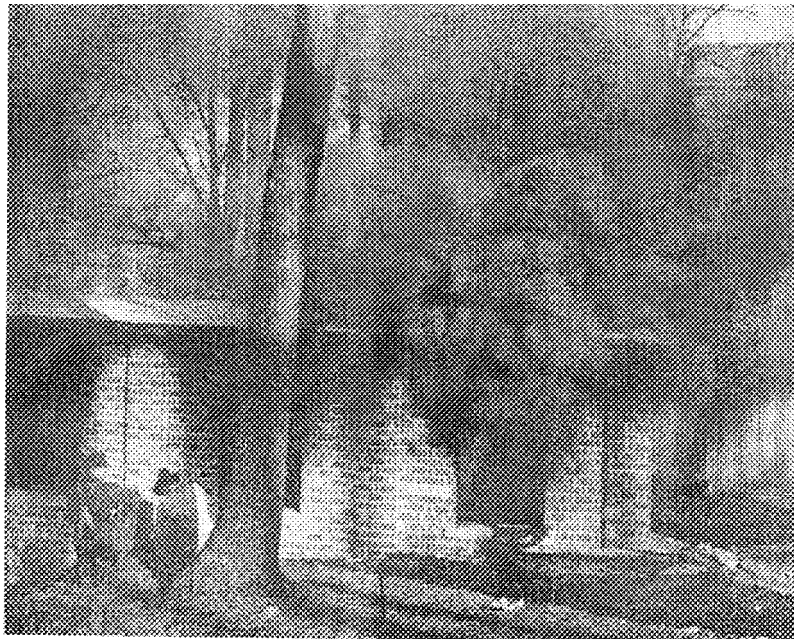

Fig. 3. Smoke billows from small test building on the NBS site through open windows adjusted to control ventilation in one of Ingberg's office occupancy fire test. (Used with permission of NFPA.)



Fig. 4. Burning test buildings near the corner of 10th and B Streets, NW, in Washington 10 to 20 minutes after ignition on Sunday morning, June 17, 1928. These burning buildings are on the present day site of the Justice Department Building. The Old Post Office building is in the background. (Used with permission of NFPA.)

Government's Central Housing Committee on Research, Design, and Construction. Subcommittee members were officials of federal agencies including Public Buildings Administration, Federal Housing Administration, United States Housing Authority, and Home Owners' Loan Corporation. Ingberg served as technical advisor to the subcommittee, led the program of research, and wrote its seminal report, *Fire Resistance Classifi-*

cations of Building Constructions [4] in 1942. The report contained:

1. A classification of four types of construction (Fireproof, Incombustible, Exterior-Protected, and Wood) covering the whole range of basic building construction properties that influence fire hazard.

2. Estimations of fire severity based on surveys of combustible contents of buildings housing typical occupancies.
3. Fire-resistance ratings of building constructions and fire-resistance classifications of roofing materials derived from analyses of test results at NBS and other laboratories.

Ingberg's work on fire severity and fire resistance was adopted by national standards and model building codes, which in turn became the bases for the legal building codes of local and state governments throughout the U.S. His principles and recommendations remain the basis for today's standards and building codes for determining the effects of combustible building contents and furnishings on the severity of fires for which buildings are required to be designed. His classifications of building types remain the basis for requirements for fire resistance of building components such as walls, floors, roofs, doors, and windows.

Simon Ingberg was born in Ringsaker, Norway on June 24, 1877, emigrated to the United States with his parents in 1881, and grew up on a farm near Hendrum, Minnesota [5]. After finishing his junior year in high school, he taught in the public schools of Norman and Polk counties, Minnesota, for ten years prior to going to college. He received a B.S. in civil engineering from the University of Minnesota in 1909, and an M.S. in theoretical and applied mechanics from the University of Illinois in 1910. After 1 year on the faculty of Lehigh University, and work with a Chicago structural engineering firm, he joined NBS in 1914 as an associate physicist. His first assignment was to oversee fire tests sponsored by NBS at Underwriters' Laboratories in Chicago.

In 1915 Ingberg was placed in charge of a new fire resistance section in the Heat Division of NBS, and he traveled extensively for six years to oversee fire testing in Chicago and in NBS laboratories in Pittsburgh and Washington. These included studies of concrete and steel columns and development of a furnace for studying the fire resistance of wall panels. During the 1920s and 1930s, his studies included fire protection of steel columns; strength of brick masonry; influence of the mineral content of concrete on fire performance; strength of steel, iron, and wood at high temperatures; self-heating and ignition of agricultural products; test of

carbon dioxide for fire control in buildings; fire hazards of vaults for nitrocellulose film; cigarette ignition of mattresses; the cigarette as a fire hazard; flame spread test methods; performance of fire detection devices; surveys of fire loads in buildings; severity of building fires; chimney fires; and theater proscenium curtains. Federal funds were limited, and only with industry support was it possible to conduct much of the fire resistance work.

Ingberg was told he had to retire in 1947 shortly before his 70th birthday. He did not stop work, but made his garage into a fire test facility, and continued to prepare papers with NBS colleagues as a guest researcher. From 1954 to 1969, he was employed as a consultant to Rohm and Haas Company, which was promoting the use of plastics in buildings. A part of his advice was the recommendation: "You should so conduct yourselves that when your products are involved in a disastrous fire, and they certainly will be, that there is nothing in the occurrence for which you must apologize." In 1963 ASTM gave Ingberg its Award of Merit, and in 1970 ASTM Committee E-5 on Fire Standards established the Simon Ingberg Award to recognize those who have continued outstanding accomplishments, like his, in advancing fire safety.

Prepared by David Evans, Daniel Gross, and Richard Wright

Bibliography

- [1] S. H. Ingberg, Tests of the Severity of Building Fires, *Q. Natl. Fire Prot. Assoc.* **22**, 43-61 (1928).
- [2] John R. Hall, Jr. and Arthur E. Cote, America's Fire Problem and Fire Protection, in *Fire Protection Handbook, Eighteenth Edition*, Arthur E. Cote, (ed.), National Fire Protection Association, Quincy, Massachusetts (1997).
- [3] *Standard Test Methods for Fire Tests of Building Construction and Materials*, ASTM E-119, 1997 Annual Book of ASTM Standards, Section 4 Construction, Volume 04.07 Building Seals and Sealants; Fire Standards; Dimension Stone, American Society for Testing and Materials, West Conshohocken, PA (1997) pp. 441-461.
- [4] John W. Dunham, William J. O'Connor, S.H. Ingberg, Bert M. Thorud, and Charles N. Diener, *Fire-Resistance Classifications of Building Constructions*, Building Materials and Structures Report BMS92, National Bureau of Standards, Washington, DC (1942).
- [5] Alexander F. Robertson, Simon H. Ingberg—Pioneer in Fire Research, *ASTM Stand. News* **13** (2), 50-53 (1985).

Calculation of Compounds in Portland Cements

The National Bureau of Standards–National Institutes of Standards and Technology has had an illustrious history of research on the most widely-used, man-made materials of construction, cement and concrete—materials which are often taken for granted, because of their commodity nature and generally successful use in the structures that comprise about 80 % of the Nation’s fixed wealth. The level of NBS–NIST’s cement and concrete materials research effort, in contrast to its structural research effort, has varied substantially over the century, with two highly productive periods separated by an almost dormant period from about 1960 to 1980. While some important contributions were certainly made prior to 1924, an outstanding period stretched from 1924 to 1954 when a strong NIST cement research program was complemented by an equally strong and synergistic industry-supported program, the Portland Cement Association Fellowship at the National Bureau of Standards. The Director of the PCA Fellowship for the whole of its 30-year life was Dr. Robert Bogue, a major figure in the history of cement research.

Robert Herman Bogue, a physical chemist, was born in Southborough, Massachusetts, on September 27, 1889. Before taking the position as Director of the PCA Fellowship in 1924, he had obtained degrees from Tufts University (B.S., 1912), Massachusetts College (M.S., 1915), and the University of Pittsburgh (Ph.D., 1920), and had gained professional experience as an Assistant Professor at Montana State College, 1915-17, a Fellow of the Mellon Institute, 1917-22, and an Associate Professor at Lafayette College, 1922-24. His research interests at that time appear to have been the chemistry of gelatine and the colloidal behavior of proteins—subjects remote from the inorganic materials that would be central to the rest of his professional career.

As Director of the PCA Fellowship, Bogue exercised a remarkably far-sighted leadership that made the Fellowship a major contributor to what would now be described as the materials science of concrete. Among Bogue’s personal contributions was a landmark paper, *Calculation of Compounds in Portland Cement* [1], published in 1929. To understand the significance of the paper, it is necessary to know a little about portland cement and its manufacture.

Portland cement was invented in 1824. Its essential ingredient is cement clinker, a granular product from the high temperature (~1500 °C) processing of an appropriately proportioned, finely-ground mixture of minerals that are sources of the common oxides CaO, SiO₂, Al₂O₃, and Fe₂O₃; (for convenience in this paper, and in accord with cement industry usage, these oxides will frequently be referred to by the single letters C, S, A and F, respectively). Typical raw materials that are sources of these oxides in clinker production are, in the same order, limestone, quartz sand, clay, and iron ore. The cement manufacture ends with the intergrinding of clinker with a mass fraction of about 5 % gypsum (CaSO₄ · 2H₂O) to produce the fine cement powder, usually gray in color, of which almost 100 million tonnes (1 tonne = 1000 kg) are produced in the U.S. each year. (The gypsum is added to control the rate of setting of the cement.)

Until the publication of Bogue’s paper, there was much controversy about the compositions of the compounds present in the clinker, even though the elemental compositions of clinker and cement (always expressed in terms of simple oxides) were determined routinely in cement plants and other laboratories. Publication of the paper obviously met an objective Bogue had set for the Fellowship since, in the text of an address given to the American Concrete Institute [2] two years earlier in 1927, he wrote: “. . . this is an age of advancement. The cry for new knowledge is in the air. . . . Questions are being asked now in all seriousness which a few years ago would have been regarded as absurd because unanswerable. . . . All of this brings us to the belief that an unraveling of the laws governing the constitution of cement clinker and the behavior of the constituents of cement when made into concrete may hold developments which today can only be sensed but not definitely apprehended.” In the same address, he made the nature of the problem to be solved clear by saying, “Of fundamental importance, above all others, and for the reasons given above, are the studies which will give us information of the nature of the constituents in clinker. Some of these have been known for some time. Others have been guessed at, but the guesses of the various authorities do not always agree. One group believes that a complex compound containing lime,

alumina, and silica is present in clinker; another group, that lime and one of the silicates form a loosely bound compound known as a solid solution; and still another group, that the lime and silica form two separate silicates. . . . But other components than lime and silica are present, and we must learn the manner of their combination. Into what compounds do the alumina, iron oxide, and magnesia go? What change is observed in the composition of the product resulting from the use of different percentages of these and still other constituents of the raw material?"

From petrographic studies, Bogue knew that portland cement clinker usually contained four main compounds (referred to as alite, belite, celite and felite) of unknown composition (Fig. 1), but there was, as yet, no practical way of determining their quantities. From the growing, but still incomplete, knowledge of the phase relationships in the $\text{CaO-SiO}_2\text{-Al}_2\text{O}_3\text{-Fe}_2\text{O}_3$ (or C-S-A-F) system, Bogue concluded that the main compounds in clinker were tricalcium silicate (Ca_3SiO_5 or C_3S), dicalcium silicate (Ca_2SiO_4 or C_2S), tricalcium aluminate ($\text{Ca}_3\text{Al}_2\text{O}_6$ or C_3A), and tetracalcium aluminoferrite ($\text{Ca}_4\text{Al}_2\text{Fe}_2\text{O}_{10}$ or C_4AF), and that the quantities of each could be calculated from the oxide composition of the clinker, provided the high temperature reactions had gone to completion in producing the equilibrium products and no significant amount of unreacted material remained. On this basis, at least to a useful approximation, Bogue was successful in unraveling "the laws governing the constitution of cement clinker" and he presented a set of simultaneous equations, together with nomographs, for calculating the amounts of the major compounds—the "potential compound composition"—of a clinker or a portland cement from the results of analyses for the major oxides (CaO , SiO_2 , Al_2O_3 , and Fe_2O_3) together with determinations of MgO , loss on ignition, and acid-insoluble residue. He realized that the compounds were unlikely to be pure because of the presence of unwanted minor oxides in the raw materials, but he did not have data that would enable him to take the minor oxides into account in his calculations. In spite of this limitation, Bogue believed that the calculated amounts of the compounds were close enough to reality to be useful. That this is true is amply demonstrated by the fact that Bogue's equations became, and 70 years later still remain, the basis for the classification scheme used in the ASTM C-150 specification for portland cement.

Ability to calculate compositions of cements in terms of the amounts of the main compounds present provided a valuable new tool for explaining, or predicting, differences in engineering performance among portland cements. This was true even though, when he wrote his paper, Bogue did not know that the composition of the

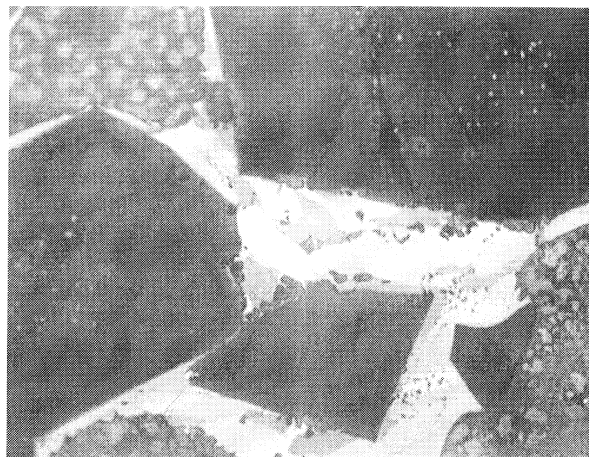

Fig. 1. Polished and etched section of portland cement clinker showing evidence of four major compounds (phases) such as would have been seen by Bogue (courtesy of Paul Stutzman).

aluminoferrite phase could vary much more than the compositions of the other major compounds; the "C₄AF" phase is, in fact, a member of a solid solution series of which the end members are $\text{Ca}_6\text{Al}_4\text{Fe}_2\text{O}_{15}$ and $\text{Ca}_2\text{Fe}_2\text{O}_5$ (or $\text{C}_6\text{A}_2\text{F}$ and C_2F); however, for most portland cements, the composition of the aluminoferrite phase is reasonably close to the composition assumed by Bogue.

The ability to calculate the amounts of the major compounds in a clinker or cement had important implications. There was now the possibility of studying relationships between the amounts of the compounds in a cement and the cement's engineering performance in concrete, especially in relation to "durability." Beginning in 1940, this led to the inclusion of the Bogue equations in the ASTM specification for portland cements, because it was then certain that the amounts of the major compounds was one of the factors that determined engineering performance. The ASTM Type of a portland cement (I, II, III, IV or V) [3] is still determined, at least in part, by its "potential compound composition," colloquially referred to as its "Bogue composition." Thus, an ASTM Type IV Portland Cement is a "low heat cement," required to be low in C_3S and low in C_3A ; it was developed for use in massive concrete structures, specifically for construction of the Hoover Dam. An ASTM Type V Portland Cement is a "sulfate-resistant cement," which is required to contain a maximum of 5 % by mass of C_3A ; it was developed for use in concrete that will be in contact with sulfate-rich soils or waters; and an ASTM Type II Portland Cement (containing a maximum of 8 % by mass of C_3A) is both a "moderate heat" and a "moderately sulfate resistant" cement. There is no need to explain to a cement chemist, whether in the

United States or in many other countries, what is meant when the “Bogue composition” is referred to.

Bogue’s legacy from his years as Director of the PCA Fellowship is reflected not only in his technique for calculating phase compositions of cements but also in many experimental studies, often carried out with his participation, of phase relationships in systems relevant to cement and concrete. Representing H_2O , K_2O , and Na_2O by H, K and N, respectively, some of the systems studied were of the anhydrous systems: C-A-S, C-N-A, C-M-C₂S-C₅A₃, C₂S-KCS, N-C-A-S, and C-CA-C₂F; and the hydrous systems studied included: C-S-H, the garnet-hydrogarnet system, C-A-H, C-N-S-H, and hydrogarnet in C-A-S-H. Bogue was clearly one of the more eminent cement chemists of his day, and his scholarly text, *The Chemistry of Portland Cements* [4], remained the single most comprehensive and authoritative source of knowledge of cement chemistry from the time of its first publication at least until the mid-70s.

It was probably a coincidence that, in 1929, the year Bogue’s paper was published, the NBS Director responded to a Congressional request to set up a program to ensure that cements used in federal construction projects be of the required quality. This began as an NBS-managed and operated program which, over several years, evolved into a partnership with ASTM as the Cement Reference Laboratory (CRL). The CRL evolved further and enlarged its scope to include concrete, becoming what is now the ASTM-sponsored Cement and Concrete Reference Laboratory (CCRL). In its present form, the CCRL is a research associateship which, through laboratory inspection and proficiency sample programs, provides quality assurance to testing laboratories that use ASTM standards, including ASTM C-150 with its Bogue calculations, in the testing of cement and concrete. An important development made to improve the efficiency of the CCRL proficiency sample program was described in the 1959 paper, “Statistical Aspects of the Cement Testing Program” [5] by the renowned NBS statistician, W. J. Youden. Youden showed how the amount of information obtainable from an interlaboratory test program could be increased substantially by issuing proficiency samples in pairs—a procedure which is widely used both nationally and internationally.

While Bogue’s paper gave new insight into the amounts of the major compounds in portland cements, it did not provide any clue as to how the compounds might be distributed within and among individual cement particles. Indeed, in spite of the fact that particle size distribution and fineness are important characteristics which affect the performance of cements, there were no useful ASTM standard methods for their determination until the sedimentation method for determination of

particle size distribution was adopted in 1933 and the air permeability method for determination of fineness was adopted in 1943. Both methods are still commonly known by the names of the NBS researchers who developed them, Wagner and Blaine, respectively. Attainment of the capability to determine the distribution of the cement compounds within cement particles was long delayed. It was not until 1997 that another researcher at NIST, Dale Bentz, showed its importance (Fig. 2) in accounting for differences among cements [6]. In Bogue’s day, this might have been viewed as an attempt to answer one of those questions that “would have been considered absurd because unanswerable.”

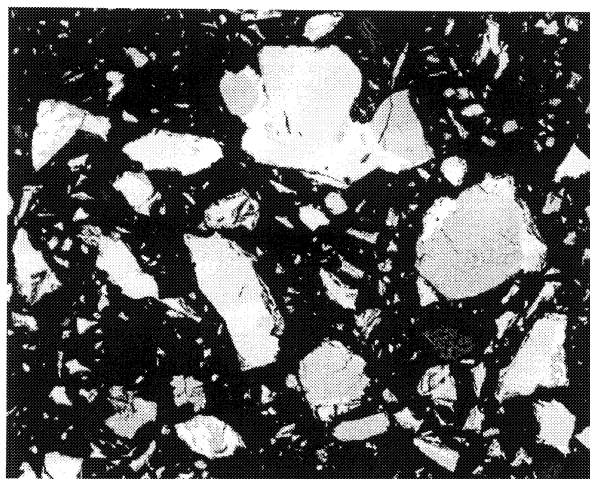

Fig. 2. Modern technology: Backscattered electron image of a polished section of portland cement particles from CCRL Proficiency Sample No.115 embedded in an epoxy resin. The major portland cement clinker phases in the cement particles can be identified, with reasonable confidence, by their grey levels in the image and the habits of the crystals. More definitive information about the distribution of the cement phases within and among the particles can be obtained using x-ray imaging to apply false color based on the elemental compositions of the individual crystals. (Micrograph courtesy of Paul Stutzman).

As mentioned earlier, NBS research into the materials science of cement and concrete fell to a low level between 1960 and 1980. Then in 1981, in response to the national need for research on cement and concrete made apparent by the Nation’s failing civil engineering infrastructure, NBS established a cement hydration competence project. The complexity of cement chemistry and of the physical and mechanical changes accompanying the cement hydration reactions suggested that computer simulation should be an important part of the program. In 1986, a paper by Hamlin Jennings and Steven Johnson of NBS, *Simulation of Microstructure*

Development During the Hydration of a Cement Compound [7], received the Best Paper Award from the Cements Division of the American Ceramic Society and was featured on the cover of the magazine Science News. This was the beginning of a program which has made NIST the world leader in the computational materials science of concrete and other cement-based materials. The series of publications has progressed from simulations of the 3-dimensional random porous structures formed in hardening cement pastes to calculations of the diffusivities and elastic moduli of the structures; to the rates of reaction and heat evolution during the hardening of cement pastes taking into account the experimentally-determined phase composition (which is not dependent on Bogue's calculation method) and phase distribution; to the effects on diffusivity of concrete attributable to the aggregates imbedded in the hardened cement paste and the interfacial zones around them; to calculations of the service life of chloride-exposed, steel-reinforced concrete, to the rheological properties of concentrated dispersions

of irregularly-shaped particles with predictions of the effects of interparticle forces; to the effects of embedded electrically-conducting fibers on the electrical properties of mortars; to the effect of randomly-distributed thermoplastic fibers on the fire resistance of high-strength concrete; and to the moisture distribution in concrete under a variety of curing conditions and its effect on shrinkage. Together, these developments illustrate the concept of virtual cement and concrete in which the properties of concrete mixtures made from as-yet-unavailable hypothetical materials might be predicted, thereby providing a powerful new tool for product development. As papers on the simulation models are approved for publication, they are added to the web-based *Electronic monograph on the computational materials science of concrete* [8] initiated by Edward Garboczi and Dale Bentz in 1996, more recently joined in the venture by Kenneth Snyder, Nicos Martys, and Chiara Ferraris. The continually-evolving monograph (Fig. 3) is a repository for NIST's contributions to the computational materials science of concrete

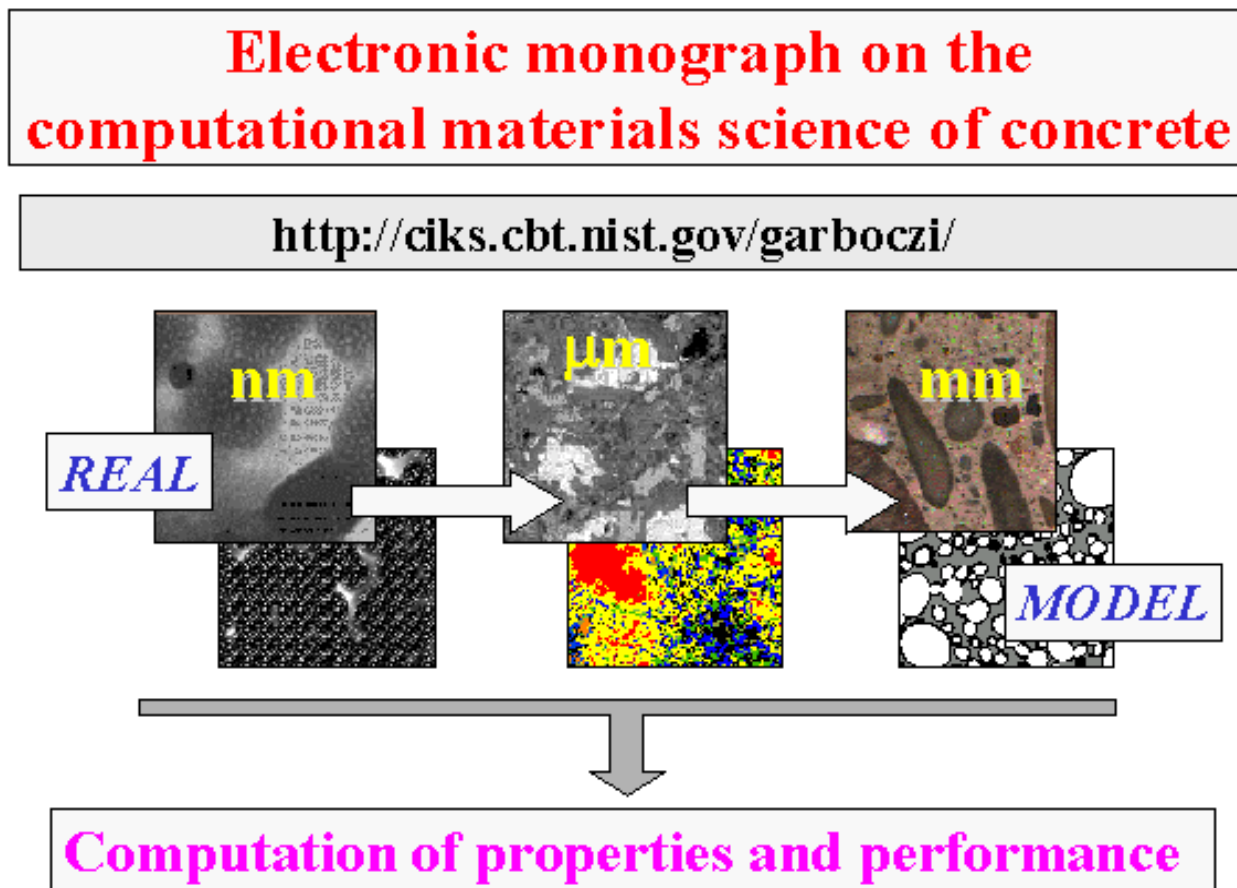

Fig. 3. Announcing the web-based “*Electronic monograph on the computational materials science of concrete*”—equivalent to about 1500 printed pages of NIST models for predicting the structure and properties of cement and concrete, and growing by several hundred pages each year.

through which they are made available to the world. The monograph has now reached the equivalent of 1500 printed pages in length and continues to grow. In a typical month, the monograph's web-site is accessed by more than 1000 persons from about 40 countries.

The advances in computational materials science of concrete have been complemented by advances in techniques for cement characterization, particularly in electron micrographic petrography, and application of quantitative x-ray diffraction analysis. NIST research in both areas has led to new ASTM standards, and both techniques have been applied to characterization of a suite of three portland cement clinkers which have been designated NIST Reference Materials.

From his writings, one feels that Bogue would have appreciated the recent work at NIST because it seems to be in complete philosophical accord with his views and because it has benefitted so much from the program he led from 1924 to 1954. For example, early in the life of the PCA Fellowship, Bogue commented, "Just in what department our investigations will prove to be of greatest value, we do not know, but we are convinced that scientific information on the nature of the compounds of clinker and of the reactions of these compounds, holds promise of application in many directions. Perhaps the eventual direct application may be in manufacture, in raw material, in control, or it may be in the utilization of cement in concrete. . . . This is one of our ambitions; one of the reasons for our existence. The other is to extend the field of usefulness of concrete by the development of a material which will possess to a higher degree the virtuous qualities for which concrete is now well known. Or, perhaps, even go beyond these to the opening up of new possibilities

in construction, or art, or industry which are not yet conceived. In the case of many commodities, supply follows the demand, but in the case of the new discoveries of science, a market is born where none existed and the creation of the product opens to reality trails of progress, of achievement, which formerly were lighted only by the Aladdin's Lamp of Imagination." The range of impacts of Bogue's work illustrates the correctness of his vision.

Prepared by Geoffrey Frohnsdorff.

Bibliography

- [1] Robert H. Bogue, Calculation of the Compounds in Portland Cement, *Ind. Eng. Chem., Anal. Ed.* **1**, 192-197 (1929).
- [2] Robert H. Bogue, Portland Cement in Concrete Engineering, *Concrete*, **30** (3), 33-36 (1927).
- [3] *Standard Specification for Portland Cement*, ASTM C-150, Annual Book of ASTM Standards, Vol. 04.01, Cement, Lime and Gypsum, American Society for Testing and Materials, West Conshohocken, PA (1999).
- [4] Robert H. Bogue, *The Chemistry of Portland Cement*, Reinhold Publishing Co., New York (1947).
- [5] W. J. Youden, Statistical Aspects of the Cement Testing Program, *Proc. Am. Soc. Test. Mater.* **59**, 1120-1128 (1959).
- [6] Dale P. Bentz, Three-Dimensional Computer Simulation of Portland Cement Hydration and Microstructure Development, *J. Am. Ceram. Soc.* **80**, 3-21 (1997).
- [7] Hamlin M. Jennings and Steven K. Johnson, Simulation of Microstructure Development During the Hydration of a Cement Compound, *J. Am. Ceram. Soc.* **69**, 790-795 (1986).
- [8] Edward J. Garboczi, Dale P. Bentz, Kenneth A. Snyder, Nicos S. Martys, Paul E. Stutzman, and Chiara F. Ferraris, *An electronic monograph: Modelling and Measuring the Structure and Properties of Cement-based Materials*, (<http://ciks.cbt.nist.gov/garboczi/>), National Institute of Standards and Technology.

Development of the Visual-Type Airway Radio-Beacon System

The object of the research reported in this paper was to provide a system of navigational aids by which aircraft could be flown on a course in fog or in any condition of visibility or no visibility. After World War I civil aviation had become a serious enterprise with mail, express, and passenger flights. Weather and conditions of visibility hampered regular schedules that had now become highly desirable for the new industry to be commercially successful. The requirements of airmail service necessitated night flying to meet the “next day” delivery schedules the Post Office wanted to establish across the nation. This research paper [1] summarizes the work done at the Bureau of Standards between 1926 and 1929 for the purpose of making possible blind flying and landing of aircraft.

Navigational instruments available at that time were the altimeter, the bank-and-turn indicator, the rate-of-climb indicator, and the compass. With these instruments it was possible to continue to fly in fog, but it was only by radio means that the pilot could be certain of staying on course and finding the landing field when the ground was invisible. Accurate as a compass may be, it cannot tell the pilot that the aircraft has drifted off course. The altimeter (simply a barometer) gives only an approximation of the height above ground and cannot warn of obstacles in the flight path.

The Bureau of Standards began work on radio navigation for the military during World War I. Since military aircraft did not fly on fixed airways, they required direction-determination service on independent courses. The radio direction finder, using loop antennae and sensitive receiving sets aboard airplanes, was chosen as a homing device well adapted to military needs. However, the method was not useful for nonmilitary aviation because great difficulties were experienced with this type of receiving apparatus. There were two reasons for non-acceptance by civilian aircraft: the expense and weight of the receiving equipment, and the inherent slowness and complexity of operating the radio direction finder. Although the direction finder could not tell when wind drift had shifted the aircraft off-course, the method eventually brought the aircraft home to its destination, often by a circuitous route.

A new method was developed with the direction finder based on the ground. Every plane in commercial transport service carried a radiotelephone transmitter and receiver, used with a trailing-wire antenna. Perma-

nent direction-finding stations were located at certain principal airports. For an aircraft to find its position, it transmitted a radio request to the airport, whereupon two or more direction-finding stations each observed the radio waves transmitted by the airplane; triangulation yielded the airplane’s position, which was then transmitted to the pilot. But this system required an airplane to carry both receiving and transmitting equipment, and it was not effective when a large number of airplanes simultaneously requested position coordinates since the ground station could serve only one plane at a time.

The Bureau’s first crude radio guidance system for aircraft was tested in 1921 when a pilot flew along a course designated by signals from two transmitters on the ground. A prototype radiobeacon produced two years later by the Bureau for the Army Air Service was put aside in favor of further work on the radio compass. Without passengers, flying the mail was considered “high adventure,” and the pilots liked it that way. Thus the prevailing attitude of pilots discouraged further refinements of navigational systems, and work on the beacon did not resume until 1926.

The radiobeacon system described in this paper was an outgrowth of the project undertaken by the Bureau of Standards for the Army Air Service in 1920. The Air Service had requested the Bureau to devise a method whereby a directional transmission would serve as a guide to airplanes along a chosen course. Army Air Corps engineers added further refinements to the Bureau prototype. In July of 1926 the Department of Commerce decided to establish an Aeronautics Branch, which requested its research division at the Bureau of Standards to carry out necessary experimentation and development to provide civilian aircraft with navigational aids. The work over the next three years led to very major improvements, the results of which are reported in this paper.

In order to engage in blind flying and blind landing—that is, flying under conditions of no visibility—the pilot must know the position in three dimensions at all times. This can be achieved with indicators on the aircraft instrument panel that record the signals from a small direction beacon, giving the pilot the longitudinal or approach position, plus an inclined ultrahigh frequency radio beam that continuously reports the height above ground. For such a scheme to work, an important

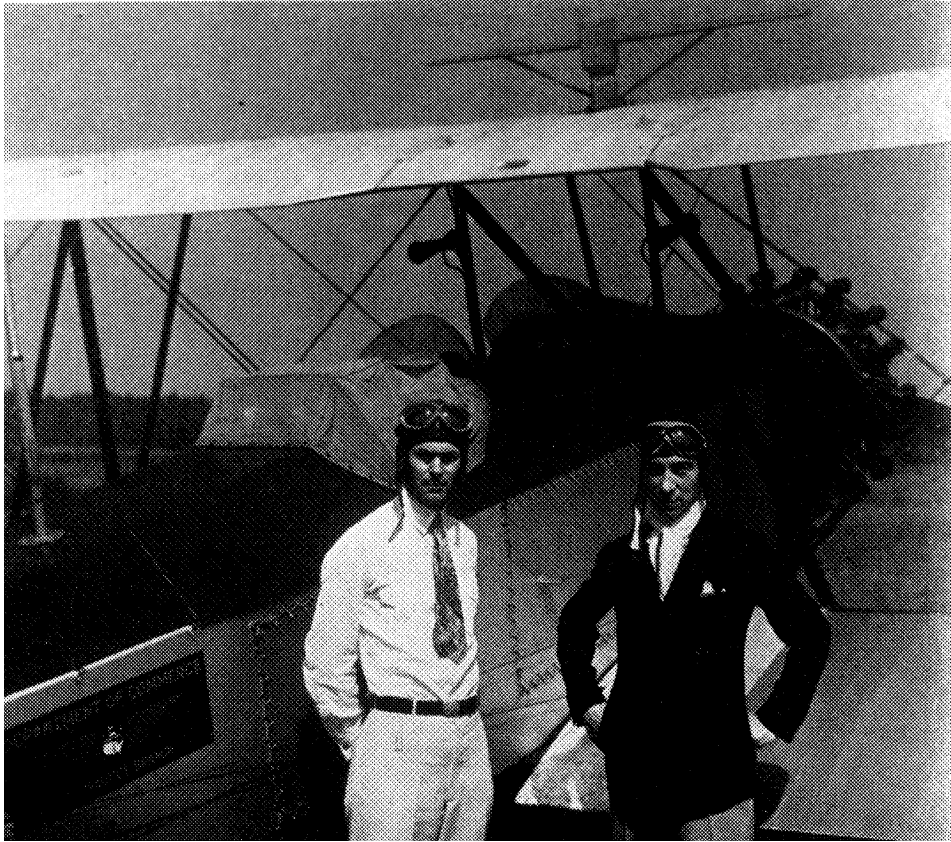

Fig.1. The early blind landing experiments conducted at College Park, MD, used a plane with a canvas hood over the pilot's seat. The copilot took over if plans went awry (from Ref. 3).

difficulty still remained because the Commerce Department transmitted weather information to planes on a different frequency. This meant that the pilot had to keep switching frequencies and also contend with interference from marine radios. Adding a device allowing voice communication about weather conditions without interruption to the range service (radiobeacon) solved the difficulty. It was fortuitous that the inventive talents of Harry Diamond and his team made possible the assembly of the first visual-type radiobeacon system that enabled a pilot to keep on course and to know his approximate position at all times while in flight.

In the paper on the assembly of the visual-type radiobeacon system, the authors describe the property that "direction service could be given to any number of planes flying the course, and that each airplane only had to carry a receiving set, with no other special equipment whatsoever. The pilot would obtain the necessary information pertaining to magnitude of course deviations hands-free and without having to rely on earphones. The means to accomplish this was the development of vibrating-reed indicators that alerted the pilot to any off-course condition. The system had to

be also entirely free from errors due to wind drift. Finally, all heavy radio equipment would have to be on the ground, the receiving set on the plane to be light of weight and simple."

In 1919, Francis Dunmore and F.H. Engel [2] had already developed a radiobeacon system that mapped out "highways" that a pilot could follow by listening to the signal pattern on a radio receiver. But the landing of an aircraft after arrival at an airport is three-dimensional, as shown in Fig. 2. The pilot must have lateral guidance to stay within the confines of the runway during the approach to the field, and the pilot must also have longitudinal guidance in the approach to the landing field in order to know the distance from the landing point. Finally, the pilot must have vertical guidance to decrease the altitude gradually as the plane glides towards the field.

A major step forward came with the replacement of the voice communication system (radiotelephone) by a visual indicator in the cockpit. The means to accomplish this was a set of tuned reeds that would tell the pilot by how much he was off course and whether to steer left or right to get back on the right course. A test of

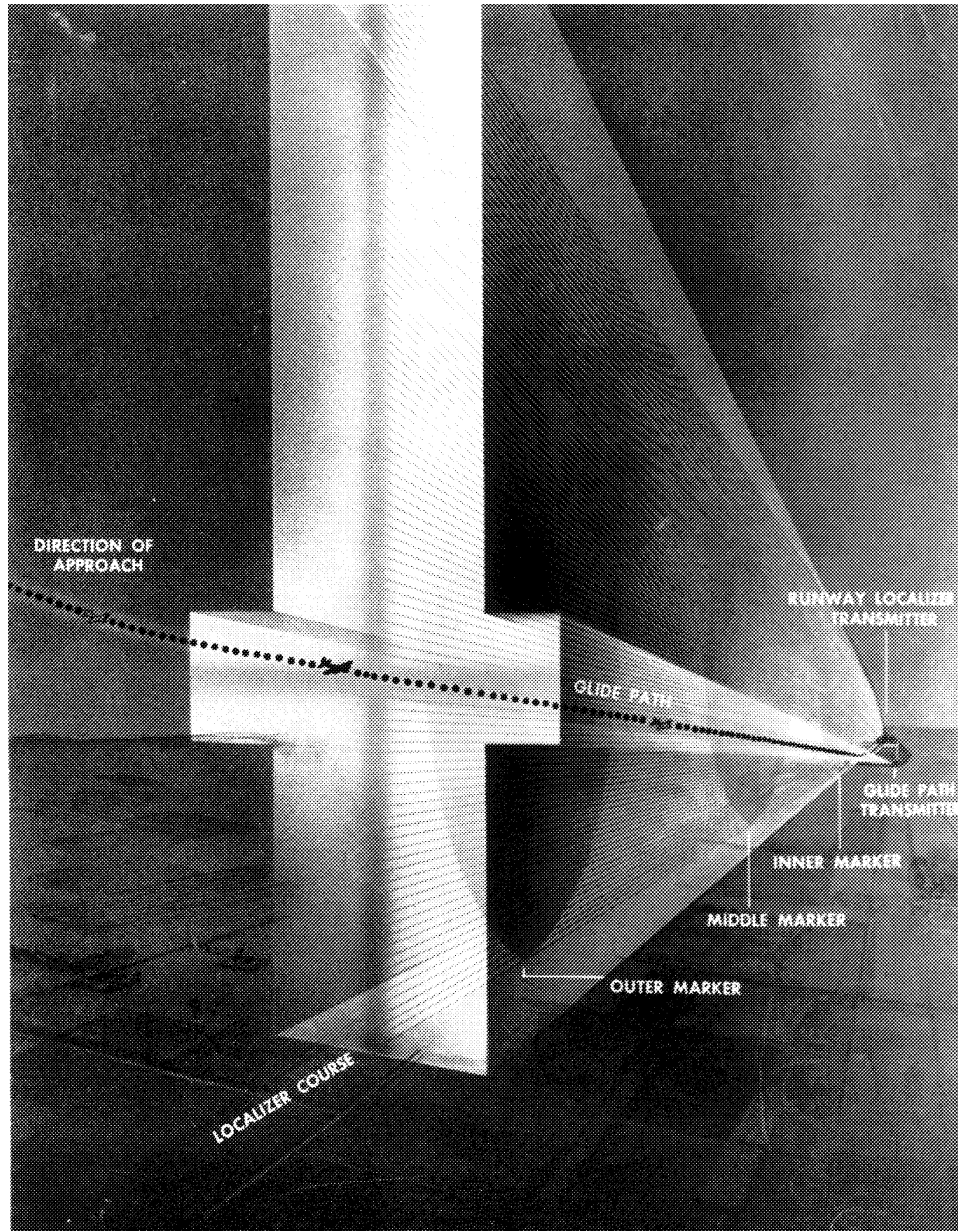

Fig. 2. Definition of the glide path consists of a localizer course for lateral guidance, an outer and middle marker to tell the pilot the *distance to the runway*, and a glide path (UHF) transmitter for the *vertical guidance* (from Ref. [3]).

the *direction finder system* came in 1929 when a pilot took off from Philadelphia on a day of low visibility and was told to fly to College Park, Maryland—120 miles away. The pilot, unfamiliar with the route or the landmarks and with no maps, had to follow solely the guidance given by the beacon indicator on the instrument board. He not only flew in a straight line to Washington, but when over the College Park field, the location of which he did not know, the sudden drop in the reed deflections signaled that he was at the journey's end, and he completed the flight with a visual landing.

However, a pilot needed more precise longitudinal guidance in order to prepare for a blind landing. For that purpose, Diamond and Dunmore devised a “distance indicator” instrument for the airplane based on measuring the field strength of the incoming radio signal. The instrument would calibrate itself by two marker beacons, one located about 2000 feet from the runway and the other at the edge of the runway. The authors describe in great detail various systems and techniques that would meet these requirements: the receiving equipment they developed for use on board the aircraft,

the marker beacons that inform the pilot when passing over one of the locations, and considerations for fog landings.

The next phase of the problem—providing vertical guidance for the pilot in the descent for landing—was solved by another transmitter antenna located near the runway localizer transmitter. Using ultra-high frequencies this time, the second antenna would send out a radio wave pattern, parabolic in shape and sharply enough defined to form an invisible ramp that the pilot would follow as the plane glided down to earth. (This was probably the very first practical use of ultra-high radio frequencies).

In 1930 Diamond added a 15-pound unit to the radio range beacon and radiotelephone in the cockpit that made possible the first blind landing of an airplane entirely by radio guidance [4]. The test came on September 5, 1931, when an airplane, on loan from the Bureau of Air Commerce with pilot Marshall S. Boggs at the controls, made the first blind landing in the history of aviation using only radio signals for lateral, longitudinal, and horizontal guidance. (A previous blind landing had been accomplished in July 1929 when Lt. James Doolittle brought down a hooded plane using a sensitive barometric altimeter and a gyro-stabilized horizon indicator, together with a radio lateral course indicator and marker beacon, also supplied by the Bureau.) This blind-landing system was turned over to the Department of Commerce in 1933.

Diamond and Dunmore admitted that, for a time in 1933, they thought that they had sold the system to the Commerce Department for adoption. They believed it was inherently simple and practicable and could be mastered by a pilot in five hours of practice. Their hopes for adoption were not fulfilled until the beginning of World War II.

After 1933, the U.S. Civil Aeronautics Administration (CAA) continued to experiment with other systems. The difficulty remained with the definition of the glide path. The Lorenz A.G. of Germany in 1934 announced a blind landing system similar to that of Diamond and Dunmore, but that system failed to provide a smooth glide path and hence fell short of adoption there. France became the first nation to adopt the Diamond-Dunmore system in 1935.

In 1937, a U.S. committee proposed the standardization of the best features of all systems that had been tested up to that time. Indianapolis was to be the test site, but satisfactory results did not come until Diamond's ultra-high-frequency antenna system was employed to obtain a straight "equi-signal" glide path. Diamond and Dunmore also improved the stability and sharpness of the runway localizer course and suggested further improvements in equipment and instrumentation. In 1939 a committee of the National Academy of Sciences, meeting at the request of the President, recommended the adoption of the system, called "Indianapolis" and later the "CAA Instrument Landing System (ILS)." Installation of ten such systems at key airports began.

However, World War II stopped the commercial development of blind landing systems and the armed forces took over the ILS, labeling it "SCS-51." It was used by the Allies throughout the war and was put to a crucial test during the Berlin airlift from June 1948 to September 1949. But even before that, in 1946, the CAA began installing the ILS on a wide scale for commercial use throughout the United States.

Now, 60 years later, the principles of this blind landing system are still the basis for air traffic control systems worldwide. The introduction of the global positioning system (GPS) was a major technological innovation able to guide airplanes across the vast oceans

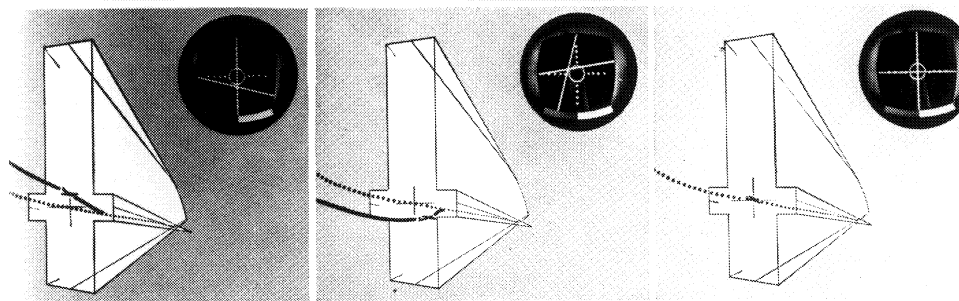

Fig. 3. By watching the pointers on the combined instrument, the pilot follows the glide path and runway localizer course to a safe landing. LEFT: He is on the runway course but above the glide path. CENTER: He is below the glide path and to the right of the runway. RIGHT: He is "on the beam." (From Ref. 3)

which were previously inaccessible to standard radio-navigation methods, thereby closing some big “black holes” in global air traffic control. Furthermore, radar provides the means to control the movement in the vicinity of most major airports today. Summary reports about this phase of NBS Research appear in [5] and [6].

Francis W. Dunmore and Harry Diamond were both born and raised in the vicinity of Boston. Dunmore got his degree in physics from Penn State in 1915, while the younger Diamond graduated from M. I. T. with a degree in electrical engineering in 1922. He worked for General Electric and B.F. Sturtevant Companies in Boston, taught electrical engineering and picked up another degree from Lehigh University. Diamond came to the Bureau of Standards’ radio laboratory in 1927, not long after it was handed the responsibility for the research and development work of the Commerce Department’s newly organized Bureau of Air Commerce. Diamond would soon become the chief of the Aeronautics Branch there. Prior to World War II, Diamond, Dunmore, and Wilbur Hinman developed methods for remote weather measurements with the first practical “meteorological radiosonde.” In 1939 they had developed the “remote weather station,” a ground-based radiosonde for automatic telemetering in remote and inhospitable locations. During World War II Diamond was transferred into the newly established Ordnance Division where he materially contributed to the development of the radio proximity fuse. In 1940, he received the Washington Academy of Sciences Engineering Award for his work, and the IRE honored him with its Fellow Award in 1943 for his efforts in radio-meteorology. The successor organization, IEEE, has renamed that award in honor of Harry Diamond. The NBS organization chart listed him as Chief of the

Ordnance Development Division in 1945. Diamond was personally presented with Navy and War Department Certificates for Outstanding Service in 1945 [7]. His untimely death in 1948 was a profound loss for the National Bureau of Standards, which had relied heavily on Diamond’s visions and plans for the post-war development of civilian technology. To honor him, NBS named the newly constructed electronics laboratory the Harry Diamond Laboratories. That organization was turned over to the U.S. Army in 1952 and continues to operate under that name to this day.

Prepared by Hans J. Oser.

Bibliography

- [1] J. H. Dellinger, H. Diamond, and F. W. Dunmore, Development of the Visual Type Airway Radio-Beacon System, *Bur. Stand. J. Res.* **4**, 425-459 (1930).
- [2] F. H. Engel and F.W. Dunmore, A Directive Type of Radio Beacon and Its Application to Navigation, *Sci. Pap. Bur. Stand.* **19**, 281-295 (1923).
- [3] Robert Robinson, Diamond-Dunmore, *Federal Science Progress* **1** (3), 16-20 (1947).
- [4] Rexmond C. Cochrane, *Measures for Progress: A History of the National Bureau of Standards*, NBS Miscellaneous Publication 275, National Bureau of Standards, U.S. Government Printing Office, Washington, DC (1966) pp. 294 ff.
- [5] NBS Research in Navigation, *Tech. News Bull. Natl. Bur. Stand.* **34** (6), 80-85 (1950). (Summary of a talk by Edward U. Condon before the Eastern Regional Meeting of the Institute of Navigation, February 10, 1950.)
- [6] Frank G. Kear, Instrument Landing at the National Bureau of Standards, *IRE Trans. Aeronaut. Navig. Electron.* **ANE-6**, 61-67 (1959).
- [7] Nelson R. Kellog, *I’m Only Mr. Diamond*, A Biographical Essay, Public Affairs Office (History), U.S. Army Laboratory Command, November 1990.

A Hydrogen Isotope of Mass 2

Before the publication of this definitive paper on the discovery of deuterium [1,2], the existence of a heavy isotope of hydrogen had been suspected even though Aston [3] in 1927, from mass spectrometric evidence, had discounted the presence of the heavier isotope at a hydrogen abundance ratio ${}^1\text{H}/{}^2\text{H} < 5000$. (The modern best estimate of that ratio is 5433.78 in unaltered terrestrial hydrogen.) Harold Urey, however, continued to suspect the existence of the heavier isotope, based upon evidence from the sequence of properties of known nuclides and from faint satellite peaks in the Balmer series of the atomic hydrogen spectrum in the visible region. Birge and Menzel [4] had gone further by estimating the abundance ratio ${}^1\text{H}/{}^2\text{H}$ at about 4500 from the difference in the atomic weight of hydrogen measured by chemical versus mass spectrometric means.

Still, the world of science was unwilling to acknowledge the existence of a hydrogen isotope without direct experimental proof. Thus Urey solicited the collaboration of a physicist he had known well at Johns Hopkins University, Ferdinand Brickwedde, who had moved to the National Bureau of Standards after completing his graduate work and had begun to assemble an unexcelled center for thermodynamic measurements, especially at low temperature.

This was a time when isotopes, because of their identical configuration of extra-nuclear electrons, were believed to be chemically inseparable. Prout's old hypothesis of atomic weights being whole-number multiples of that of hydrogen now applied more satisfactorily to isotopes than to elements, but—apart from the effects from some radioactive processes applicable exclusively to elements of high atomic number—all atomic weights were still regarded as constants of nature.

Urey, Brickwedde, and their colleagues evidently did not share that contemporary viewpoint. These scientists had knowledge of the differences in nuclear spins, as well as magnetic and quadrupole moments, between isotopes of the same element. They had mastered quantum physics and thermodynamics, so surely they expected differences in physical and chemical properties and hence would have anticipated some differences in reaction dynamics and equilibria. They probably estimated the chemical differences among isotopes to be small, perhaps too small to be measured by contemporary experiments. Any successful separation, therefore,

was likely to be achievable largely by virtue of the difference in masses of isotopes of the same element. A suspected isotope of hydrogen had a mass two or three times that of the predominant ${}^1\text{H}$. The search for a hypothetical hydrogen isotope caused great excitement and led to a high-stakes competition among laboratories. None exceeded Urey and his coworkers in understanding and determination to find proof for the existence of an isotope of hydrogen by a clear-cut measurement. Actually, Urey and George Murphy had found, but not yet published, spectrographic evidence for the lines of ${}^2\text{H}$ obtained from samples of commercial tank hydrogen. These lines, however, were seen only after long photographic exposures. The suspicion persisted that these extra lines could have arisen from irregularities in the ruling of their grating or from molecular hydrogen.

Urey and Brickwedde recognized that the proportional mass difference of a possible hydrogen isotope ${}^2\text{H}$ or ${}^3\text{H}$ was most likely to show in molecular hydrogen (H_2). A fractional distillation near the hydrogen triple point (about 14 K) gave the best chance of achieving a high concentration of the hypothesized ${}^2\text{H}$. Despite the considerable experimental difficulties, Brickwedde at NBS undertook the attempt to separate partially the hypothetical isotope by fractional distillation of liquid hydrogen [1,2].

Murphy much later [5] recalled the fear of being beaten in the race for priority in a proof for the existence of ${}^2\text{H}$ at a time when Brickwedde reported a manufacturing delay in the large NBS hydrogen liquifier. The delay, however, appears to have been well used. The authors attempted a quantitative calculation of the enrichment to be expected. By making use of the equality of free energy of gas and solid in equilibrium and the Debye theory of the solid state, they calculated, with minor additional assumptions, the ratio of the vapor pressures $p({}^1\text{H}_2)/p({}^1\text{H}{}^2\text{H})$ at the triple point as 2.688.

For the actual experiment Brickwedde started with 400 ft³ of hydrogen gas which was liquefied after precooling with liquid air boiling at reduced pressure. Liquid hydrogen was then fed into a 1.6 L evaporation flask. Evaporation took place until about 1/3 of the hydrogen remained, which was then fed into sample tubes and transported to Columbia University for atomic spectroscopic comparison with normal hydrogen by Murphy [1,2]. Assuming the above-quoted abundance ratio to be 4500 [3], the mole fraction left in the still should by their calculation have increased by a

factor of 4000. (It would have been higher, if ^3H were involved.) Although the concentration factor of 4000 was never achieved, the ^2H concentration was so greatly enhanced that its existence could be demonstrated from the spectroscopic measurements without any remaining doubt. A Letter to the Editor [1] narrowly achieved the desired priority and alerted the scientific community to the upcoming full paper [2], which was recognized as much for the low-temperature advances—the first of a series of similarly significant low-temperature measurements related to superconductivity at NBS [6]—as for the scientific significance of a separable stable hydrogen isotope. This full paper [2] earned Urey the 1934 Nobel Prize for Chemistry.

Although he refrained from stealing the limelight and the priority from the Urey, Brickwedde, and Murphy classic experiment, Edward Washburn of NBS, in association with Urey [7], published in 1931 a demonstration of the existence of ^2H based upon a simpler and subsequently much more important method of enrichment. Washburn and Urey argued that chemically unbonded $^2\text{H}^+$ might have a lower mobility and/or higher cathodic potential in electrolysis. In fact, such concentration was demonstrated in a number of samples, including those from residual solutions from commercial electrolytic cells that had operated continuously for two to three years. These samples were examined spectroscopically by Murphy at Columbia, and the quantification of the enrichment was also carried out at NBS using water density measurements. The high accuracy of these measurements stands as a great tribute to NBS. This work is recorded in many papers authored or co-authored by E. R. Smith. In a very elegant experiment, for example [8], the authors compared the densities of four kinds of samples: natural water, water prepared by combining hypothetically enriched hydrogen with normal oxygen, water prepared by combining natural hydrogen with enriched oxygen, and water prepared by combining hypothetically enriched hydrogen with enriched oxygen. Thus they were able to show not only that the ^2H enrichment is real, but that the enrichment of the higher isotopes of oxygen is also measurable. Washburn showed great ingenuity in searching out waters that were enriched or denuded in ^2H . In one experiment he and his son compared water from sap taken from the top of a tree with water from the roots. The results showed conclusively that ^2H existed and that isotopic compositions, and also atomic weights, could no longer be regarded as invariable.

The ^2H isotope, as early as in 1934 [9], was named by Urey as deuterium (symbol D) with a nucleus called deuteron (symbol d). As is common to many significant discoveries in science, this event was widely anticipated but, in contrast with most other discoveries, its

applications followed swiftly. Within a year, an NBS group had used isotopic composition in an electrolytic process control. A Cambridge group under Rutherford [10] had prepared deuterated compounds such as D_3PO_4 , bombarded them with deuterons, and correctly identified the reaction: $\text{D}+\text{D} = \text{T}+\text{H}$ (T is the symbol for the new radioactive isotope of hydrogen of mass 3, called tritium). The nuclear reaction type (d,n) was also identified, in which the neutron that is produced carries off the excess energy in the deuteron (the excess energy over that of a neutron separated from the nucleus of ^1H). Within a decade of the discovery of D, the thermodynamic properties of the hydrogen isotopic species had been measured (see, for example, Fig. 1) and definitive values published by NBS [11]. Furthermore, the application to a fledgling nuclear industry was realized, and the cosmological significance began to be appreciated.

The literature resulting from the discovery of deuterium grew very fast. As early as 1935, Urey with Gordon Teal [12], who much later became Director of the NBS Institute for Materials Research, wrote a comprehensive review of the methods of separation of deuterium, its properties in gas, liquid, and solid phases, the chemical kinetics of deuterated compounds, analytical applications for deuterium, the nuclear spin and

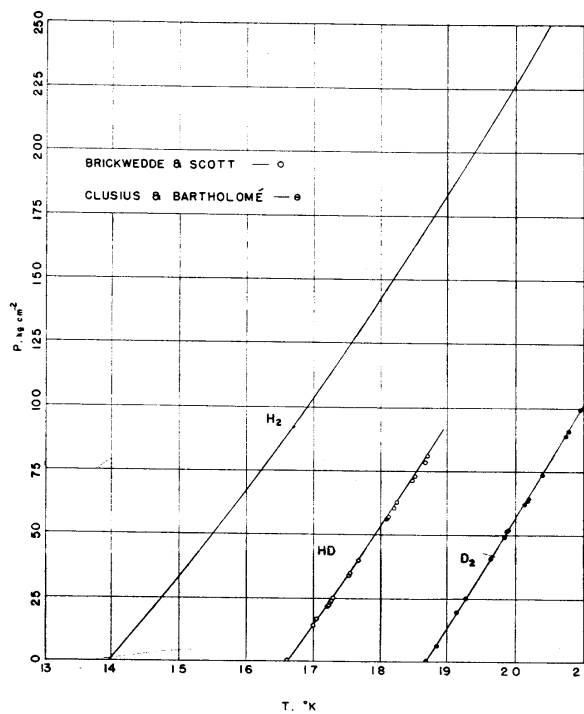

Fig. 1. Melting point pressure as a function of temperature for H_2 , HD, and D_2 (from [11]).

moments, and the atomic and molecular spectra. The discovery of deuterium had started a whirlwind of change in science.

The above description may give the false impression of a straightforward, orderly path to the discovery of deuterium. To correct that illusion, the reader might enjoy reading Brickwedde's memoirs [13] written after all the dust had settled and after Urey, Murphy, and Washburn had died. In that article Brickwedde first pays great tribute to Urey "who proposed, planned, and directed the investigation. Appropriately, the Nobel Prize for finding the heavy isotope of hydrogen went to Urey." Brickwedde then points out that the work stumbled on by a succession of errors, some detrimental, some accidentally fortunate to furthering progress. One such error was made on authoritative, but false, advice that electrolysis could not alter significantly the hypothetical isotopic composition of hydrogen, so that the first sample of hydrogen used by Brickwedde for fractional distillation by the above described *tour de force* was already denuded in deuterium! At that juncture, Washburn at NBS was again the hero who suggested the preparation of the hydrogen sample was faulty.

After receiving the degree of AB (chemistry) and PhD (physics and mathematics) from Johns Hopkins University, Ferdinand Graft Brickwedde started at NBS in 1925 as postdoctoral Mansell Research Associate. In 1926 he became Chief of the Low Temperature Laboratory. In 1946 the Heat and Power Division was restructured and Brickwedde was appointed its Chief in recognition of his leadership potential. At the same time Brickwedde organized and led the Thermodynamics Section, one of the component parts of the new Division. Besides his key contributions to the discovery of deuterium, his research covered a diversity of topics including measurement of thermodynamic properties, the liquefaction of gases, the superfluidity of liquid helium II, the absolute temperature scale, applications of refrigeration, solar energy, rheology, octane rating, and the properties of deuterium compounds. Simultaneously with his appointment at NBS, Brickwedde served as a part-time physics professor at the University of Maryland, where he gave graduate courses in statistical mechanics, relativity, electrodynamics, and quantum mechanics. He organized the University of Maryland Extension Program in physics at NBS. This program was important in that it gave opportunities for NBS staff to keep abreast of current developments in specialized fields, to acquire knowledge in new fields, and to satisfy interests to teach while at a non-academic establishment. It also enabled many young staff members at NBS and

other Federal agencies to satisfy their course requirements towards advanced degrees by attending classes at NBS after working hours. He also was consultant to Los Alamos Scientific Laboratory, the University of California Lawrence Livermore Laboratory, and a commission member of the International Institute of Refrigeration and the International Union of Pure and Applied Physics. Brickwedde won the Hillebrand Prize of the Chemical Society of Washington and was Associate Editor of *The Physical Review*. As NBS expanded in the early 1950s, he helped recruit young PhDs for the new programs. He and his wife, Langhorne Howard Brickwedde, an NBS electrochemist, were gracious hosts to many of the new arrivals. In 1956 Brickwedde, when only 53 years old, left NBS to accept the post of Dean of Physics and Chemistry at Pennsylvania State University and, in 1978, the Evan Pugh Research Professorship there. He died in 1989 at the age of 86.

Prepared by Walter J. Hamer and H. Steffen Peiser.

Bibliography

- [1] H. C. Urey, F. G. Brickwedde, and G. M. Murphy, A Hydrogen Isotope of Mass 2, *Phys. Rev.* **39**, 164-165 (1932).
- [2] H. C. Urey, F. G. Brickwedde, and G. M. Murphy, *Phys. Rev.* **40**, 1-15 (1932).
- [3] F.W. Aston, Bakerian Lecture— A new mass-spectrograph and the whole number rule, *Proc. R. Soc. London* **A115**, 487-514 (1927).
- [4] R. T. Birge and D. H. Menzel, The relative abundance of the oxygen isotopes and the basis of the atomic weight system, *Phys. Rev.* **37**, 1669-1671 (1931).
- [5] G. M. Murphy, The Discovery of Deuterium, in *Isotopic and Cosmic Chemistry*, H. Craig, S. L. Miller, and G. W. Wasserburg (eds.), North-Holland Publishing Company, Amsterdam (1964).
- [6] F. G. Brickwedde, R. P. Hudson, and E. Ambler, Cryogenics, *Annu. Rev. Phys. Chem.* **6**, 25-44 (1955).
- [7] E. W. Washburn and H. C. Urey, Concentration of the H² Isotope of Hydrogen by the Fractional Electrolysis of Water; *Proc. Natl. Acad. Sci. U.S.A.* **18**, 496-498 (1932).
- [8] E. W. Washburn, E. R. Smith, and F. A. Smith, Fractionation of the isotopes of hydrogen and of oxygen in a commercial electrolyzer, *J. Res. Natl. Bur. Stand.* **13**, 599-608 (1934).
- [9] Harold Clayton Urey, in *Nobel Lectures, Chemistry 1922-1941*, Elsevier Publishing Company, Amsterdam (1966) pp. 331-356.
- [10] M. L. E. Oliphant, B. B. Kinsey, and Lord Rutherford, The transmutation of lithium by protons and by ions of the heavy isotope of hydrogen, *Proc. R. Soc. London* **A141**, 722-733 (1933).
- [11] H. W. Woolley, R. B. Scott, and F. G. Brickwedde, Compilation of thermal properties of hydrogen in its various isotopic and ortho-para modifications, *J. Res. Natl. Bur. Stand.* **41**, 379-475 (1948).
- [12] H. C. Urey and G. K. Teal, The hydrogen isotope of atomic weight two, *Rev. Mod. Phys.* **7**, 34-94 (1935).
- [13] F. G. Brickwedde, Harold Urey and the Discovery of Deuterium, *Phys. Today* **35** (9), 34-39 (1982).

Air Flow and Turbulence in Boundary Layers

Shortly after arriving at NBS in 1929 as an employee in the Electrical Division, Galen B. Schubauer enrolled in a graduate study program at Johns Hopkins University in Baltimore, as did about two dozen of his newly hired colleagues. These studies required a commute to Baltimore several times per week. The difficult trip was made more efficient by cramming six to eight students into a 1930s sedan, which made the trip much more arduous. During his graduate studies, Schubauer's interest began to focus on aerodynamics, and on boundary layer phenomena in particular. Consequently, he transferred to the Aerodynamics Section of NBS, then headed by Hugh L. Dryden, where he began an illustrious career of research on this topic.

His 1935 paper, *Air Flow in a Separating Boundary Layer* [1], provided great insight into separation (or stall) of a laminar boundary layer developing over an airfoil with the cross-section of an elliptic cylinder. The purpose of the work was to test an approximate solution to the applicable flow equations advanced by K. Pohlhausen. Schubauer's experimental results showed that Pohlhausen's solution produced good agreement in the forward portion of the surface, but it began to fail near the separation point on the surface and could therefore not be used to predict the location of the separation point. The next paper, *The Effect of Turbulence on the Drag of Flat Plates* [2], concerned the effects of free-stream turbulence on four objects: a flat plate, a thin circular disk, a vane anemometer, and a Pitot static tube. The results indicated that there is no appreciable effect of turbulence on the vane anemometer and the Pitot static tube, but there is a small effect on the drag of a flat plate and on the pressure difference between the front and rear of a disk. Furthermore, the effect of turbulence was found to be independent of the air speed or Reynolds Number.

The hot-wire anemometer had emerged as the fundamental instrument for measuring boundary layer turbulence as well as boundary layer velocity distributions. This instrument was known to be sensitive to other parameters which could cause errors in the turbulence and velocity measurements if proper corrections were not made. Water vapor (humidity) in the air stream was recognized to be such a possible extraneous parameter. In his next paper [3], Schubauer quantified this effect by verifying recent results published by W. Paeschke which

showed that the effect was to increase the hot-wire heat loss at higher humidities, giving a fractional change of about 2 % for an increase in relative humidity from 25 % to 70 %. It was concluded that the phenomenon could be explained by the effect of humidity on the thermal conductivity of air.

During the next decade, Schubauer continued to focus his attention on the stability of the laminar boundary layer. He was particularly interested in an instability theory which had been under development over a 40-year period and which was published in the mid-1930s by two German investigators, W. Tollmien and H. Schlichting, who were working independently. This theory postulated that a small disturbance introduced into a laminar boundary layer would lead to transition of the laminar layer to a turbulent boundary layer, depending primarily upon the frequency of the disturbance and the longitudinal (in the flow direction) Reynolds Number. For certain values of the governing parameters the disturbance would be amplified and transition would occur, but for other parameter values the disturbance would be attenuated (or damped) and would not cause transition. The regions where disturbances are amplified or damped are separated by a curve of "neutral stability" as shown in Fig. 1. This curve is sometimes referred to as a "Tollmien-Schlichting noodle curve" because of its peculiar shape.

Working during the mid-1930s on his own time and with available equipment, Schubauer began to investigate the T-S theory experimentally. His jury-rigged experimental setup was substantially less than ideal, but he was able to acquire enough data to convince himself that the T-S theory was basically valid. However, Dryden argued that the relatively crude experimental setup employed by Schubauer could not possibly allow measurement of the T-S phenomenon. There were too many extraneous sources of disturbances in the flow, and the signal-to-noise ratio of the available hot-wire instrumentation was insufficient. Substantial improvement of the experimental equipment would be required to provide necessary control of all the parameters and make high quality measurements. Because of higher priorities, Dryden would neither allow any of the Aerodynamic Section's current financial resources to be used for this work nor assist in soliciting additional funds for the research.

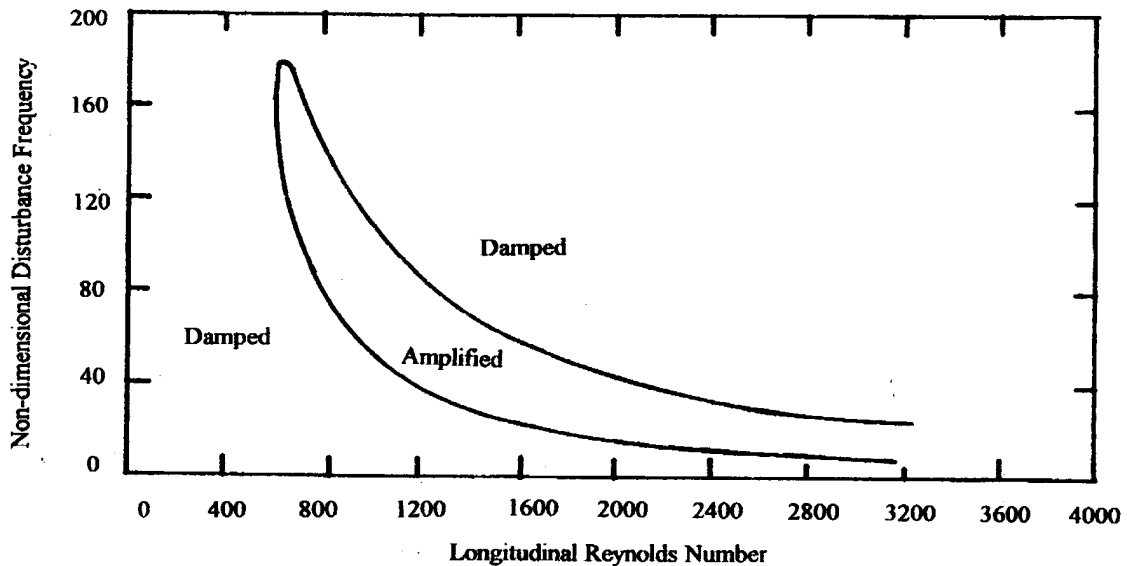

Fig. 1. Zone of Amplification Enclosed by Neutral Curve, According to Schlichting.
(Adapted from Figure 13 of [4])

As time passed, Schubauer persisted and continued to work nights and weekends with available equipment to refine his experimental setup. Finally, in the late 1930s, he was able to accumulate enough data to convince Dryden that he was, in fact, able to measure and verify the results of disturbances of known frequencies injected into a laminar boundary layer and that the results consistently fell very close to the T-S theory's predictions.

In the late 1930s, Dryden actively helped Schubauer in securing funding to pursue this work. As World War II approached, its value to the war effort was recognized and it was given a Confidential classification. Now the problem was no longer funding, but securing the materials and equipment necessary to conduct a well-controlled experiment in a war-time economy. However, as the war progressed, advances in the field of electronics were of great help in producing components with which hot-wire instrumentation of higher signal-to-noise ratio could be built, and ways were found to reduce the wind tunnel free-stream turbulence levels below the required level of about 0.1 % of flow rate.

As a result of the Confidential classification placed on the work, Schubauer and his colleagues were prevented from publishing anything about it until after World War II, except as an advance National Advisory Committee for Aeronautics (NACA) Confidential Report in 1943. By 1947, after Dryden had become the head of NACA and Schubauer had become chief of the NBS Aerodynamics Section, the work was published in the open literature in the *Journal of Research of the National Bureau of Standards* [4]. The paper was

co-authored by H. K. Skramstad, who was now chief of the NBS Guided Missiles Section and who contributed improvements to the hot-wire instrumentation and other electronic components of the test apparatus. The results were also published in other media, and additional publications by Schubauer and his colleagues about this same time described associated research work.

The T-S theory and its experimental verification by Schubauer and Skramstad contributed greatly to the fundamental understanding of the transition of fluid boundary layers from laminar to turbulent flow. This has led to extensive work in boundary layer control resulting in a myriad of designs for controlling transition to make lifting surfaces, internal flows, and submerged vehicles more efficient. The value of the work has been recognized to the extent that it was nominated for the Nobel Prize in Physics.

Galen Brandt Schubauer was born in Mechanicsburg, PA. He graduated from Pennsylvania State University and received a master's degree in physics from the California Institute of Technology and a doctorate in physics from Johns Hopkins University. His honors included the Fluid Dynamics Prize of the American Physical Society, which he received in 1988 for seminal research findings that concerned the design of wind tunnels and other aspects of research. In 1944 he was the recipient of the Washington Academy of Sciences award for achievement in engineering sciences, and in 1947 he shared the Sylvanus Albert Reed Award of the Institute of Aeronautical Sciences. He was a fellow of the American Physical Society, the Washington Academy of Sciences, and the American Institute of



Fig. 2. Galen B. Schubauer.

Aeronautics and Astronautics. He was a member of the National Academy of Engineering and of the Philosophical Society of Washington.

Upon his retirement from NBS in 1968, Allen V. Astin, then Director of NBS, wrote “Few men have served longer at the National Bureau of Standards than Galen B. Schubauer, and probably none with more dedication. His reputation as an international authority in fluid mechanics, particularly in aerodynamics, reflected credit on the man and, secondarily, on NBS itself. Certainly the papers of Dr. Schubauer are of interest to his friends, to this institution, and to the scientific community. They cover a period of time in which science, technology, and the world itself were completely transformed; yet his last papers are as relevant as his earliest. . . .”

A bound volume [5] containing all of Schubauer’s scientific publications that could be found (totaling 25) was prepared by colleagues and given to the NBS library. In the preface to this volume, P. S. Klebanoff wrote “On April 30, 1968, Dr. Galen Brandt Schubauer retired from the National Bureau of Standards. His association with the Bureau was a most fruitful and illustrious one, spanning a period of almost 38 years. . . . His research on boundary layers, flow instability and turbulence not only provided new insight into these important problems, but also provided for new avenues of approach both theoretical and experimental. His work contributed to the prestige of the National Bureau of Standards and in large measure was responsible for the stature of the Aerodynamics Section in the scientific community. Many of his publications are widely cited and are regarded as classical references in the field. . . .”

Klebanoff continued, “It is perhaps a comment on man’s nature that the occasion of one’s retirement is one of the few times that it is considered appropriate to express respect and affection. . . .”

Prepared by Norman E. Mease and James E. Potzick.

Bibliography

- [1] Galen B. Schubauer, *Air Flow in a Separating Laminar Boundary Layer*, NACA Report No. 527, National Advisory Committee for Aeronautics (1935).
- [2] Galen B. Schubauer and Hugh L. Dryden, *The Effect of Turbulence on the Drag of Flat Plates*, NACA Report No. 546, National Advisory Committee for Aeronautics (1935).
- [3] Galen B. Schubauer, Effect of Humidity on Hot-Wire Anemometry, *J. Res. Natl. Bur. Stand.* **15**, 575-578 (1935).
- [4] Galen B. Schubauer and Harold K. Skramstad, Laminar Boundary-Layer Oscillations and Transition on a Flat Plate, *J. Res. Natl. Bur. Stand.* **38**, 251-292 (1947).
- [5] G. B. Schubauer, *Collected Papers, 1933–1968*. Available through the library of the National Institute of Standards and Technology.

Thermodynamic Properties of Water and Steam for Power Generation

In the early 1900s, the electric power generation industry was experiencing rapid growth and change. The steam engines used for power in the previous century had been displaced by turbines which generated electricity as they were rotated by pressurized steam generated in boilers. Turbines and boilers were operating at higher temperatures and pressures (and also in increasingly complex cycles, which required more sophisticated thermal design and analysis) in order to attain greater thermodynamic efficiency. They were also becoming larger as the demand for electricity skyrocketed.

A major source of growing pains for the industry was the lack of accurate and standardized values for the properties of water and steam. For the design of power plants and the boilers and turbines within them, it is necessary to have accurate values of thermodynamic quantities such as the vapor pressure (pressure at which water boils at a given temperature) and the enthalpy of vaporization or latent heat (amount of heat required to generate steam from liquid water). More important, the evaluation of the performance of purchased equipment depends on the calculation of these properties. The efficiency of a turbine is measured as the fraction of the energy available in the steam that is converted to electricity, but that available energy is calculated to be a different number depending on the values used for the thermodynamic properties. A turbine might appear to be 28 % efficient with one set of properties and only 27 % efficient with another set; because of the large flows involved, these small differences could mean large sums of money. It therefore became imperative to settle on internationally standardized values for the properties of water and steam, so that all parties in the industry could have a “level playing field” on which to compare bids and equipment performance. The paper *Calorimetric Determination of the Thermodynamic Properties of Saturated Water in both the Liquid and Gaseous States from 100 to 374 °C* [1] describes the accurate measurements carried out at NBS that were essential in reaching agreement on the needed standards.

In the United States, this problem was first addressed in 1921 by a group of scientists and engineers brought together by the American Society of Mechanical Engineers (ASME). The 1921 meeting led to the formation of the ASME Research Committee on Thermal Properties of Steam. This committee, recognizing the

need for reliable data, collected subscriptions from industry and disbursed the money to support experimental measurement of key properties of water and steam at Harvard, MIT, and the Bureau of Standards. Because the ASME committee was not as successful in their fundraising as they had hoped, all three institutions ended up subsidizing some of the research themselves in recognition of its importance.

The need for standard, reliable data was also recognized in other countries (notably England, Germany, and Czechoslovakia), and research efforts were coordinated internationally. In the late 1920s and early 1930s, three international conferences were held with the purpose of agreeing on standardized values for the properties of water and steam. This culminated in 1934 with the adoption of a standard set of tables, covering the range of temperatures and pressures of interest to the power industry at that time. These tables gave the vapor pressure as a function of temperature, values of the volume and enthalpy for the equilibrium vapor and liquid phases along the vapor-pressure curve, and volumes and enthalpies at points on a coarse grid of temperatures and pressures. Each value had an uncertainty estimate assigned to it. The data those tables were based on also became the basis for a book of “Steam Tables” produced by J. H. Keenan and F. G. Keyes [2]; the Keenan and Keyes tables were the *de facto* standard for the design and evaluation of steam power generation equipment worldwide for the next 30 years.

The most important data behind these new steam tables came from the laboratory of Nathan S. Osborne at the National Bureau of Standards. Through most of the 1920s and 1930s, Osborne and his coworkers painstakingly built equipment and conducted measurements. The ASME had originally hoped for data within three years of the project’s 1921 start, but fortunately they were patient (and grateful to the NBS for subsidizing the work) and continued to support the project through years of pioneering, but often frustrating, apparatus development. Finally, beginning in the late 1920s, their patience was rewarded as data of unparalleled quality began coming from Osborne’s laboratory.

The primary experimental technique was calorimetry, in which a measured amount of heat is added to a fluid under controlled conditions. Osborne and coworkers had previously performed calorimetric measurements on ammonia. For measurements on water, several new

calorimeters were developed. One of these, constructed from copper and used for the region below 100 °C, has been preserved in the NIST museum; it is shown in Fig. 1.

The region of most industrial importance, however, was at much higher temperatures (and correspondingly higher pressures), well beyond what had been encountered in the ammonia work. Experiments at these conditions were also more difficult because water is very corrosive at high temperatures. We briefly describe the calorimeter that was built to overcome these difficulties and that was used to take the data reported in the Osborne, Stimson, and Ginnings paper [1].

The heart of the calorimeter was a heavy-walled 325 cm³ vessel of chromium-nickel steel. The contents were not stirred to achieve thermal equilibrium; instead, heat was diffused by 30 internal silver fins. The vessel contained a heater and carried a miniature platinum

resistance thermometer. The calorimeter was shielded from the environment by two concentric silver shields that were maintained at the calorimeter temperature at all times. The calorimeter had two valves. The valve at the top allowed a measurable amount of vapor to be extracted, and the bottom valve allowed extraction of a known amount of liquid water. The water simultaneously served as a pressure transfer medium to allow measurement of the saturation pressure. During extraction of either vapor or liquid, the remaining liquid would partially evaporate, and heat was supplied to the calorimeter in order to keep the temperature constant.

The calorimeter was operated in three different modes. The two isothermal modes in which either liquid or vapor was extracted provided information on the latent heat (enthalpy) of vaporization. The calorimeter could also be sealed and heated, giving information on the enthalpy and heat capacity of the liquid. By combining these measurements with the vapor pressure data and applying thermodynamic relationships, the specific volumes and enthalpies of the coexisting phases were calculated. The caloric properties, particularly the heat of vaporization, are the key data for the design and evaluation of steam power generation equipment because they determine the heat that must be added in the power cycle and the energy available in the steam to be converted to electricity in the turbines.

These investigations covered the range from water's freezing point (0 °C) to the end of the vapor pressure curve at the critical point (approximately 374 °C with a pressure near 22 MPa, over 200 times normal atmospheric pressure). They were reported in a series of papers [1, 3, 4, 5]. Reference [1] reports the heat of vaporization and enthalpy data at higher temperatures, which have proved to be the most industrially important of these data over the years.

The impact of this work was both immediate and enduring. As already mentioned, Osborne's data were incorporated (sometimes before they had even been published) into the steam tables desperately needed by industry at the time. Over 60 years later, much of the data, notably the heats of vaporization, are still the most accurate available. Many new steam tables have been produced through the years, including several generations of official replacements for the 1934 international standards. While these tables have taken advantage of some newer data, particularly at higher temperatures and pressures, the Osborne data have continued to be the backbone of all international water property standards. It is not an exaggeration to say that these data are fundamental to the design and operation of all steam power-generation facilities in the world today.

With the completion of Osborne's work in 1939, the most pressing industrial need for steam data had been

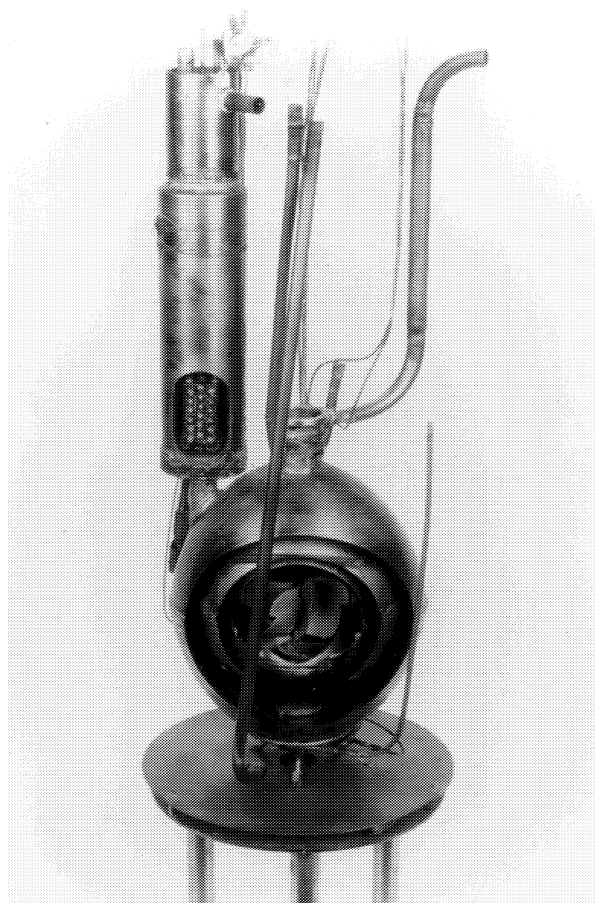

Fig. 1. Calorimeter used by Osborne et al. to study water properties at temperatures below 100 °C.

met. However, water property standards continued to be improved as new data were taken and as better means for representing data were developed. These standards are important not only for the steam power industry, but also for other industries such as chemical processing. Accurate water property standards are also needed for scientific research, both because of the direct scientific importance of water and because water is commonly used as a calibration standard. The NBS (and later NIST) remained involved with these standards as an active participant in the international conferences that eventually evolved into the International Association for the Properties of Water and Steam (IAPWS). Howard J. White of NBS maintained the Secretariat of the Association for many years. When new international standards were adopted in the 1960s, Joseph Hilsenrath of NBS, an early leader in the application of computers to the analysis of scientific and engineering data, was involved in their development and dissemination. An improved representation of water and steam properties was adopted in 1984 under the leadership of NBS's Lester Haar, and tables from that formulation were published as the widely distributed *NBS/NRC Steam Tables* [6].

The 1990s saw a new generation of improved property formulations, taking advantage of both new data and improved computer optimization techniques. IAPWS coordinated the international development and testing efforts for these formulations. The latest state-of-the-art representation of water's thermodynamic properties was adopted by IAPWS in 1995 [7], and properties calculated from current IAPWS standards for general and scientific use are distributed in a computer program by the NIST Standard Reference Data program [8]. IAPWS also maintains a separate "industrial" standard specifically for the steam power industry [9]; this standard sacrifices some accuracy in order to meet the special requirements (computational speed and less frequent revision) of that industry. NIST, through the involvement of its personnel in the ASME subcommittee which is the U.S National Committee for IAPWS, has done much of the work in disseminating the new industrial standard in the United States [10]. All of these standards, from the 1930s to the present, have been anchored by the data of Nathan Osborne and his coworkers.

Nathan S. Osborne graduated from the Michigan College of Mines (now Michigan Technological University) in 1899. He was one of the earliest employees of the National Bureau of Standards, beginning his career there in 1903. Except for a period of two years, when he returned to Michigan to teach at his *alma mater*, he remained at the NBS until his retirement in 1939. During this time, he rose from the humble status of Laboratory Assistant to the prestigious rank of

Principal Physicist. Prior to his work on water and steam, Osborne was part of an effort, funded by special Congressional appropriation at the behest of the refrigeration industry, to measure properties of interest in refrigeration. The most significant result of this work was a set of "ammonia tables" [11] that served as a standard for many years. The latter half of his career was mostly occupied by the work on water and steam; recognition for this work included honorary doctorates from his alma mater and from the Stevens Institute of Technology. Osborne died in 1943 at the age of 68.

Harold F. Stimson received a Ph.D. in physics from Clark University in 1915. His advisor, A. G. Webster, was one of the founders of the American Physical Society, and in the 1890s had been one of the first scientists to advocate the creation of a national standards laboratory. Stimson (known affectionately as "Stimmy" to his colleagues) was hired by NBS in 1916 and worked on the ammonia and water projects with Osborne. Most of his subsequent work was concerned with temperature measurement; he represented the United States in the deliberations that resulted in a new International Temperature Scale in 1948 and participated in its 1960 revision. He reluctantly retired in 1960 (later describing reaching the then-mandatory retirement age as being "fired"), but continued his interest in gas thermometry research at the NBS for many more years. He was known for giving haircuts to his colleagues; this, too, continued after retirement. He maintained a large vegetable garden, which he plowed using his station wagon, until he was well into his 80s. An active mountaineer, he also played the cello and is on record as a member of the Bureau of Standards orchestra in 1918. Stimson died in 1985 at the age of 94.

Defoe C. Ginnings began his career at NBS after receiving his Ph.D. in chemistry from the University of Illinois in 1929. He worked at NBS for the next 40 years, using calorimetry and other techniques to measure properties of fluids and solids, often at extreme conditions. The calorimeters he designed were at the leading edge of measurement technology. In addition to the work on water and steam, he took important calorimetric data on a number of hydrocarbons, which proved very valuable to the petroleum processing industries, and made high-temperature measurements of materials important in the defense and space programs. Ginnings was known for his personal modesty and for his dedication to pioneering and high-quality experimental work. He served as Chief of the Heat Measurements Section through most of the 1960s. He died in 1971 at the age of 65.

Prepared by Allan H. Harvey, with assistance from Johanna M. H. Levelt Sengers.

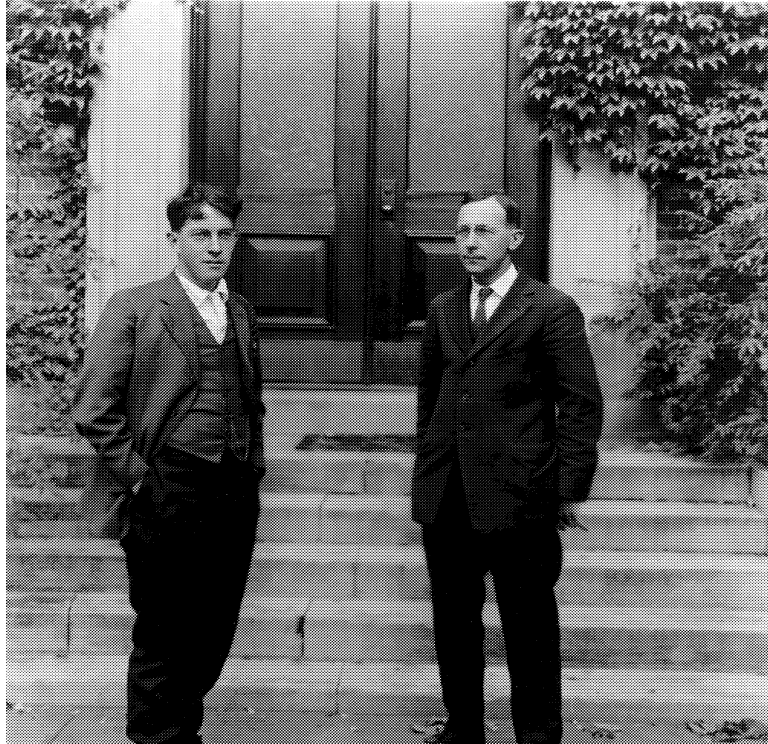

Fig. 2. Harold Stimson (left) and Nathan Osborne in 1923, roughly the time when they were beginning their experimental work on water.

Bibliography

- [1] N. S. Osborne, H. F. Stimson, and D. C. Ginnings, Calorimetric Determination of the Thermodynamic Properties of Saturated Water in both the Liquid and Gaseous States from 100 to 374 °C, *J. Res. Natl. Bur. Stand.* **18**, 389-447 (1937).
- [2] Joseph Henry Keenan and Frederick G. Keyes, *Thermodynamic Properties of Steam Including Data for the Liquid and Solid Phases*, John Wiley and Sons, New York (1936).
- [3] N. S. Osborne, H. F. Stimson, and E. F. Fiock, A Calorimetric Determination of Thermal Properties of Saturated Water and Steam from 0 to 270 °C, *Bur. Stand. J. Res.* **5**, 411-480 (1930).
- [4] N. S. Osborne, H. F. Stimson, E. F. Fiock, and D. C. Ginnings, The Pressure of Saturated Water Vapor in the Range 100 to 374 °C, *Bur. Stand. J. Res.* **10**, 155-188 (1933).
- [5] Nathan S. Osborne, Harold F. Stimson, and Defoe C. Ginnings, Measurements of Heat Capacity and Heat of Vaporization of Water in the Range 0 to 100 °C, *J. Res. Natl. Bur. Stand.* **23**, 197-260 (1939).
- [6] Lester Haar, John S. Gallagher, and George S. Kell, *NBS/NRC Steam Tables: Thermodynamic and Transport Properties and Computer Programs for Vapor and Liquid States of Water in SI Units*, Hemisphere Publishing Corporation, Washington, DC (1984).
- [7] W. Wagner and A. Pruss, New International Formulation for the Thermodynamic Properties of Ordinary Water Substance for General and Scientific Use, *J. Phys. Chem. Ref. Data*, to be published.
- [8] A. H. Harvey, A. P. Peskin, and S. A. Klein, *NIST/ASME Steam Properties*, NIST Standard Reference Database 10, Version 2.2, Standard Reference Data Program, National Institute of Standards and Technology, Gaithersburg, MD (2000).
- [9] W. Wagner, J. R. Cooper, A. Dittmann, J. Kijima, H.-J. Kretzschmar, A. Kruse, R. Mareš, K. Oguchi, H. Sato, I. Stöcker, O. Šifner, Y. Takaishi, I. Tanishita, J. Trübenbach, and Th. Willkommen, The IAPWS Industrial Formulation 1997 for the Thermodynamic Properties of Water and Steam, *J. Eng. Gas Turbines Power, Trans. ASME* **122**, 150-182 (2000).
- [10] William T. Parry, James C. Bellows, John S. Gallagher, and Allan H. Harvey, *ASME International Steam Tables for Industrial Use*, ASME Press, New York (2000).
- [11] *Tables of Thermodynamic Properties of Ammonia*, Circular of the Bureau of Standards, No. 142, U.S. Government Printing Office, Washington, DC (1923).

Absolute Pressure Calibrations of Microphones

Historically, various techniques have been used in acoustics to attempt to establish and to measure sound pressures. At present the most accurate, precise, and convenient methods over a broad range of frequencies involve the primary calibration of laboratory standard microphones by “reciprocity techniques.” The adoption of these reciprocity techniques followed many years of exacting work involving other measurement techniques and other investigators. In the paper, *Absolute Pressure Calibrations of Microphones* [1], Richard K. Cook provided both theoretical and practical understanding of these new techniques. By rigorous, systematic experimental work and analysis, he demonstrated the weaknesses of certain older, previously dominant methods. Then, by comparing results from these older methods with those of the new reciprocity techniques, he established the superiority of the latter. Reciprocity techniques were soon employed in critical inter-laboratory comparisons, which quickly led to the elevation of these techniques to their dominant status as the preferred method in primary acoustical calibrations and measurements of sound pressure.

These measurements are important because sound pressure, which is usually expressed as decibels relative to a reference pressure of 20 μPa [2], is a critical measure of acoustical signals. These signals may be speech, music, or noise. Excessive sound pressure causes hearing loss, interference with speech reception, disrupted sleep, and other annoyances. A very large and increasing number of national and international legal, regulatory, and quality control standards for health, safety, and commerce depend on measurements of sound pressure. Primary methods at national metrology institutes (NMIs) support these needs via various explicit or implicit chains of traceability. Such chains relate measurements that necessarily entail high accuracy (for example, those of major calibration laboratories and instrument manufacturers) to measurements that require lesser accuracy, such as practical laboratory and field verifications and checks supporting survey measurements for occupational hearing conservation purposes.

Cook’s paper can be appreciated by considering it in the historical context of some of the many techniques that have been used to determine sound pressures in given kinds of sound fields. All techniques have relative advantages and disadvantages with regard to uncertainty, applicable ranges of frequency and amplitude,

and convenience. At various times, particular techniques and apparatus became favored or dominant, and were in turn superseded by newer methods.

In the late nineteenth century Rayleigh [3] determined the threshold of human hearing by using a microscope with an eyepiece-micrometer to measure the displacement amplitude of the vibrating prongs of a tuning fork, which excited an acoustical resonator as a sound source. Later researchers in the twentieth century [4,5,6,7] sought better and more convenient sound sources of known strength, or better instruments for measuring sound fields. The thermophone used an alternating current (sometimes superposed on a larger direct current) to produce a periodic variation of temperature in a conductive wire or foil. The temperature variation in the wire or foil caused a layer of gas to expand and contract, thereby producing a calculable sound pressure. However, the method had numerous components of uncertainty that were difficult to correct for. Thermophones now are seldom, if ever, used for primary calibrations.

Cook’s introduction of the reciprocity method . . . and many other accomplishments were recognized in 1988 when the Acoustical Society of America awarded him its Gold Medal “ . . . for outstanding seminal contributions to diverse areas of acoustics and to standardization.”

Another calculable source of sound pressure is the pistonphone, in which one or more mechanically driven pistons produce a known time-varying volume displacement in a small (relative to a wavelength of sound) cavity of known volume. Practical mechanical problems have limited pistonphones to use at low frequencies, on the order of 250 Hz.

The electrostatic actuator attempts to apply a known source of equivalent sound pressure to the electrically conductive diaphragm of a microphone. This device uses an electrically conductive plate (usually slotted or

perforated) to which an alternating voltage is applied relative to the microphone diaphragm. From the resulting alternating force of electrostatic origin, the equivalent sound pressure on the diaphragm is calculated. As Madella [8] recognized, the actuator-determined response of a microphone only approximates calibration in the sound pressure field (this is often called a pressure calibration). However, actuators are accurate enough to be used for secondary calibrations.

The invention of the wide-frequency-range capacitor (condenser) microphone by Wentz [9] provided the next advance in instrumentation for sound pressure measurements. The sensitivity of this device could be calibrated by primary sources, and the microphone could then be used to measure sound pressure. Wentz used both a pistonphone and a thermophone to calibrate the microphone [10]. He called this microphone a transmitter, a word usage still found in present-day telephone terminology, although much of the other literature uses "transmitter" to mean a microphone driven as a sound source. In the acoustics literature "response" is often used equivalently with "sensitivity." The unit of sensitivity is now expressed as the ratio of SI derived units V/Pa, but the older literature, including reference [1], uses the ratio (cm² volts)/dyne. The sensitivity level (response level) of a microphone is now usually expressed in decibels (dB) with respect to the reference quantity 1 V/Pa.

Research continued as systematic differences between different sources of sound pressure became evident. By 1932 Ballantine [11] described not only the theory of the pistonphone, but also the underlying mathematical physics and some experimental results for the electrostatic actuator, the thermophone, and a small moving-coil sound source for which the output plane-progressive-wave sound pressure was measured by the Rayleigh disk method (also described in [4,5] with further references).

In 1940, Cook's analysis of these systematic differences led to his introduction of what became known as the reciprocity method for the pressure calibration, or determination of pressure sensitivity, of microphones [1]. From extensive experiments, Cook observed good agreement between calibrations by reciprocity and those carried out using the electrostatic actuator, the pistonphone, and the optically measured displacement amplitude of smoke particles. However, he also observed discrepancies between calibrations using thermophone methods in air, hydrogen, and helium, as well as discrepancies between these thermophone methods and the other methods that among themselves produced consistent agreement. His theoretical and experimental

work, along with the independent theoretical work of MacLean [12], clearly established the validity of the reciprocity method for calibrating microphones.

In the United States, both cooperative and independent research subsequently included Cook at the National Bureau of Standards, Wiener and DiMattia at the Cruft Laboratory at Harvard University, and Olmstead and Hawley at the AT&T Bell Laboratories at Murray Hill, New Jersey [6,13]. The development of the Western Electric (WE) 640AA microphone [6,7] provided a stable modern microphone. Although no longer manufactured, the WE 640AA microphone still satisfies the specifications [14] for an IEC type LS1Po laboratory standard microphone, and numerous samples have met the specification in reference [14] for the long-term stability of a Type LS1P standard microphone (long-term drift in sensitivity level less than 0.02 dB/year). The newer WE 640AA microphones were used in inter-laboratory comparisons of calibration results among the laboratories of NBS, Harvard, and AT&T Bell. For each of the three microphones for which results were reported in 1945 [13], calibrations among the laboratories agreed within 0.2 dB at frequencies from 50 Hz to 9 kHz, typically somewhat better at frequencies below about 5 kHz, and within 0.3 dB over the frequency range 9 kHz to 11 kHz. These results demonstrated that measurements of sound pressure over a wide frequency range using stable standard microphones calibrated by the reciprocity method were superior to the use of the best available standard sources such as the thermophone.

This demonstrated superiority eventually led to the dominance of reciprocity methods as the primary calibration methods in acoustical laboratories of NMIs around the world. Modern pressure calibrations of microphones by reciprocity techniques are more accurate, more elaborate, and may use much more complex apparatus than Cook had available, but they are fundamentally similar.

In 1982, Cook's classic paper [1] was reprinted in its entirety in the *Benchmark Papers in Acoustics* series [4]. Assessing the contributions of various researchers, H. B. Miller [4, pp. 232-233] noted the significance of accomplishments represented in Ballantine's 1929 paper [15] and stated that an extract from this paper "is so similar to Schottky's work and so foreshadowing that of MacLean, that the wonder now is that Ballantine missed being the inventor of the absolute reciprocity calibration method. . . . Moreover, in his 1932 paper (Paper 25), Ballantine omitted all reference to the method, thereby presumably implying that he felt it had no future. . . . All the greater credit, surely, belongs to Cook and to

MacLean for having the courage to challenge the great prestige of Ballantine.” (Miller’s “Paper 25” is our reference [11]).

Cook’s introduction of the reciprocity method and his many other accomplishments were recognized in 1988 when the Acoustical Society of America awarded him its Gold Medal “. . . for outstanding seminal contributions to diverse areas of acoustics and to standardization.” [16].

Richard K. (RK) Cook was born in Chicago and obtained his B.S. in 1931, M.S. in 1932, and Ph.D. in 1935, all in the field of physics, from the University of Illinois. In 1935 he joined the National Bureau of Standards, and he spent most of his professional career there. He served as the Chief of the Sound Section from 1942 until 1966, where he contributed extensively to the technical literature on the subjects of microphones, microphone calibration, architectural and room acoustics, reverberation room characterization, piezoelectric properties of crystalline quartz and, eventually, the field of infrasonics. During these years, he also served as Associate Editor of *Sound* (1962-3), Senior Editor of the *Journal of the Washington Academy of Sciences* (1955), and Editor of the Acoustics section of the *American Institute of Physics Handbook*. In 1966 he left NBS temporarily to become Chief of the Geoacoustics Group in the National Oceanic and Atmospheric Administration, where he concentrated his technical talents on infrasonics. He returned to NBS in 1971 as a Special Assistant on Sound Programs, reporting to the NBS Director, and served in this capacity until his official retirement in 1976. After retirement, Cook acted as a consultant to NBS on acoustical matters.

Cook also held a number of teaching posts, instructing in mathematics for the U.S. Department of Agriculture Graduate School between 1941 and 1950 and in various courses in mathematics, physics, and engineering for the NBS Graduate School and Catholic University. He acted as Adjunct Professor in the Electrical Engineering Department of Brooklyn Polytechnic Institute in 1956 while on sabbatical from NBS and carrying out research at Bell Telephone Laboratories.

He is a Fellow of the Acoustical Society of America, the Washington Academy of Sciences, the American Physical Society, and the American Association for the Advancement of Science, and he served as President of the Acoustical Society of America in 1954-1955. Cook’s accomplishments span an extraordinary gamut of the subdivisions of acoustics, with respect to both physics and engineering, and they include exceptional service to technical societies, standards committees, and the body politic in general. Many people remember

RK’s involvement in their own particular fields, but he is truly a “Renaissance Man of Acoustics.”

Prepared by Victor Nedzelnitsky.

Bibliography

- [1] Richard K. Cook, Absolute Pressure Calibrations of Microphones, *J. Res. Natl. Bur. of Stand.* **25**, 489-505 (1940). Also in abbreviated form in Richard K. Cook, Absolute pressure calibration of microphones, *J. Acoust. Soc. Am.* **12**, 415-420 (1941).
- [2] *International Electrotechnical Vocabulary—Chapter 801: Acoustics and Electroacoustics*, IEC 60050-801 Ed. 2.0 t: 1994, International Electrotechnical Commission Central Office, Geneva (1994).
- [3] John William Strutt (Baron Rayleigh), *The Theory of Sound*, 2nd ed., Macmillan, London (1896) [reprinted Dover, New York, (1945)], Vol. II, Sec. 384.
- [4] Harry B. Miller (ed.), *Acoustical Measurements: Methods and Instrumentation*, Hutchinson Ross Publishing Company, Stroudsburg, PA (1982), Vol. 16 in *Benchmark Papers in Acoustics* (R. B. Lindsay, series ed.).
- [5] Leo Leroy Beranek, *Acoustical Measurements*, American Institute of Physics for the Acoustical Society of America, New York, (1988 Revised edition); (1949 edition published by John Wiley & Sons, New York).
- [6] R. K. Cook, A Short History of the Condenser Microphone, in *AIP Handbook of Condenser Microphones: Theory, Calibration, and Measurements*, G. S. K. Wong and T. F. W. Embleton (eds.), American Institute of Physics Press, New York (1995) pp. 3-7.
- [7] M. S. Hawley, F. F. Romanow, and J. E. Warren, The Western Electric 640AA Capacitance Microphone: Its History and Theory of Operation, in *AIP Handbook of Condenser Microphones: Theory, Calibration, and Measurements*, G. S. K. Wong and T. F. W. Embleton (eds.), American Institute of Physics Press, New York (1995) pp. 8-34.
- [8] G. B. Madella, Substitution Method for Calibrating a Microphone, *J. Acoust. Soc. Am.* **20**, 550-551 (1948).
- [9] E. C. Wente, A Condenser Transmitter as a Uniformly Sensitive Instrument for the Absolute Measurement of Sound Intensity, *Phys. Rev., Series II* **10**, 39-63 (1917).
- [10] E. C. Wente, The Sensitivity and Precision of the Electrostatic Transmitter for Measuring Sound Intensities, *Phys. Rev., Series II* **19**, 498-503 (1922).
- [11] Stuart Ballantine, Technique of Microphone Calibration, *J. Acoust. Soc. Am.* **3**, 319-360 (1932).
- [12] W. R. MacLean, Absolute Measurement of Sound Without a Primary Standard, *J. Acoust. Soc. Am.* **12**, 140-146 (1940).
- [13] A. L. DiMattia and F. M. Wiener, *On the Technique of Absolute Pressure Calibration of Condenser Microphones by the Reciprocity Method*, Harvard University Psycho-Acoustics Laboratory Report PNR-4 (1945).
- [14] *Measurement Microphones—Part 1: Specifications for Laboratory Standard Microphones*, IEC 61094-1 Ed. 1.0 b: 1992, International Electrotechnical Commission, Geneva (1992).
- [15] Stuart Ballantine, Reciprocity in Electromagnetic, Mechanical, Acoustical, and Interconnected Systems, *Proc. Inst. Radio Eng.* **17**, 929-951 (1929).
- [16] T. Proctor, Gold Medal Citation to Richard K. Cook, *J. Acoust. Soc. Am.* **83**, (Suppl. 1), S61 (1988).

Absolute Determination of the Ampere

Just before the outbreak of World War II, the International Committee on Weights and Measures (CIPM) began to consider moving from the existing international system of units to a so-called absolute system, the predecessor to the SI. In their first post-war meeting in October of 1946, the CIPM resolved to make that change on January 1, 1948. The decision was driven in large part by the results of a study by the National Bureau of Standards of absolute electrical experiments around the world (including our own), and recommendations for the ratios of the international electrical units to their absolute counterparts. These recommendations were based on averages of the results of determinations made in the United States and other countries. In this study, NBS contributed two results relevant to the determination of the ohm ratio and one determination of the ampere ratio. Since no absolute volt determination had been made, the volt ratio was computed from those of the ohm and ampere.

The paper *An Absolute Determination of the Ampere, using Helical and Spiral Coils* [1] gives one of the two NBS values that went into the 1948 redefinition of the ampere. It describes in detail the radically modified fixed and moving coils of the current balance; the measurements made on the coil dimensions; computations of their fields and interactions; and the force measurements relating current through a coil to the values of the national reference resistors and voltage standards of the time.

The final recommended value of the absolute ampere was constructed as the average of the results of three experiments, one from the National Physical Laboratory and two from NBS [1,2]. This evaluation also stood with that of the absolute ohm to provide the internationally accepted volt representation until 1969, when improved measurements and the use of the Josephson effect to determine the volt unit made a further change practical.

H. L. Curtis and R. W. Curtis published an earlier paper, *An Absolute Determination of the Ampere* [3], in 1934. This measurement used a Rayleigh current balance, in which the electromagnetic force between concentric coils is balanced by the gravitational force on a mass. By 1944, three absolute-ampere and three absolute-ohm experiments had been completed at the Bureau [4], and similarly accurate absolute determinations of the ampere and ohm were available from Britain.

Improved absolute measurements of current were in some ways more difficult than those of the ohm, and they proceeded by smaller steps. Before World War II, at about the same time that the moving-coil current balance was being used to determine the ohm, H. L. Curtis and R. W. Curtis had started to prepare a balance of a special design for the absolute ampere determination. In 1958 R. L. Driscoll reported results from this Pellat balance [5]. The mechanical measurement was of the torque on a small coil, with axis at right angle to the magnetic field of a large horizontal solenoid. When the current passing through the small coil was reversed, it produced a force that could be balanced by a mass of about 1.48 g placed on the balance arm. The large stationary coil was wound on a fused-silica form, and the balance beam was equipped with knife-edges and supports machined from natural agate. The effect of the measured dimensions of the small coil on the computed mutual inductance was the largest contribution to the uncertainty, which totaled about $8 \mu\text{A/A}$. Also contributing to the uncertainty were the determination of the balancing mass and the of the acceleration due to gravity.

As soon as possible after completing the Pellat balance measurement, Driscoll and Cutkosky [6] repeated the 1934 Rayleigh current-balance determination of the ampere using the original apparatus. The results of these two experiments, 1 NBS ampere = $(1.000\,013 \pm 0.000\,008)$ absolute amperes by the Pellat method, and 1 NBS ampere = $(1.000\,008 \pm 0.000\,006)$ absolute amperes by the current balance, were in good agreement. This gave an overall relative uncertainty in the ampere at NBS of about $5 \mu\text{A/A}$ at that time (1958) and verified that the ratio of emf to resistance of the maintained standards had been constant to within about one part in 10^5 since 1942.

Absolute experimental determinations of units are now known as SI realizations, and the uncertainty of the SI values of the electrical units are limited by the uncertainty of their realizations in terms of the kilogram, meter, and second. Results from the calculable capacitor experiment and other determinations of the fine-structure constant recently have been combined analytically [7] to yield a value of the von Klitzing constant R_K with a relative standard uncertainty of 4×10^{-9} . The Josephson constant K_J is based both on its direct measurement by voltage balances and by

combining R_K with a value of the Planck constant, the latter obtained by realizing the watt in a special way. This realization of the SI watt is achieved by the moving-coil watt balance, which is a modern version of the absolute ampere experiment.

The NIST watt balance has been designed to measure the ratio of mechanical to electrical power, linking the artifact kilogram, the meter, and the second to the practical realizations of the ohm and the volt derived from the quantum Hall effect (QHE) and the Josephson effect, respectively. The first results from the NIST watt experiment, sometimes called an ampere experiment, were published in 1989 [8], giving a relative standard uncertainty for K_J of 6.7×10^{-7} . That experiment was a prototype for the next version in which the magnetic field was increased a factor of 50 using a superconducting magnet, resulting in similar increases in the force and voltage. During the next decade many improvements were made [9,10]. In 1998 the latest results were published [11] by E. R. Williams, R. L. Steiner, D. B. Newell, and P. T. Olsen. That work, which used a NIST calculable capacitor measurement of R_K , reports that $K_J = 483\,597.892$ GHz/V with a relative standard uncertainty of 4.4×10^{-8} . This is the most accurate measurement of the Josephson constant to date.

The experiment is automated and runs nightly and over holidays to reduce vibrations. Recent measurements recorded 989 values of the SI watt over a 4-month period. The total uncertainty is dominated by Type B uncertainty components, that is, components that have to be evaluated by means other than statistical analysis of repeated measurements. Of the possible Type B error sources that contribute to the uncertainty, the three largest components arise from the following: (1) the index of refraction of air; (2) the present alignment procedures; and (3) residual knife-edge hysteresis effects during force measurements. Using the data discussed above, Williams *et al.* [11] obtained a relative standard uncertainty of $0.087 \mu\text{W/W}$.

By connecting the macroscopic unit of mass (the kilogram) to quantum standards based on the Josephson and quantum Hall effects, this result provides a significant improvement in the Josephson constant as well as many other constants. For example, recent measurements of the Planck constant h can be derived directly from this work with a relative standard uncertainty of 8.7×10^{-8} .

The NIST watt experiment is being completely rebuilt to reduce the uncertainty by a factor of ten, with a goal of less than 10 nW/W relative standard uncertainty. At that level of measurement uncertainty, the watt-balance experiment becomes a very good means of monitoring the mass artifact that is used in the weighings. The present definition of the unit of mass in the SI is based

on the International Prototype of the Kilogram, which is a cylinder of platinum-iridium housed at the BIPM in France. The Prototype and a set of duplicate standards of mass accumulate contaminants on their surfaces, and must be cleaned to achieve fractional changes over the long term of less than 10^{-8} per year. Since the kilogram is the last SI base unit defined in terms of a material artifact, a quantum standard of mass founded on electrical measurements would complete the modern trend of removing all artifacts from the definitions of SI units.

The largest uncertainties in the NIST watt experiment of the 1990s arose from operating in air, which required that the changing air buoyancy and refractive index be calculated from many readings of pressure, temperature, and humidity sensors. Almost every part of the balance assembly is being rebuilt to operate inside a specially constructed vacuum system consisting of two chambers, schematically represented in Fig. 1. The upper chamber houses the balance section, and a toroid-shaped chamber houses the inductive coils, located 3 m below and centered about the liquid helium cryostat containing the superconducting magnet.

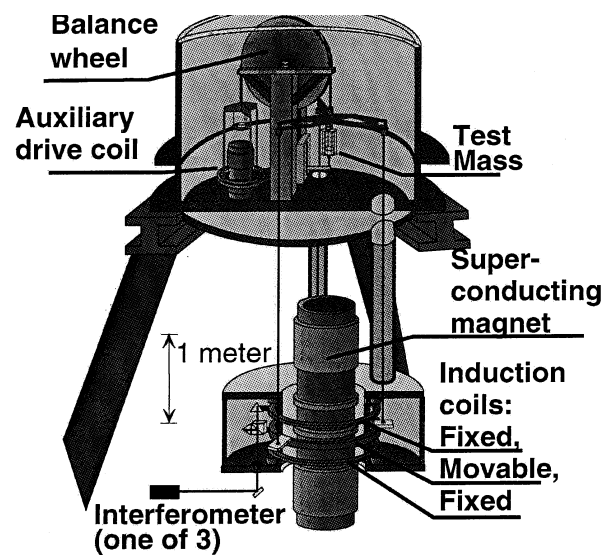

Fig. 1. Schematic representation of the electronic kilogram apparatus. The vacuum chamber and support tripod are shown in cut-away view.

Prepared by E. R. Williams, R. E. Elmquist, N. B. Belecki, and J. F. Mayo-Wells based on excerpts from the paper The Ampere and Electrical Units [12], authored by members of the Electricity Division.

Bibliography

- [1] Roger W. Curtis, Raymond L. Driscoll, and Charles L. Critchfield, An absolute determination of the ampere, using helical and spiral coils, *J. Res. Natl. Bur. Stand.* **28**, 133-157 (1942).
- [2] Harvey L. Curtis, Roger W. Curtis, and Charles L. Critchfield, An absolute determination of the ampere, using improved coils, *J. Res. Natl. Bur. Stand.* **22**, 485-517 (1939).
- [3] Harvey L. Curtis and R. W. Curtis, An absolute determination of the ampere, *Bur. Stand. J. Res.* **12**, 665-734 (1934).
- [4] Harvey L. Curtis, Review of recent absolute determinations of the ohm and the ampere, *J. Res. Natl. Bur. Stand.* **33**, 235-254 (1944).
- [5] R. L. Driscoll, Measurement of current with a Pellat-type electro-dynamometer, *J. Res. Natl. Bur. Stand.* **60**, 287-296 (1958).
- [6] R. L. Driscoll and R. D. Cutkosky, Measurement of current with the National Bureau of Standards current balance, *J. Res. Natl. Bur. Stand.* **60**, 297-305 (1958).
- [7] Peter J. Mohr and Barry N. Taylor, CODATA recommended values of the fundamental physical constants: 1998, *J. Phys. Chem. Ref. Data* **28**, 1713-1852 (1999); *Rev. Mod. Phys.* **72**, 351-495 (2000).
- [8] P. Thomas Olsen, Randolph E. Elmquist, William D. Phillips, Edwin R. Williams, George R. Jones, Jr., and Vincent E. Bower, A measurement of the NBS electrical watt in SI units, *IEEE Trans. Instrum. Meas.* **38**, 238-244 (1989).
- [9] Aaron D. Gillespie, Ken-ichi Fujii, David B. Newell, Paul T. Olsen, A. Picard, Richard L. Steiner, Gerard N. Stenbakken, and Edwin R. Williams, Alignment uncertainties of the NIST watt experiment, *IEEE Trans. Instrum. Meas.* **46**, 605-608 (1997).
- [10] Richard L. Steiner, David B. Newell, and Edwin R. Williams, A result from the NIST watt balance and an analysis of uncertainties, *IEEE Trans. Instrum. Meas.* **48**, 205-208 (1999).
- [11] Edwin R. Williams, Richard L. Steiner, David B. Newell, and Paul. T. Olsen, Accurate measurement of the Planck constant, *Phys. Rev. Lett.* **81**, 2404-2407 (1998).
- [12] R. E. Elmquist, M. E. Cage, Y-H. Tang, A-M. Jeffery, J. R. Kinard, R. F. Dziuba, N. M. Oldham, and E. R. Williams, The Ampere and Electrical Units, *J. Res. Natl. Inst. Stand. Technol.*, January-February (2001).

Radio Proximity Fuzes

Residents of the United States born much after 1930 can have little appreciation for what it was like to mobilize for total war. In World War II, everyone and every facet of daily life was affected. All citizens had to learn to live with food and fuel rationing, and no new cars or other consumer products made from steel could be purchased. There were blackouts, air raid drills, scrap drives, school children buying War Bonds (a 10 cent stamp at a time), and, of course, able-bodied men and women taken either into military service or placed in critical jobs in industry and elsewhere. Institutions such as the National Bureau of Standards were likewise totally involved in the war effort. The Bureau found itself with a number of very important technical assignments and, for a change, the resources to carry them out. In October 1939, after Albert Einstein and Leo Szilard urged the President to launch a major research program on the possibility of producing nuclear fission and

utilizing it in the likely war effort ahead, NBS Director Lyman Briggs was placed in charge of a new Advisory Committee on Uranium to look into this proposal. By 1941 some 90 % of the NBS staff was doing war work.

The Bureau worked on a great diversity of war projects ranging from high technology to evaluating materials for blackout curtains and blackout masks. A major effort carried out with the Navy and the Radiation Laboratory at MIT was the development and fielding of the Bat, the first combat success with a fully automatic guided missile (really a bomb with wings and a tail looking rather like a modern Unmanned Aerial Vehicle or UAV). The story of the Bat has significant technology in common with the proximity fuze program; namely, the use of electromagnetic radiation sources on flying ordnance and the interpretation and use of the reflected waves to carry out the mission.

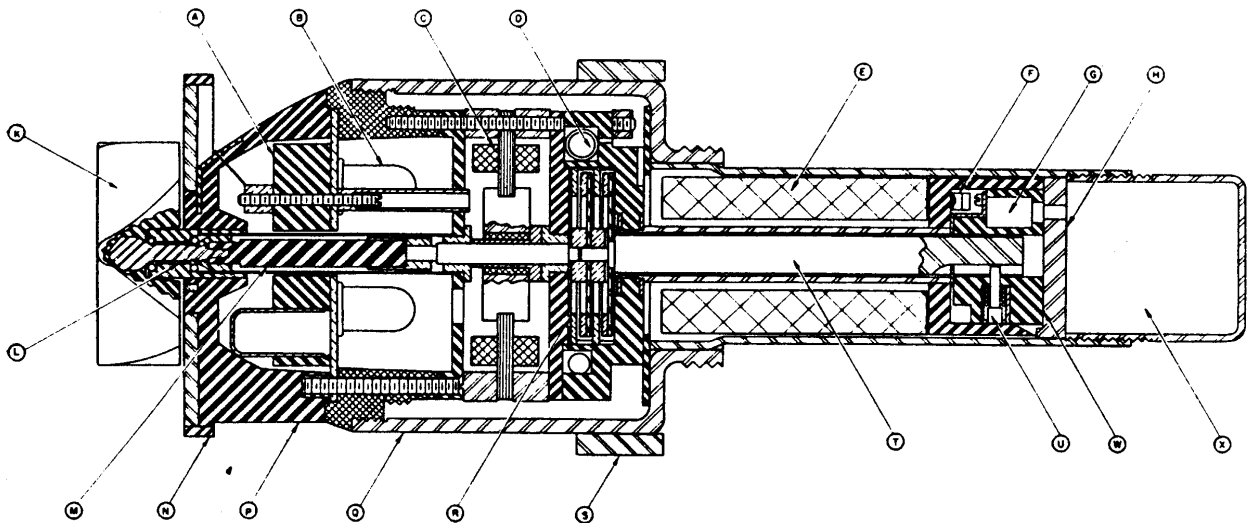

- | | | | |
|---|-----------------------|---|--|
| A | Oscillator block | N | Antenna (in later models, antenna extended forward to enclose vane) |
| B | Amplifier | P | Insulating support for antenna |
| C | Generator | Q | Fuze housing ("potato masher") |
| D | Rectifier | R | Speed reducing gears |
| E | Filter condenser | S | Lugs for wrench |
| F | Contacts to detonator | T | Low-speed drive shaft for arming mechanism |
| G | Detonator | U | Locking pin for detonator rotor |
| H | Tetryl plate | W | Detonator rotor (arming consists of rotation of this piece into proper position) |
| K | Windmill | X | Booster cup |
| L | Vane bearing assembly | | |
| M | Drive shaft | | |

Fig. 1. Sectionalized drawing of T-50 type bomb fuze. The same general arrangements of parts was used for all ring-type bomb fuzes (from [1]).

This is the atmosphere in which the Bureau undertook the work on proximity fuzes, work that had a profound impact on NBS for many years thereafter as well as providing the military with breakthrough applications of technology. Bureau staff at the end of World War II prepared the book titled *Radio Proximity Fuzes for Fin-Stabilized Missiles* [1]. It summarized all the work done from about 1940 through 1945. It is a monograph; that is, a stand-alone comprehensive presentation of the entire program. Allen Astin, then assistant chief of the Ordnance Development Division of the Bureau, edited the work. (Harry Diamond was chief; W. S. Hinman, Jr. was chief engineer.) The work was published under the auspices of the National Defense Research Committee (NDRC) and the Office of Scientific Research and Development (OSRD) and classified at the Secret level. It was declassified in 1960. The volume under discussion is one of three covering the work done by Division 4 of NDRC titled *Ordnance Accessories*. It should be pointed out that parts of the program were ably carried out by contracts with companies and universities, a mode of operation learned well in the war and likely very comfortable for the Bureau staff, given their history of collaborations with the private sector. It has been asserted that the radio proximity fuze effort consumed “about 25 % of the electronics manufacturing capacity and 75 % of the plastics molding capability” of the Nation during the war [2]. Authorship of the various chapters is by Bureau staffers who spent the war in the Ordnance Development Division and its subsequent subdivisions. Authors included such well-known names as Robert D. Huntoon, Chester Page, and Jacob Rabinow; Rabinow’s wife, Gladys, is listed as a contributor to one chapter.

The problem assigned to the Bureau was to conceive and realize a fuze system for non-rotating, fin-stabilized munitions (ordnance) such that detonation could be obtained at a specified distance from the target. Such performance is desirable for two reasons: first it is often difficult to produce a direct hit, and it is acceptable to achieve detonation close to the target. A good example is trying to hit an airplane or a rocket. A direct hit was well beyond the technology available in the 1940s and remains a challenge today for the anti-ballistic missile program. Secondly, more damage can often be obtained by detonation at some distance removed from the target. Air bursts over ground targets are effective over wider areas than explosions on the surface, where much of the energy goes to producing a crater. Air bursts are particularly effective against dug-in ground troops and against stored materiel. The ordnance addressed at NBS were rockets, bombs, and mortar shells. Both the Army and the Navy provided performance specifications for such fuzes and the program

came to the Bureau for execution. The specifications varied for the several applications, and the program was directed to make as much as possible common to all.

The first job was to select the basic concept. Although some thought was given to acoustic, photoelectric, and passive radio systems, an active radio scheme was adopted early on. As a result of the Bureau’s great successes with radio earlier and with radiosondes more recently, the choice of the radio scheme led directly to a major technical strength of NBS. Management could and did assemble a powerful team, largely from within but augmented by cooperation with the Navy and, at times, with our Allies in England. Radio waves could be employed by using time-of-flight measurements on the path from and reflected back to the ordnance in flight or by using the Doppler shift of the reflected radiation. The reflected waves are shifted to a somewhat higher frequency as the missile flies toward the target. Using the transmitting antenna as the receiving antenna, this reflected wave sets up a beat frequency in the oscillator circuit. Transmitting at 75 MHz to 110 MHz produced a beat frequency of a few hundred hertz, the exact value depending on the relative velocity of missile and target and the transmitting frequency. These details were considerably different for rockets, bombs, and mortar shells. Nonetheless the concept worked in all cases.

It turns out that this situation is equivalent to a time-varying impedance at the antenna terminals. The amplitude of this signal increases with the strength of the reflection; i.e., with decreasing distance to the target. By using the impedance, it is shown that the sensitivity to reflection is independent of power level over a wide range, thereby enabling application to many different systems. A variety of interferences are treated in detail in Chapter 2 of the book, including different antenna designs, ground effects, target geometry, and the like.

The differential signal from the antenna circuit was fed to an amplifier and, depending on the design, through a rectifying diode and thence to the grid of a thyratron. When this signal reached a set magnitude, the thyratron discharged into a detonator circuit and the fuze mission was complete. Details of the control circuit are in Chapter 3. The concept was first demonstrated in February 1941. What lay ahead was a long, painstaking series of engineering projects to put together a series of fuzes that not only detonated the munitions successfully, but also met the armed services requirements for safety, reliability, ease of manufacture, and shelf life. In addition, for most of the fuzes there was an additional requirement that they had to fit into existing fuze wells on existing ordnance. These practical considerations

were non-trivial and required considerable ingenuity. Few of the available electronic components were suitable. Industry was pressed into service to design and prove out new triodes, diodes, pentodes, thyratrons, and a variety of power supplies—an assignment carried out in a timely fashion. The mechanical systems such as safety designs and arming schemes, as well as alternate detonation systems for situations where the proximity fuze did not work for whatever reason, were described in Chapter 4.

Chapter 3 also addresses the question of providing electrical power to the circuits, both by batteries and by mechanical generators. The batteries were either ordinary dry cells or “reserve” types that were activated by the forces of launch wherein an ampoule containing the electrolyte was broken and the electrodes and electrolyte brought together. The “reserve” concept was demonstrated but not fielded; the idea would come to be used often years later when the technique had been perfected. Dry batteries were used in the early fuzes but suffered shelf life problems. Much effort was directed to the notion of a wind-driven turbine connected to a generator. This had safety advantages—no possibility of electric currents prior to flight—was fairly simple in design and manufacture, and proved to be the method of choice.

The remainder of the volume contains a catalog of fuze types, details of laboratory testing, details of field testing, a resume of actual performance at the latter stages of the war, and a formal analysis thereof. It is interesting to note the thoroughness of field testing as exemplified by the number of units tested: for bombs—15,000 dropped at Aberdeen Proving Ground in Maryland; for rockets fired from the ground—nearly 24,000 fired at Ft. Fisher in North Carolina and Blossom Point, Maryland (plus a few at Aberdeen); and some 3000 mortar shells fired at Blossom Point and the field station of the University of Iowa at Clinton, Iowa. Chapter 9 contains an analysis of performance. At the end of this chapter is a summary of conclusions by the armed services concerning results in combat.

Curiously, the driving force behind the work, Harry Diamond, seems not to have written any of the report. Nonetheless, he was the dominant figure throughout the war and established an atmosphere that made the great success possible. Diamond was a dynamo himself but evidently a very remarkable man to work for. He believed in delegation and a minimum of formality. Here is a quote from an appreciation written after his death [2]:

“It was a madhouse. I didn’t have a vacation during the entire war. Nobody knew who was in charge and nobody cared . . . they describe those days with tangible affection, even as ‘great fun’. . . . If someone needed help, they got help. If someone needed equipment, they got it. No questions asked. . . .”

The armed services’ comments are of special interest since they ensured the future post-war work at the NBS laboratories. Fuzes for rockets and bombs went into mass production and were used extensively toward the end of the war. Mortar shell fuzes did not go into full production. The conclusions from the services began with the following statement:

“The general attitude of the using arms to the bomb and rocket VT [proximity] fuzes at the end of World War II was most favorable. Originally there was much doubt as to their possible value as a lethal weapon. The general attitude was that the fuzes had very limited use, that they were unsafe, and that a high percentage of them malfunctioned. Combat experience in the various theaters changed this view, and with the close of World War II the using arms were very enthusiastic over the fuzes.”

Vannevar Bush is said to have considered the radio proximity fuze the preeminent scientific and technical advance of the war. Considering the Manhattan Project and radar, this is a startling statement. Another historian ranked the fuze as follows “Considering the magnitude and complexity of the effort [it ranks] among the three or four most extraordinary scientific achievements of the war.” General George Patton said, after the fuze had performed notably at the Battle of the Bulge, “The new shell with the funny fuze is devastating . . . I think that when all armies get this shell we will have to devise some new method of warfare.” [2].

Allen Astin, in his closing comment, stated that, as of 1946, the Army Ordnance Department had already formulated a further program and that the Ordnance Development Division at NBS was working for the Army on new fuze challenges.

It turned out that the NBS effort on fuzes continued in a very strong manner in the post war years and that military work came to dominate the work of the Bureau. The basic concept of using the Doppler shift in frequency of the reflected radiation and beating it against the transmitter’s oscillator frequency continued

to be used in these fuzes after the war. Ultimately the fuze systems became “first class radars” [3]. Technical work focused, inter alia, on security from jamming and thus involved various ways of disguising the signal. The reserve battery power supply was perfected and thermally-activated batteries became the method of choice. A quick perusal of the table of contents of an Army ordnance manual from 1963 shows major emphasis on continuous wave and pulsed Doppler fuzes. Eventually, of course, miniaturization through solid state and integrated circuits became possible. Technical director Horton marveled that the early fuzes using electron tubes were able to survive the stresses of launch.

The Kelly Committee, an ad hoc group, was formed by the NBS Visiting Committee and the National Academy of Sciences at the request of Commerce Secretary Sinclair Weeks after the uproar created by the AD-X2 battery additive controversy. The Committee report of 1953 recommended that the Bureau get back to its congressional charter and separate the bulk of its military work. Cochrane [4] says that 2000 staff were transferred to other agencies, some 1600 of these in three divisions that worked on fuzes. Those three divisions had earlier been placed in the Harry Diamond Ordnance Laboratory within NBS, the unit named in honor of the memory of Harry Diamond, who died at the early age of 48 years in 1948. The Army added the word “Fuze” (and dropped the “Harry”) to the title on receipt of the unit—thus, the Diamond Ordnance Fuze Laboratory, or DOFL. The remainder of the affected staff worked on guided missiles at a location in California and were shifted to the Navy. The DOFL remained at the Connecticut and Van Ness site until a new laboratory site could be completed in White Oak/Adelphi, Maryland. The move was carried out in 1973. This is just one of many examples of significant technical entities created out of the NBS over the years.

The DOFL had a distinguished history in the Army. It continued to work on fuzes although eventually turning over most of the work to various product development and engineering centers, such as Picatinny Arsenal and the Redstone Arsenal. The laboratory at Adelphi developed major research programs in high-power microwaves, electronics, nuclear simulation, radar, sensors, and signal processing—a broad, multi-program laboratory. In 1992 it became one of the major components of the new Army Research Laboratory and the Adelphi site served as the new entity’s headquarters. The central building in the complex carries prominently on its façade the name “Harry Diamond Building.”

Inside are portraits of Diamond and Hinman and displays of the early fuze artifacts and documents. In a curious coincidence John Lyons, ninth director of NBS/NIST, became, in 1993, the first director of the new Army Research Laboratory and made his offices in the Harry Diamond Building. In a sense he felt he had simply moved to one of the Bureau’s more significant descendants. He served ARL as its director through 1998, when he retired.

Allen Astin went on to become the fifth director of NBS and served the second longest tour of any director— from 1952 to 1969. Diamond died shortly after the war; his close associate, W.S. Hinman, Jr., succeeded Diamond as head of the program and became the first technical director of the DOFL after it moved to the Army. After staying with the DOFL for a few years, Hinman moved on to become the Deputy Assistant Secretary of the Army (Research & Development). Robert Huntoon served as a senior manager at NBS heading atomic and radiation physics. He later became Associate Director of NBS for Physics and, still later, Deputy Director as well. J. Rabinow had a distinguished career as an inventor and innovator, left NBS to form a company which he later sold to Control Data. He returned to NBS and served in various senior capacities and was at work at least part-time until his death in 1999 at the age of 89. Chester Page went on to head the Electricity Division for many years and made many contributions, not least of which were his efforts in developing the concepts that became the international system of units of measurement (SI).

Prepared by John W. Lyons with assistance from E. A. Brown and B. Fonoroff (ret.) of the Army Research Laboratory.

Bibliography

- [1] Allen V. Astin (ed.), *Radio Proximity Fuzes for Fin-Stabilized Missiles*, Vol. 1 of Summary Technical Report of Division 4, NDRC, Vol. 1, National Defense Research Committee, Washington, DC (1946).
- [2] N. R. Kellog, *I’m Only Mr. Diamond*, biographical essay, U.S. Army Laboratory Command, Army Materiel Command, Adelphi, Maryland (1990).
- [3] Private conversation in February 2000 with Billy Horton, retired technical director at the Army’s Adelphi, Maryland laboratories.
- [4] Rexmond C. Cochrane, *Measures for Progress. A History of the National Bureau of Standards*, NBS Miscellaneous Publication 275, U.S. Government Printing Office, Washington, DC (1966) p. 497.

Stability of Double-Walled Manganin Resistors

The resistance standard described by James L. Thomas [1] was the result of his extensive effort to develop a new standard by systematically investigating every factor affecting the stability of resistance—time, surface effects, temperature, power, pressure—detectable at the time. The result was a unique standard which was used as part of the National Reference Group of resistors beginning in 1931. Ten of them served solely as the U.S. standard of resistance from 1939 until they were supplanted by the quantized Hall effect (QHE) in 1990. They still serve as working standards at the one ohm level and as a vital check on the QHE standard and the scaling used in the NIST resistance calibration service. The International Bureau of Weights and Measures used this standard to maintain the international unit of resistance, and numerous other national standardizing laboratories around the world used it as their primary standard. This is still largely true for laboratories without QHE standards.

In the period from 1935 to 1980, Thomas's standard provided a basis for evaluating the accuracy of ohm determinations, particularly to compare realizations based on calculable inductors with those based on Thompson-Lampard calculable capacitors. Thomas's standard was commercialized by the Leeds and Northrup Company and Honeywell, and these commercial versions are still used as primary resistance standards by many industrial and commercial standards laboratories, as well as the DOD primary and secondary metrology laboratories. NIST still routinely calibrates about 125 of them annually for domestic users. Thomas's standard remains the most stable resistor of any available, although two more modern designs are nearly a match in predictability.

Much of the research leading to this standard resistor design is described in an earlier paper by Thomas [2]. However, the paper *Stability of Double-walled Manganin Resistors* [1] is the more popularly known and describes the standard in its final form, after some major modifications in size and connections.

In the 1920s, Thomas had taken up the task of improving the long-term stability of wire-wound resistors, which were used to measure the current in absolute determinations. When a resistor is made by winding wire on a spool, parts of the crystalline structure of the wire are stressed past their elastic limit. Thomas developed wire-wound standard resistors that were annealed at high temperature, which released some of the internal

strains and reduced the rate of change of resistance with time. Heat-treated manganin wire resistors developed by Thomas incorporated hermetically-sealed, double-walled enclosures, with the resistance element in thermal contact with the inner wall of the container to improve heat dissipation. These 1 Ω Thomas-type standards (see Fig. 1) proved to be quite stable with time [1,2], and quickly came into favor as the primary reference for maintaining the resistance unit at NBS and at many other national metrology institutes.

Work continued on improving the absolute measurements of electrical units and, in 1949, J. L. Thomas, C. L. Peterson, I. L. Cooter, and F. R. Kotter published a new measurement of the absolute ohm [3] using an inductor housed in a non-magnetic environment. Using the Wenner method of measuring a resistance in terms of a mutual inductance and a rate of rotation, their work gave a value of 0.999 994 absolute ohm for the new as-maintained unit of resistance at NBS. The mean value assigned to 10 Thomas-type standard resistors from this experiment was found to have been the same between 1938 and 1948 to within 1 $\mu\Omega/\Omega$. As Thomas *et al.* wrote in the 1949 paper, this was “the first satisfactory method that has been devised for checking the stability of the unit as maintained by a group of wire-wound resistors.”

From 1901 to 1990, the U.S. Legal Ohm was maintained at 1 Ω by selected groups of manganin resistance standards. Four different types of resistance standards have been represented in these groups, whose numbers have varied from 5 to 17 resistors. From 1901 to 1909, the group comprised Reichsanstalt-type resistance standards made by the Otto Wolff firm in Berlin. These standards were not hermetically sealed and consequently underwent changes in resistance as a function of atmospheric humidity. In 1907 Rosa at NBS solved the problem by developing a standard whose resistance element is sealed in a can filled with mineral oil [4]. The U.S. representation of the ohm was maintained by 10 Rosa-type 1 Ω resistance standards from 1909 to 1930. Over the years, measurements of differences between the individual Rosa-type resistors indicated that the group mean was probably not constant. In 1930, Thomas reported on the development of his new design for a resistance standard having improved stability [2]. The Thomas resistance standards were more stable immediately following construction than the Rosa-type resistors and two were added to the



Fig. 1. A double-walled 1 Ω standard resistor of the Thomas type.

primary group in 1930. Eventually, in 1932, the Rosa-type resistors in the primary group were replaced by the Thomas resistors. To reduce loading errors, Thomas in 1933 improved the design of his resistor by using manganin wire of larger diameter mounted on a larger diameter cylinder to increase the dissipation surface area, as described in his paper [1]. A select group of the new-design Thomas resistors was used to maintain the U.S. Legal Ohm from 1939 until its re-definition in 1990 based on the quantum Hall effect.

The value of the U.S. representation of the ohm, or “Legal Ohm” maintained at NIST has been adjusted only twice. This occurred first in 1948 when the ohm was reassigned using a conversion factor relating the international reproducible system of units [3] to the precursor of the International System of Units (SI) derived from the fundamental units of length, mass, and time. The second occasion was in 1990 when the ohm became based on the quantum Hall effect. After 1960, ohm determinations were made using calculable capacitors based on the Thompson-Lampard theorem and a sequence of ac and dc bridges. Then came the discovery of the QHE in 1980, which has provided an invariable standard of resistance based on fundamental constants. Consequently, on January 1, 1990 the U.S. Legal Ohm was re-defined in terms of the QHE, with the internationally-accepted value of the quantum Hall resistance (or von Klitzing constant, after the effect’s discoverer) based on calculable capacitor experiments and other fundamental constant determinations. At that time, the value of the U.S. Legal Ohm was increased by the fractional amount 1.69×10^{-6} to be consistent with the conventional value of the von Klitzing constant [5].

Shortly after the discovery of the QHE, NBS developed a system based on the QHE to monitor the U.S. Legal Ohm, then maintained by five Thomas-type resistance standards, with a relative uncertainty of a few times 10^{-8} [6]. This system consisted of a constant current source, a potentiometer, and an electronic detector. The current source energized the QHE device and a series-connected reference resistor of nominal value equal to the Quantum Hall Resistance (QHR). With the potentiometer balancing out the nominal voltage across either resistance, the detector measured the small voltage difference between the QHE device and reference resistor. Scaling down to the 1 Ω level was accomplished using specially-constructed Hamon transfer standards.

Since January 1, 1990, the maintenance of the U.S. Legal Ohm has been based officially on the QHE. However, the complexity of the experiment and “odd-value” resistance of the QHR does not make it practical for the routine support of resistance measurements where comparisons are normally made on standard resistors of nominal decade values. Therefore, banks of 1 Ω , 100 Ω , and 10 k Ω standard resistors maintain the ohm between QHR measurements.

Today NIST provides a calibration service for standard resistors of nominal decade values from 10^{-4} Ω to 10^{14} Ω . To achieve low uncertainties, eight measurement systems have been developed that are optimized for the various resistance levels [7]. Over the years from 1982 to 1997, six of the systems, covering the full 19 decades of resistance, have been automated. The main methods of comparing standard resistors for NIST calibrations

utilize direct current comparator (DCC) bridges and resistance-ratio bridges.

An unknown standard resistor is indirectly compared to a reference bank of the same nominal value using the substitution technique, where the unknown and reference resistors are sequentially substituted in the same position of a bridge circuit. A robotic switching device is shown in Fig. 2. This technique tends to cancel errors caused by ratio non-linearity, leakage currents, and lead and contact resistances. To verify that the values of the reference banks are consistent with the QHR, scaling

measurements are completed periodically proceeding from the 1 Ω , 100 Ω or 10 k Ω banks, whose values are based on recent QHR determinations, to the other reference banks. The up or down scaling is done in steps of 10 or 100 using either a CCC bridge, Hamon transfer standards, or DCC bridge.

Prepared by R. Dziuba, N. B. Belecki, and J. F. Mayo-Wells based on excerpts from the paper The Ampere and Electrical Units [8], authored by members of the Electricity Division.

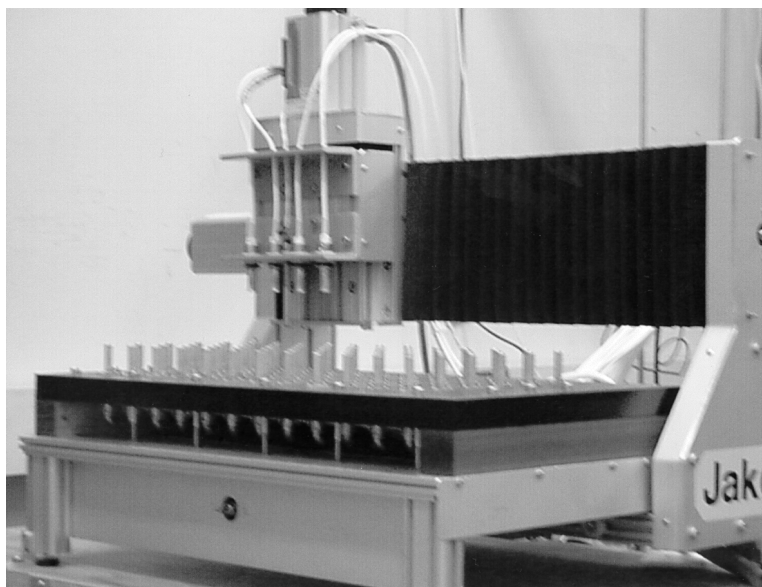

Fig. 2. Photograph of a programmable guarded switching system used in calibrating customers' resistors. The robotic translation stage moves in three axes to accomplish its switching function and has whimsically been named "jake."

Bibliography

- [1] James L. Thomas, Stability of Double-walled Manganin Resistors, *J. Res. Natl. Bur. Stand.* **36**, 107-110 (1946).
- [2] James L. Thomas, A new design of precision resistance standard, *Bur. Stand. J. Res.* **5**, 295-304 (1930).
- [3] James L. Thomas, Chester Peterson, Irvin L. Cooter, and F. Ralph Kotter, An absolute measurement of resistance by the Wenner method, *J. Res. Natl. Bur. Stand.* **43**, 291-353 (1949).
- [4] Edward B. Rosa, A new form of standard resistance, *Bull. Bur. Stand.* **5**, 413-434 (1909).
- [5] Norman B. Belecki, Ronald F. Dziuba, Bruce F. Field, and Barry N. Taylor, *Guidelines for Implementing the New Representations of the Volt and Ohm Effective January 1, 1990*, NIST Technical Note 1263, National Institute of Standards and Technology, Gaithersburg, MD (1989).
- [6] Marvin E. Cage, Ronald F. Dziuba, and Bruce F. Field, A test of the quantum Hall effect as a resistance standard, *IEEE Trans. Instrum. Meas.* **IM-34**, 301-303 (1985).
- [7] Ronald F. Dziuba, Paul A. Boynton, Randolph E. Elmquist, Dean G. Jarrett, Theodore M. Moore, and Jack D. Neal, *NIST Measurement Service for DC Standard Resistors*, NIST Technical Note 1298, National Institute of Standards and Technology, Gaithersburg, MD (1992).
- [8] R. E. Elmquist, M. E. Cage, Y-H. Tang, A-M. Jeffery, J. R. Kinard, R. F. Dziuba, N. M. Oldham, and E. R. Williams, The Ampere and Electrical Units, *J. Res. Natl. Inst. Stand. Technol.*, January-February (2001).

Manufacture of Paper for War Maps and Other Applications

The manufacture of robust paper for maps assumed great importance early in World War II. Up to that time, maps used by troops in combat tended to disintegrate rapidly after being subjected to the water, mud, and grime of the battlefield. On the basis of information developed by the NBS Paper Section, the Army Map Service of the Corps of Engineers formulated specifications for paper for the printing of maps. The most critical requirements were very high resistance to tear, high wet tensile strength, high dry tensile strength, high opacity, and superior smoothness. Additionally, the paper needed to be made from commercially available raw materials to meet unprecedented tonnage requirements. The article *Experimental Manufacture of Paper for War Maps* [1] documents the contributions of NBS to this endeavor.

In the NBS Paper Section, this project was spearheaded by Charles G. Weber and Merle B. Shaw. They attacked the problem by preparing many batches of paper under a variety of experimental conditions on a “Fourdrinier” semi-commercial paper-making machine. This machine, invented by Nicholas Robert in France and named after the Fourdrinier brothers in England who commercialized it in 1804, is basically an endless wire screen belt which runs continuously; a paper pulp suspension flows onto the screen at one end and is removed at the opposite end after most of the water has been removed. The partially dried suspension is transferred onto a felt and transported over drying cylinders. A simple Fourdrinier travels at a speed of less than one mile per hour, but a modern, highly automated machine can travel 30 times as fast.

One of the variables tested by NBS was the relative amount of cutting and fraying, which affect fiber strength. These variables are a function of “beating,” a process in which an aqueous suspension of paper pulp is passed continuously between a revolving roll and a bedplate. Knives are installed on the roll and initially separated from the bedplate by about 2.5 mm. Operating the beater with a wide bedplate-to-roll separation frays the fibers, with little cutting, and generates a large surface area. Operation with the roll close to the bedplate produces more cutting and less fraying.

In the early 1940s, it was common practice to permit extensive fraying of fibers as this produced a large surface area for fiber-to-fiber bonding and thus a very strong paper. When a papermaker held the paper up to

the light, his product looked very uniform, and this had become a simple test for paper quality. However, because of extensive fiber-to-fiber bonding, this paper had a high coefficient of hygroscopic expansion, an undesirable property for military maps. Shaw and Weber found that the recently developed melamine resin could be used as a bonding agent to increase wet strength, and that the resin could take the place of beating to increase dry strength. The reduced need for beating diminished the interfiber bonding and consequently the hygroscopic expansivity of the sheet. At first, paper makers objected to the disordered or “wild” appearance when the paper was viewed by transmitted light, as described above. Once it was recognized that the disordered appearance was not a criterion for the quality of map paper, this test was discarded.

With the assistance of NBS . . . production (of paper for war maps) exceeding 5000 tons per month was achieved within 6 months. This was a substantial contribution to the war effort.

Ultimately, numerous runs on the Fourdrinier showed that the best paper was obtained by using 100 % strong bleached sulfate pulps with the addition of melamine-formaldehyde resin to increase wet strength, and titanium dioxide to produce the desired opacity [1]. The large scale of the Fourdrinier in the Paper Section facilitated the transfer of this technology to factory production. With the assistance of NBS, many paper mills were able to meet or exceed the specification prepared by the Army Map Service. Production exceeding 5000 tons per month was achieved within 6 months. This was a substantial contribution to the war effort.

Further studies on paper for defense needs continued after World War II. About 1952 the Naval Research Laboratory and the NBS Paper Section cooperated in the development of the first machine-made paper made from glass fiber, without binder or additives [2]. The paper, which resembles soft blotting paper, was found to have numerous important applications, both in defense

and civilian life. It was many times more effective as an air filter than commercial filters then on the market. It was found to be a very effective smoke filter in gas masks. All-glass paper is resistant to heat, moisture, chemicals, and microorganisms, and it has excellent electrical properties. It was used in diverse applications, such as mine respirators, gas masks, and filter discs for laboratory crucibles.

The first all-glass paper had a low tensile strength, and thus required extra care in production, storage, and handling. A 1955 study showed that the best bonding was obtained if the beater was maintained at 85 °F and a pH within the range 3.0 to 4.0. Under these conditions the fibers were well dispersed, resulting in a uniform sheet of paper. The secret of the interfiber bonding and the strength of fiberglass paper lies in the reaction of the glass fiber with acid [3]. Most acids react so slowly with glass under normal conditions that there is negligible effect. However, very fine glass fibers expose a very large surface area to the acid, which starts to dissolve the soda and the lime in the glass, leaving on its surface a thin gelatinous layer, rich in silica. When the fibers are pressed together in the papermaking process, this gelatinous layer acts as an adhesive to bond the fibers. Although the pH must be below 4.0 to obtain this effect, the pH of the paper becomes neutral after the acid solution drains from the paper.

Research on paper for currency has been another important NBS contribution. The first work at NBS on currency paper, supported by the Bureau of Engraving and Printing, was initiated in 1924 and conducted by Merle B. Shaw and George W. Bicking [4]. Paper currency had to be redeemed after a few months of circulation, and at that time the cost was substantial. Shaw and Bicking developed a paper that was about twice as strong as the paper then used for printing currency. The wear-resistant quality of paper currency was very much increased.

Until 1957, currency had been printed on flat-bed presses on moist paper, but this process was too slow for the expanding currency needs. New high-speed rotary presses were obtained, and the Paper Section developed a new paper for use in these presses. This new paper was 75 % cotton and 25 % linen with melamine resin, glue, and glycerol as additives, and it was printed dry. On Oct. 5, 1957, the first dollar notes printed on the new paper by the new high-speed rotary intaglio presses using the dry-print method were placed in circulation. A statistical evaluation, made by John Mandel of the NBS Statistical Engineering Laboratory [5], showed the old bills had a median life of approximately 122 days, while that of the new bills was approximately 172 days. This was indeed a substantial improvement of an undeniably short lifetime. The

manufacture of currency paper, within the guidelines developed by the NBS Paper Section, has saved the U.S. Government millions of dollars.

Over the years, the Paper Section's standards-related work consisted of (1) the development of methods for evaluating the chemical and physical properties of paper, (2) the development and evaluation of testing machines, especially for active projects, and (3) the statistical evaluation of test procedures. Where possible, the work was directed toward the preparation of test methods for the Technical Association of the Pulp and Paper Industry (TAPPI) or for the American Society for Testing and Materials (ASTM). This effort continued throughout the lifetime of the section, culminating in the establishment of a Collaborative Testing Program in 1969, mostly through the initiative of Theodore Lashof. Paper samples were distributed to participating laboratories, test results were obtained, and data returned to the NBS for analysis. A report was prepared by NBS and distributed to the participating laboratories. Through this program, cooperating laboratories could compare their results with those of other laboratories and, thereby, evaluate their own testing equipment, personnel, or laboratory conditions [6]. Eventually, the great growth of this program necessitated that it be shifted to the private sector. Collaborative Testing Services, Inc., assumed responsibility for the program, which now includes many other materials in addition to paper. Laboratories all over the world participate in this activity.

The NBS Paper Section also has a long history of contributions to the development of standards for permanent record paper and other contributions to the science of preservation of records. In 1929, at the request of the American Library Association and with the support of the Carnegie Foundation, the Paper Section implemented a study of the whole problem of preservation of records. The National Archives, created in 1934, later supplied the principal support, along with the Department of Agriculture, the Social Security Board, and manufacturers of record materials.

We know today that a calcium carbonate filler in paper almost guarantees long-term stability. Although the use of calcium carbonate filler started in 1901, almost 40 years passed before its advantages were recognized. In the 1930s, M. B. Shaw and M. J. O'Leary of the Paper Mill at NBS made 72 papers on the experimental Fourdrinier in a study of sizing and filler materials on the stability of paper. Several papers with an alkaline filler were included in the study at the suggestion of Edwin Sutermeister, who was on the advisory committee for the project. This study showed that the stability of paper was an inverse function of

acidity and thus depended on alum content. An alkaline filler gave paper maximum stability [7]. Unfortunately, conventional rosin-alum sizing was not efficient in an alkaline medium, so the process was not favorably received until an alkaline sizing material was developed in the early fifties. When fiber gradually increased in price to the point where calcium carbonate filler was cheaper than fiber, alkaline paper gained wide acceptance. The percentage of alkaline paper on the market has increased in the last 20 years from a few percent to more than 80 %.

In the early 1940s the Library of Congress asked NBS for recommendations for the display of the Charters of Freedom—the Declaration of Independence, the Constitution, and the Bill of Rights. Herbert F. Launer, who had done careful studies of the effect of light on paper [8], suggested an atmosphere of helium in a sealed enclosure at 25 % to 35 % relative humidity, with a light filter that cut off at a wavelength of about 450 nm. These suggestions were followed when the documents were enclosed for display [9]. Work on the preservation of records after 1954 was supported by the National Archives and Records Administration. As NARA was interested in standards, the Paper Section worked with the ASTM to develop six standards for papers suited to permanent record storage [10].

Thus the contributions of the NBS Paper section spanned a wide range of military and civilian applications. In conducting this work, the group identified significant national needs, worked with other government agencies and industry to meet those needs in a

cost-effective way, and participated in the development of essential test methods and specifications.

Prepared by William K. Wilson.

Bibliography

- [1] Charles G. Weber and Merle B. Shaw, Experimental Manufacture of Paper for War Maps, *J. Res. Natl. Bur. Stand.* **37**, 325-330 (1946).
- [2] M. J. O'Leary, B. W. Scribner, J. K. Missimer and J. J. Erving, Manufacture of Paper from Glass Fibers, *Tappi* **35**, 289-293 (1952).
- [3] M. J. O'Leary, R. B. Hobbs, J. K. Missimer and J. J. Erving, Effects of Mechanical Preparation and pH on the Strength of Glass-fiber Paper, *Tappi* **37**, 446-450 (1954).
- [4] Merle B. Shaw and George W. Bicking, Research on the Production of Currency Paper in the Bureau of Standards Experimental Paper Mill, *Technol. Pap. Bur. Stand.* **21**, 89-108 (1926).
- [5] E. B. Randall, Jr. and John Mandel, A Statistical Comparison of the Wearing Characteristics of Two Types of Dollar Notes, *Mater. Res. Stand.* **2**, 17-20 (1962).
- [6] T. W. Lashof, The NBS-TAPPI Collaborative Reference Program—beginning its second decade, *Tappi* **63** (4), 61-63 (1980).
- [7] M. B. Shaw and M. J. O'Leary, Effect of Filling and Sizing Materials on Stability of Book Papers, *J. Res. Natl. Bur. Stand.* **21**, 671-695 (1938).
- [8] H. F. Launer and W. K. Wilson, Photochemical Stability of Papers, *J. Res. Natl. Bur. Stand.* **30**, 55-74 (1943).
- [9] *Preservation of the Declaration of Independence and the Constitution of the United States*, NBS Circular 505, National Bureau of Standards, Washington, DC (1951).
- [10] Six standards for paper for permanent records, *Annual Book of ASTM Standards*, No. 15.09, American Society for Testing and Materials, West Conshohocken, PA (1999).

Transmission of Sound Waves in Gases at Low Pressures

Midway through World War II it became apparent that a better understanding of the motion and interaction of gaseous media with solid objects was needed. As aircraft flew at higher altitudes, approaching the speed of sound, strange shock wave effects interrupted normal flight. Propulsion mechanisms became challenged by the rapid increases in frictional drag. At the same time, the fledgling nuclear industry was trying to accelerate ion plasmas to higher speeds and energies, where confinement and wall heating were serious issues. The normal kinetic theory of gases was inadequate to describe these additional complex actions originating from the frictional and viscous forces of real compressive fluids. Two different parts of this problem existed. They are identified as nonlinearity, which occurs at high speeds, and *nonuniformity*, which is the behavior of the mechanics of rarefied gases.

Greenspan [1] described this behavior in the following way. “Nonuniform effects in gases are best studied at small acoustic amplitudes where relaxation effects can be observed. From kinetic-theoretical considerations in a gas of smooth rigid spheres, the speed of sound depends only on the mean speed of the molecules, provided that the gas is sufficiently dilute so that practically all of the molecular momentum is transferred and that the mean collision rate is very high. Laplace’s formula states that the sound speed depends on the molecular mass and the temperature, and these determine the molecular speed. Any dispersion must depend on the ratio of collision rate to sound frequency. A suitable parameter for comparison is one proportional to this ratio (pressure/frequency). For example, a sound wave at an audio frequency of some kHz in a gas near atmospheric temperature and pressures will have a mean collision rate of order of 10^{10} s^{-1} . The medium is very fine grain and the dispersion is negligible. As the sound frequency is steadily increased, the frequency becomes comparable at first to the collision rate of the slower molecules. The collision rates becomes positive correlated with the molecular speed. The slower molecules can not transfer the acoustic momentum coherently, and this burden shifts to the faster molecules. Accordingly, the speed of sound steadily increases with frequency. The effect is negligible unless the frequency is very high.”

In 1845 Stokes had first considered the effect of viscosity of gases on the propagation of sound. Since then, several approximations to the Boltzmann theory were developed to describe the action of frictional and viscous forces that affect gas dynamics. No singular closed solution exists that covers all cases of a rarefied or high speed gas. Some of the best known approximations are attributed to Stokes-Navier (1st order) and Burnett (2nd order). In the mid 1940s, experimental confirmation for these approximations was pursued using shock wave experiments. However, this technique cannot separate the combined effects of two distinct behaviors of gases, nonlinearity and nonuniformity. One way to make this separation is to use the small displacement condition of ultrasonic wave propagation to determine the nonuniformity behavior of the gas in the absence of any nonlinear effects.

The first endeavor that Martin Greenspan undertook after he began research in ultrasonics in 1946 was the investigation of the effects of gas viscosity on the acoustic propagation constant. At the suggestion of R. K. Cook, then Chief of the NBS Sound Section, “Moe” began the construction of an ultrasonic interferometer and necessary related gas control equipment. The first element of research was to measure the attenuation of sound as a function of pressure in rarefied helium at 1 MHz. This resulted in a paper describing the attenuation [2] over a pressure range of 0.5 kPa to 4 kPa and a comparison of the results to the Kirchhoff (Stokes-Navier) approximation.

This was the first of a succession of research projects; starting with attenuation measurements for sound waves in several rarefied monatomic gases and eventually continuing to diatomic gases. This research program covered a 14-year period and resulted in eight archival publications, two of which were review treatises of great significance [1-8].

Shortly after this first paper, Greenspan recognized the inadequacy of the theoretical explanation for the deviation of the gas behavior from the classic theory. He extended this work for the propagation of sound in diatomic gases. At the time, no theory for the behavior of more complex gas molecules existed. Greenspan extended the existing theory to cover both translational and thermal relaxational dispersions of sound energy

[5, 7]. He adapted a Stokes-Kirchhoff (S-K) function to represent a diatomic gas by converting the conventional S-K function into a dimensionless equation. This equation is described by two main variables: normalized viscosity and normalized thermal conductivity. The equation can be solved by eliminating the normalized thermal conductivity, but the solution is very formidable. However, an approximate solution can be obtained by factoring the standard S-K function into two parts; one associated with a sound wave and the other related to a heat wave. Under special values of γ , the ratio of specific heats, this relationship compares very favorably to the more exact solution. For the thermal relaxational part, Moe chose a relationship developed by Hertzfeld and Rice. He combined the translational and the thermal relaxation descriptions in a manner that produced two equations, a propagational one and an attenuative one.

After his first experimental effort, the ultrasonic interferometer was improved in several ways. The device was redesigned as a double crystal interferometer with constant gas volume that allowed the interferometer to operate in a nonresonant condition. This suppressed the transverse modes. New transducers were selected to run at the higher frequency of 11 MHz, improving the resolution greatly. Also, the measuring equipment was automated to measure continuously both the propagation constant (sound speed) and frictional component (attenuation) [4].

With the new equipment, Greenspan revisited the case of helium [3]. He compared the measured attenu-

ation and speed of sound to the predictions of both the Stokes-Navier and the Burnett theories. He demonstrated how the measured data deviated from these theories at pressures below 0.5 kPa. Fig. 1 compares the real part α and the imaginary part β of the propagation constant for helium with computed functions of three approximate theories: Stokes-Navier, Burnett, and Super Burnett (Super Burnett theory is a separate approximation of higher order). The parameters shown on Figure 1 are: $\beta = \omega/c$, $\alpha =$ amplitude attenuation, $\omega = 2\pi f$, c is speed of sound at the frequency f , and p is the dynamic pressure. These variables are normalized to $\beta_0 = \omega/c_0$, the low frequency value. For comparison, Moe selected an independent variable that was proportional to the ratio pressure/frequency. This variable, r , is the traditional Reynold's number divided by γ and is used in place of gas pressure alone because it is a normalizing factor.

The next project was to measure sound speed and attenuation in four rarefied monatomic gases (neon, argon, krypton, xenon) [5]. When compared through the independent variable r all of the data for the individual monatomic gases collapse onto the same functional relationship. Again, Moe demonstrated the regions of agreement between the measurements and the various theories and identified the region where the measurements deviated significantly. The results show that simple monatomic gases can display sound dispersion associated with normal gas viscosity. Some representative results of these measurements on the five monatomic gases are shown in Fig. 2, which compares

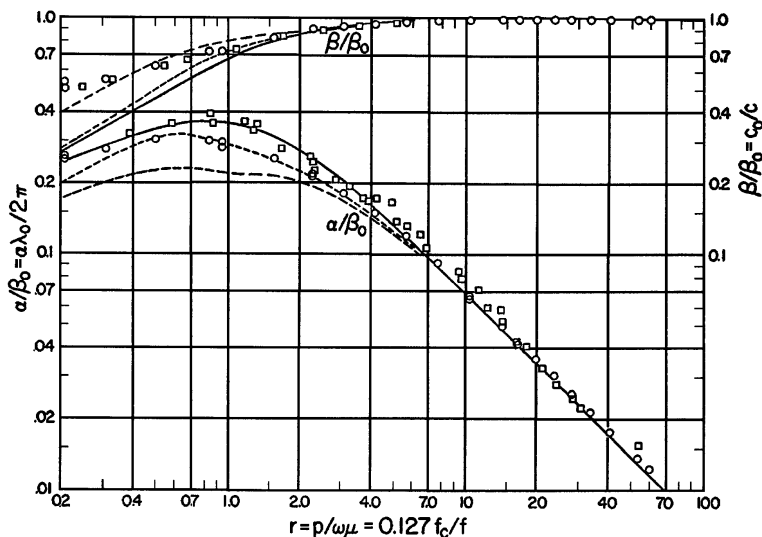

Fig. 1. Helium propagation constant as a function of r . Solid line: Stokes-Navier. Short dashed line: Burnett. Longer dashed line: Super Burnett. Circles: measurements at 11 MHz. Squares: previous measurements at 1 MHz.

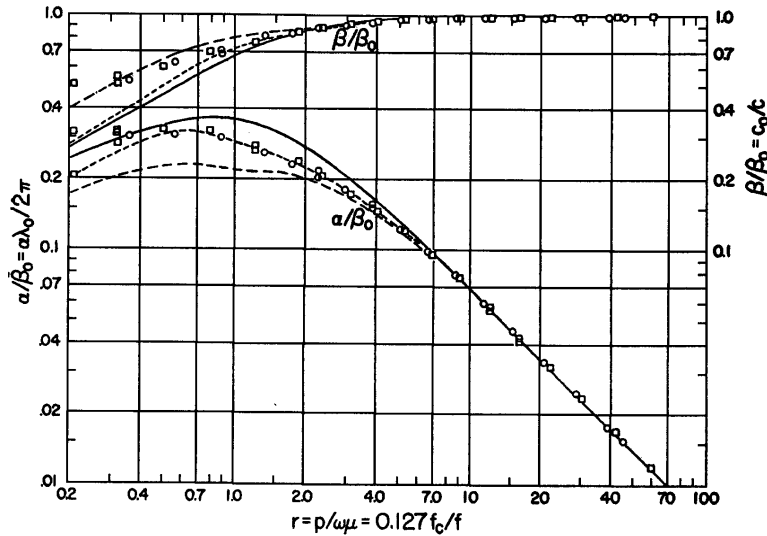

Fig. 2. Neon and argon at 11 MHz. Propagation constant as a function of r . Solid line: Stokes-Navier. Short dashed line: Burnett. Longer dashed line: Super Burnett. Circles: measurements in Ne. Squares: measurements in Ar.

α and β from measurements of neon and argon with three approximate theories: Stokes-Navier, Burnett, and Super Burnett. All five gases behave in substantially the same way. In the nondispersive range ($r >$ about 10) the measured values agree with the “classic” theory [3,6].

This work was extended to the measurement of viscosity effects for the diatomic gases nitrogen and oxygen and to dry air. Moe compared his theoretical predictions [5] to the attenuation and propagation constant of the diatomic gases as measured. The behavior at higher pressures follows the classic theory. As the mean free path approaches the ultrasonic wave length, Greenspan’s constructed theory fitted at the intermediate pressures. For lower pressures significant deviations were found [7]

His work on propagation of sound in rarefied gases is a classic example of how to examine a complex system for relaxations resulting in a measured dispersion. He was able to show that the Stokes-Navier equation gave a surprisingly good quantitative account of attenuation and dispersion of sound in monatomic gases down to wavelengths approaching the mean free path. Moreover, he succeeded in making measurements to much lower pressures where the mean free path was significantly greater than the wavelength, and found substantial deviations from the theories. New theoretical many-body results are now judged by their agreement with these data. For diatomic and polyatomic gases, where molecular relaxation processes associated with vibrational and rotational modes occur in addition to the translation relaxation, he was able to demonstrate

experimentally and theoretically how they combine to affect acoustic dispersion and attenuation.

In summary, Greenspan’s work made a major contribution to the fields of acoustics and thermodynamics by allowing the effects of nonuniformity in a rarefied gas to be separated from those of nonlinear behavior. He provided the first experimental data on elastic and viscous behavior of a number of rarefied monatomic and diatomic gases. His papers on this subject received more than 250 citations, and his chapter in the prestigious *Physical Acoustics* series is still widely read.

Martin (Moe) Greenspan was born in New York City on May 8, 1912. He attended Cooper Union Institute of Technology and received a B. S. degree in 1934. He came to the National Bureau of Standards in 1935 and was employed until his retirement in 1975. As a guest scientist, he continued to contribute to NIST actively until his death in 1987. He was a very productive, prolific, and innovative researcher, not only in the area described here, but in several other fields. From 1935 until 1945 he worked in engineering mechanics, performing theoretical calculations on complex structures such as rigid knee bends, box girders, and perforated plates. Such calculations were coordinated with experimental tests producing a higher assurance of confidence in the safety of these structures. Moe’s work on stress distribution in perforated plates, for which he received a Department of Commerce Silver Medal, was an important contribution to modern elastic fracture mechanics. During this period he authored at least 15 archival articles on theoretical engineering.

In August 1946, at the invitation of its Chief, Richard K. Cook, Moe joined the NBS Sound Section and began his work on physical acoustics, as described above. In the early 1950s he was approached by the Navy and asked to help develop a means of measuring speed of sound in the sea. Moe and Carl Tschiegg collaborated in the development of an accurate, reliable and rugged instrument now called an acoustic velocimeter. This device measured the sound speed in a continuous fashion in the deepest part of the sea. Since 1960, all Navy submarines have been equipped with a variation of this original device, which has also found extensive use in the chemical industry. This work also won the Department of Commerce Silver Medal. In the 1960s, Greenspan and Tschiegg investigated ultrasonic cavitation in water. They directed their attention to the effects of dissolved gases and neutron irradiation on the threshold of cavitation, finding that both dissolved gas and recoil atomic nuclei from neutron irradiation weaken the water and lower the cavitation threshold.

In 1966 Moe became chief of the Sound Section and in the 1970s turned his attention to problems in acoustic emission. Acoustic emission (AE) is transient in character. The usual calibration procedure is inadequate for AE transducer calibration. Moe was instrumental in proposing the use of special transfer blocks which could be excited by a step force function and which would follow a simple Lamb's solution. This was the basis of the acoustic emission calibration facility that was developed by Frank Breckenridge and Carl Tschiegg in collaboration with Moe. After his retirement, he examined the theoretical problem of an acoustic piston radiator. In a 1979 paper he succeeded in extending and improving the theory. Over his professional career (1935-1986) Moe authored more than 60 technical papers that were published in scholarly journals.

Despite the fact that Moe's formal education ended with his B. S. degree, he built a professional reputation of knowledge of acoustics matched by few others. His lecturing earned him an enviable international reputation. In addition to his professional duties for NBS, he lectured and taught courses in mathematics, engineering and physics at the University of Maryland,

Catholic University, George Washington University, NBS Graduate School, and the Department of Agriculture Graduate School. During the 1958-1959 academic year he was a visiting lecturer at the UCLA Physics Department. At the end of this duty he was offered a full professorship by UCLA, but he declined, preferring to return to his research duties at NBS.

Greenspan was a Fellow of the Acoustical Society of America and was elected President for 1966-1967. He chaired the Technical Council of the Society for 1967-1968 and was the Society's representative to the Council of the AAAS. He was an Associate editor (1961-1966) of the *Journal of the Acoustical Society of America and the Editor* (1962-1973) of the *Journal of Research of the National Bureau of Standards*, Section C. In addition to the two Silver Medals awarded by NBS, he received the Acoustical Society Silver Metal in Physical Acoustics (1977), their Gold Metal (1983), and the Harry Diamond Award of the IEEE (1980).

Prepared by Thomas M. Proctor.

Bibliography

- [1] M. Greenspan, Transmission of Sound Waves in Gases at Very Low Pressures, in *Physical Acoustics*, Vol. 2A, Academic Press, New York (1965) pp. 1-45.
- [2] M. Greenspan, Attenuation of sound in rarefied helium, *Phys. Rev.* **75**, 197-198 (1949).
- [3] M. Greenspan, Propagation of sound in rarefied helium, *J. Acoust. Soc. Am.* **22**, 568-571 (1950).
- [4] M. Greenspan and M. C. Thompson, Jr., An eleven megacycle interferometer for low pressure gases, *J. Acoust. Soc. Am.* **25**, 92-96 (1953).
- [5] M. Greenspan, Combined translational and relaxational dispersion of sound in gases, *J. Acoust. Soc. Am.* **26**, 70-73 (1954).
- [6] M. Greenspan, Propagation of sound in five monatomic gases, *J. Acoust. Soc. Am.* **28**, 644-648 (1956).
- [7] M. Greenspan, Rotational relaxation in nitrogen, oxygen, and air, *J. Acoust. Soc. Am.* **31**, 155-160 (1959).
- [8] M. Greenspan, Translational Dispersion in Gases, in *Dispersion and Absorption of Sound by Molecular Processes*, Estratto da Rendiconti della Scuola Internazionale di Fisica Enrico Fermi, XXVII Corso, Academic Press, New York (1963) pp. 73-100.
- [9] Isadore Rudnick, Citation to Martin Greenspan, *J. Acoust. Soc. Am.* **73**, S33 (1983).

Atomic Energy Levels and Other Spectroscopic Data

The key advances in our understanding of atomic structure were made early in the 20th Century. Niels Bohr developed his revolutionary theory of the hydrogen atom in 1913, still largely on classical terms. Then, in the 1920s, the generalization to other atoms and ions came with the development of quantum mechanics, or wave mechanics, by Schroedinger, Heisenberg and others, after de Broglie postulated that all elementary particles also have wave properties. Important later generalizations and refinements were the relativistic extensions by Dirac, as well as quantum electrodynamics by Feynman, Schwinger, and others. Even before these developments took place, many highly precise spectroscopic data had been obtained experimentally, and these data could now be fully understood in terms of atomic structure and quantum numbers. Thus, laboratory and astrophysical spectra could for the first time be interpreted as specific classified transitions between energy levels of atoms or positive ions.

The three volumes of tables in the *Atomic Energy Levels* series cited here [1-3] represented a synthesis of the data derived from studies of atomic spectra in the first half of the century—studies which played a major role in the revolution in physics just described. The effort can be traced to an initiative of the National Research Council, which in 1924 created a Committee on Line Spectra of the Elements, with one of its main goals being to encourage work on the analysis of atomic spectra and to collect atomic structure data in a systematic manner. A first, still rather incomplete, tabulation was undertaken by Bacher and Goudsmit in 1932 with a book entitled *Atomic Energy States as Derived from the Analysis of Optical Spectra* [4]. In the following years, spectroscopic data were accumulated on a vast scale, especially for somewhat heavier atoms and ions, and in the middle 1940s, with the strong support of the Line Spectra Committee, NBS Director E. U. Condon agreed to undertake a new data compilation project at NBS, after Bacher and Goudsmit declined to update their book. Charlotte E. Moore, already an expert in the compilation of atomic spectra and author of the Princeton Observatory *Multiplet Tables of Astrophysical Interest* of 1933 and 1945 [5], accepted a position at NBS in 1945 to prepare a handbook of atomic energy levels. This project achieved a first milestone in 1949 with the publication of Volume I of *Atomic Energy Levels*, containing the spectra of hydrogen, (atomic number $Z=1$) through vanadium ($Z=23$), 309 pages

strong [1]. In 1952, Volume II with the elements chromium ($Z=24$) through niobium ($Z=42$) followed [2], and in 1958 a third volume containing the spectra of molybdenum ($Z=42$) through actinium ($Z=89$) completed this series [3], also known as NBS Circular 467.

In all these tables, the principal data presented are the atomic energy levels (or “energy eigenstates”) compiled from experimentally determined (published or unpublished) material. This was done for those stages of ionization for which reliable data existed. All data were critically compiled, which means that in cases where several experimental results were available, only the best value was selected after critical evaluation. In addition to the level values, the spectroscopic configuration and term assignment, the total angular momentum quantum number, and the ionization energy of the atom or ion were presented, and all this material was arranged in a highly organized, easily readable format.

The NBS/NIST critical tables on atomic energy levels, wavelengths, and transition probabilities are the preeminent resource for atomic spectroscopy data.

As laboratory and astrophysical studies of atomic spectra and their application for plasma diagnostics and modeling became increasingly sophisticated, another principal spectroscopic quantity characterizing the strength of spectral lines assumed critical importance. This atomic constant is known as the atomic transition probability, or oscillator strength, or line strength. But atomic transition probabilities are much more difficult to determine precisely, both experimentally and theoretically. In the 1930s to 1950s, they were determined only on a small scale, and the uncertainties were—except for hydrogen—often quite large. But the situation gradually improved, and upon the urging of several scientific communities, NBS started to compile critically atomic transition probability data. Two volumes of *Atomic Transition Probabilities* covering the first twenty elements, i.e., hydrogen ($Z=1$) through neon ($Z=10$) and sodium ($Z=11$) through calcium ($Z=20$) were published in 1966 and 1969 by W. L. Wiese and coworkers [6,7]. These books were structured in a manner similar to the energy level volumes and contained both the transition

probabilities and the equivalent expressions of oscillator strength and line strength, since different user communities work with different quantities. Both experimental and theoretical sources of data were utilized. In contrast to the highly precise energy level and wavelength data, the uncertainties of many transition probabilities were still appreciable, larger by orders of magnitude than those for wavelength and energy level data. Also, the body of available data was much smaller. Uncertainties can be directly determined for the experimental data, but this is nearly impossible for calculated results. For many prominent transitions, the available data were redundant, but often disagreed with each other. Therefore, a system for judging the quality of transition probability data became essential, and discussions of the data selections were presented for each spectrum. To this day, a coding system for the uncertainties is applied, with letters A to D, where A-class data are estimated accurate within $\pm 3\%$ and the lowest admissible class of reference data is D, with uncertainties estimated not to exceed $\pm 50\%$. Detailed numerical uncertainty estimates are still not realistic in many cases.

In toto, C. E. Moore's atomic energy level books covered 75 chemical elements and 485 spectra in different ionization states. They became an essential tool for atomic, plasma, and astro-physicists as well as spectrochemists. About 7000 copies of each book were sold, and the books were reprinted in 1971 as NSRDS-NBS 35. The books were featured by "Current Contents" as a citation classic in 1990 [8] after they were cited in more than 7900 publications. This number has since then steadily increased to about 13 000 citations.

Similarly, the tables of atomic transition probabilities became widely used and cited. A total of about 7000 copies were sold. They were featured as citation classics [9] in 1989 and have been cited about 4000 times. Almost from the beginning, the spectroscopic data compilation program drew support from the user communities because of the need for comprehensive data sources that were critically evaluated. NASA and the Department of Energy have been long-term supporters of the data program and are continuing to support it to this date. User communities also voiced their strong support and published resolutions and expressions of need for the NBS/NIST data compilations. Examples include several resolutions by the General Assemblies of the International Astronomical Union (IAU), the latest in 1976, that "the IAU highly values the activities of NBS in the critical compilation of atomic and molecular data, and considers these activities essential for the advancement of astronomy" [10]. The spectrochemical community devoted a special issue of their journal *Spectrochimica Acta* to their atomic data needs [11].

Numerous personal letters of support and gratitude of leading physicists and astrophysicists have been received over the years, among them letters from the Nobelists Niels Bohr, Linus Pauling, Isidor Rabi, Gerhard Herzberg, Alfred Kastler, and Arthur Schawlow. Schawlow noted in one of his letters that the NBS spectroscopic data tables were essential tools in the search for new laser materials and laser wavelengths.

The NBS/NIST data program has been, and continues to be, involved in worldwide collaborations and services. For example, NBS scientists have served as presidents of the IAU Commission on Atomic and Molecular Data and as chairs of IAU working groups; NBS/NIST is the principal supplier of spectroscopy data to a worldwide network of data centers under the auspices of the International Atomic Energy Agency, Vienna; NBS writes a regular column "News on fundamental reference data" for the journal *Spectrochimica Acta B*; and the group collaborates with British, French, German, Japanese, Russian, and Swedish groups as well as several institutions in the United States on especially pressing data needs. Outside groups have often turned to NIST to find out where problems and discrepancies in the data occur and where they can assist. Parallel to the data compilation program, NIST has always maintained a cutting-edge research program in spectroscopy, since only hands-on participation with state-of-the-art experimental and theoretical techniques gives NIST the authority for making thorough, realistic judgments in the critical evaluations.

Charlotte E. Moore did her Ph.D. at the University of California, Berkeley, on the spectra of sunspots, then worked at Princeton University Observatory and produced there her first comprehensive spectroscopic compilation, *A Multiplet Table of Astrophysical Interest* [5], a first edition in 1933 and a revised and greatly enlarged one in 1945. Shortly afterwards she came to NBS, where she was a member of the Atomic Spectroscopy Section until her retirement in 1968. She was married to Bancroft Sitterly, an astronomer and mathematician at American University, and was known throughout NBS as "Mrs. Sitterly." After retirement, she continued her critical compilation work at NBS into her mid-eighties and also worked for several years at the Naval Research Laboratory on the ultraviolet spectrum of the sun. During all her work, she interacted closely with spectroscopists all over the world, not only obtaining valuable additional unpublished material but also persuading the specialists to carry out more measurements and analyses that she badly needed for the tabulations. She thus exerted considerable influence on the field of spectroscopy for many years. She died in 1990 at the age of 91.



Fig. 1. Charlotte Moore-Sitterly, seated on the far right, receives the Federal Woman's Award in the White House from Lyndon B. Johnson, seated on the far left.

Charlotte Moore received numerous awards and honors, among them honorary Ph.D.s from Swarthmore College, the University of Michigan, and the University of Kiel, Germany; the Department of Commerce Gold and Silver medals; and the William F. Meggers Award of the Optical Society of America. In 1961, she was one of six women who received the first Federal Woman's Award.

W. L. Wiese received his Ph.D. in 1957 at the University of Kiel, Germany, and after working for two years at the University of Maryland, joined NBS in 1960. He started a group on plasma spectroscopy as well as the data center on atomic transition probabilities in 1962 and has led the Atomic Physics Division (formerly the Atomic and Plasma Radiation Division) since 1977. He was a Guggenheim fellow, received the A.V. Humboldt Award, the Department of Commerce Gold and Silver Medals, an honorary Ph.D. from the University of Kiel,

the Distinguished Career in Science Award of the Washington Academy of Sciences, and other honors.

In recent years, William C. Martin—the leader of the Atomic Spectroscopy Group from 1962 to 1998—and his colleagues Charles Corliss, Arlene Musgrove, Joseph Reader, Jack Sugar, and Romuald Zalubas maintained the high quality of the NBS work on the atomic energy level and wavelength tables and expanded and updated much of Charlotte Moore's work. Some of their major works are cited in the selected bibliography [12-16]. W. L. Wiese and his colleagues Teresa Deters, Jeffrey Fuhr, and Georgia Martin continued the transition probability tabulations for heavier elements and also updated the tables for some light elements [17-19].

In the past few years, the NIST atomic spectroscopists combined their efforts and utilized the Internet as the new dissemination medium to establish a unified comprehensive *Atomic Spectra Database* on the World Wide

Web [20] which contains spectral reference data for 91 000 wavelengths, 45 000 transition probabilities and 70 000 energy levels, covering all natural elements (and some man-made ones up to $Z=100$) and—with many stages of ionization included—a total of 450 spectra. This database, with the latest version published in March 1999, has quickly become very popular, with about 45 000 hits per month and rising.

Prepared by Wolfgang L. Wiese.

Bibliography

- [1] Charlotte E. Moore, *Atomic Energy Levels, Vol. I (Hydrogen through Vanadium)*, Circular of the National Bureau of Standards 467, U.S. Government Printing Office, Washington, DC (1949).
- [2] Charlotte E. Moore, *Atomic Energy Levels, Vol. II (Chromium through Niobium)*, Circular of the National Bureau of Standards 467, U.S. Government Printing Office, Washington, DC (1952).
- [3] Charlotte E. Moore, *Atomic Energy Levels, Vol. III (Molybdenum through Lanthanum and Hafnium through Actinium)*, Circular of the National Bureau of Standards 467, U.S. Government Printing Office, Washington, DC (1958).
- [4] Robert F. Bacher and Samuel Goudsmit, *Atomic Energy States*, McGraw-Hill, New York (1932).
- [5] Charlotte E. Moore, *A Multiplet Table of Astrophysical Interest*, Princeton University Observatory, Princeton, NJ (1933); revised in 1945.
- [6] W. L. Wiese, M. W. Smith, and B. M. Glennon, *Atomic Transition Probabilities, Vol. I Hydrogen through Neon*, Natl. Stand. Ref. Data Ser., Natl. Bur. Stand. (U.S.) 4, U.S. Government Printing Office, Washington, DC (1966).
- [7] W. L. Wiese, M. W. Smith, and B. M. Miles, *Atomic Transition Probabilities, Vol. II Sodium through Calcium*, Natl. Stand. Ref. Data Ser., Natl. Bur. Stand. (U.S.) 22, U.S. Government Printing Office, Washington, DC (1969).
- [8] W. L. Wiese and W. C. Martin, Reference Data of Atomic Spectroscopy—a Citation Classic Commentary on Atomic-Energy Levels as Derived from the Analyses of Optical-Spectra, Vol. 1-3 by Moore, C. E., *Curr. Contents Phys. Chem. Earth Sci.* **47**, 12 (1990); also in *Curr. Contents Eng. Tech. Appl. Sci.* **47**, 12 (1990).
- [9] W. L. Wiese, A Critical Table of Atomic Transition-Probabilities—A Citation Classic Commentary on Atomic Transition-Probabilities, Vol. 1, Hydrogen Through Neon by Wiese, W. L., Smith, M. W., and Glennon, B. M., *Curr. Contents Phys. Chem. Earth Sci.* **40**, 16 (1989); also in *Curr. Contents Eng. Tech. Appl. Sci.* **40**, 16 (1989).
- [10] *Trans. Int. Astron. Union XVI B*, **33**, D. Reidel Publish. Co., Dordrecht, Netherlands (1977).
- [11] Special issue of *Spectrochimica Acta*, Vol. 43B, No. 1 (1988).
- [12] W. C. Martin, Romuald Zalubas, and Lucy Hagan, *Atomic Energy Levels—The Rare-Earth Elements*, Natl. Stand. Ref. Data Ser., Natl. Bur. Stand. (U.S.) 60, U.S. Government Printing Office, Washington, DC (1978).
- [13] Joseph Reader, Charles H. Corliss, W. L. Wiese, and G. A. Martin, *Wavelengths and Transition Probabilities for Atoms and Atomic Ions, Part I. Wavelengths, Part II. Transition Probabilities*, Natl. Stand. Ref. Data Ser., Natl. Bur. Stand. (U.S.) 68, U.S. Government Printing Office, Washington, DC (1980).
- [14] Jack Sugar and Charles Corliss, Atomic Energy Levels of the Iron-Period Elements: Potassium through Nickel, *J. Phys. Chem. Ref. Data* Vol. 14, Supplement No. 2 (1985).
- [15] Charlotte E. Moore, *Tables of Spectra of Hydrogen, Carbon, Nitrogen, and Oxygen Atoms and Ions*, Jean W. Gallagher (ed.), CRC Press, Boca Raton, FL (1993).
- [16] T. Shirai, J. Sugar, A. Musgrove, and W. L. Wiese, Spectral Data for Highly Ionized Atoms: Ti, V, Cr, Mn, Fe, CO, Ni, Cu, Kr, and Mo, *J. Phys. Chem. Ref. Data*, Monograph 8 (2000).
- [17] G. A. Martin, J. R. Fuhr, and W. L. Wiese, Atomic Transition Probabilities—Scandium through Manganese, *J. Phys. Chem. Ref. Data* Vol. 17, Suppl. 3 (1988).
- [18] J. R. Fuhr, G. A. Martin, and W. L. Wiese, Atomic Transition Probabilities—Iron through Nickel, *J. Phys. Chem. Ref. Data* Vol. 17, Suppl. 4 (1988).
- [19] W. L. Wiese, J. R. Fuhr, and T. M. Deters, Atomic Transition Probabilities of Carbon, Nitrogen and Oxygen—A Critical Data Compilation, *J. Phys. Chem. Ref. Data*, Monograph 7 (1996).
- [20] Atomic Spectra Database, (<http://physics.nist.gov/PhysRefData/ASD1/>) National Institute of Standards and Technology. .

Iteration Method for the Solution of the Eigenvalue Problem of Linear Differential and Integral Operators

In 1946, the Office of Naval Research asked NBS to help found a national center for mathematical computation. This center was to have four parts, the first of which was the Institute for Numerical Analysis (INA). The NBS director, E. U. Condon, sent his assistant, John Curtiss, to the west coast, and it was decided to locate the institute on the campus of UCLA. The INA was successful in attracting several renowned scientists, including Cornelius Lanczos, who was then working at the Boeing Aircraft Company in Seattle. Lanczos, a physicist and applied mathematician, had already been very successful at devising algorithms for analyzing a variety of mathematical models, and he was well acquainted with the challenges of computation on desk calculators. Since part of the INA mission was to promote the effective use of the new “high-speed” automatic digital computers, his expertise was quite relevant, and he was immediately successful in solving problems of interest to the researchers there.

Lanczos first turned his attention to the solution of linear systems of equations and matrix eigenvalue problems. The eigenvalue problem was of particular interest to him, as he notes at the beginning of his paper [1], since the “vibrations of elastic structures, the flutter problems of aerodynamics, the stability problem of electric networks, [and] the atomic and molecular vibrations of particle physics” [1, p. 255] can all be analyzed in this way.

Computational researchers of that era faced a variety of challenges. With only minimal understanding of the effects of round-off errors on computations, they also needed to deal with remarkably small computer memories and limited computational capabilities. The SWAC, for instance, the NBS Western Automatic Computer, came on line in July 1950, capable of 16,000 operations per second on its 256 words of memory [2, Appendix C]!

It was in this computational environment that Lanczos investigated his method of “minimized iterations,” a continuation of some work begun at Boeing.

Lanczos’ presentation in this paper is almost matrix-free, not at all like the exposition of his algorithm in contemporary textbooks [3, Chap. 9]. Yet the description is spare and elegant. He begins by noting that linear differential and integral operator equations can be solved



Fig. 1. Cornelius Lanczos in 1946 (Courtesy of Mrs. Eleanor Boyk; used with permission from North Carolina State University [12]).

by considering either of two series: the “Liouville-Neumann expansion,” which only requires application of the operator but can suffer convergence difficulties; or the “Schmidt series,” which is unconditionally convergent but requires knowledge of the eigensystem (Section II). Lanczos makes the remarkable observation that the first idea (which now is more commonly called a Krylov subspace expansion) can be improved by choosing a different set of basis functions, and he proposes a basis that is computationally convenient and numerically better behaved. Even better, his basis gives a finite expansion, rather than a series expansion, and thus yields a terminating algorithm, better suited for automatic computers. He devotes considerable attention to a numerical example that illustrates the algorithm and

presents a model for the bookkeeping involved in its use (Section VI). But part of the genius of the paper is that he doesn't stop there, but turns his attention to the very real numerical difficulties that can develop if the algorithm is used on large matrices, which to him mean those of dimension 12 or higher (Section VII). These difficulties motivated a major improvement of the algorithm: the development of a way to compute a basis using a three-term recurrence. With this improvement, he demonstrates the algorithm's effectiveness on practical problems, such as computing the lateral vibrations of a bar (Section IX) and vibrations of a membrane and a string (Section X), through computational experiments carried out by Fannie M. Gordon. In the last sections of the paper, he discusses how to overcome complications that arise when finding the eigensystem of an operator rather than a matrix.

This work fit in very nicely with other developments at INA. Researchers such as George Forsythe, J. Barkley Rosser, and Magnus Hestenes were also thinking about eigenvalue problems and the solution of linear systems, and during the next two or three years they proposed and tested a variety of approaches for "large" problems. Lanczos, too, discussed the solution of linear systems using the recurrence of his minimized iterations [4], and recognized that it was mathematically equivalent to the method of conjugate gradients [5], another noteworthy NBS discovery discussed elsewhere in this volume.

Despite the original promise of the method of minimized iterations, very little attention was given to it during the following 10 years. Other algorithms were more successful on problems of moderate size, and when "large" came to mean of dimension 1000 or larger, even the three-term recurrence had significant numerical difficulties. But two research projects renewed interest in the algorithm. In 1966, Shmuel Kaniel [6] studied the accuracy of the eigenvalue and eigenvector estimates when Lanczos' iteration is terminated early, as it must be when the size of the matrix is prohibitively large. This opened the possibility of using the algorithm to *approximate* the eigensystem, rather than aim for full accuracy. In 1971, Chris Paige [7,8,9] showed that even though round-off error ruins the orthogonality of Lanczos' basis, the necessary level of accuracy can be maintained by judicious choice of parameters and selective use of reorthogonalization. Paige's form of Lanczos' algorithm was now a practical alternative for truly large matrices.

Since then, continuous attention has been given to the method. Almost 300 articles were published about Lanczos' algorithm and related Krylov methods in the 25 years following publication of Lanczos' paper [10], and copious citations to it continue to this day even though it is a standard topic in textbooks and many

citations do not go back to this primary source. There are several widely used numerical software packages, including one due to Horst Simon and coworkers such as Beresford Parlett at the University of California, Berkeley, and another due to Jane Cullum and Ralph Willoughby, developed at IBM. A package by David Scott is available through NIST's Guide to Available Software (GAMS) project.

This Krylov subspace method of Lanczos, and its later application to the solution of linear systems, was recently designated one of the Top Ten Algorithms of the Century [11] by *Computing in Science and Engineering*, a joint publication of the IEEE Computer Society and the American Institute of Physics.

A fascinating account of Lanczos' life is given in an essay by Barbara Gellai at the beginning of the six volumes of his collected works [12, Vol 1, (1-3)-(1-31)]. Cornelius Lanczos (born Kornél Löwy) began and ended his life peacefully in Hungary, but his life pivoted on three exiles. He was born in 1893, the eldest son of a Jewish lawyer. He attended Jewish elementary school, Catholic secondary school, and the University of Budapest. His Ph.D. work concerning special relativity received some attention by Einstein, but political turmoil in Hungary and a ceiling for the number of Jews at universities led Lanczos to move to Germany. He continued his work in physics, and published an integral formulation of the Schrödinger equation [13] just before Schrödinger published his differential equation formulation, but Lanczos' paper was misinterpreted for many years. During this period, he spent a year as Einstein's assistant, continued his work, and married a German, Maria Rupp.

In 1931, Lanczos began a second exile, as economic and political troubles made life in Germany difficult. Lanczos took a visiting position at Purdue University, but unfortunately had to travel without his wife, who had contracted tuberculosis and could not get a visa. He continued his work on Einstein's field equations, Dirac's equation, and other topics in physics, but increasingly his attention focused on mathematical techniques, and he developed the Tau method for approximating functions by telescoping series [14]. His wife died in 1939, and he brought his son to the United States. During this period he also became known as an excellent teacher, eventually writing many popular and groundbreaking textbooks, celebrated for their clarity and their use of vivid examples. His approach to computation was unique for the time: he worked with calculator, not slide rule, and this led him to novel algorithmic approaches. In the early 1940s he derived a method for evaluating Fourier coefficients quickly [15], although the idea did not become widely known until the popularization of the (equivalent) Cooley-Tukey FFT algorithm.

During 1943-44, Lanczos had his first association with NBS, working on the Mathematical Tables Project, during a leave from Purdue. After some time at Boeing Aircraft Company in Seattle, he joined the Institute for Numerical Analysis of the NBS. This provided a fertile working environment, and Lanczos investigated algorithms for solving linear systems of equations and eigenvalue problems. But eventually, politicized investigations led to the resignation of Edward Condon as Director of NBS. Lanczos, too, came under investigation for allegedly being a communist sympathizer, and this may have contributed to his decision to begin a third exile, in 1952, and then permanently in 1954, to the Dublin Institute for Advanced Studies.

For the rest of his life, Lanczos maintained his ties to Dublin, although he traveled and lectured extensively. His expository skills were much renowned, and he won the Chauvenet Prize for mathematical exposition in 1960 for one of his papers [16]. He married another German, Ilse Hildebrand, and resumed his concentration on physics research, including the geometry of space-time, although his publications in mathematics continued. He died of a heart attack on his second visit back to Hungary, in 1974.

Interest in Lanczos' work continues, however. A centenary celebration was held at North Carolina State University, and his eigenvalue paper [1] in particular continues to be a cornerstone of contemporary eigenvalue computation and research, with over 850 citations in *Science Citation Index* between 1983 and 1999.

Prepared by Dianne P. O'Leary.

Bibliography

- [1] Cornelius Lanczos, An Iteration Method for the Solution of the Eigenvalue Problem of Linear Differential and Integral Operators, *J. Res. Natl. Bur. Stand.* **45**, 255-282 (1950).
- [2] Magnus R. Hestenes and John Todd, *NBS-INA—The Institute for Numerical Analysis—UCLA 1947-1954*, NIST Special Publication 730, National Institute of Standards and Technology, Gaithersburg, MD (1991).
- [3] Gene H. Golub and Charles F. Van Loan, *Matrix Computations, Third Edition*, Johns Hopkins University Press, Baltimore, MD (1996).
- [4] Magnus R. Hestenes and Eduard Stiefel, Methods of Conjugate Gradients for Solving Linear Systems, *J. Res. Natl. Bur. Stand.* **49**, 409-436 (1952).



Fig. 2. Olga Taussky Todd and Cornelius Lanczos. Taussky Todd (1906-1995) was one of the original members of the NBS Institute for Numerical Analysis (1947-48) and was subsequently a consultant to the NBS Applied Mathematics Division in Washington (1949-54). She was an insightful and prolific mathematician who made many important contributions to early numerical analysis, especially in the areas of linear algebra and matrix theory.

- [5] Cornelius Lanczos, Solution of Systems of Linear Equations by Minimized Iterations, *J. Res. Natl. Bur. Stand.* **49**, 33-53 (1952).
- [6] Shmuel Kaniel, Estimates for Some Computational Techniques in Linear Algebra, *Math. Comp.* **20**, 369-378 (1966).
- [7] C. C. Paige, *The Computation of Eigenvalues and Eigenvectors of Very Large Sparse Matrices*, Ph.D. Dissertation, University of London (1971).
- [8] C. C. Paige, Practical Use of the Symmetric Lanczos Process with Re-Orthogonalization, *BIT* **10**, 183-195 (1970).
- [9] C. C. Paige, Computational Variants of the Lanczos Method for the Eigenproblem, *J. Inst. Math. Appl.* **10**, 373-381 (1972).
- [10] Gene H. Golub and Dianne P. O'Leary, Some History of the Conjugate Gradient and Lanczos Algorithms: 1948-1976, *SIAM Rev.* **31**, 50-102 (1989).
- [11] Top 10 Algorithms of the Century, *Comput. Sci. Eng.* **2** (1), (2000).
- [12] William R. Davis, ed., *Cornelius Lanczos, Collected Published Papers with Commentaries*, College of Physical and Mathematical Sciences, North Carolina State University, Raleigh, NC (1998).
- [13] Kornel Lanczos, Über eine feldmäßige Darstellung der neuen Quantenmechanik, *Z. Phys.* **35**, 812-830 (1926).
- [14] C. Lanczos, Trigonometric Interpolation of Empirical and Analytical Functions, *J. Math. Phys.* **17**, 123-199 (1938).
- [15] G. C. Danielson and C. Lanczos, Some Improvements in Practical Fourier Analysis and Their Application to X-Ray Scattering from Liquids, *J. Franklin Inst.* **233**, 365-380, 435-452 (1942).
- [16] C. Lanczos, Linear Systems in Self-Adjoint Form, *Amer. Math. Monthly* **65**, 665-679 (1958).

Methods of Conjugate Gradients for Solving Linear Systems

The advent of electronic computers in the middle of the 20th century stimulated a flurry of activity in developing numerical algorithms that could be applied to computational problems much more difficult than those solved in the past. The work described in this paper [1] was done at the Institute for Numerical Analysis, a part of NBS on the campus of UCLA [2]. This institute was an incredibly fertile environment for the development of algorithms that might exploit the potential of these new automatic computing engines, especially algorithms for the solution of linear systems and matrix eigenvalue problems. Some of these algorithms are classified today under the term *Krylov Subspace Iteration*, and this paper describes the first of these methods to solve linear systems.

Magnus Hestenes was a faculty member at UCLA who became associated with this Institute, and Eduard Stiefel was a visitor from the Eidgenössischen Technischen Hochschule (ETH) in Zürich, Switzerland. At this time, there were two commonly used types of algorithms for solving linear systems. The first, like Gauss elimination, modified a tableau of matrix entries in a

systematic way in order to compute the solution. These methods were finite, but required a rather large amount of computational effort with work growing as the cube of the number of unknowns. The second type of algorithm used “relaxation techniques” to develop a sequence of iterates converging to the solution. Although convergence was often slow, these algorithms could be terminated, often with a reasonably accurate solution estimate, whenever the human “computers” ran out of time.

The ideal algorithm would be one that had finite termination but, if stopped early, would give a useful approximate solution. Hestenes and Stiefel succeeded in developing an algorithm with exactly these characteristics, the method of conjugate gradients.

The algorithm itself is beautiful, with deep connections to optimization theory, the Pad table, and quadratic forms. It is also a computational gem, the standard algorithm used today to solve large sparse systems of equations, involving symmetric (or Hermitian) positive definite matrices, for which matrix modification methods are impractical.



Fig. 1. Wolfgang Wasow (left) and Magnus Hestenes (right).



Fig. 2. Eduard Stiefel [From *Zeitschrift für angewandte Mathematik und Physik* **30**, 139 (1979); used with permission].

The INA group was quite collegial, and many of the ideas in this paper have roots in joint discussions among many participants. Hestenes and Stiefel summarize the development this way [1, pp. 409-410]:

“The method of conjugate gradients was developed independently by E. Stiefel of the Institute of Applied Mathematics at Zurich and by M. R. Hestenes with the cooperation of J. B. Rosser, G. Forsythe, and L. Paige of the Institute for Numerical Analysis, National Bureau of Standards. The present account was prepared jointly by M. R. Hestenes and E. Stiefel during the latter’s stay at the National Bureau of Standards. The first papers on this method were given by E. Stiefel [1952] and by M. R. Hestenes [1951]. Reports on this method were given by E. Stiefel and J. B. Rosser at a Symposium on August 23-25, 1951. Recently, C. Lanczos [1952] developed a closely related routine based on his earlier paper on eigenvalue problem [1950]. Examples and numerical tests of the method have been by R. Hayes, U. Hoshstrasser, and M. Stein.”

The papers referred to in this summary are those of Stiefel [3], Hestenes [4], and Lanczos [5,6], the last of which is discussed elsewhere in this volume.

It is interesting to hear two distinct voices in this paper of Hestenes and Stiefel. Hestenes came to the

algorithm from the point of view of variational theory and optimal control. In 1936 he had developed an algorithm for constructing a set of mutually conjugate basis vectors, but was advised by a Harvard professor that it was too obvious for publication [7]. Yet this background, plus discouraging numerical experience by George Forsythe in using the steepest descent algorithm for solving linear systems, was grist for the mill in the development of the conjugate gradient algorithm. Stiefel, on the other hand, had a strong orientation toward relaxation algorithms, continued fractions, and the qd-algorithm, and he developed conjugate gradients from this viewpoint.

The technical contributions of the paper begin in Section 3, with a rather terse algebraic presentation of the formulas of the conjugate gradient algorithm. Motivation comes later, with the observation that the recurrences lead to a sequence of approximations that converge monotonically in the sense of reducing an error function. At the same time, a sequence of polynomials can be constructed in order to find the eigen-system of the matrix. In the next section, the authors explain that the algorithm is a special case of a conjugate direction algorithm, and it is this property that yields finite termination. Algebraic properties are further developed in Section 5, which presents some alternate computational formulas. Sections 6 and 7 are more geometric, discussing optimization properties of the solution estimates. Section 8 turns to practical considerations: will round-off errors on electronic computers render this theoretically beautiful algorithm useless? The rather conservative analysis led to the conclusion that although round-off certainly hurts the algorithm, reasonable precautions and end corrections could overcome this in most cases. Section 9 explored different normalization options. In Section 10, “extensions” were proposed; in particular, the authors discussed how to solve nonsymmetric problems by considering the normal equations, and how to choose a preconditioning matrix in order to make the method applicable to broader classes of matrices. Section 11 discusses the construction of conjugate bases, and in Sections 12 and 13, the authors note that there is a close relation between conjugate gradients and Gauss elimination. Other relations are explored in later sections: continued fractions and the theory of orthogonal polynomials (Sections 14, 15, 17, and 18), and eigenvalue computations (Section 16).

The paper concludes with some numerical examples demonstrating the usefulness of the algorithm on a matrix of dimension 4 using exact arithmetic, a well-conditioned matrix of dimension 6 with some rounding error, and an ill-conditioned matrix of dimension 3, in which the conjugate gradient solution was about as



Fig. 3. Researchers associated with the NBS Institute for Numerical Analysis (1950). From left to right: Mark Kac, Edward J. McShane, J. Barkley Rosser, Aryeh Dvoretzky, George E. Forsythe, Olga Taussky-Todd, Wolfgang R. Wasow, and Magnus R. Hestenes.

accurate as that from Gauss elimination. The authors remind us how difficult numerical computations were in the middle of the 20th century: the algorithm had been used to solve 106 difference equations on the Zuse computer at ETH (with a sufficiently accurate answer obtained in 90 iterations); to solve systems as large as dimension 12 on an IBM “card programmed calculator”; and to solve small systems on the SWAC (Standards Western Automatic Computer), which had only 256 words of memory [2, Appendix C].

Hestenes and Stiefel’s paper remains the classic reference on this algorithm, explaining the use of the algorithm as both a finitely terminating method and as a way of obtaining an approximate solution if halted before termination. It is such a rich paper that it contains the roots of virtually all of the advances in this area up to the present time: for example, preconditioning to accelerate convergence of the algorithm, variations that can be used to solve systems of equations involving nonsymmetric matrices, and evaluation of computational variants in order to choose the most numerically stable one.

The algorithm garnered considerable early attention but went into eclipse in the 1960s as naive implementations were unsuccessful on some of the ever-larger problems that were being attempted. Work by John Reid [8] in the early 1970s drew renewed attention to the algorithm, and since then it has been an intense topic of research. Today it is the standard algorithm for solving linear systems involving large, sparse, symmetric (or Hermitian) matrices. Strategies for constructing preconditioning matrices, which reduce the number of iterations, remain a major research theme, as well as understanding the convergence properties of some non-symmetric variants. Some of the early history of the algorithm is discussed in [9].

Despite the fact that the algorithm has become a standard topic in numerical textbooks, the original paper is still widely read and cited; *Science Citation Index* lists over 800 citations between 1983 and 1999, and it is clear that this algorithm, and the non-symmetric variants developed to complement it, will remain the standard algorithms for solving sparse linear systems for the foreseeable future.

The conjugate gradient algorithm was but one claim to greatness for these remarkable and multifaceted researchers.

Magnus R. Hestenes [10] was born in Brice lyn, Minnesota, in 1906. His undergraduate work was at St. Olaf College, and his graduate work at the University of Wisconsin and the University of Chicago. His first faculty appointment was at Chicago, but he left in 1947 to accept a professorship at UCLA, where he taught until his retirement. He had 34 Ph.D. students and was a well-loved advisor and teacher, known for his nurturing kindness toward his very junior colleagues. Administrative duties over the years included chairing the Mathematics Department, directing the university's computing center, and serving as vice president of the American Mathematical Society. He also held appointments with the Rand Corporation, the Institute for Defense Analyses, and the IBM Watson Research Center. His association with NBS's INA lasted from 1949 to 1954, when the INA was transferred from NBS to UCLA. His best known works include many publications on the problem of Bolza, a famous paper on quadratic forms in Hilbert space [11], and the conjugate gradient paper with Stiefel. Hestenes remained scientifically active until his death in 1991, concentrating in his later years on the method of multipliers and continuing to write and publish.

Eduard Stiefel [12] was born in Zürich, Switzerland. He spent virtually his entire career at the Eidgenössischen Technischen Hochschule (ETH) in Zürich, first as a student of mathematics and physics, and then, following his habilitation degree in 1943, as a professor. His early work was in topology, eventually studying the geometry and topology of Lie groups. 1948 was a turning point for him, however. He founded the Institut für Angewandte Mathematik (Institute for Applied Mathematics) at ETH, in collaboration with Heinz Rutishauser and Ambros P. Speiser. Stiefel was a visionary who realized the enormous significance of the new computing technology and the impact it would have on mathematics and science. When he discovered in 1949 that a major computing engine, the Z4 of the German designer Konrad Zuse, was sitting in the small alpine village of Neukirchen, Germany, he traveled there and arranged for the machine to be rented and moved to ETH. Zuse, isolated by wartime secrecy, had independently developed computing technology that in many ways was superior to that available in the U.S. at the time [13]. Stiefel's initiative made ETH the first European university with an electronic computer, putting it in the forefront of numerical computation and computer

science. This led to several breakthrough developments by him and his colleagues, including the qd algorithm, the programming language ALGOL, and the conjugate gradient algorithm. His own interests evolved toward numerical algorithms, and he made substantial contributions in computational linear algebra, quadrature, and approximation theory before turning his attention to mechanics and celestial mechanics late in his life [14]. His technical works include over 60 journal publications and a wonderful 1960s textbook on numerical mathematics. He died in 1978, a few months short of his 70th birthday.

Computing in Science and Engineering, a publication of the IEEE Computer Society and the American Institute of Physics, named Krylov Subspace Iteration as one of the Top 10 Algorithms of the Century [15], citing in particular the pioneering work of Hestenes, Stiefel, and Lanczos. The citation reads:

*Krylov Subspace Iteration
Hestenes, Stiefel, Lanczos
Conjugate gradient methods are iterative matrix algorithms for solving very large linear systems of equations, especially efficient for sparse square matrices. Such systems arise in various application areas, such as modeling of fluid flows, reservoir engineering, mechanical engineering, semiconductor device analysis, nuclear reaction models, and electric circuit simulation. These matrices can be huge, up to millions of degrees of freedom. Modern improvements include GMRES and BI-CGSTAB.*

Prepared by Dianne P. O'Leary.

Bibliography

- [1] Magnus R. Hestenes and Eduard Stiefel, Methods of Conjugate Gradients for Solving Linear Systems, *J. Res. Natl. Bur. Stand.* **49**, 409-436 (1952).
- [2] Magnus R. Hestenes and John Todd, *NBS-INA—The Institute for Numerical Analysis—UCLA 1947-1954*, NIST Special Publication 730, National Institute of Standards and Technology, Gaithersburg, MD (1991).
- [3] Eduard Stiefel, Über einige Methoden der Relaxationsrechnung, *Z. Angew. Math. Phys.* **3**, 1-33 (1952).
- [4] M. R. Hestenes, Iterative Methods for Solving Linear Equations, NAML Report 52-9, July 2, 1951, NBS, Los Angeles, CA. Reprinted in *J. Optim. Theory Appl.* **11**, 323-334 (1973).
- [5] Cornelius Lanczos, Solution of Systems of Linear Equations by Minimized Iterations, *J. Res. Natl. Bur. Stand.* **49**, 33-53 (1952).
- [6] Cornelius Lanczos, An Iteration Method for the Solution of the Eigenvalue Problem of Linear Differential and Integral Operators, *J. Res. Natl. Bur. Stand.* **45**, 255-282 (1950).

- [7] Magnus Hestenes, *Conjugacy and Gradients*, Princeton History Conference, Summer 1987.
- [8] J. K. Reid, On the Method of Conjugate Gradients for the Solution of Large Sparse Systems of Linear Equations, in *Large Sparse Sets of Linear Equations*, J. K. Reid (ed.), Academic Press, New York (1971) pp. 231-254.
- [9] Gene H. Golub and Dianne P. O'Leary, Some History of the Conjugate Gradient and Lanczos Algorithms: 1948-1976, *SIAM Rev.* **31**, 50-102 (1989).
- [10] A. Miele, An Appreciation of Professor M. R. Hestenes, *J. Optim. Theory Appl.* **14**, 445-451 (1974).
- [11] M. R. Hestenes, Applications of the Theory of Quadratic Forms in Hilbert Space to the Calculus of Variations, *Pacific J. Math.* **1**, 525-581 (1951).
- [12] J. Waldvogel, U. Kirchgraber, H. R. Schwarz, and P. Henrici, Eduard Stiefel (1909-1978), *Z. Angew. Math. Phys.* **30**, 133-136 (1979).
- [13] Konrad Zuse, Die Rolle der ETH bei der Computerentwicklung, *Z. Angew. Math. Phys.* **30**, 399-403 (1979).
- [14] Eduard Stiefel, Comments on the Bibliography, *Z. Angew. Math. Phys.* **30**, 141-142 (1979).
- [15] Top 10 Algorithms of the Century, *Comput. Sci. Eng.* **2** (1), (2000).

Computer Development at the National Bureau of Standards

The first fully operational stored-program electronic computer in the United States was built at the National Bureau of Standards. The Standards Electronic Automatic Computer (SEAC) [1] (Fig. 1.) began useful computation in May 1950. The stored program was held in the machine's internal memory where the machine itself could modify it for successive stages of a computation. This made a dramatic increase in the power of programming.

Although originally intended as an "interim" computer, SEAC had a productive life of 14 years, with a profound effect on all U.S. Government computing, the extension of the use of computers into previously unknown applications, and the further development of computing machines in industry and academia.

In earlier developments, the possibility of doing electronic computation had been demonstrated by Atanasoff at Iowa State University in 1937. The ENIAC was completed in 1946 at the Moore School of the University of Pennsylvania, but programming in that machine consisted of setting appropriate switches and plug connections. The ENIAC had demonstrated that

individual computations could be performed at electronic speed, but the instructions (the program) that drove these computations could not be modified and sequenced at the same electronic speed as the computations. Other early computers in academia, government, and industry, such as Edvac, Ordvac, Illiac I, the Von Neumann IAS computer, and the IBM 701, would not begin productive operation until 1952.

In 1947, the U.S. Bureau of the Census, in cooperation with the Departments of the Army and Air Force, decided to contract with Eckert and Mauchly, who had developed the ENIAC, to create a computer that would have an internally stored program which could be run at electronic speeds. Because of a demonstrated competence in designing electronic components, the National Bureau of Standards was asked to be technical monitor of the contract that was issued, to the company that became the Remington Rand Corporation, for the development of the first commercial computer, the Univac. Actually, there were three machines, two for the military and one for the Census Bureau.



Fig. 1. SEAC, showing the magnetic tapes and wire cartridges, the operators console, and the racks of logic circuitry.

It became clear during 1948 that unexpected technical difficulties would delay completion of the Univacs. The machine for the Office of the Air Comptroller was primarily for use by George Dantzig, noted for his work on Linear Programming applied to economic problems. He urged the Air Force to contract with NBS for the development of an interim machine which would serve multiple purposes. Furthermore, the Bureau was in need of a computer for its own scientific research. Consequently, NBS began development, in its own laboratory, of an interim machine for use by NBS, the Army and Air Force, and the Census Bureau, which wished to test automatic methods on the 1950 Census. The interim machine at NBS was completed and put into continuous operation in May 1950, a year before the first commercial machine was delivered. It was originally called the Standards Eastern Automatic Computer to distinguish it from the Standards Western Automatic Computer still under development at the NBS Institute for Numerical Analysis in Los Angeles.

In the early years of its use, SEAC was operated 24 hours per day, 7 days per week. During this time four different kinds of demand were made on the machine. It was used by mathematicians from NBS and many other institutions to do the calculations that spurred the advance of numerical analysis. It was also used by the engineering staff of the Electronic Computers Laboratory to develop new components and to expand the capabilities of SEAC. A maintenance staff kept constant watch on the 12,000 diodes and over 1000 vacuum tubes by doing diagnostic testing. Finally, with the support of other agencies, NBS developed entirely new uses for computers and tested these uses on SEAC. Despite these competing demands, SEAC achieved reliable operation 77 % of the time during its critical first three years of operation. This was both a surprise and a source of encouragement to the young field of computer development.

The mathematical applications of SEAC were well represented by the publication of the NBS *Handbook of Mathematical Functions* [2] (which is separately described in this volume). One major calculation carried out dealt with nuclear energy. The early engineering and maintenance developments are described in an NBS Circular published in 1955: *Computer Development (SEAC and DYSEAC) at the National Bureau of Standards* [1]. It consists of an introduction by S. N. Alexander, the Chief of the Electronic Computer Laboratory which developed SEAC, and reprints of eight papers by NBS staff which were previously published in various journals and computer conference proceedings. Their titles give an idea of the scope of NBS contributions to computer design.

Foreword, A. V. Astin

Introduction, S. N. Alexander

SEAC, S. Greenwald, S. N. Alexander, and Ruth C. Haueter

Dynamic circuitry techniques used in SEAC and DYSEAC, R. D. Elbourn and R. P. Witt

DYSEAC, A. L. Leiner, S. N. Alexander, and R. P. Witt

System design of the SEAC and DYSEAC, A. L. Leiner, W. A. Notz, J. L. Smith, and A. Weinberger

High-speed memory development at the National Bureau of Standards, R. J. Slutz, A. W. Holt, R. P. Witt, and D. C. Friedman

Input-output devices for NBS computers, J. L. Pike and E. L. Ainsworth

Operational experience with SEAC, J. H. Wright, P. D. Shupe, Jr., and J. W. Cooper

SEAC-Review of three years operation, P. D. Shupe, Jr. and R. A. Kirsch

The Greenwald, Alexander, and Haueter paper describes the organization of SEAC from the block diagram level down to the circuitry level. It exhibits pictures of the tens of thousands of hand-constructed components which today are manufactured by automatic methods. To us today, it seems even more amazing than it did in 1950 that the thing could work at all!

This circuitry using diodes, vacuum tubes, and pulse transformers is described in the Elbourn and Witt paper.

The memory of SEAC initially consisted of what we would today describe as 3072 bytes, (not kilobytes or megabytes!). This memory, in the form of acoustic pulses in mercury columns, is described in the paper by Slutz, Holt, Witt, and Friedman, as are subsequent developments of a higher speed electrostatic memory and a memory design using individual components for each bit.

Because of the very limited memory capacity of SEAC, it was important to be able to store information on external media. These media were also used for feeding data and programs to SEAC. The paper by Pike and Ainsworth describes the various magnetic and paper tape media which served this purpose. One magnetic device was an adapted office dictating machine, modified to store digital information. Each programmer had one of these wire cartridges on which the whole history of his or her programming experience would be stored. These wire cartridges still exist today, but there are no devices to read them, thereby losing to history much of the detailed early experience on the first computer!

The two papers by Wright, Shupe, and Cooper and by Shupe and Kirsch describe how SEAC was maintained in productive operation despite the fact that failure in any one of the tens of thousands of components or solder connections would render the computer inoperative, or so it was believed. Actually, after about ten years of ostensibly fault-free operation, it was discovered by Kirsch that there had been a wiring error in SEAC from the beginning of its useful life. A program written in a certain way would have failed, but the conditions for this failure had never occurred in the many years of normal operation. Computers of today are not as reliable as SEAC aspired to be, so we use “workarounds” to live with errors.

Two important lessons learned from the design of SEAC were incorporated in the design of DYSEAC in 1953. The reliability of SEAC’s components led to the use of similar components in DYSEAC, and new kinds of logical organization were also incorporated. These are described in the two papers by Leiner, Alexander, and Witt and by Leiner, Notz, Smith, and Weinberger.

DYSEAC was built in movable trailers for the U.S. Army and is believed to be the first computer to use printed circuits. In the short time after its construction at NBS, before it was removed by the sponsoring organization, it was possible to demonstrate some of its important properties. It had extensive abilities for real-time interaction with outside devices. One of these was SEAC itself, which was able to interrupt computations on DYSEAC and send data into files on DYSEAC without disruption of the DYSEAC computation. This was an early example of hardware-based time-sharing. Other examples that ultimately led to industrial process control were first demonstrated on the DYSEAC.

The last of the four kinds of uses of SEAC was the development of entirely new applications for computers. The first uses of SEAC (and indeed most computers) were for mathematical calculations. Soon thereafter it was recognized that computers, as symbol manipulators, could also process alphabetical information. This led to so-called business data processing. But the ready availability of SEAC for innovation without the need for commercial motivation encouraged its use beyond these two conventional areas. Two examples of the many such innovative areas started on SEAC were Image Processing and Chemical Structure Searching.

In 1957 the first picture was fed into a computer when a rotating drum scanner was connected to SEAC [3]. This project demonstrated that it was possible to perform image processing operations on scanned pictures, using the (for that time) great processing speed of the computer. Progress in scanning technology can be seen in the difference between one of the first scans and a modern one (Fig. 2). Among the many disciplines



Fig. 2. Father and daughter—two scans separated by 40 years and storage requirements in the ratio of 1400:1.

impacted at NBS by this new field of image processing were metallurgy [4], character recognition [5], and criminology [6]. Today, this technology, first started on SEAC, allows us to do CAT scans in medicine, receive satellite images from space, scan bar codes in grocery stores, and do desktop publishing [7].

Experience with non-numerical processing techniques led to the realization that different kinds of data structures could be manipulated with SEAC. One of these was the structural diagram used in organic chemistry. In the process of examining new patent applications, the U. S. Patent Office needed to search files of chemical compounds. Previously, chemical names had been the only means of representing compounds, but this type of search was not very satisfactory owing to inconsistent nomenclature. It was shown [8,9] with the use of SEAC that structural diagrams could be represented in digital form and searched on the computer, thereby finding records that could not have been found

using nomenclature alone. Chemical structure searching is now a multimillion dollar industry which plays a major role, for example, in design of new drugs.

The rapidity with which SEAC and its descendants influenced a wide variety of scientific, commercial, and even intellectual disciplines encouraged the early pioneers to believe that “Nothing will be restrained from them which they have imagined to do” [10]. Many people still believe that today.

Prepared by Russell A. Kirsch.

Bibliography

- [1] A. V. Astin (ed.), *Computer Development (SEAC and DYSEAC) at the National Bureau of Standards, Washington, DC*, National Bureau of Standards Circular 551, U.S. Government Printing Office, Washington, DC (1955).
- [2] Milton Abramowitz and Irene A. Stegun (eds.), *Handbook of Mathematical Functions with Formulas, Graphs, and Mathematical Tables*, National Bureau of Standards Applied Mathematics Series 55, U. S. Government Printing Office, Washington, DC, June 1964.
- [3] R. A. Kirsch, L. Cahn, L. C. Ray, and G. H. Urban, Experiments in processing pictorial information with a digital computer, *Proceedings of the Eastern Joint Computer Conference*, Dec. 9-13, 1957, Institute of Radio Engineers, New York (1958).
- [4] G. A. Moore and L. L. Wyman, Quantitative Metallography with a Digital Computer, Application to a Nb-Sn Superconducting Wire, *J. Res. Natl. Bur. Stand.* **67A**, 127-147 (1963).
- [5] Mary Elizabeth Stevens, *Automatic Character Recognition, A State-of-the-Art Report*, NBS Technical Note 112, National Bureau of Standards, Washington, DC, May 1961.
- [6] J. H. Wegstein, *A Semi-Automated Single Fingerprint Identification System*, NBS Technical Note 481, National Bureau of Standards, Washington, DC (1969).
- [7] Russell A. Kirsch, SEAC and the Start of Image Processing at the National Bureau of Standards, *IEEE Ann. Hist. Comput.* **20** (2), 7-13 (1998).
- [8] Louis C. Ray and Russell A. Kirsch, Finding Chemical Records by Digital Computers, *Science* **126**, 814-819 (1957).
- [9] Herbert R. Koller, Ethel C. Marden, and Harold Pfeffer, The Haystaq System: Past, Present, and Future, in *Proceedings of the International Conference on Scientific Information, Washington, DC, Nov. 16-21, 1958*, National Academy of Sciences, Washington, DC (1959) pp. 1143-1179.
- [10] Genesis, 11:6.

Thermal Converters as AC-DC Transfer Standards for Current and Voltage Measurements at Audio Frequencies

Francis L. Hermach's paper [1] launched the field of ac-dc thermal transfer metrology, which forms the basis for ac voltage and current measurement and calibration throughout the world. It laid the foundation for the techniques of ac-dc transfer and provided the first theoretical basis for the thermal transfer structures used in all national measurement institutes (NMIs, i.e., counterpart organizations to NIST) today. Hermach was the first to realize the very large improvement in capability that is possible when electrothermic elements are used as ac-dc transfer devices instead of relying on absolute instruments as had been the practice previously. The impact of the paper was, therefore, nothing less than the creation of an area of electrical metrology that continues to provide the national and working standards on which the world's NMIs base their ac voltage and current calibrations.

Although the paper contains construction details and experimentally determined characteristics for new instrumentation developed at NBS, it also has over five pages of very detailed electrical, thermal, and thermoelectric modeling for the critical elements in the newly proposed thermal transfer standards. It contains the very first solution to the steady state temperature distribution in an ac-dc thermal transfer instrument and includes effects of Peltier and Thomson heating and low frequency error due to failure to average the applied signal.

This ground-breaking publication is the most cited work in the ac-dc thermal transfer field. It has been and continues to be cited by scientists and engineers in NMIs all over the world and is regularly mentioned for providing the basis of new calibration standards. Virtually every major NMI has a copy in its technical library. The paper is still disseminated routinely to metrologists who require a solid foundation in the field of thermal transfer measurements.

Hermach's paper made a major contribution by proposing and describing the use of electrothermic instruments as transfer devices, as well as clearly delineating the major physics elements limiting their performance, thus creating a whole new area of calibration standards.

AC voltages and currents in the frequency range from low audio to hundreds of megahertz are measured most accurately by comparison to dc standards using ac-dc thermal transfer instruments. AC-DC thermal transfer structures were first applied in the audio frequency range and later at radio frequencies [2] for difference measurements of voltage, current, and power. Hermach and the staff of the NBS Electricity Division produced important developments including the first description of coaxial transfer standards and the first transmission-line analysis of such structures [3].

In general, the rate of transformation of energy from electrical to thermal form in thermal converters is proportional to the root-mean-square (rms) values of current and voltage. The heater temperature is a function of the square of the heater current even if the constants in the defining equation that describes the underlying physics vary with temperature or time. Since the response of thermal converters is calibrated on direct current at the time of use, ac-dc transfers are possible with little decrease in accuracy from drift or external temperature influences.

Traditional thermal converters contain wire heaters or thin metal heater structures. The temperature of the heater is typically monitored with one or more thermocouples, also made of wire or thin metal film. The best-performing primary standards usually contain many thermocouples in an arrangement that minimizes ac-dc difference by reducing both heater temperature and thermal gradients. Current research at NIST includes two areas directed at new thermal converters suitable for both primary and working standards.

Multi-junction thermal converters (MJTCs) are used in very high-accuracy ac-dc difference metrology because they have very small ac-dc differences, follow the rms law of excitation, and produce high output emfs. MJTCs traditionally have been fabricated from wire heater resistors and thermocouples. The project to develop thin-film MJTCs (FMJTCs) involves the use of micro-machining of silicon and photo-lithography on thin films to produce high-performance thermal transfer standards. Multilayer FMJTCs have been designed, fabricated, and tested at NIST by J. R. Kinard, D. B. Novotny, and D. X. Huang, and new improved converters are under development [4].

The basic elements of the devices are a thin-film heater on a thin dielectric membrane, a silicon frame surrounding and supporting the structure, and thin-film thermocouples positioned with hot junctions near the heater and cold junctions over the silicon. Carefully selected materials in new thermal designs are required, along with very accurate dimensioning of the heater and thermocouples. The heater and thermocouples are sputter deposited and patterned with photolithography. Contributions to ac-dc difference from the Thomson effect and other effects are further reduced by the appropriate choice of heater alloy.

Integrated micropotentiometers are thermal transfer devices that contain FMJTCs and thin-film output resistors fabricated as an integrated structure on the same silicon chip. The figure shows an integrated micropotentiometer including the FMJTC structure. New versions of the FMJTCs and integrated micropotentiometers are under development that include new membrane materials and vacuum packaging, with the help of novel etching techniques such as front and back surface etching.

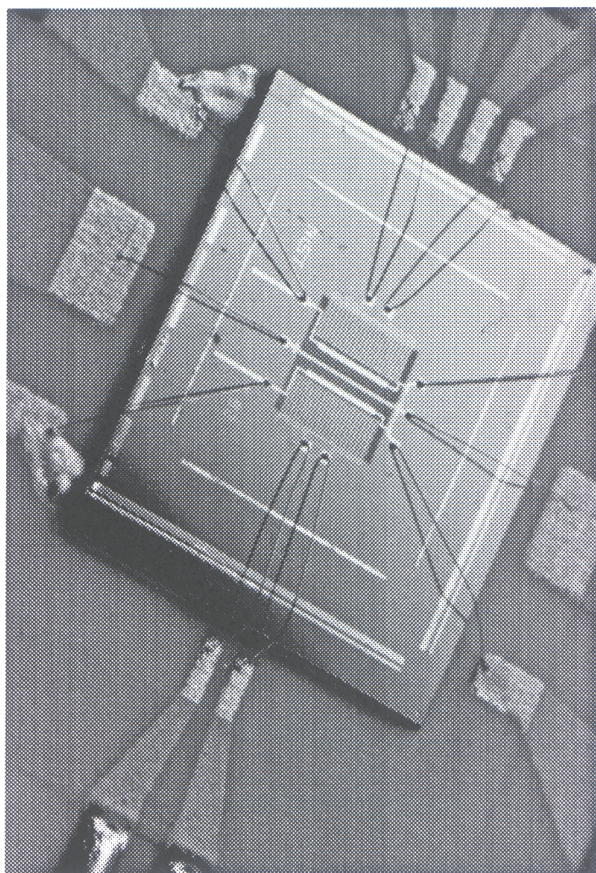

Fig. 1. Integrated micropotentiometer including the thin-film multi-junction thermal converter (FMJTC) structure.

At audio frequency, thermal and thermoelectric effects ultimately limit the measurement uncertainty in conventional room-temperature thermal converters. Heater powers as high as a few tens of milliwatts and temperature differences as high as 100 K are common in some thermal converters. To reduce these effects and to achieve very high temperature sensitivity, a novel sensor employing a superconducting resistive-transition edge thermometer is being developed at NIST by C. D. Reintsema, E. N. Grossman, J. A. Koch, J. R. Kinard, and T. E. Lipe [5,6]. Since the new converter operates at temperatures below 10 K and is mounted on a platform with precise temperature control and very small temperature gradients, the thermal and thermoelectric errors are potentially quite small. Because of the very high temperature sensitivity of the superconducting transition, this converter also offers the possibility of direct thermal transfer measurements at very low signal levels.

This transfer standard consists of a signal heater, trim heater, and temperature sensor all mounted on a temperature-stabilized platform. The sensor resistance is measured by an ac resistance bridge, and the temperature of the assembly is held constant by the closed loop application of power to the trim heater. A NbTa thin-film meander line is used as the thermal sensor, and it is thermally biased to operate within its superconducting-resistive transition region. The signal heater in the prototype device is a $7\ \Omega$ thin-film meander line and the trim heater is a $450\ \Omega$ PdAu thin-film meander line, both adjacent to the detector on the silicon substrate. To ensure temperature stability, the entire converter assembly is mounted on a second platform controlled at a slightly lower temperature. This intermediate stage is thermally isolated, and controlled by a second ac resistance bridge using another transition edge sensor and heater.

Using this new cryogenic converter, measurements have been made at signal power levels of a microwatt, which is around 1000 times lower than is possible with room-temperature converters. Characterization using a fast-reversed-dc source has shown that the thermoelectric errors are presently in the $1\ \mu\text{V}/\text{V}$ to $2\ \mu\text{V}/\text{V}$ range. These early results are encouraging, but considerable improvement both in the resistance bridge performance and in the input transmission line will be necessary for this new device to be a candidate for consideration as a primary standard.

Prepared by J. R. Kinard, Jr., N. B. Belecki, and J. F. Mayo-Wells, based on excerpts from the paper The Ampere and Electrical Units [7], authored by members of the Electricity Division.

Bibliography

- [1] Francis L. Hermach, Thermal Converters as AC-DC Transfer Standards for Current and Voltage Measurements at Audio Frequencies, *J. Res. Natl. Bur. Stand.* **48**, 121-138 (1952).
- [2] F. L. Hermach and E. S. Williams, Thermal voltage converters for accurate voltage measurements to 30 megacycles per second, *Trans. Am. Inst. Electr. Eng., Part 1* **79**, 200-206 (1960).
- [3] Joseph R. Kinard, Thomas E. Lipe, Clifton B. Childers, and Svetlana Avramov-Zamurovic, Comparison of high voltage thermal converter scaling to a binary inductive voltage divider, in *1998 Conference on Precision Electromagnetic Measurements: Digest*, Institute of Electrical and Electronics Engineers, New York (1998) pp. 381-382.
- [4] J. R. Kinard, D. X. Huang, and D. B. Novotny, Performance of multilayer thin-film multijunction thermal converters, *IEEE Trans. Instrum. Meas.* **44**, 383-386 (1995).
- [5] Carl D. Reintsema, Erich N. Grossman, Jonathan A. Koch, Joseph R. Kinard, and Thomas E. Lipe, AC-DC transfer at cryogenic temperatures using a superconducting resistive transition-edge temperature sensor, in *IMTC Proceedings: IMTC '97, IEEE Instrumentation and Measurement Conference: Sensing, Processing, Networking, Vol. 1*, Institute of Electrical and Electronics Engineers, New York (1997) pp. 726-730.
- [6] Carl D. Reintsema, Joseph R. Kinard, Thomas E. Lipe, Jonathan A. Koch, and Erich N. Grossman, Thermal transfer measurements at microwatt power levels, in *1998 Conference on Precision Electromagnetic Measurements: Digest*, Institute for Electrical and Electronics Engineers, New York (1998) pp. 171-172.
- [7] R. E. Elmquist, M. E. Cage, Y-H. Tang, A-M. Jeffery, J. R. Kinard, R. F. Dziuba, N. M. Oldham, and E. R. Williams, The Ampere and Electrical Units, *J. Res. Natl. Inst. Stand. Technol.*, January-February (2001).

Selected Values of Chemical Thermodynamic Properties

The theoretical framework of thermodynamics was well established by the time NBS was founded, and certain important applications, such as improving the efficiency of steam engines, had been demonstrated. However, the broad application of thermodynamics to the design and control of industrial processes had to await the accumulation and organization of a large amount of experimental data, as well as theoretical contributions from quantum mechanics and statistical mechanics. The appearance of *Selected Values of Chemical Thermodynamic Properties* [1] in 1952 marked a significant milestone in this process. This book represented the culmination of 20 years of work by Frederick D. Rossini and coworkers in evaluating and systematizing the data that had appeared in the world literature on thermochemistry. It tabulated accurate values of the thermodynamic properties of all inorganic and simple organic compounds that had been investigated in a format that allowed prediction of the outcome of many thousands of chemical reactions. Such calculations, which indicate whether a reaction will take place and, if so, the extent of reaction and amount of heat released or absorbed, are immensely important in research and engineering.

Selected Values, which was often referred to simply as “Circular 500” after its NBS publication designation, presented recommended values of the enthalpy (heat) of formation, Gibbs energy of formation, entropy, and heat capacity of individual chemical compounds in different physical states (solid, liquid, gas, or aqueous solution). All values were reduced to standard state conditions, defined by parameters such as temperature (25 °C) and pressure (one standard atmosphere). Since the laws of thermodynamics require that the change in properties such as energy and entropy cannot depend on the path followed in going from an initial to a final state—otherwise one could build a perpetual motion machine—the net change in thermodynamic properties in a chemical reaction can be calculated by addition and subtraction of the standard state values for the substances taking part in the reaction. This allows a simple prediction of whether the reaction will occur at all and, if it does, whether it will go to completion. In intermediate situations, one can obtain a quantitative measure of the extent of reaction from the equilibrium constant, which is easily calculated from the tabulated standard state



Fig. 1. Frederick D. Rossini.

values. Finally, most chemical changes involve either an absorption or release of heat, and the amount of this heat may be calculated from the same data. Thus *Selected Values* provided an extremely powerful tool for predicting the course of chemical reactions, a goal of chemists since the earliest days of the science.

The book itself was 822 pages in length and covered about 5000 chemical species. It was divided into two parts, the first dealing with the thermodynamic properties in a particular physical state and the second with the change in properties in transitions between states (such as melting and vaporization). All data were internally consistent, in the sense that all physical and thermodynamic relations existing between different properties for the same substance, or the same property for different substances, were satisfied by the tabulated values. The table layout in Circular 500 became the norm for thermodynamic tabulations throughout the world.

The preparation of *Selected Values of Chemical Thermodynamic Properties* required analyzing data from thousands of literature references appearing over the previous century, selecting the most reliable values in the judgment of the evaluators, and then optimizing this massive database to derive a “best set” of standard state values. Much of the data had to be corrected for changes in temperature scales, unit definitions, atomic weights, and other auxiliary data that can affect the thermodynamic properties. Shrewd detective work was sometimes required; for example, when a nineteenth-century chemist had failed to report the ambient temperature during a measurement, newspaper archives were consulted in order to estimate the laboratory temperature at the time. Since there was considerable redundancy in the data, related data sets were subjected to statistical analysis using weighting factors based on the evaluator’s appraisal of the accuracy of each measurement. In this way an internally consistent set of standard state values was derived that gave the best fit to the much larger database of experimental measurements. It was a remarkable achievement that Rossini and his group did this before the advent of computers and before the term “database” was even coined. They anticipated by many years the process of obtaining the best fit for a large set of data of varying accuracy—a procedure which is now commonplace in all scientific fields.

Subsets of these data had been released in loose-leaf form to universities, industrial users, and others in the 1947-1950 period. The complete tables received wide distribution as soon as they appeared in 1952 and went out of print six years later. Demand continued, and NBS reprinted the book in 1961. *Selected Values* became a standard fixture in physical chemistry laboratories. A generation of chemistry students used the book to analyze their laboratory data, and researchers in many fields used it to plan their experiments. Chemical engineers used it in various stages of process design. The late Henry Eyring, one of the major figures of twentieth century chemistry, once asserted that Circular 500 saved U.S. industry enough money to pay the entire cost of NBS since its founding. Unfortunately, it was difficult to document that claim in a way that would help NBS budget requests!

One of the early applications of *Selected Values* was in the U. S. rocket program, which went into full gear shortly after its publication. Chemical thermodynamics was the key factor in boosting the performance of rocket engines, and there was a major effort to find new fuels and oxidizers as space competition with the Soviet Union intensified. Many chemical reactions involving exotic compounds were explored in the process of searching for ways to increase rocket thrust. The data in *Selected Values* were used to screen prospective

reactions and identify those that were promising enough to warrant experimental investigation. A large DOD (and later NASA) program was started in the mid-1950s to extend the thermodynamic tables to the very high temperatures involved in rocket engines (as noted, the data in *Selected Values* are at room temperature). This spawned the *JANAF* (Joint Army-Navy-Air Force) *Thermochemical Tables* [2], a publication project in which many NBS staff members took part. The *JANAF Tables*, which are now in their fourth edition [3], have had a major impact in combustion research and many other areas of science and engineering; they have consistently been among the best sellers of the NIST Standard Reference Data program.

Rossini left NBS shortly before the publication of Circular 500 to become Chairman of the Chemistry Department at Carnegie Institute of Technology, but the work was carried on by two of the other authors, Donald Wagman and William Evans. A full update had been planned for the early 1960s, but the task proved to be far greater than expected. An explosion of the literature reporting new thermodynamic data took place as a result of greater government funding, an increase in the number of doctoral students, and, in particular, the introduction of automated instrumentation for calorimetric measurements. When the Standard Reference Data program was established at NBS in the mid-1960s, the thermodynamic tables project was designated the Chemical Thermodynamics Data Center and became a cornerstone of the new program. Partial updates to Circular 500 were issued between 1965 and 1981 in the *NBS Technical Note 270* series [4] as work was completed on specific parts of the periodic table. Digital computers became available during this period, which greatly expedited the process of fitting the reaction data to obtain the best set of standard state properties, but considerable human effort was still required to assess the accuracy of the reported measurements. A complete revision of Circular 500, entitled *The NBS Tables of Chemical Thermodynamic Properties* [5], was finally published in 1982 as a supplement to the *Journal of Physical and Chemical Reference Data*. This book has become a fixture in chemistry libraries and laboratories, and even today receives 150 or more citations each year. The data from *The NBS Tables* have now been converted to electronic form and included in the *NIST Chemistry WebBook*, which receives heavy use on the NIST Internet site [6].

Tabulation of thermodynamic data has continued as an active field at NBS/NIST and has been broadened from the primarily inorganic thrust of Circular 500 to more complex organic and biochemical substances. Extensive tables of heat capacity and entropy data on organic compounds have been published by

Eugene Domalski and colleagues. Robert Goldberg has led a program to evaluate data on the thermodynamics of enzyme-catalyzed reactions. Several data compilations on aqueous solutions have also appeared.

The data from Circular 500 and its updates and offspring have circulated widely beyond the original publications. It is fair to say that most tabulations of chemical thermodynamic properties in textbooks, popular handbooks, and online databases have been extracted from the NBS/NIST publications described here. More recently, these data have been incorporated in software packages for engineering design applications and environmental modeling.

Frederick D. Rossini came to NBS in 1928 after completing his Ph.D. at Berkeley, which was at that time the leading center for chemical thermodynamics research in the United States. He established an experimental program at NBS for measuring heats of combustion and other calorimetric properties with high accuracy. By drawing upon expertise in the Electricity and Heat Divisions of NBS, he advanced the state of the art in this type of measurement. His careful attention to the purification of his samples was another factor in achieving a new level of accuracy. Many of his measurements of the heat of formation of basic chemical compounds are still the best available. This high accuracy in calorimetric measurements provided new insights into the structure of organic compounds, for example by giving precise values for the very small energy differences between different geometric configurations of a complex molecule. Ernest Eliel, a distinguished organic chemist who used Rossini's data in studying the conformations of cyclohexane, likened this feat to measuring the mass of a boat captain by first weighing the boat with the captain aboard, then weighing it without the captain, and taking the difference [7].

In addition to his contributions to basic chemistry, Rossini had a keen interest in applying thermodynamics to industrial processes. In 1934 he became director of a project on thermodynamic properties of hydrocarbons, conducted at NBS under sponsorship of the American Petroleum Institute (API). The measurements on energy changes in isomerization of hydrocarbons carried out under this project laid the foundation for improving petroleum refining methods to give gasoline of higher quality. He initiated a program to prepare very pure samples of the pertinent hydrocarbons, which were widely distributed and used in other laboratories for a variety of physical measurements. These were, in effect, Standard Reference Materials, although there was no formal SRM program at that time. During World War II this work on hydrocarbons played a critical role in the development of high octane aviation fuels.

In parallel with his experimental research programs, he developed an early interest in organizing and systematizing thermodynamic data. In 1936 he published *The Thermochemistry of the Chemical Substances* [8], co-authored by F. R. Bichowsky, a book which was a precursor to Circular 500. The research program on hydrocarbons led to the establishment in 1942 of API Project 44, under which data sheets were prepared on the physical and thermodynamic (and later spectral) properties of hundreds on hydrocarbons and related compounds. These data were published in 1947 as NBS Circular 461, *Selected Values of Properties of Hydrocarbons and Related Compounds* [9], which became a basic source of design data for the oil industry.

After leaving NBS in 1950, Rossini served as Chairman of the Chemistry Department at Carnegie Institute of Technology until 1960. While there he continued to oversee the API tables project, which he had brought from NBS. This project evolved into the Thermodynamics Research Center (TRC), under the direction of Bruno Zwolinski, and later moved to Texas A&M University. TRC continued to provide data to the chemical and oil industries and became one of the affiliated data centers of the NBS Standard Reference Data program. In an interesting twist, TRC relocated from Texas A&M to the NIST Boulder Laboratories in 2000, thus coming full circle from its origin at NBS almost 60 years before as API Project 44.

Rossini himself moved from Carnegie to Notre Dame in 1960 as Dean of Science and later Vice President for Research. After his retirement from Notre Dame in 1971, he was given a part-time appointment at Rice University, where he returned to experimental measurements of thermodynamic properties. He later retired to Florida and died in 1990 at the age of 91.

Rossini's honors included the National Medal of Science (awarded in 1977), membership in the National Academy of Science, the Priestly Medal (highest award of the American Chemical Society), Department of Commerce Gold Medal, and countless others. He chaired the Commission on Thermodynamics of the International Union of Pure and Applied Chemistry (IUPAC) for 15 years; this service was recognized by the establishment of the Rossini Lectureship, now awarded every 2 years to an outstanding thermodynamicist. In the 1960s he was the prime mover in founding CODATA, the Committee on Data for Science and Technology of the International Council of Scientific Unions, and served as its first President from 1966 to 1970. CODATA has proved to be a valuable forum for the NBS/NIST Standard Reference Data program; many cooperative projects have been

organized under its umbrella, and two SRD Directors, David Lide and John Rumble, have followed Rossini as CODATA presidents.

Don Wagman and Bill Evans maintained the high quality of the NBS work on thermodynamic tables for another 30 years after Rossini left, culminating in the publication of the previously mentioned *NBS Tables of Chemical Thermodynamic Properties* [5]. Under the auspices of CODATA they established a fruitful collaboration with thermodynamicists in the Soviet Union. This project on Key Values for Thermodynamics [10], which included contributions from several other countries as well, led to agreement on an internationally accepted set of values for the properties of certain key compounds that play a ubiquitous role in thermodynamic calculations. In addition to the importance of the standardization effort, the project promoted significant human contacts between scientists during some of the most difficult years of the cold war.

The appearance of *Selected Values of Chemical Thermodynamic Properties* established NBS as the world authority on thermodynamic properties of chemical substances. This publication and its successors have had a broad impact on research, education, and industry. It ushered in a period of 50 years of NBS leadership in providing reliable thermodynamic data to the scientific and engineering communities.

Prepared by David R. Lide.

Bibliography

- [1] Frederick D. Rossini, Donald D. Wagman, William H. Evans, Samuel Levine, and Irving Jaffe, *Selected Values of Chemical Thermodynamic Properties*, Circular of the National Bureau of Standards 500, U.S. Government Printing Office, Washington, DC (1952).
- [2] D. R. Stull and H. Prophet, *JANAF Thermochemical Tables, Second Edition*, Nat. Stand. Ref. Data Ser., Nat. Bur. Stand. (U.S.), 37 (1971).
- [3] Malcolm W. Chase, Jr., *NIST-JANAF Thermochemical Tables, Fourth Edition*, *J. Phys. Chem. Ref. Data*, Monograph 9 (1998).
- [4] Donald D. Wagman, William H. Evans, Vivian B. Parker, Iva Halow, Sylvia M. Bailey, and Richard H. Schumm, *Selected Values of Chemical Thermo-Dynamic Properties*, Nat. Bur. Stand. (U.S.) Tech. Note 270-3 (1968). This included Tech. Note 270-1 (1965) and 270-2 (1966); numbers 4 through 8 in the Tech. Note 270 series appeared 1969 through 1981.
- [5] Donald D. Wagman, William H. Evans, Vivian B. Parker, Richard H. Schumm, Iva Halow, Sylvia M. Bailey, Kenneth L. Churney, and Ralph L. Nuttall, *The NBS Tables of Chemical Thermodynamic Properties*, *J. Phys. Chem. Ref. Data*, Vol. 11, Suppl. 2 (1982).
- [6] W. G. Mallard and P. J. Linstrom, eds., *NIST Chemistry Web Book*, NIST Standard Reference Database Number 69, National Institute of Standards and Technology, Gaithersburg MD (1998) (<http://webbook.nist.gov>).
- [7] E. L. Eliel, *Biographical Memoirs, Volume 77, Frederick Dominic Rossini, 1899-1990*, National Academy Press, Washington, DC (1999).
- [8] Francis R. Bichowsky and Frederick D. Rossini, *The Thermochemistry of the Chemical Substances*, Reinhold Publishing Co., New York (1936).
- [9] Frederick D. Rossini, Kenneth S. Pitzer, William J. Taylor, Joan P. Ebert, John E. Kilpatrick, Charles W. Beckett, Mary G. Williams, and Helene G. Werner, *Selected Values of Properties of Hydrocarbons*, Circular of the National Bureau of Standards 461, U.S. Government Printing Office, Washington, DC (1947).
- [10] J. D. Cox, D. D. Wagman, and V. A. Medvedev, *CODATA Key Values for Thermodynamics*, Hemisphere Publishing Corp., New York (1989).

Applied Inorganic Analysis

The 1929 first edition of *Applied Inorganic Analysis* [1] was a classic of its time, commonly referred to as the “analyst’s bible.” Co-authored by two Chief Chemists of the National Bureau of Standards, Gustav Ernst Fredrik Lundell and William Francis Hillebrand, the book represented the authors’ comprehensive knowledge and broad practical experience. The 1953 second edition [2] was a thorough revision by Harry Aaron Bright and James Irvin Hoffman, who were Chief of the Analytical Chemistry Section and Assistant Chief of the Chemistry Division, respectively. Both editions of *Applied Inorganic Analysis* presented critical expositions of the chemical methods of analysis as applied to a broad range of complex matrices including metals, alloys, rocks, minerals, ores, ore concentrates, and glass. Each of the two editions stood alone as the authoritative single-volume reference for inorganic analysis for many years, and even today remains a valuable resource for pre-instrumental, classical methods of chemical analysis.

The story of the development of this remarkable book began in 1878 after the young American chemist William Francis Hillebrand completed a course in metallurgy and assaying at the mining academy in Freiberg, Germany. Fully intent on returning to America and impressed with the opportunities for young chemists as assayers, he took this course in order to supplement the training in mineral analysis that he had received from Bunsen, under whom he had earned his Ph.D., magna cum laude, at the University of Heidelberg, in 1875. Upon returning, he failed to find suitable work in the East, so he made his way in 1879 to Leadville, Colorado, where he became the third partner in a small assaying firm. Samuel F. Emmons, an occasional customer who was in charge of the Rocky Mountain Division of the newly formed United States Geological Survey (USGS), offered Hillebrand a job as a chemist. Considering this offer to be the opportunity of a lifetime, he quickly accepted, remaining in the Denver laboratory of USGS until 1885, when he was transferred to the Washington USGS laboratory. During his 28 years at USGS, Hillebrand made more than 400 complete (for that day) analyses of various rock samples [3].

In 1897 Hillebrand wrote a 50-page introduction to USGS Bulletin No. 148 [4] on the methods of analysis of silicate rocks, and this was translated into German and published in Germany in 1899. In 1900 this

material was rewritten and enlarged to 114 pages and issued as an independent document, USGS Bulletin No. 176 [5]. This brought a flock of commendatory letters, all confirming what L. V. Pirsson said: “We must now look upon you as the final authority in silicate analysis.” Another edition, which included the analysis of carbonate rocks, appeared in 1907 as Bulletin No. 305 [6]. This also was translated into German. An expanded edition was published in 1910 as Bulletin No. 422 [7], and the series culminated in 1919 as Bulletin No. 700 [8], a book of 285 pages. Even in the late nineteenth century and early twentieth century, the problem was not so much the lack of a suitable method for the final determination of an element as it was the lack of preceding separation methods that made an accurate determination possible, an occasional occurrence today. The significance of the analytical methods in this series of bulletins lay in Hillebrand’s success in developing a workable separation scheme for materials as complex as silicate and carbonate rocks.

This book is expected to remain the key reference work for highly accurate classical analytical methods, and although these methods are less commonly practiced today, analytical chemists will continue to appreciate the theory, chemical knowledge, and artistry inherent to their application.

In 1908, Hillebrand became the second Chief Chemist of the NBS. In 1917 he succeeded in bringing G. E. F. Lundell from Cornell, where Lundell was an assistant professor of chemistry. In 1923 Hillebrand and Lundell together began writing *Applied Inorganic Analysis*, a project that Hillebrand had been advised to do 10 years earlier. A 900-page book was planned in five parts: I. General Considerations; II. The Determination of the Elements; III. Silicate Rock Analysis; IV. Carbonate Rock Analysis; and V. Miscellaneous Methods of Analysis. Parts III and IV were essentially a reprint of USGS Bulletin 700. The aim of the book

throughout was to present analytical methods that would work in the real world of complex matrices. In the introduction to the first edition, Lundell stated, "A fair criticism of much of the work that has been published on methods for the determination of the elements is that a great deal is claimed on the basis of experiments that have been carried out in pure solutions, and very little, if anything, is said as to how the methods are to be applied or what results can be expected in analyses of the more or less complex materials in which the elements are found. . . . The aim throughout the book therefore has been to stress the preparation of the solution for the determination that is to be made, rather than to describe processes that can be used with certainty only in the specific applications for which they were devised." [2] Herein lies the true greatness of this book. In addition to the broad range of matrices covered, the separation methods are discussed and developed in such a way that the knowledgeable analyst can adapt them to other complex matrices. Unfortunately, Hillebrand died in 1925 at a time when only about one-third of the book had been completed. Lundell went on to complete the book in 1929 using Hillebrand's detailed notes and his own already considerable expertise

The second edition of *Applied Inorganic Analysis* was begun by Lundell in the late 1930s, at which time he was the accepted dean of the world's inorganic analytical chemists. However, he had not completed the book at the time of his death in 1950. The job of finishing the second edition was handed over to Harry Aaron Bright (then Chief of the Analytical Chemistry Section), and James Irvin Hoffman (then Assistant Chief of the Chemistry Division). It is indeed fortunate that the task fell to these two very capable men. Hoffman came to NBS in 1919 and distinguished himself with atomic weight determinations and the development of several significant chemical processes that were essential to the American effort in World War II. In 1938, he co-authored with Lundell *Outlines of Methods of Chemical Analysis* [9], which was intended as a companion volume to *Applied Inorganic Analysis*, and this book became a classic in its own right. Harry Aaron Bright joined the staff at NBS in 1913 as a laboratory assistant and worked closely with Lundell until Lundell retired in 1948. After Lundell's death, Bright became the recognized authority for the chemical analysis of metals and alloys in the U.S. Together, Bright and Hoffman made a thorough revision of the first edition of *Applied Inorganic Analysis*, adding significant new material, much of which had been developed at NBS by themselves together with R. K. Bell, R. Gilchrist, J. L. Hague, H. B. Knowles, B. F.

Scribner, J. K. Taylor, and E. Wichers. There was scarcely a page of the old edition that was not improved either by the omission of out-of-date material, by the inclusion of new references and footnotes, or by extensive additions to the text itself. For example, in the intervening years between the editions, R. Gilchrist had developed a completely new separation scheme for all the precious metals in the absence of gold, and this replaced the separation method of E. Wichers which had appeared in the first edition. In order to prevent the book from increasing to an unwieldy size, Part V of the first edition on the analysis of glass, bauxite, and other refractories was unfortunately omitted.

That the first edition had become a classic was made plain in the book reviews of the second edition. In his book review which appeared in the August 1953 issue of *Analytical Chemistry*, M. Gilbert Burford commented, "A new edition of this classic work should be welcomed by all chemists, and it is evident that the book will continue to be invaluable." He went on to say, "The authors' hope that 'here and there something helpful in solving a pressing problem may have been presented' should prove to be one of the classic understatements of the year." [10]. In his book review in the February 1954 issue of *The Analyst*, L. S. Theobald wrote: "In the reviewer's opinion, the work is the best of its kind. It is one to be used both in the library and at the bench, and it is indispensable to every chemist engaged in 'Applied Inorganic Analysis'." [11].

The book contains a wealth of durable information that continues to be relevant today. The basic material in Parts I and II on sampling and sample preparation has fundamental importance. Sections 4 and 5 of Part I contain common and special methods of separation, employing both inorganic and organic reagents, which will remain useful in the preparation of samples for instrumental analysis. The extended discussions in Part II for each of the elements no doubt will prove to be the most enduring material in this book. For each element (or small group of elements), there is a detailed discussion of occurrence, importance, general considerations of the chemical behavior that are important in its analysis, dissolution procedures for mineral forms of the element, methods of separation, and methods of determination.

This book is expected to remain the key reference work for highly accurate classical analytical methods, and although these methods are less commonly practiced today, analytical chemists will continue to appreciate the theory, chemical knowledge, and artistry inherent to their application. *Applied Inorganic Analysis* will continue to be a clear window on the past, providing

detailed discussions and procedures for those needing to perform classical analytical determinations. Those fortunate enough to own a copy have a masterpiece and a treasure.

Prepared by Charles M. Beck II.

Bibliography

- [1] W. F. Hillebrand and G. E. F. Lundell, *Applied Inorganic Analysis*, John Wiley & Sons, New York (1929).
- [2] W. F. Hillebrand, G. E. F. Lundell, H. A. Bright, and J. I. Hoffman, *Applied Inorganic Analysis, Second Edition*, John Wiley & Sons, New York (1953).
- [3] W. F. Hillebrand, A Plea for Greater Completeness in Chemical Rock Analysis, *J. Am. Chem. Soc.* **16**, 90-93 (1894).
- [4] W. F. Hillebrand, Some Principles and Methods of Analysis Applied to Silicate Rocks, in *Analyses of Rocks with a Chapter on Analytical Methods, Laboratory of the United States Geological Survey, 1880-1896*, Frank Wigglesworth Clarke and W. F. Hillebrand, *U.S. Geological Survey Bulletin*, No. 148 (1897) pp. 15-64.
- [5] W. F. Hillebrand, *Some Principles and Methods of Rock Analysis, U. S. Geological Survey Bulletin*, No. 176 (1900).
- [6] W. F. Hillebrand, *The Analysis of Silicate and Carbonate Rocks, U. S. Geological Survey Bulletin*, No. 305 (1907).
- [7] W. F. Hillebrand, *The Analysis of Silicate and Carbonate Rocks: A Revision of Bulletin 305, U.S. Geological Survey Bulletin 422*, (1910); slightly revised when reprinted in 1916.
- [8] W. F. Hillebrand, *The Analysis of Silicate and Carbonate Rocks: A Revised and Enlarged Edition of Bulletin 422, U.S. Geological Survey Bulletin 700* (1919).
- [9] G. E. F. Lundell and James Irvin Hoffman, *Outlines of Methods of Chemical Analysis*, John Wiley & Sons, New York (1938).
- [10] M. Gilbert Burford, review of *Applied Inorganic Analysis, Second Edition*, by W. F. Hillebrand, G. E. F. Lundell, H. A. Bright, J. I. Hoffman, *Anal. Chem.* **25**, 1279-1280 (1953).
- [11] L. S. Theobald, review of *Applied Inorganic Analysis, Second Edition*, by W. F. Hillebrand, G. E. F. Lundell, H. A. Bright, J. I. Hoffman, *Analyst (Cambridge, UK)* **79**, 113-115 (1954).

The Diamond Anvil Pressure Cell

Two intimately related scientific and technological achievements occurred in the field of high pressure research at the NBS laboratory during the second-half of the 20th century: the invention of the diamond anvil high pressure cell [1] in 1958 and the development of the optical ruby fluorescence method of pressure measurement [2] in 1972. These two developments together stimulated the profound advances in high pressure research that evolved in the latter part of the 20th century.

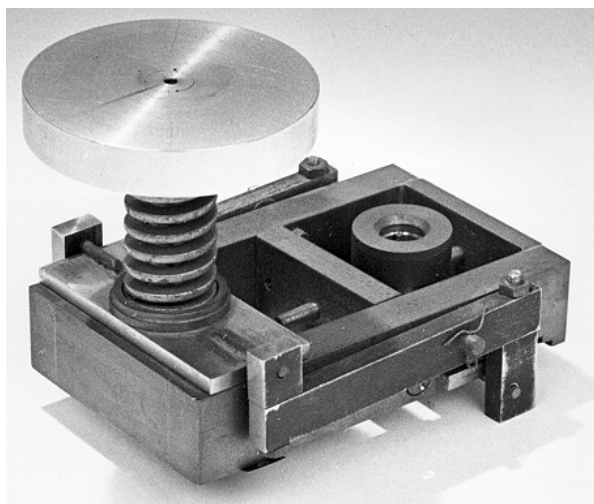

Fig. 1. The original DAC, on display in the NIST Museum.

The invention of the diamond anvil high pressure cell (DAC) took place in the Constitution and Microstructure Section (then headed by H. F. McMurdie) of the Mineral Products Division (Irl C. Schoonover, Chief) in the late 1950s at the NBS laboratories in Washington. It was the product of the joint effort of four individuals, Charles E. Weir, Alvin Van Valkenburg, Ellis R. Lippincott, and E. N. Bunting. Each of these scientists contributed a separate and distinct expertise which, when combined with the others, provided the impetus necessary for the development of the new pressure cell. Weir had developed an intense interest and appreciation for the effect of high pressure on the properties and structure of materials through his construction of a device to study porosity of leather and the compressibility of teflon and other materials. For this work, he received the Department of

Commerce Silver Medal in 1954. Van Valkenburg had designed a high-temperature furnace for the synthesis and growth of mica, but he also utilized a tetrahedral anvil press for the synthesis of diamonds. Bunting studied phase equilibria and electrical properties of ceramic oxide systems. Lippincott, a guest scientist from the University of Maryland, collaborated with these individuals on measurement of infrared spectra of inorganic materials. He had a special interest in short-range interatomic forces and the perturbing effects of neighboring atoms on each other—effects that would be amplified by the change in lattice spacing produced by high pressures. The presence of all four of these individuals in the same laboratory space enabled a fruitful exchange of ideas that eventually led to the concept of a miniature high pressure device with an optical access permitting the measurement of infrared absorption spectra.

The DAC conceived in this setting [1] was a lever-arm type device with a 180° optical transmission path which permitted, for the first time, the infrared spectroscopic measurements on powders squeezed between two opposed diamond anvils. Among the first materials studied were NaNO_3 , KNO_3 , AgNO_3 , ferrocene, ice, and CaCO_3 . These initial studies demonstrated that pressure-dependent shifts in frequency and changes in intensity of infrared absorption bands could be measured, and also led to the observation of large changes in spectra as a result of pressure-induced phase transitions. This NBS instrument was the prototype for all subsequent opposed-anvil diamond cells with 180° optical transmission.

The first cell was handmade by Charles E. Weir, who fabricated it utilizing only a lathe, drill press, hack saw, soldering gun, threading tools, files, and a high speed grinding wheel to polish down the culets of the diamonds to form anvil faces. The gem diamonds were obtained by Alvin Van Valkenburg from the General Services Administration, which, at that time, served as the custodian for contraband diamonds confiscated from smugglers by government agents. In those days, such diamonds were free for use by other government agencies, provided that their purpose could be justified. It is of interest to note that without the availability of these gratis gem diamonds, it is probable that the DAC would not have been developed as rapidly as it was, because during the early stages of its development many diamond anvils were destroyed in the testing process.



Fig. 2. Charles Weir, ca. 1960.

To replace them would have been prohibitively expensive. The original instrument, small enough to fit in the palm of one's hand, can be seen today on display in the NIST Museum.

By 1971, the DAC had undergone several stages of refinement and had been adapted to other measurement techniques by NBS and various other laboratories in the United States. Still, it was not fully appreciated as a scientific instrument because there remained a very significant problem. There was no convenient, precise method for determining the pressure being exerted on the sample in the diamond anvil cell. Pressures had either to be calculated (force per unit area) or measured from compression data (utilizing an equation of state, e.g., of sodium chloride) obtained by an x-ray powder diffraction method. However, the former procedure was very inaccurate, and the latter, although more accurate, was tedious and time consuming, often requiring as much as fifteen hours to make one pressure determination. Consequently, in 1970, acceptance of the DAC as a tool in high pressure research was somewhat limited. It was used primarily in laboratories engaged in research of geological interest where very high pressures simulating the earth's interior were desired, while the accuracy in the value of the pressure was not yet of primary importance.



Fig. 3. A. Van Valkenburg, 1962.

In 1971, this situation changed dramatically. The high pressure group at NBS was under the ever-present prodding of management to develop a better method for measuring pressures in the DAC. The problem was discussed one day in the NBS cafeteria among John (Jack) B. Wachtman, Jr., Chief of the Inorganic Materials Division, Stanley Block, Chief of the Crystallography Section, and Dean Barnett, a guest scientist at NBS on sabbatical leave from Brigham Young University. While they were having lunch together, the table conversation turned to possible techniques for measuring pressure. Wachtman suggested various methods, all of which had been considered already and found to be unsuitable. Finally, Wachtman asked the pivotal question, "Have you considered fluorescence spectroscopy?" As it happened, they had not, but replied that they would look into it. Encouraged by this meeting, Stanley Block, Dean Barnett, Gasper Piermarini, and Richard Forman began to study the pressure-dependence of several fluorescing materials. Some of these materials happened to be on the shelves in Forman's spectroscopy laboratory, while others were obtained from H. S. Parker and W. S. Brower of the Solid State Chemistry Section. Those materials included ruby (Al_2O_3), YAIO_3 , YAG, MgO , and a few others. While several materials had a readily observable pressure dependence, ruby exhibited

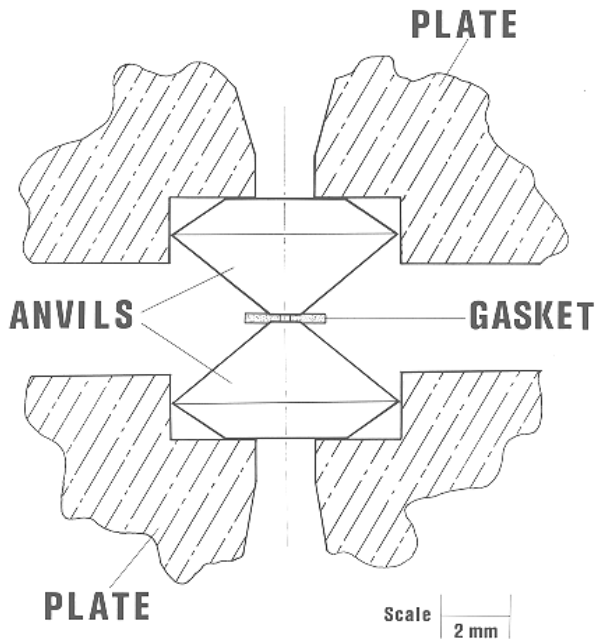

Fig. 4. A schematic diagram of the opposed diamond anvil assembly to illustrate the 180° optical transmission characteristics and the concept of Bridgman opposed anvils. A thin metal gasket containing a 250 μm diameter hole for encapsulating a sample (liquid or solid or both) is squeezed between the two anvils.

by far the most promising results. Ruby's main fluorescence lines (the R-line doublet lines) were intense and sharp, and the lines shifted toward the red end of the spectrum with increasing pressure. Significantly, pressure could be detected *in situ* using only a very small amount of ruby crystal (comprising only 1 % of the available volume) as the internal pressure sensor. Further, because ruby is chemically inert, it could be present in the sample chamber to detect pressure without interfering with any other experimental specimen in the chamber.

Recognizing the significance of these observations, it was of paramount importance to calibrate the R-line shift against reliable pressure values. This calibration was accomplished at NBS [3] using an x-ray powder diffraction method to measure the compression of NaCl and relating this to the measured shift in the wavelength of the ruby R₁-line. The corresponding pressure was calculated from the compression data utilizing an established equation of state for NaCl. The R₁-line shift was found to be linear with pressure (2.740 ± 0.016 kbar Å⁻¹ up to about 19.5 GPa. In subsequent work [4], the linearity was confirmed to about 29 GPa. The success of this calibration quickly established the ruby scale as a secondary pressure standard, and it became the *de facto* standard for measuring pressures in a DAC.

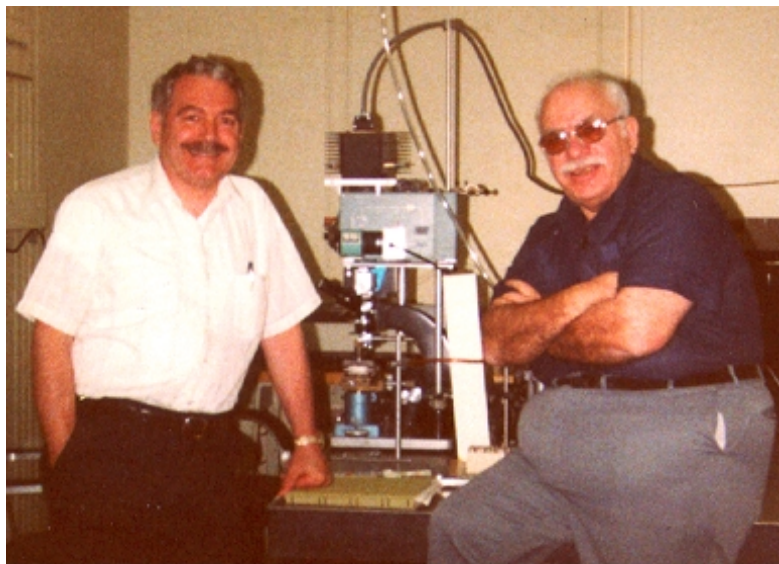

Fig. 5. Gaspar Piermarini and Stanley Block by the ruby fluorescence apparatus used with the DAC, ca. 1984.

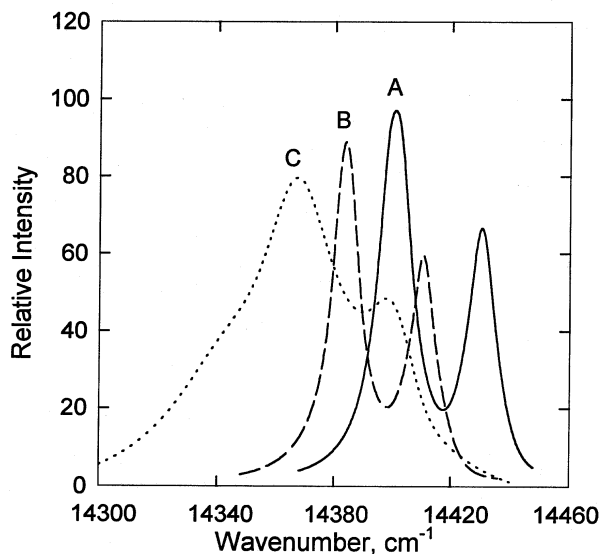

Fig. 6. The R-line luminescence spectrum of ruby in the DAC: curve A, ruby at ambient atmospheric pressure; curve B, ruby in a mixture of ices VI and VII at about 2.2 GPa; curve C, ruby in a nonhydrostatic mixture of CCl_4 III and IV at about 4 GPa.

In the years following the introduction of the DAC and the ruby pressure standard, numerous breakthroughs in high pressure research and technology were achieved at the NIST/NBS laboratory. Milestones or “firsts” were achieved in several areas, including the generation of ultrahigh pressures through improvements in the design of the original NBS DAC [4]; the development of a camera for obtaining x-ray powder diffraction data at high pressure [5]; the measurement of hydrostatic limits in pressure-transmitting media utilizing the ruby method [6]; the introduction of a metal gasket to encapsulate liquids and other materials under pressure between the diamond anvils [7]; the development of the methodology for determining crystal structures at high pressure in the DAC from single crystal x-ray diffraction intensity data (first application: growth and structure of a single crystal of ice VI) [8]; the application of the DAC to Raman spectroscopy [9]; and the measurement of the viscosity of liquids at ultrahigh pressures in the DAC by the classical Stokes method [10].

In 1974, Block and Piermarini were awarded the Department of Commerce Gold Medal for their work on the design, construction, and application of the high pressure system, including the diagonal pressure cell, the ruby fluorescent method of pressure measurement, and associated characterization techniques. These achievements ignited and fueled an explosion of activity in high pressure research by laboratories throughout the world, a profuse activity that continues unabated today.

Prepared by Gaspar Piermarini and Stanley Block.

Bibliography

- [1] C. E. Weir, E. R. Lippincott, A. Van Valkenburg, and E. N. Bunting, Infrared Studies in the 1- to 15-Micron Region to 30,000 Atmospheres, *J. Res. Natl. Bur. Stand.* **63A**, 55-62 (1959).
- [2] R. A. Forman, G. J. Piermarini, J. D. Barnett, and S. Block, Pressure Measurement Made by the Utilization of Ruby Sharp-Line Luminescence, *Science* **176**, 284-285 (1972).
- [3] G. J. Piermarini, S. Block, J. D. Barnett, and R. A. Forman, Calibration of the Pressure Dependence of the R_1 Ruby Fluorescence Line to 195 kbar, *J. Appl. Phys.* **46**, 2774-2780 (1975).
- [4] G. J. Piermarini and S. Block, Ultrahigh Pressure Diamond-Anvil Cell and Several Semiconductor Phase Transition Pressures in Relation to the Fixed Point Pressure Scale, *Rev. Sci. Instrum.* **46**, 973-979 (1975).
- [5] G. J. Piermarini and C. E. Weir, A Diamond Cell for X-ray Diffraction Studies at High Pressures, *J. Res. Natl. Bur. Stand.* **66A**, 325-331 (1962).
- [6] G. J. Piermarini, S. Block and J. D. Barnett, Hydrostatic Limits in Liquids and Solids to 100 kbar, *J. Appl. Phys.* **44**, 5377-5382 (1973).
- [7] Alvin Van Valkenburg, Visual Observations of High Pressure Transitions, *Rev. Sci. Instrum.* **33**, 1462 (1962).
- [8] S. Block, C. E. Weir, and G. J. Piermarini, High-Pressure Single-Crystal Studies of Ice VI, *Science* **148**, 947-948 (1965).
- [9] B. A. Weinstein and G. J. Piermarini, Raman Scattering and Phonon Dispersion in Si and GaP at Very High Pressure, *Phys. Rev. B* **12**, 1172-1186 (1975).
- [10] G. J. Piermarini, R. A. Forman and S. Block, Viscosity Measurements in the Diamond Anvil Pressure Cell, *Rev. Sci. Instrum.* **49**, 1061-1066 (1978).

Polymer Crystallization With Folded Chains

The Hoffman-Lauritzen theory of the formation of polymer crystals with folded chains, set forth four decades ago [1,2,3], owes its origin to the discovery in 1957 [4,5,6] that characteristically thin single crystals of polyethylene can be grown from dilute solutions. These crystals are thin platelets or lamellae, typically about 10 nm thick. As first proposed by Keller of the University of Bristol (UK) in his seminal paper [5], the long polymer chains are more or less regularly folded between the upper and lower lamella surfaces with the chain stems between successive folds oriented preferentially normal to the plane of the lamellae. Following very shortly after this discovery was the realization that lamellar crystals of polymers other than polyethylene also exhibited chain folding. More than that, chain folding was an essential feature of the crystallization of polymers from the molten state. In the latter case, polymers were found to undergo spherulitic crystallization, but the spherulites were composed of radiating structural units that were found to be lamellar and bore a kinship to solution grown crystals. In short, following the events of 1957, it was evident that a theory was needed to explain the then startling occurrence of chain folding and its general effects on polymer crystallization.

In 1961 and 1962 [1,2] Hoffman and Lauritzen presented their theory for the formation of chain-folded crystals based on surface nucleation concepts. Hoffman had visited Keller in Bristol earlier (in 1959) and had discussed the subject with him. Returning from the UK by air (traveling *via* the Azores because of a storm in the North Atlantic), Hoffman began to develop certain aspects of the theory. (The authors later joked that this was likely the only theory germinated between the Azores and New York that year). In their two papers, Hoffman and Lauritzen established the foundation of the kinetic theory of polymer crystallization from solution [1] and from the melt [2], paying particular attention to the energetics of the formation of chain-folded nuclei. Definite predictions were given under certain assumptions concerning the experimentally observed variation in lamellar thickness with crystallization temperature, the metastability and the melting point of lamellae, and the temperature dependence of the kinetics of crystallization rate. As the theory was extended, it began to receive attention and experimental support at NBS and elsewhere. In 1971, Hoffman and Lauritzen were awarded the High Polymer Physics Prize of the

American Physical Society. The citation read in part “for their Kinetic Theory of Polymer Crystallization.”

The theory was presented in a book chapter [3] in which Hoffman and Lauritzen benefitted substantially from the participation of G. T. Davis. The chapter was written at the behest of N. B. Hannay, who was then vice president of research at Bell Telephone Laboratories, where a number of scientists were working in the field of polymer physics and polymer crystallization in particular. In this chapter, the treatment of chain-folded crystallization was further extended and organized, and the extended work was applied to various polymers covering such topics as spherulite growth rate, the crystallization temperature dependence of the lamellar thickness, as well as the thermodynamic properties of chain-folded crystals. The chapter is especially notable in that it has been used extensively for teaching purposes.

From time to time since the original papers, other NBS personnel have been involved in the ‘chain-folding’ venture. Noteworthy contributions, mostly but not entirely experimental, were made by J. J. Weeks, G. S. Ross, L. Frolen, F. Gornick, and F. Khoury, and significant theoretical developments were made by E. A. Di Marzio, C. M. Guttman, E. Passaglia, and I. C. Sanchez. Further, from the broad perspective of the NBS/NIST history, it may be noted that research on polymer crystallization at NBS preceded by many years the discovery of chain folding. The long tradition of research on crystallizable polymers is exemplified by the pioneering works of L. A. Wood and N. Bekkedahl in the later 1930s and 1940s [7] and L. Mandelkern in the 1950s [8].

John Hoffman received his B.S. degree in chemistry in 1942 from Franklin Marshall College and his Ph.D. in physical chemistry in 1949 from Princeton University. He participated in the Manhattan Project (1944-1946, while in U. S. Army) and subsequently (1949-1954) was in the R&D branch of General Electric. In 1954, Hoffman joined NBS as a Research Chemist, becoming Chief of the Dielectrics Section in 1957 and Chief of the Polymers Division in 1964. From there, he advanced to Director of the Institute for Materials Research (1967-1978) and then Director of the National Measurement Laboratory (1978-82). Hoffman retired from NBS in 1982, but continued his career as Professor at the University of Maryland (1982-1985), Director and CEO of the Michigan Molecular Institute (1985-1990), and as Research Professor in the Department of Materials



Fig. 1. John Hoffman, 1961.

Science and Engineering at Johns Hopkins University (1990-present). Throughout his career, he has received numerous awards, including the Soldiers Medal (military decoration, 1946), the U. S. Department of Commerce Gold Medal (1965), the Samuel Wesley Stratton Award of NBS (1967), and election to the National Academy of Engineering (1980).

John Lauritzen, Jr. received an A.B. in mathematics in 1949 (University of Miami, Ohio) and a Ph.D. in physics in 1955 (California Institute of Technology). He came to NBS as a physicist in the Electricity Division in 1956, before joining the Polymers Division in 1964. In 1968, he was appointed Senior Scientist, NBS Institute for Materials Research, a post he held until his death (October 11, 1976). His research included the theory of polymer crystallization, dielectric relaxation in molecular compounds, statistical mechanics, and multi-component rate theory. His distinguished career was acknowledged in receiving the Samuel Wesley Stratton Award with E. Di Marzio and E. Passaglia in 1971.

G. T. (Tom) Davis received his B. Chem. Eng. in 1956 from Cornell University and his Ph.D. in physical chemistry in 1963 from Princeton University. In his early work, he was a research chemist in the Chemical Research Division, Esso Research and Engineering Co. (1956-1960) and an Assistant Professor of Chemistry at the University of Virginia (1963-1964). In 1964-1966, he was awarded an NRC-NSF Post Doctoral Fellowship at NBS and, two years later, he was appointed a research chemist in the Polymers Division of NBS.

He advanced to the position of Group Leader in the Polymers Division in 1984 and served in that position until 1998, before retiring in 1999. For his meritorious work in polymer science and engineering, he was awarded the U. S. Department of Commerce Bronze Medal in 1980.



Fig. 2. John Lauritzen, 1961.

Prepared by Freddy Khoury in consultation with John Hoffman and Tom Davis.

Bibliography

- [1] John I. Lauritzen, Jr. and John D. Hoffman, Theory of Formation of Polymer Crystals with Folded Chains in Dilute Solution, *J. Res. Natl. Bur. Stand.* **64A**, 73-102 (1960).
- [2] John D. Hoffman and John I. Lauritzen, Jr., Crystallization of Bulk Polymers With Chain Folding: Theory of Growth of Lamellar Spherulites, *J. Res. Natl. Bur. Stand.* **65A**, 297-336 (1961).
- [3] John D. Hoffman, G. Thomas Davis, and John I. Lauritzen, Jr., The Rate of Crystallization of Linear Polymers With Chain Folding, Chapter 7 in *Treatise on Solid State Chemistry: Vol. 3: Crystalline and Noncrystalline Solids*, N. B. Hannay (ed.), Plenum Press, New York (1976) pp. 497-614.
- [4] P. H. Till, Jr., The Growth of Single Crystals of Linear Polyethylene, *J. Polym. Sci.* **24**, 301-306 (1957).
- [5] A. Keller, A Note on Single Crystals in Polymers: Evidence for a Folded Chain Configuration, *Philos. Mag., Ser. 8*, **2**, 1171-1175 (1957).
- [6] E. W. Fischer, Stufen- und spiralförmiges Kristallwachstum bei Hochpolymeren, *Z. Naturforsch.* **12a**, 753-754 (1957).
- [7] Lawrence A. Wood and Norman Bekkedahl, Crystallization of Unvulcanized Rubber at Different Temperatures, *J. Res. Natl. Bur. Stand.* **36**, 489-510 (1946).
- [8] L. Mandelkern, Crystallization Kinetics in Polymeric Systems, in *Growth and Perfection of Crystals* (Proceedings of an International Conference on Crystal Growth held in Cooperstown, New York, August 1958), R. H. Doremus, B. W. Roberts, and D. Turnbull (eds.), John Wiley and Sons, New York (1958) pp. 467-595.

Cryogenic Engineering

Cryogenic Engineering by Russell B. Scott [1] was written between 1955 and 1959 as a text book, reference book, and data book. It covered liquefaction and separation of gases; thermometry; instrumentation; thermal insulation; storage, transport, and transfer of liquids; and properties of fluids and solids. It contains the best detailed description of the liquefier project that was conducted in the early 1950s at the NBS Boulder Laboratories. The book has been reprinted several times, most recently in 1995, and more than 6000 copies have been sold.

The NBS cryogenics program started in 1904 when Congress appropriated funds to purchase the two-liter-per-hour hydrogen liquefier exhibited at the St. Louis World's Fair by the British Oxygen Company. It was rarely used until 1925, when F. G. Brickwedde, and later Russell Scott, started producing liquid hydrogen for research and as a coolant to liquefy helium. In the early 1930s, Harold C. Urey of Columbia University set out to prove experimentally the existence of an isotope of hydrogen which we now call deuterium. As described elsewhere in this volume, he asked Brickwedde to liquefy hydrogen and, by distillation, to concentrate isotopes for spectroscopic analysis. Urey found deuterium present in the sample [2] and was awarded the Nobel Prize. In 1934, Scott, Brickwedde, Urey, and Wahl [3] published the hydrogen ortho/para uncatalyzed conversion rates, and in 1948, Woolly, Scott, and Brickwedde [4] published a compilation and critical evaluation of the thermal properties of the isotopes of hydrogen.

In the 1940s, the emphasis in the field of cryogenics changed dramatically from research to engineering, which stimulated great improvements in system performance. Some of the engineering applications that evolved over the next decades included storage and shipment of gases such as oxygen, nitrogen, hydrogen, helium, and natural gas in liquid form; production of oxygen for making steel; rocket and aircraft fuels; energy transport and storage; electronics; and facilities for high-energy physics. NBS was one of the few U.S. laboratories with equipment, personnel, and experience to meet the national need for information and data.

During World War II, Brickwedde and Scott participated in the Manhattan Project [5], measuring the thermodynamic properties of materials used in the atomic bomb, including uranium. After the war,

Brickwedde became a consultant on cryogenics at the Los Alamos Scientific Laboratory (LASL), working with Edward Hammel and members of the LASL cryogenic group. NBS Director Edward U. Condon, who had played a part in the work at Los Alamos during the war, wanted to expand NBS research in atomic and nuclear physics and encouraged Brickwedde to facilitate collaboration with LASL.

When President Truman authorized the design and testing of a hydrogen bomb in 1950 to counter a threat from the Soviet Union, the U.S. Atomic Energy Commission, through LASL Director Norris Bradbury, asked NBS to participate. He requested that NBS build a large hydrogen-liquefaction plant; set up and run a hydrogen/deuterium electrolysis plant; test prototype dewars for Los Alamos; assist MIT and Arthur D. Little Company (ADL) in the design and construction of dewars and refrigerators; test hydrogen transport dewars; and train personnel in large-scale hydrogen production and hydrogen handling.

Russell Scott, assisted by William Gifford, Victor Johnson, and Dudley Chelton, designed and built the critical components (heat exchangers and gas purifiers) for four 320 L/h hydrogen/deuterium liquefiers in the NBS shops in Washington. The NBS staff quickly expanded to include Bascom Birmingham, Richard Kropschot, Douglas Mann, Robert Powell, Robert Jacobs, Leon Wagner, and Peter Vander Arend. In 1950, the City of Boulder gave NBS a 28-acre site for relocation of the Central Radio Propagation Laboratory and, later, other NBS units from Washington. Under NBS direction, Stearns Roger Engineering erected two of the liquefiers in Boulder. The third liquefier was erected by Holmes and Narver on the Eniwetok Atoll, site of an upcoming nuclear test, under the direction of Herrick Johnston of Ohio State University, with assistance from George Freeman and Leon Wagner of NBS. The fourth liquefier was used for spare parts.

In order to obtain deuterium, two water electrolyzers were installed in Boulder, heavy water was imported from Canada, and work was begun to produce deuterium gas needed for the upcoming nuclear test. The deuterium was compressed into high-pressure tanks and shipped to the atomic proving station on Eniwetok in the Marshall Islands where it was condensed using the NBS liquefier.

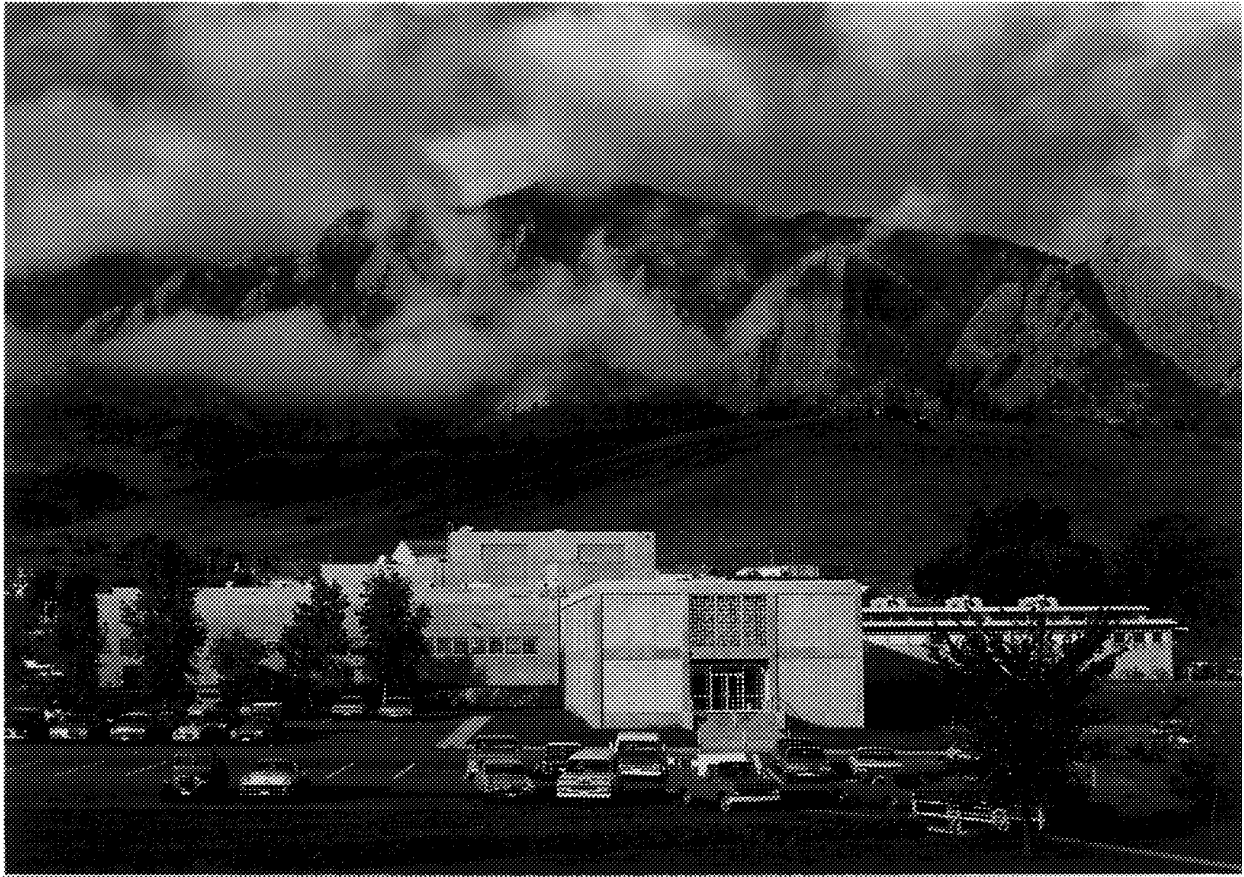

Fig. 1. The Cryogenics Building at the NBS Boulder Laboratories was the first ever designed specifically for cryogenic-engineering research. Photograph from NBS Archives, taken in 1968.

The thermonuclear device was designed at Los Alamos [6]. Liquid hydrogen used to test the components was safely transported from where it was produced in Boulder to Los Alamos in dewars designed and built by the Cambridge Corporation. Because of program priorities, the Cambridge Corporation and LASL took on the primary responsibility for the design and testing of the dewars. In March and April 1952, Herrick Johnston and his staff visited Boulder to participate in liquefier operation as part of the preparation for assembling and operating the liquefier on Eniwetok. On November 1, 1952, the Eniwetok Atoll was evacuated of all personnel, and the “ivy MIKE” shot was detonated. It was the first hydrogen thermonuclear device and was regarded as extremely successful, yielding 10.4 megatons of TNT equivalent and providing scientific data for future tests and development of weapons. The liquefier described in Scott’s book played a critical role in the success of this test.

In 1953, the NBS staff (Brickwedde, Scott, Baird, Birmingham, Chelton, Freeman, Gifford, Goddard, Johnson, Kropschot, Powell, and Vander Arend) were

awarded the Department of Commerce Gold Medal for “The design, construction and operation of large and unique hydrogen and nitrogen liquefiers.”

As the need for cryogenics in nuclear testing diminished, the NBS cryogenics facilities, led by Russell Scott, turned attention to a growing national need for scientists and engineers to be trained in cryogenics, as well as to the measurement and collection of very low temperature data. Scott organized the Boulder staff into discipline-oriented groups to provide the data necessary for cryogenic design. These groups included Thermodynamic Properties of Cryogenic Fluids; Mechanical and Thermal Properties of Solids; Instrumentation (thermometry, liquid level, pressure); Systems (liquefaction and refrigeration, fluid flow, dewar design, distillation); Data Center (compilation, critical evaluation and dissemination of data); and Production of Cryogenic Fluids (hydrogen, helium, nitrogen).

Scott was committed to on-going training, and in 1954 he initiated the first Cryogenic Engineering Conference (CEC) in Boulder, which attracted more than 400 participants. The technical papers were

published in the first volume of *Advances in Cryogenic Engineering (ACE)*. Since then there have been a total of 40 CEC conferences with commensurate *ACE* publications involving an estimated 25,000 participants.

An entire generation of engineers and scientists has used Scott's *Cryogenic Engineering*, which not only outlines fundamentals, but also includes detailed design principles and techniques. It was the first of its kind and is still considered an important reference today. The book begins with a description of how fluids are liquefied and gas mixtures are separated. The examples illustrate the basics of design and operation for all types of cryogenic equipment. Thermometry is fundamental to all of cryogenics. The book includes a discussion of temperature scales and temperature measurements, as well as guidance on how to avoid common errors when making these measurements. It continues with a discussion of representative technology including heat exchangers, valves, transfer lines, expansion engines, and insulation technology—since once gases are liquefied, they are ready for transfer, storage, and transport. Both tables and graphs are used to illustrate typical thermal insulations. The small heats of vaporization coupled with relatively large temperature differences warrant sophisticated insulations. These insulations almost always require double-walled high vacuum designs. The vacuum space is often filled with

low-density powder or multilayers of radiation-reflecting material. The thermodynamic properties of cryogenic fluids—helium, hydrogen, neon, nitrogen, and oxygen—are presented graphically. The book also includes data on the thermal and mechanical properties of some of the more widely used structural materials. Each chapter cites references to handbooks and review articles that are fundamental to cryogenic research. In the preface, Scott acknowledged the assistance of NBS staff members who contributed to the preparation of the book and who helped establish NBS as a world-class research facility and a national resource.

In 1960, Scott was invited by the director of the UCLA Engineering Extension Division to teach a two-week short course using *Cryogenic Engineering* as the text. Assisted by R. H. Kropschot, Scott presented his first course in December 1960. The UCLA course was taught annually for more than 35 years by a variety of instructors from the NBS Boulder Laboratories. Other courses followed in Boulder, at various NASA facilities, universities, National Laboratories, and other institutions. Over the years, an estimated 5,000 students have taken these NBS-initiated short courses. In 1967, Scott received the Department of Commerce Gold Medal for Exceptional Service for “Exceptional Leadership and Meritorious Authorship in the Development of *Cryogenic Engineering*.”



Fig. 2. Russell B. Scott (second from right) receives gift at his retirement in 1965. The presentation is being made by (from left to right) F. G. Brickwedde (Pennsylvania State University), former Director Edward U. Condon (NBS), Division Director B. W. Birmingham (NBS), Associate Director Edward Hammel (LASL), and Director Allen Astin (NBS). Photograph from NBS Archives.

Scott's legacy is more than a book and the organization that he helped to build at NBS. Members of his staff participated in all the major U.S. cryogenic engineering programs for more than 25 years. Some examples of his legacy may be mentioned. In his Nobel acceptance speech, Luis Alvarez (University of California, Berkeley) acknowledged the work of Chelton, Mann, and Birmingham for design contributions to the Lawrence Berkeley Laboratory hydrogen bubble chamber. NBS programs funded by NASA supported Centaur, the first hydrogen/oxygen space vehicle; storage of hydrogen and oxygen for fuel cells and breathing oxygen; hydrogen/oxygen safety; fluid and solid properties; instrumentation; and fluid flow. Measurements, compilation, and critical evaluation of the thermodynamic properties of fluids by NBS scientists (Corruccini, Goodwin, McCarty, Strobridge, Roder, Diller, Weber, and Younglove) have fulfilled governmental and industrial requirements for engineering design. They assisted in the design and construction of the NASA hydrogen liquefiers (the Bear Plants—Baby, Mama, and Papa); design of high energy physics accelerators and detectors; and the formulation of LNG safety procedures. A data book describing safety regulations and thermodynamic properties [7] was developed for the liquefied-natural-gas (LNG) industry. And finally, one of Scott's legacies most often cited is that of technology transfer, which has had a wide impact as former NBS employees move into new positions in industry and academia.

Russell B. Scott was born in Ludlow, Kentucky, on April 17, 1902. He received his B.S. (1926) and M.S. (1928) in physics from the University of Kentucky and joined NBS immediately afterward. He was Director of the Boulder Cryogenics Laboratory from 1952 to 1962 and Director of NBS Boulder Laboratories from 1962 to 1965. He died September 24, 1967 in Boulder.

Prepared by Richard H. Kropschot.

Bibliography

- [1] Russell B. Scott, *Cryogenic Engineering*, D. Van Nostrand Co., Princeton, New Jersey (1959); reprinted Oct. 1959, Aug. 1960, May 1962, and in 1995.
- [2] H. C. Urey, F. G. Brickwedde, and G. M. Murphy, A Hydrogen Isotope of Mass 2, *Phys. Rev.* **39**, 164-165 (1932).
- [3] R. B. Scott, F. G. Brickwedde, Harold C. Urey, and M. H. Wahl, The Vapor Pressures and Derived Thermal Properties of Hydrogen and Deuterium, *J. Chem. Phys.* **2**, 454-464 (1934).
- [4] Harold W. Woolley, Russell B. Scott, and F. G. Brickwedde, Compilation of Thermal Properties of Hydrogen in Its Various Isotopic and Ortho-Para Modifications, *J. Res. Natl. Bur. Stand.* **41**, 379-475 (1948).
- [5] Richard Rhodes, *The Making of the Atomic Bomb*, Simon and Schuster, New York (1986).
- [6] Richard Rhodes, *Dark Sun: The Making of the Hydrogen Bomb*, Simon and Schuster, New York (1995).
- [7] Douglas B. Mann, *LNG Materials and Fluids: A User's Manual of Property Data in Graphic Format*, NBS Cryogenics Division, National Bureau of Standards, Boulder, Colorado (1977).

Reversal of the Parity Conservation Law in Nuclear Physics

In late 1956, experiments at the National Bureau of Standards demonstrated that the quantum mechanical law of conservation of parity does not hold in the beta decay of ^{60}Co nuclei. This result, reported in the paper *An experimental test of parity conservation in beta decay* [1], together with ensuing experiments on parity conservation in μ -meson decay at Columbia University, shattered a fundamental concept of nuclear physics that had been universally accepted for the previous 30 years. It thus cleared the way for a reconsideration of physical theories, especially those relating to symmetry, and led to new, far-reaching discoveries regarding the nature of matter and the universe. In particular, removal of the restrictions imposed by parity conservation first resolved a serious conflict in the theory of subatomic particles, known at the time as the tau-theta puzzle, and later led to a fuller understanding of the strong, electromagnetic, and weak interactions. The better understanding of their characteristics has led to a more unified theory of the fundamental forces.

The beta-decay experiments were carried out by C. S. Wu of Columbia University in collaboration with NBS staff members Ernest Ambler, Raymond W. Hayward, Dale D. Hoppes, and Ralph P. Hudson. The Bureau's low temperature laboratory was chosen for the experiments because of its millikelvin-region research capability [2] and the staff's experience in the spatial orientation of atomic nuclei [3], an essential feature of the beta-decay study.

Basically, parity conservation in quantum mechanics means that two physical systems, one of which is a mirror image of the other, must behave in identical fashion. In other words, parity conservation implies that Nature is symmetrical and makes no distinction between right- and left-handed rotations, or between opposite sides of a subatomic particle. Thus, for example, in beta decay there should be no preferential direction of emission with respect to the direction of the spin of the emitting nucleus, i.e., no (nuclear) spin—(electron) momentum correlation.

Since 1925, physicists had accepted the principle that parity is conserved in all types of interactions. During the 1950s, however, phenomena were found in high-energy physics that could not be explained by existing theories. The available accelerators produced a variety of subatomic particles. One such particle is the short-lived K meson emitted in the collision of a high-energy

proton with an atomic nucleus. The K meson seemed to arise in two distinct versions, one decaying into two π mesons, the other decaying into three pions, with the two versions being identical in all other characteristics. A mathematical analysis showed that the two-pion and the three-pion systems have opposite parity; hence, according to the prevalent theory, these two versions of the K meson had to be different particles.

Early in 1956, T. D. Lee of Columbia University and C. N. Yang of the Institute for Advanced Study, Princeton University, made a survey [4] of experimental information on the question of parity. They concluded that the evidence then existing neither supported nor refuted parity conservation in the "weak interactions" responsible for the emission of beta particles, K-meson decay, and such. They thus proposed that the K-meson itself may have definite parity, and the observed opposite parity of the two systems of decay products may be the manifestation of parity non-conservation in its decay. They suggested that parity may not be conserved in weak interactions, saw that there was no experimental evidence that proved that this was or was not true, and proposed a number of experiments that would provide the necessary evidence. One of the proposed experiments, which involved measuring the directional intensity of beta radiation from oriented ^{60}Co nuclei, seemed to them to be the best prospect for success in testing their hypothesis. Yang and Lee had turned to beta-spectroscopist and Columbia University friend and colleague Chien-Shiung Wu for advice on how to pursue their preferred suggestion. Wu, in turn, approached Henry Boorse of Columbia and his close associate Mark W. Zemansky of the City College of New York, who together ran a modest research program in cryophysics at Columbia. Although these scientists lacked the "parity-required" facilities, they were active members in the international low-temperature-physics community, well acquainted with the NBS program and the recent move thereto of Ernest Ambler, a graduate from the Oxford (UK) "cryonuclear physics" research program [5]. It was they who suggested that Wu make initial contact with Ambler and, in fairly short order, arrangements were made to carry out this experiment in the Bureau's low-temperature laboratory.

The envisaged experiment was far from routine and involved many unknowns at the outset. The source of the β -rays would have to be in intimate contact with the

cooling medium (paramagnetic crystal) and also on the surface, so that the beta particles could get out of the crystal. Could the contact and refrigeration be made adequate? Would back-scattering be, in consequence, a major drawback? How to count the β -rays? In situ? Remotely? And either way—exactly how? What of the external magnetic field necessary for polarizing the cobalt nuclei without heating up the refrigerating salt? What was the optimum activity of the β -source—large being best for detection sensitivity, small for minimizing local heating?

Polarization of the nuclei was achieved by cooling a paramagnetic crystal containing ^{60}Co to within 0.003 K and subjecting it to a magnetic field. At this temperature the effects of thermal agitation are so small that atomic nuclei can line up in a given direction within the crystal lattice when a magnetic field is applied. The magnetic polarity of the nucleus is determined by its direction of spin and, under the influence of a magnetic field, most of the ^{60}Co nuclei align themselves so that their spin axes are parallel to the field. If parity is conserved in beta decay, then the intensity of the beta emission should be the same in either direction along the axis of spin. This, of course, was the critical question in the ^{60}Co experiments. It was resolved by measuring the intensity of beta emission in both directions, i.e., along and against the field direction.

The ^{60}Co was located in a thin (50 μm) surface layer of a single crystal of cerous magnesium nitrate (CMN). The crystal was placed in an evacuated flask which, in turn, was immersed in liquid helium within a Dewar flask surrounded by liquid nitrogen. An inductance coil on the surface of the inner flask was used to measure the temperature of the crystal in terms of its magnetic susceptibility. CMN is extremely anisotropic: the trivalent sites in its plate-like natural form are almost non-magnetic along the (out-of-plane) c -axis, but are uniformly magnetic in the plane. Co ions, however, would go into divalent sites which are contrary magnetically, i.e., most easily magnetized *along* the crystallographic c -axis. Thus in magnetic anisotropy, CMN should be ideal for the experiment: major (magnetic cooling) field in the plane, small polarizing (solenoid) field perpendicular to the plane, with negligible temperature-raising effect. But might not that polarizing field exert a torque on the crystal of sufficient strength to break a typically fragile thermally-isolating mounting?

A major experimental problem was the location of a radiation counter within the evacuated flask for detection of beta particles. This problem was solved by placing a thin anthracene crystal inside the chamber to serve as a scintillation counter. The anthracene crystal was located about 2 cm above the ^{60}Co source. Scintillations caused by beta particles striking the

crystal were transmitted through a glass window and a 120 cm lucite rod acting as a light pipe to a photomultiplier at the top of the flask. The resulting pulses were counted on a 10-channel pulse-height analyzer. It proved possible to design the light pipe so as to hold the resultant contribution to the liquid-helium loss rate to a tolerable level.

In addition to the beta counter within the vacuum chamber, two sodium iodide gamma scintillation counters were used externally to measure the directional intensity of the more penetrating gamma radiation. In this way the investigators were able to determine the degree of polarization of the ^{60}Co nuclei. The two gamma counters were biased to accept only the pulses from the photopeaks in order to discriminate against pulses from Compton scattering.

Close to midway through the six-month work-up period, the team reached the conclusion that problems arising from outgassing within the crucial chambers of the apparatus would never be surmounted, and the entire assembly was re-designed from stainless steel to glass and a new version quickly constructed and assembled.

Cooling to the low temperature necessary for nuclear alignment was accomplished by the process of adiabatic demagnetization using a magnetic field of about 2.3 T (23 kilogauss). This process involved isothermal magnetization and subsequent isentropic demagnetization of the paramagnetic salt, CMN, which supported the ^{60}Co specimen. The heat produced by magnetization was removed by transfer through helium “exchange gas” and the boiling off of liquid helium in the surrounding dewar. The specimen was then thermally isolated by pumping out the exchange gas and upon demagnetization the temperature fell to about 0.003 K.

Next, a vertical solenoid was raised around the lower end of the outer dewar to provide a magnetic field for polarization of the ^{60}Co nuclei. After the beta emission had been measured for this condition, the direction of the magnetic field was reversed and the beta emission again measured for the nuclei now polarized in the opposite direction. It was found that the emission of beta particles is greater in the direction opposite to that of the nuclear spin. Thus, a spinning ^{60}Co nucleus has a beta emission distribution that is not the same as that of its mirror image. This result unequivocally demonstrated that parity is not conserved in the emission of beta particles by ^{60}Co .

Beyond the primary question resolved by this experiment, another matter of great interest was “how large was the effect” since, in principle, the asymmetry—if observed at all—could have turned out to be anywhere from zero to maximum (asymmetry parameter from 0 to 1); it was, in fact, *maximum*. Thus the general opinion (largely derisory!) about the likelihood of the

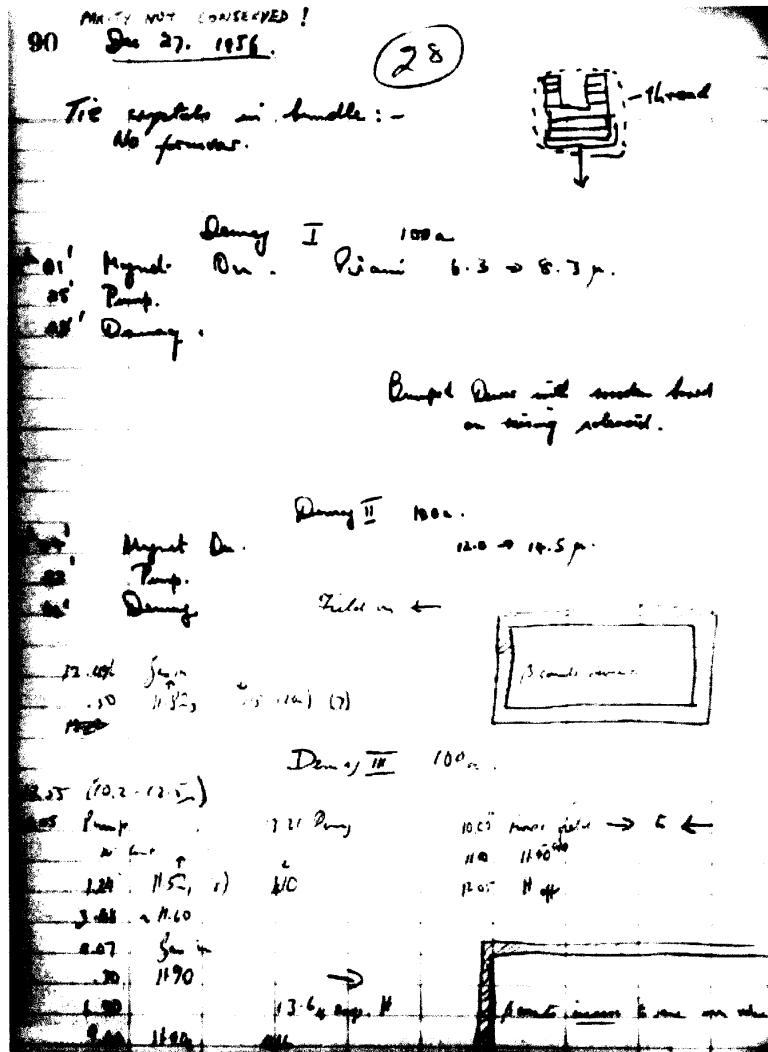

Fig. 1. The page of Ernest Ambler's notebook recording the first definitive evidence that parity is not conserved. The comment to that effect at the top left of the page was added by Ralph Hudson.

proposal of Lee and Yang bearing fruit changed overnight, and the nuclear physics community scrambled to try out other tests that would now be quite feasible. In fact, colleagues of C. S. Wu were able to design an experiment at the Columbia University cyclotron and demonstrate within a day or two the "parity effect" in a $\pi\text{-}\mu\text{-}e$ decay experiment [6], long before the NBS-Wu team could carry out all the "check experiments" they anticipated would now be demanded by the skeptics!

After those checks had been completed, a second experiment was performed [7] using ^{58}Co , which is a positron emitter. In this case the positrons were emitted preferentially in the opposite direction to that of the electrons, that is, β^+ particles are preferentially emitted along the direction of the nuclear spins. This provided

additional confirmation of the conjecture of Lee and Yang and supported the new theory that was being developed at the time to explain parity non-conservation.

While the general U.S. physics community reacted rapidly with great interest and excitement to these momentous events, culminating in extraordinary jam-packed sessions at the New York meeting of the American Physical Society in January 1957, other sentiments intruded upon the otherwise euphoric scene: Skepticism leveled at the original Lee-Yang proposal was replaced, in some minds, by disbelief in the results of these validating experiments, for parity conservation was an article of faith not to be discarded lightly. The NBS team's colleague from Washington's Carnegie Institution Department of Terrestrial Magnetism,

Georges M. Temmer, was on a laboratory odyssey in Western Europe at the time of the first news outbreak. At one point, Temmer found himself in the presence of *eminence grise* Wolfgang Pauli, who asked for the latest news from the United States. Temmer told him that parity was no longer to be assumed “conserved.” “That’s total nonsense” averred the great man. Temmer: “I assure you the experiment says it is not.” Pauli (curtly): “Then it must be repeated!” [8].

Not long after this, the world settled down to the realization that Lee and Yang had been right. Interestingly, though, a reluctance to believe that NBS staff had played a significant role (indeed, any role for some minds) in the crucial experiment began to spread in the less-informed parts of the U.S. scientific community, and elsewhere. Even as early as that European tour of Temmer’s, he encountered this. At a colloquium, also in Switzerland, and present when the proceedings were interrupted for an announcement of the “triumph at Columbia U.,” Temmer spoke from the floor to make the correction that the work had been carried out at the National Bureau of Standards; he was—more or less politely—“hooted down.” And despite his international standing—even especially in that particular community—he was pitied as being extraordinarily “mistaken.” Later on, and forever afterward, hardly a speaker or writer referred to the event in any other term than “the Wu experiment” and only C. N. Yang himself and Chief Cryogenic Notable Nicholas Kurti went out of their way to try to set the record straight.

The further developments of the theory, together with a large number of follow-up experiments, have led to the unification of the weak and electromagnetic interactions. A description of both the history and the physics is available in the Nobel lectures by Weinberg, Salam, and Glashow [9].

In 1957, NBS moved rapidly to include those of its staff in the “parity experiment team” in its Honors & Awards for that year, presenting them with the Commerce Department’s Award for Exceptional Service (the Gold Medal). In 1964 it added its own highest recognition, the Samuel Wesley Stratton Award. In 1962, the Franklin Institute of Philadelphia awarded its John Price Wetherill Medal to the full team.

C. S. Wu resumed her full-time preoccupation with β -decay research at Columbia University and the concomitant training of graduate students there. Over the years she received many honors, including the National Medal of Science (1975), the Wolf Prize in Physics (1978), and election to the Presidency of the American Physical Society (1975), the first woman to achieve that distinction. Wu died in New York in February 1997 at the age of 84 [10].

Ralph Hudson was appointed Chief of the Heat Division at NBS in 1961, and Ernest Ambler moved up to take his place as Chief of the Cryogenic Physics Section. For several years Ambler continued to carry out research, in collaborative efforts on oriented nuclei and superconductivity. He then went on to occupy a series of positions of increasing responsibility at NBS, culminating in Director of the agency—after several years as Acting Director—a post he held from 1978 to 1988 [11]. During this period, he received the President’s Award for Distinguished Federal Civilian Service. Prior to his retirement from NIST in 1989, at the age of 65, he was Acting Undersecretary for Technology in the Department of Commerce.

Hudson continued to do research, as administrative preoccupations would permit, on cryothermometry and low-temperature magnetism. A review article co-authored by him received NBS’s Condon Award in 1976 for distinguished authorship [12]. In the NBS reorganization of 1978, the Heat Division was abolished and Hudson became Deputy Director, under Karl G. Kessler, of the Center for Absolute Physical Quantities, with additional responsibility for managing the standards activity in Mass and Length. He resigned in 1980 and went to work at the International Bureau of Weights & Measures in Sèvres, France, as Director of Publications and editor of the international journal *Metrologia*. Upon retirement therefrom in 1989, at the age of 65, he returned to the Washington area and took a three-year temporary post at the National Science Foundation as Program Director for Low-Temperature Physics.

Raymond Hayward, after involvement with his colleagues in several follow-up experiments in the Low-Temperature Laboratory, returned to duty in the Radioactivity Section (Wilfrid B. Mann, Chief). When a separate Nuclear Spectrometry Section was created he was appointed Chief. He wrote a monumental treatise on the dynamics of particles of higher spin ($>1/2$) [13], after which he devoted himself to the study of gravitation. He retired in 1980 at the age of 59.

Dale Hoppes continued experimental studies of beta-particle distributions from oriented nuclei [14] in the Nuclear Spectrometry Section, earning a Ph.D. from The Catholic University of America in 1961. He later returned to the Radioactivity Section, where he was involved in activity and gamma-ray-probability measurements. When Mann retired in 1981, Hoppes took over as Radioactivity Group Leader until his retirement from NIST in 1992 at the age of 64.

Prepared by Ralph P. Hudson.

Bibliography

- [1] C. S. Wu, E. Ambler, R.W. Hayward, D. D. Hoppes, and R. P. Hudson, Experimental test of parity conservation in beta decay, *Phys. Rev.* **105**, 1413-1415 (1957).
- [2] See, for example, D. de Klerk and R. P. Hudson, Installation for Adiabatic Demagnetization Experiments at the National Bureau of Standards, *J. Res. Natl. Bur. Stand.* **53**, 173-184 (1954); E. Maxwell, Isotope effect in the superconductivity of mercury, *Phys. Rev.* **78**, 477 (1950) ; D. de Klerk, R. P. Hudson, and J. R. Pellam, Second sound propagation below 1 °K, *Phys. Rev.* **93**, 28-37 (1954).
- [3] Low-Temperature Alinement of Radioactive Nuclei, *NBS Tech. News Bull.* **40**, 49-51 (1956); see also E. Ambler, R. P. Hudson, and G. M. Temmer, Alignment of Cerium-141 and Neodymium-147 Nuclei, *Phys. Rev.* **97**, 1212-1221 (1955); E. Ambler, R. P. Hudson, and G. M. Temmer, Alignment of Three Odd-A Rare-Earth Nuclei, *Phys. Rev.* **101**, 196-200 (1956).
- [4] T. D. Lee and C. N. Yang, Question of parity conservation in weak interactions, *Phys. Rev.* **104**, 254-258 (1956).
- [5] J. M. Daniels, M. A. Grace, and F. N. H. Robinson, An Experiment on Nuclear Alignment: the Anisotropy of γ -Radiation from Oriented Cobalt-60 Nuclei, *Nature* **168**, 780-781 (1951); E. Ambler, M. A. Grace, H. Halban, N. Kurti, H. Durand, C. E. Johnson, and H. R. Lemmer, Nuclear Polarization of Cobalt 60, *Philos. Mag.* **44**, 216-218 (1953).
- [6] R. L. Garwin, L. M. Lederman, and M. Weinrich, Observations of the failure of conservation of parity and charge conjugation in meson decays: the magnetic moment of the free muon, *Phys. Rev.* **105**, 1415-1417 (1957).
- [7] E. Ambler, R. W. Hayward, D. D. Hoppes, R. P. Hudson, and C. S. Wu, Further Experiments on β Decay of Polarized Nuclei, *Phys. Rev.* **106**, 1361-1363 (1957).
- [8] G. M. Temmer—private communication. Temmer, a gifted scientist of infectious enthusiasm, had played an important part in establishing the solid reputation of the NBS Cryogenic Physics Section's nuclear orientation program, first while employed in the NBS Radioactivity Section, later after moving to the Department of Terrestrial Magnetism.
- [9] Steven Weinberg, Conceptual foundations of the unified theory of weak and electromagnetic interactions, *Rev. Mod. Phys.* **52**, 515-523 (1980); Abdus Salam, Gauge unification of fundamental forces, *ibid.*, pp. 525-538; Sheldon Lee Glashow, Towards a unified theory: Threads in a tapestry, *ibid.*, pp. 539-543..
- [10] R. L. Garwin and T. D. Lee, Obituaries: Chien-Shiung Wu, *Phys. Today* **50** (10), 120,122 (1997).
- [11] E. Ambler, Historical Perspective: 1973-1989, in *NBS/NIST: A Historical Perspective, A Symposium in Celebration of NIST's Ninetieth Anniversary, March 4, 1991*, NIST Special Publication 825, National Institute of Standards and Technology, Gaithersburg, MD (1992) pp. 31-40.
- [12] R. P. Hudson, H. Marshak, R. J. Soulen, Jr., and D. B. Utton, Recent Advances in Thermometry below 300 mK, *J. Low Temp. Phys.* **20**, 1-102 (1975).
- [13] Raymond W. Hayward, *The Dynamics of Fields of Higher Spin*, NBS Monograph 154, National Bureau of Standards, Washington, DC (1976).
- [14] A. T. Hirshfeld and D. D. Hoppes, Transition Mixing Ratios Determined from a Study of the Electron and Gamma-Ray Distributions from Oriented Iridium-192, *Phys. Rev. C* **2**, 2341-2349 (1970).

Effects of Configuration Interaction on Intensities and Phase Shifts

One of the enduring goals of scientific work at the National Institute of Standards and Technology (NIST) has been the expression of measurements in terms related directly to natural phenomena of an invariant and absolute character.

For example, the unit of time, the second, is now defined as exactly 9,192, 631, 770 periods of oscillation of the radiation associated with a specified quantum transition between states of the ^{133}Cs atom. This makes it possible, in principle, for any laboratory to realize the value of the second by preparing a sample of ^{133}Cs in conditions that make it resemble a group of identical atoms unperturbed by their immediate environment.

Of course, such an ideal realization is not attainable in practice. This permanent fact of life has provided steady stream of work over the years for theoretical physicists at NIST: there is always a need for models that can provide better quantitative links between realistic and ideal situations.

Ugo Fano (1912–) is believed to be the first theoretical physicist hired by NIST, and he has certainly been one of the most influential to date. His 1961 paper *Effects of Configuration Interaction on Intensities and Phase Shifts* [1] is one of the most frequently referenced journal articles by a NIST author, having been cited over 3200 times in the scientific literature. This paper treats a subject of fundamental interest to metrology and physics: the excitation spectra of quantum-mechanical systems. Its key result, the simple formula given in Eq. (3) below, is now well known to physicists as the “Fano profile” or “Fano line shape.” It addresses the challenge of expressing observed phenomena in a concise manner that can be derived from first principles. The celebrity enjoyed by this formula derives from the basic importance of the systems it describes, its wide-ranging practical utility, and the historical context in which it emerged. These aspects are discussed in turn below, though they cannot be entirely disentangled.

Among the phenomena key to the early development of quantum mechanics were atomic spectra, i.e., the colors of light absorbed or emitted by free atoms. Such light was found to consist largely of discrete frequencies whose distribution is a characteristic property of the atomic species involved (see Fig. 1). The existence of these discrete frequencies led Niels Bohr [2] to postulate a model of atomic structure in which the atom can subsist only in certain states of well-defined energy,

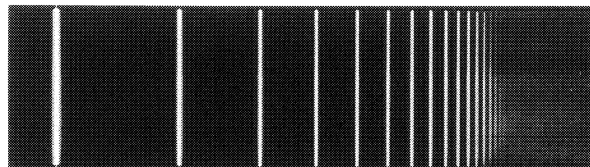

Fig. 1. Visible emission spectrum of the hydrogen atom (spectral lines of the Balmer series). The atomic radiation has been dispersed by a spectral grating and projected onto a photographic plate, to show the discrete frequency components of the radiation. The frequency increases to the right, with white indicating higher intensity (i.e., this is a photographic positive). If viewed by the eye, these lines would appear blue-violet. Figure courtesy of Prof. C. R. Vidal.

although transitions between such states can be induced. Transitions between two states may be associated with accompanying optical radiation, of angular frequency $\omega_0 = 2\pi\Delta E/h$, where ΔE is the difference in energies of the two states, and h is Planck’s constant. At this level of detail, the modern concept of atomic structure is the same as Bohr’s. Thus, accurate data on intrinsic atomic frequencies has great fundamental and practical value. For example, as noted above, such frequencies now provide the legal definition of the second. NIST has for many years maintained a program to generate, evaluate, and maintain a database of relevant atomic spectral properties; that effort is summarized elsewhere in this volume.

Bohr’s basic idea, that transitions between atomic states are associated with radiation of a definite frequency, needs to be broadened somewhat to describe phenomena actually encountered in the laboratory. For example, if one prepares a sample of atoms in a high-energy state, they may make transitions to a lower-energy state by emission of optical radiation. This process will take place over some period of time. Under simplifying but widely applicable assumptions, Viktor Weisskopf and Eugene Wigner [3] showed that quantum mechanics describes the time dependence of the intensity of emitted radiation, $I(t)$, as following the law of *exponential decay*,

$$I(t) \sim \exp(-\Gamma t), \quad (1)$$

where t is the time, measured from the moment of state preparation, and Γ is a rate constant that can be regarded as the inverse of the lifetime of the higher state. This law

expresses a simple idea: the instantaneous probability of decay of a given atom is independent of the time t at which it occurs. Exponential decay is encountered in a number of physical systems, such as the natural transmutation of radioactive elements.

An alternative mode of observation of exponential decay is the resolution of its frequency spectrum. This is a straightforward and convenient practice in optical spectroscopy, where the various frequency components of radiation may be spatially dispersed by reflecting it from a diffraction grating, or by passing it through a prism, and projecting it onto a screen, photographic plate, or detector array. By this means, the spectrum of a white light source is spread out into the familiar rainbow pattern. On the other hand, the spectrum of an atomic radiation governed by the decay law of Eq. (1), exhibits the ‘‘Lorentzian’’ profile, or line shape,

$$I(\omega) \sim 1/[(\omega - \omega_0)^2 + (T/2)^2], \quad (2)$$

where $I(\omega)$ is the intensity at the angular frequency ω , and ω_0 , as stated above, is proportional to the difference in energy between atomic states. In this representation, T plays the role of the ‘‘width’’ of the spectral feature. This expresses Heisenberg’s uncertainty principle: the energy of a state is indeterminate by an amount inversely proportional to its lifetime. For most optical spectra generated by atoms, the ratio T/ω_0 is of the order 10^{-6} . Thus the human eye would perceive the spectrum of Eq. (2) as being a remarkably pure (monochromatic) and bright color, localized at the appropriate position on the viewing screen. However, if examined in detail, atomic spectra can exhibit significant deviations from the form of Eq. (2). The differences are due to the actions of physical processes neglected in the simplifying assumptions mentioned above.

Fano’s 1961 treatment deals with one of the more important classes of such processes: those in which there are alternative pathways for a transition between atomic states. In quantum mechanics, the existence of alternative pathways invariably gives rise to the phenomenon of *interference*: the probability amplitudes associated with travel along the different paths combine with a phase relationship, just as the crests and troughs of classical wave motion can combine to yield a null displacement. In the model considered by Fano, which has been found to have broad applicability, the interference phenomenon inevitably gives rise to a ‘‘dark spot,’’ i.e., the spectral intensity vanishes at a particular frequency. The line shape formula derived by Fano, in his chosen notation, takes the form

$$I(\varepsilon) \sim (q + \varepsilon)^2 / (1 + \varepsilon^2), \quad (3)$$

where $\varepsilon = 2(\omega - \omega_0)/T$ is the angular frequency, measured from the line center ω_0 in units of T , and q is a parameter that describes the interference between pathways. When q is much greater than 1, one of the pathways has the predominant transition amplitude, and Eq. (3) becomes equivalent to Eq. (2) in the region where the signal is strongest.

Fano was first motivated to understand this phenomenon 25 years previously, as a student of Enrico Fermi in Rome. Fermi suggested to Fano that, as a research project, he should try to understand photo-absorption spectra of the noble gases that had recently been observed by Hans Beutler of the University of Berlin [4].

Beutler’s spectra exhibited broad, highly asymmetric absorption series, quite uncharacteristic of atomic spectra known at the time. In contrast to the well-separated, sharp features visible in Fig. 1, Beutler’s spectra showed structures whose width was comparable to their separation.

The origin of this phenomenon was correctly proposed by Beutler to be associated with the phenomenon of *autoionization*, which had previously been identified in atomic spectra by Ettore Majorana [5] and Allen Shenstone [6].

Autoionization occurs upon excitation of an electronic configuration that has an energy higher than that needed to ionize (i.e., remove one electron from) the atom. For example, two atomic electrons may be excited, with a total energy that is sufficient to access an alternative configuration, in which one of the electrons relaxes to a state of lower energy, while the other escapes from the atom. This phenomenon is analogous to a possible, though we hope unlikely, rearrangement of the Solar System, in which the energy released by a contraction of the orbit of Jupiter could be used to liberate the Earth from its orbit about the Sun. In the simplest case of autoionization of a state of two excited electrons, the two interfering quantum-mechanical pathways may be envisaged as follows. One involves the direct ejection of one electron from the atom, leaving behind a positively-charged ion; the other generates a state of two excited electrons, which then relaxes by energy exchange to yield the same final state, a free electron and a positive ion.

In a paper published in 1935 [7], Fano showed that spectral profiles of the type observed by Beutler could indeed be generated by quantum mechanical interference in autoionization, and he presented a formula equivalent to that of Eq. (3). However, his presentation did not involve a quantitative analysis of Beutler’s data, which was quite complicated, and still, in its time, somewhat of an anomaly in atomic spectroscopy. When Fano returned to this class of problems in 1961, key developments in experimental technique had elevated it to a frontier research area of atomic physics.

The new experimental situation of the 1960s evolved along two fronts, on both of which NIST made pioneering contributions that would be adopted world-wide: high-resolution electron spectroscopy, and the application of synchrotron radiation.

John Simpson and Chris Kuyatt led the electron spectroscopy effort in the Electron Physics Section at NIST. They designed electron current sources and detectors that enabled electron scattering by atoms to be investigated in unprecedented detail [8]. Among the signal achievements of this technique was the identification of numerous “negative ion resonances” analogous to the doubly-excited electronic states encountered in photoabsorption. An electron colliding with an atom can lose energy by exciting an atomic electron, and be captured by the field of the residual ion. This can give rise to a transient state in which the incident and excited electrons orbit the positively charged ion core, which subsequently decays by the capture of one electron and the release of the other. This situation provides for interference of two quantum-mechanical amplitudes: one for direct scattering of the incident electron, the other involving the temporary capture/excitation process, which results eventually in a scattered electron. The experimental data treated explicitly by Fano in his 1961 paper were in fact provided by such an experiment. The formation of these resonances was mediated by *correlation* of electronic motions, a phenomenon not encompassed by the traditional “mean field” concepts of atomic structure. The study of such resonances therefore provided insight into unexplored avenues of atomic and molecular physics, which developed as a major research theme in the 1960s with interest extending to the present day.

In the early 1960s the emergence of synchrotron radiation sources greatly expanded the range of optical spectroscopy. At NBS, which played a leading role in the field, the development of a synchrotron radiation source was an offshoot of a program of investment in betatron electron accelerators which started in the late 1940s. The betatrons were originally obtained to provide high-energy electron beams for the production of x rays. These accelerators also yielded, at first as an unappreciated byproduct, a broad band of synchrotron radiation spanning the electromagnetic spectrum from the radio to the x-ray domains. This broad-band capability was not matched by any other laboratory-based radiation source; in particular, synchrotron radiation provided exceptional coverage of the far ultra-violet spectral region, i.e., radiation with wavelengths between about 5 nm and 150 nm, vs the 500 nm wavelength characteristic of visible light. Far ultraviolet radiation has sufficient energy to cause multiple electron excitation in all elements, so that electronic states of the type observed by Beutler would become ubiquitous rather than exceptional.

Robert Madden was hired by NBS to head the Far Ultraviolet Physics Section and was charged with converting one of the betatron machines into a dedicated source of synchrotron radiation for far ultraviolet spectroscopy and radiometry, the Synchrotron Ultraviolet Radiation Facility (SURF). In collaboration with Keith Codling, David Ederer, and others, Madden made numerous pioneering explorations of this spectral region. The first major results of this work are shown in Fig. 2: the absorption spectra of helium, neon, and argon gas [9]. The helium spectra were particularly striking, because they confounded initial theoretical expectations that two series of lines would be observed, rather than the single one displayed here. A companion publication by John Cooper, Fano, and Francisco Prats [10] showed that effects of electron correlation would tend to favor strongly transitions to one of the two series. This result hinted at the existence of characteristic features of two-electron dynamics that might be found in other spectra; this became a prominent theme in atomic physics during the next two decades and is still of interest today.

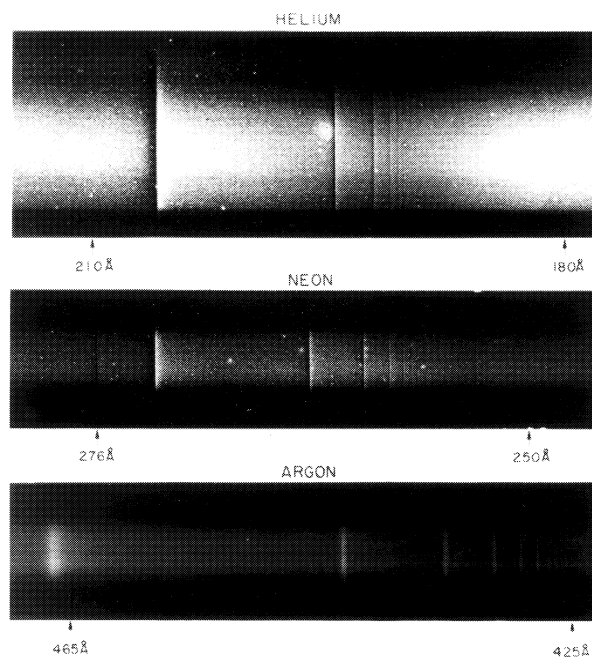

Fig. 2. Absorption spectra of helium, neon, and argon atoms in the extreme ultraviolet spectral region, from [9]. These are images of photographic plates exposed to radiation from the NBS electron synchrotron (now the Synchrotron Ultraviolet Radiation Facility—SURF). The synchrotron radiation was passed through a gas cell and then dispersed by a diffraction grating to show the dependence of absorption upon wavelength (which is indicated in Ångstrom units: $1 \text{ \AA} = 10^{-10} \text{ m}$). Increased blackness indicates increased absorption by the gas. Note that in contrast to Fig. 1, these spectral lines clearly exhibit asymmetric profiles.

An example [11] of the application of the Fano profile formula to the synchrotron radiation data is shown in Fig. 3. The quantitative determination of the parameters q , ω_0 , and Γ that are obtained from this type of analysis is essential for comparison of experiment and theory, or for comparison of experiments of two different types. For example, Fig. 3 describes an atomic state excited by photoabsorption; the same state can be excited by other means—in fact, it was this very same state, produced by electron-impact excitation, that was analyzed in Fano's 1961 paper—but the values of ω_0 and Γ should be independent of the mode of excitation since they are intrinsic characteristics of the excited state.

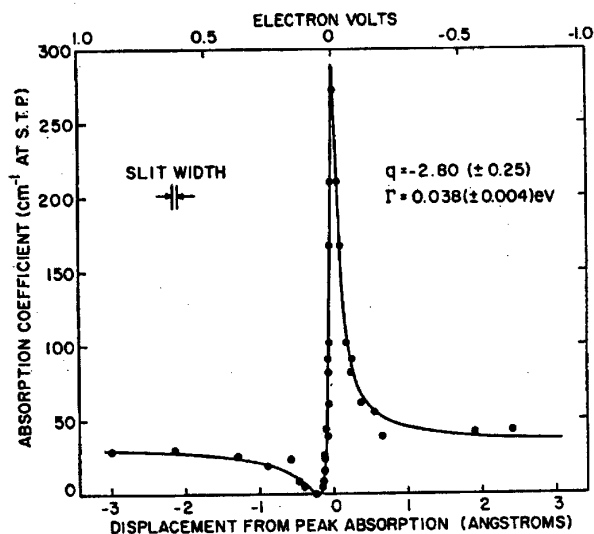

Fig. 3. The absorption coefficient vs. wavelength for the strongest absorption feature of helium (around 206 Å) shown in Fig. 2, from [11]. Note that wavelength increases to the right here, opposite to the display of Fig. 1. The points are experimental data; the solid line is a fit to the Fano profile formula (Eq. 2), with the values q and Γ as indicated. This feature is associated with excitation of the $2s2p\ ^1P^0$ state of the helium atom.

Ugo Fano, who did his graduate work in Italy under Fermi in the early 1930s, was hired by NBS in 1946 with a charge to build up the fundamental science base of the x-ray program. In his 19 years at NBS he provided guidance and inspiration to many of the Bureau's physicists and chemists. After moving to the University of Chicago in 1965, he led his graduate students in the detailed analysis of noble-gas photoabsorption spectra. The analysis of these spectra was a noteworthy achievement of multichannel quantum defect theory, developed by Fano and coworkers along lines laid out by Michael Seaton. This theory had a pronounced influence on high-resolution laser spectroscopy in the 1970s and

1980s; its development is summarized in two articles in the February 1983 issue of *Reports on Progress in Physics* [12].

At NIST, the Fano profile formula evokes memories of a remarkably productive era of atomic and electron physics, one in which there was strong interplay between theory and experiment, as well as between electronic and optical spectroscopy. Many legacies of this era are visible in NIST programs today. For example, the Electron Physics Section spawned the topografiner project, work on resonance tunneling in field emission, and the development of spin-polarized electron sources and detectors—all of which are described elsewhere in this volume. The success of the SURF synchrotron source inspired to the worldwide development of synchrotron radiation as a research tool. SURF has since gone through two major upgrades and today serves as the nation's primary standard for source-based radiometry over a wide region of the optical spectrum. Fano's theory of spectral line shapes continues to be applied to a wide range of physical problems: his 1961 paper was cited over 150 times in the scientific literature in 1999.

Prepared by Charles W. Clark.

Bibliography

- [1] U. Fano, Effects of Configuration Interaction on Intensities and Phase Shifts, *Phys. Rev.* **124**, 1866-1878 (1961).
- [2] N. Bohr, On the constitution of atoms and molecules, *Philos. Mag.* **26**, 1-25 (1913).
- [3] V. Weisskopf and E. Wigner, Berechnung der natürlichen Linienbreite auf Grund der Diracschen Lichttheorie, *Z. Phys.* **63**, 54-73 (1930).
- [4] H. Beutler, Über Absorptionsserien von Argon, Krypton und Xenon zu Termen zwischen den beiden Ionisierungsgrenzen $^2P^0_{3/2}$ und $^2P^0_{1/2}$, *Z. Phys.* **93**, 177-196 (1935).
- [5] Ettore Majorana, Teoria dei tripletti ρ' incompleti, *Nuovo Cimento, N. S.*, **8**, 107-113 (1931).
- [6] A. G. Shenstone, Ultra-ionization potentials in mercury vapor, *Phys. Rev.* **38**, 873-875 (1931).
- [7] Ugo Fano, Sullo spettro di assorbimento dei gas nobili presso il limite dello spettro d'arco, *Nuovo Cimento, N. S.*, **12**, 154-161 (1935).
- [8] C. E. Kuyatt, J. Arol Simpson, and S. R. Mielczarek, Elastic resonances in electron scattering from He, Ne, Ar, Kr, Xe, and Hg, *Phys. Rev.* **138**, A385-A399 (1965).
- [9] R. P. Madden and K. Codling, New autoionizing atomic energy levels in He, Ne, and Ar, *Phys. Rev. Lett.* **10**, 516-518 (1963).
- [10] J. W. Cooper, U. Fano, and F. Prats, Classification of two-electron excitation levels of helium, *Phys. Rev. Lett.* **10**, 518-521 (1963).
- [11] R. P. Madden and K. Codling, Two-electron excitation states in helium, *Astrophys. J.* **141**, 364-375 (1965).
- [12] U. Fano, Correlations of two excited electrons, *Rep. Prog. Phys.* **46**, 97-165 (1983); M. J. Seaton, Quantum defect theory, *Rep. Prog. Phys.* **46**, 167-257 (1983).

Electromagnetic Waves in Stratified Media

This book [1] was written at an important point in the development of applications of electromagnetic (radio) waves to communications, navigation, and remote sensing. Such applications require accurate propagation predictions for a variety of path conditions, and this book provides the theoretical basis for such predictions. The book is based on fundamental research in electromagnetic wave propagation that James R. Wait performed in the Central Radio Propagation Laboratory (CRPL) of NBS from 1956 to 1962. The mathematical theory in the book is very general, and the “stratified media” models are applicable to the earth crust, the troposphere, and the ionosphere. The frequencies of the communication, navigation, and remote sensing applications treated in this book range all the way from extremely low frequencies (ELF) to microwaves.

The mathematical theory of electromagnetic wave propagation is based on Maxwell’s equations [2], formulated by James Clerk Maxwell in the 1860s. Experimental propagation studies in free space [3] and over the earth [4] also go back over 100 years. Research in radio science, standards, and measurements began in NBS in the early 1900s, and the long history of radio in NBS has been thoroughly covered by Snyder and Bragaw [5]. CRPL was moved to Boulder in 1954, and Wait joined the organization in 1955.

The mathematics of electromagnetic wave propagation in stratified (layered) media is very complicated, and progress in propagation theory in the early 1900s was fairly slow. Wait’s book [1] included the most useful theory (much of which he developed) and practical applications that were available in 1962. A hallmark

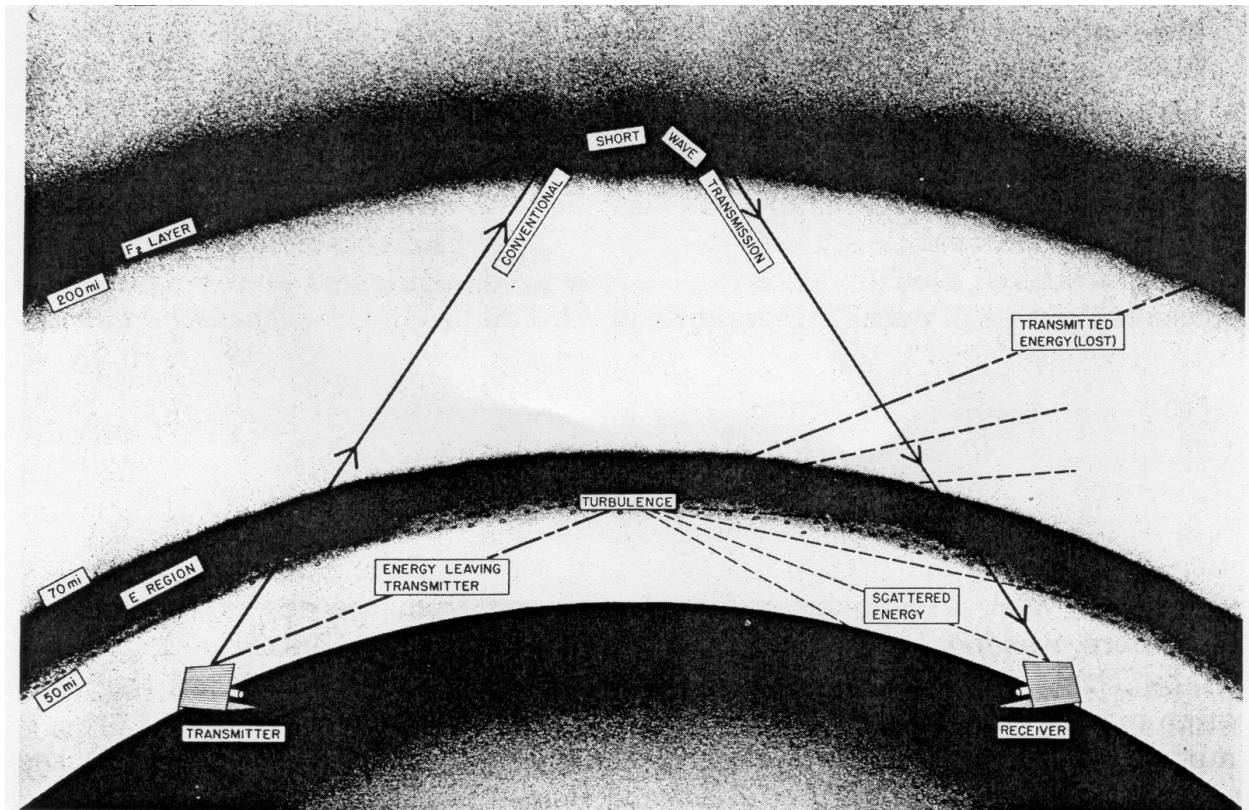

Fig. 1. What it’s all about: In conventional transmission, short waves (in the range of 25 MHz to 60 MHz) are propagated beyond the visible horizon by reflection from the upper layers, or F region, of the ionosphere. In propagation by ionospheric forward scatter the energy of radio waves is scattered by small irregularities in the ionization of the lower ionosphere, i.e., the lower portion of the E layer and below this layer, providing for reception of signals much beyond the line of sight. The diagram is taken from the January 1956 issue of the NBS Technical News Bulletin.

of the book is that the theory was sufficiently general that it has served to guide further theoretical and experimental propagation research to this day. Continuing demand for the book led IEEE Press to reissue it in 1996.

Chapter I provides a general introduction to the book. Chapter II is fundamental to the entire subject because it covers reflection of electromagnetic waves from horizontally stratified media. The incident field can be either a plane wave (as from a distant source) or a spherical wave (as from a nearby antenna). The theory utilizes a novel iterative approach that matches the electric and magnetic field boundary conditions at each layer interface. Then the entire layered medium can be replaced by a single interface with an equivalent surface impedance (ratio of tangential electric and magnetic fields). This approach has been found very useful by many other researchers in simplifying the analysis of complex layered geometries [6], such as printed circuit boards.

Chapter III treats the case where the electromagnetic properties of the reflecting medium vary smoothly, rather than discontinuously as in a multi-layered medium. For some special profiles, such as linear or exponential, the solutions can be given exactly in terms of known mathematical functions. This type of treatment has been particularly useful in obtaining solutions for reflection of pulses from the ionosphere [7].

Whereas the methods in Chapters II and III are exact, approximate methods are developed in Chapter IV. These methods are less accurate, but they have the advantages of simplicity and physical interpretation. In general, these methods track the fields in a manner similar to ray tracing. The approximate methods have been found to be particularly useful for calculating reflections from complex ionospheric profiles [8].

Chapter V brings curved boundaries into the theory by treating wave propagation along a spherical surface. This theory is particularly important for analyzing ground-wave propagation along the surface of the earth [9]. The most important effect that can be predicted using this theory is the rapid attenuation of field strength beyond the shadow boundary. For example, the extent of daytime AM radio coverage can be determined if the ground properties are known. The most general theory can make use of the impedance boundary condition developed in Chapter II to predict field strength as a function of distance even when the curved earth model includes layering [10].

When the ionosphere is added to the curved earth model, mode theory is required to calculate field strength in the earth-ionosphere waveguide. Chapter VI presents a self-contained treatment of mode theory

that starts with very complex mathematics and ends with fairly simple and convenient approximations. The formulations are very general, and the transmitting antennas can be electric or magnetic dipoles of arbitrary orientation. At low frequencies, the earth-ionosphere waveguide acts like a cavity that can resonate [11] and enhance the background noise (typically due to lightning).

The very low frequency (VLF) band is particularly useful for long distance communication and navigation [12] because of the low attenuation rates of the earth-ionosphere waveguide modes. Chapter VII presents VLF approximations that are particularly useful in simplifying the general mode theory of Chapter VI. Numerous attenuation and phase velocity calculations are presented for use in communication and navigation system calculations, and the effects of earth or sea water conductivity are also included. Antenna height is also shown to be important.

The ionosphere is an ionized medium, or plasma. The earth's magnetic field alters the electromagnetic properties of the ionosphere, in particular making it anisotropic. Chapter VIII covers electromagnetic propagation effects encountered in such a magneto-plasma. Again both layering and curvature are taken into account, and practical VLF propagation effects are analyzed in detail. These results have direct application to navigation systems [13].

Chapter IX contains extensive comparisons of theory and measurement at VLF. Interesting effects such as direction of propagation (important because of the earth's magnetic field) and time of day are shown by both theory and experiment [14]. The sources can be either antennas or lightning strikes, and attenuation rates of theory and experiment are generally in good agreement [15].

Chapter X continues in the spirit of Chapter IX except that it covers extremely low frequencies (ELF). Different mathematical approximations are required to fit this lower frequency range (1 Hz to 3000 Hz) even though propagation is still primarily due to a waveguide mode. At this frequency range, the fields can penetrate sea water allowing communication with submarines [16]. Good agreement between theory and experiment [17] is again obtained.

The relationship between waveguide modes and rays is clearly developed in Chapter XI. This provides very useful insight because the ionosphere "sky wave" is often interpreted as an ionospheric reflection for a particular ray path. The mathematical results are sufficiently general that they can be applied to a variety of layered media problems [18].

Chapter XII is particularly important for current applications because it covers propagation of microwaves in the troposphere. General mathematical formulations are obtained, and tropospheric ducting is covered in detail. Microwave propagation in personal communication systems [19] is one of many possible current applications of the theory.

Wait's book synthesized the results of a large number of observations and experiments, some of which had been carried out at the Bureau over the years [5]. Louis W. Austin's investigations on radio wave propagation for the Naval Wireless Telegraphic Laboratory (in close association with, and located at NBS) dated back to 1909. In a Bureau publication of 1911, Austin accounted for anomalies in his observations as being due to absorption of radio signals in the ionized layer above the Earth. In a 1913 paper he explained the increased strength of nighttime signals by reflection from an ionized layer that is less uniform during the day.

The fading of radio signals was of much concern to the Radio Laboratory at NBS and was a puzzlement to operators and scientifically minded observers from the very beginning of radio. In 1920 a cooperative program was initiated by the Radio Laboratory with the American Radio Relay League (ARRL) in a broadside approach by enlisting a large number of radio amateurs to observe fading effects. The vagaries of transmission observed by the growing multitude of listeners in the broadcast frequencies gave added incentive to study fading phenomena. The cooperative program on fading studies with the ARRL and later with several universities and radio stations continued until 1927.

The Bureau's first measurements of the height of ionosphere layers were made in February 1929 by T. R. Gilliland, using a pulse technique. Transmissions came from the Naval Research Laboratory in southeast Washington, with reception at a Kensington, Maryland, field site 5 miles north of the Bureau grounds. By 1930 an organized study of the ionosphere was underway. Thereafter came the many-faceted and extensive program of probing the secrets of the ionosphere and the vagaries of radio propagation under the able direction of John H. Dellinger, who later became Chief of the NBS Central Radio Propagation Laboratory.

James R. Wait (1924–1998) was born in Canada and received his Ph.D. from the University of Toronto in 1951. He joined the Central Radio Propagation Laboratory in Boulder in 1955 and remained in the Boulder Laboratories until 1980. He was a professor at the University of Arizona from 1980 to 1998. He published 8 books and more than 800 papers on electromagnetics

in his long career. Of his many awards, he received IEEE Heinrich Hertz Medal, primarily for the research reported in this book [1].

Prepared by D. A. Hill.

Bibliography

- [1] James R. Wait, *Electromagnetic Waves in Stratified Media*, Pergamon Press, New York (1962).
- [2] Robert Stratman Elliot, *Electromagnetics: History, Theory, and Applications*, IEEE Press, Piscataway, NJ (1993).
- [3] John H. Bryant, *Heinrich Hertz: The Beginning of Microwaves*, Institute of Electrical and Electronics Engineers, New York (1988).
- [4] G. Marconi, Wireless telegraphy, *J. Inst. Electr. Eng.* **28**, 273-316 (1899).
- [5] Wilbert F. Snyder and Charles L. Bragaw, *Achievement in Radio: Seventy Years of Radio Science, Technology, Standards, and Measurement at the National Bureau of Standards*, NBS Special Publication 555, National Bureau of Standards, Boulder, CO (1986).
- [6] Thomas B. A. Senior and J. L. Volakis, *Approximate Boundary Conditions in Electromagnetics*, The Institution of Electrical Engineers, London (1995).
- [7] D. A. Hill and J. R. Wait, Reflection of pulses from a linearly varying ionosphere model with a vertical magnetic field, *Radio Sci.* **6**, 933-937 (1971).
- [8] K. G. Budden, *Radio Waves in the Ionosphere*, Cambridge University Press, Cambridge, England (1961).
- [9] James R. Wait, The ancient and modern history of EM ground-wave propagation. *IEEE Antennas Propag. Mag.* **40** (5), 7-24 (1998).
- [10] David A. Hill and James R. Wait, Ground wave attenuation function for a spherical earth with arbitrary surface impedance, *Radio Sci.* **15**, 637-643 (1980).
- [11] P. V. Bliokh, A. P. Nikolaenko, and Y. F. Fillippov, *Schumann Resonances in the Earth-Ionosphere Cavity*, IEE/Peter Peregrinus Ltd., Stevenage, England (1980).
- [12] Arthur D. Watt, *VLF Radio Engineering*, Pergamon Press, Oxford (1967).
- [13] J. Ralph Johler, On the analysis of LF ionospheric radio propagation phenomena. *J. Res. Natl. Bur. Stand.* **65D**, 507-529 (1961).
- [14] W. L. Taylor, VLF attenuation for east-west and west-east daytime propagation using atmospheric, *J. Geophys. Res.* **65**, 1933-1938 (1960).
- [15] A. Glenn Jean, William L. Taylor, and James R. Wait, VLF phase characteristics deduced from atmospheric wave forms, *J. Geophys. Res.* **65**, 907-912 (1960).
- [16] Michael L. Burrows, *ELF Communications Antennas*, IEE/Peter Peregrinus Ltd., Stevenage, England (1978).
- [17] F. Hepburn, Atmospheric waveforms with very low-frequency components below 1 kc/s known as slow tails, *J. Atmos. Terr. Phys.* **10**, 266-287 (1957).
- [18] L. M. Brekhovskikh, *Waves in Layered Media*, Academic Press, New York (1960).
- [19] K. Siwiak, *Radiowave Propagation and Antennas for Personal Communications*, Artech House, Boston, MA (1995).

“Second Breakdown” in Transistors

This paper [1] provided the first detailed characterization of a serious and, at the time, poorly understood failure mechanism of power transistors, called second breakdown, which could occur well within the power dissipation limits of these devices. It addressed the problem that early transistors (those prior to the bipolar field-effect transistors that are common today) failed while operating well within switching voltage and current conditions that should have posed no threat of failure. The paper was followed by others [2-8] and, in 1967, by a comprehensive review article [9] and bibliography [10]. While second breakdown is still a reliability problem in power transistors and metal oxide semiconductor field-effect transistors (MOSFETs), it is controlled through device design and the specification of safe operating areas that are based on the work reported in this paper. An important aspect of the paper is that it represents the genesis of NIST's support for the semiconductor industry. Work for that industry is now conducted throughout NIST; in particular, there is an Office of Microelectronics Programs and a Semiconductor Electronics Division.

This work was initiated in response to a request to the National Bureau of Standards from the standards arm of the Joint Electron Devices Engineering Councils (JEDEC), operating under the Electronics Industries Association. The reasons cited for their request were several. To achieve an adequate understanding of the mechanism would have required a long-term effort not likely to be undertaken by any individual member company. Nevertheless, it was needed by a large segment of the industry. The literature on second breakdown was slight and inconclusive. Finally, different, controversial opinions, in part due to company prejudices, were widespread. To assist NBS to conduct its research on second breakdown, member companies provided power transistors for testing, copies of reports of their experience, and access to their engineers and scientists concerned with this reliability problem.

In the paper *“Second Breakdown” in Transistors* [1], each of the mechanisms that had been proposed in the literature was examined and shown to be inadequate. A more complete description of the characteristics of second breakdown was given and it was shown that it is a fundamental property of the transistor. On the basis of an observed delay time before the initiation of the breakdown, it was proposed that the phenomenon is related to a thermal mechanism. It was shown that the onset of

second breakdown cannot be predicted simply in terms of voltage and current, as had been the practice, but that it is important to characterize second breakdown in terms of the energy dissipated in the transistor, and further, that the energy threshold (or delay time) is dependent on other factors such as ambient temperature and the biasing base current of the transistor.

The conclusions in this paper provided the basis for all current methods to specify reliable operating limits of power transistors. These specifications are given in terms of safe areas of operation for collector current and voltage that are dependent on the biasing base current and the switching dynamics.

The literature was slight and inconclusive . . . Controversial opinions were widespread.

July 1995 marked 40 years of NBS/NIST programs to support the semiconductor industry. Quoting a press release issued at the time, “The Commerce Department and the U.S. semiconductor industry next month [July 1995] will celebrate the 40th anniversary of a partnership in a field that has enabled such technological advances as the development of sophisticated diagnostic medical devices, laptop computers, and home bread-making machines. These advances have profited from the support the industry has received in the past 40 years through the semiconductor research program at the Commerce Department's National Institute of Standards and Technology.”

These efforts began in July 1955, when electronics scientist Judson C. French was entrusted by NBS management with a budget of \$10,000 and a mission to see what kind of support NBS could give to the growing transistor industry. French approached the American Society for Testing and Materials and the Electronic Industries Association to help define a need that NBS could fulfill. Each organization identified measurements critical to dealing with the great discrepancies in both manufacturing and product specifications that were still unresolved by member companies. So, armed with a project from each organization, NBS embarked on a new program of measurement research that would,

decades later, inspire the Semiconductor Industry Association to note that “NIST is the only place in the U.S. where the broad range of measurements needed for semiconductor processing are routinely and systematically developed.”

In the early 1970s, NBS was requested by the Defense Advanced Research Projects Agency to help the Defense Department develop integrated circuits with increased performance and reliability levels. Both military and private-sector organizations profited from the measurement improvements. In one case, the investigation of wire bonding of integrated circuits established new procedures, now implemented in commercially available equipment, that increased circuit yields by as much as 35-fold and made possible large military hybrid circuits that utilize more than 500 wire bonds each.

In 1981, Charles River Associates conducted studies to investigate the economic benefits provided by NBS work in semiconductor technology. These studies found that industry respondents received several benefits from the use of NBS results, including improved product reliability, increased production yields, increased ability to meet customer specifications, improved product features, cost reductions, and new directions of company research.

The report concludes that “the overall industry productivity level was approximately one percent higher for the years 1973 to 1977 [which were covered by the studies] than it would have been had the technical information acquired from NBS not been available” and that the median rate of return to the economy and society on investment in the NBS work was 140 percent per year. Later comparisons with industry data showed that NBS had provided four percent of the total industry productivity increase during the period.

Work spawned by reference [1] is profusely evident in industry. NIST’s work on photomask linewidths led to a tenfold reduction of intercompany measurement discrepancies, stimulated the production of new instrumentation, extended the range of use of optical microscopes, and provided techniques and calibration standards that have been adopted industry-wide. All U.S. semiconductor device manufacturers use NIST measurement methods and standards. A study of the benefits of this work estimated a \$30 million annual savings to the photomask producers alone.

NIST designed and built the world’s most accurate ellipsometer to develop and issue standard reference materials for measurement of silicon dioxide layer thicknesses between 10 nm and 200 nm, measurements critical to industry for precise manufacturing control.

NIST stimulated the first marketplace use of integrated circuit test structures, which are devices formed on the wafer during manufacture that can be probed electrically to measure properties of materials, quality of processing steps, device operation, and mechanical properties. Test structures based on electrical measurements have been developed at NIST for measuring dimensions (so-called “critical dimensions”); overlay, a measure of registration between layers of a device; and electrical linewidth with uncertainties in the 10 nm range.

Results of NIST’s methods of evaluating susceptibility to electromigration—which causes the interconnect metal on modern integrated circuits to fail—have been used by at least 14 companies. An independent study reported that benefits to this industry, including reduced production and transaction costs as well as improved research efficiencies, led to an estimated aggregate social rate of return of 117 %.

Harry A. Schafft began his NBS career in 1958 as an Electronics Engineer in the Semiconductor Electronics Division. In addition to his research on second breakdown in transistors, he started a program in 1982 to improve the characterization of interconnect metallizations for their resistance to electromigration. This work resulted in the development of three American Society for Testing and Materials (ASTM) standards and numerous journal publications. His recent work has focused on developing and coordinating techniques for building in the reliability of semiconductor devices by identifying and controlling critical process fabrication parameters. Other areas in which he has made contributions include photovoltaic electric power systems, measurement problems related to wire bonds, and measurement technology required by the cardiac pacemaker industry. He is a Fellow of the the Institute of Electrical and Electronics Engineers (IEEE) and received a Department of Commerce Bronze Medal in 1983 and a Silver Medal in 1992.

Judson C. French joined the National Bureau of Standards in 1948. He conducted and later directed research and development in microwave gas tubes and semiconductor materials and devices prior to his broader assignments in research management. He served as Chief, Electron Devices Section (1968-1973); Chief, Electronic Technology Division (1973-1978); Director, Center for Electronic and Electrical Engineering (1978-1991); and Director (1991-1999) and Director Emeritus (1999), Electronics and Electrical Engineering Laboratory. French has served as a member of the Optoelectronic Computing Systems Center Policy Board at the University of Colorado since 1992 and as

an observing member of the Board of Directors of the National Electronics Manufacturing Initiative, Inc., since 1998. He has co-chaired the Joint Management Committee of the U.S.—Japan Joint Optoelectronics Project since 1992. He is a member of the National Academy of Engineering and a Fellow of the IEEE, and he has received Department of Commerce Silver and Gold Metals and the Edward Bennett Rosa Award of NBS. In 1980 he received the Presidential Rank of SES Meritorious Executive and, in 1984 and 1993, the rank of Distinguished Executive.

Prepared by Harry A. Schafft.

Bibliography

- [1] H. A. Schafft and J. C. French, "Second Breakdown" in Transistors, *IRE Trans. Electron Devices* **ED-9**, 129-136 (1962).
- [2] Harry A. Schafft, *Average Power Dissipated in a Diode Swept Along Its Reverse Characteristic*, NBS Technical Note 240, National Bureau of Standards, Washington, DC (1964).
- [3] H. A. Schafft and J. C. French, Breakdown Characteristics of Semiconductor Materials, *Electro-Technology* **75** (6), 77-83 (1965). [4] H. A. Schafft, Avoiding Second Breakdown, in *Proc. 13th Int. Scientific Congress on Electronics*, Rome, June 1966 (1966) pp. 117-130.
- [5] H. A. Schafft and J. C. French, A Survey of Second Breakdown, *IEEE Trans. Electron Devices* **ED-13**, 613-618 (1966).
- [6] H. A. Schafft and J. C. French, Second Breakdown and Current Distributions in Transistors, *Solid-State Electron.* **9**, 681-688 (1966).
- [7] H. A. Schafft, G. H. Schwuttke, and R. L. Ruggles, Second Breakdown and Crystallographic Defects in Transistors, *IEEE Trans. Electron Devices* **ED-13**, 738-742 (1966).
- [8] H. A. Schafft, Second Breakdown in Transistors, in *Proc. Second Symp. on Reliability in Electronics*, Budapest, October 1968, (1968) p. 225.
- [9] Harry A. Schafft, Second Breakdown—A Comprehensive Review, *Proc. IEEE* **55**, 1272-1288 (1967).
- [10] Harry A. Schafft, *Second Breakdown in Semiconductor Devices—A Bibliography*, NBS Technical Note 431, National Bureau of Standards, Washington, DC (1967).

Stress Relaxation With Finite Strain

Soon after World War II, the development and use of synthetic polymers, such as rubber and plastics, burgeoned. The rapidly expanding uses of these materials demanded a better understanding of their fundamental properties, especially their mechanical properties. At that time engineers were more accustomed to dealing with materials such as metals, which behaved very differently under stress than did polymers. When a reasonable load is placed on a metal, it will bend or deform by an amount uniquely determined by its elastic properties. Sustaining the load for a longer period of time does not produce any further elastic deformation. For synthetic rubbers or polymers, such uniquely determined deformation cannot be assumed to occur. Inevitably, and often dramatically, the deformation corresponding to a given load will change as time progresses. Such behavior is called *time-dependent*.

It was necessary, then, to learn how to deal with time-dependent properties in these new materials, to discover which properties were controlling and controllable, to learn how to measure such properties, and to understand how to handle them in engineering design. What was needed was a rather ambitious undertaking, namely the construction of a fully three-dimensional theory that obeyed the laws of thermodynamics and

that went beyond the assumption commonly known as linearity. The paper *Stress Relaxation with Finite Strain* [1], published in 1962 by Bernstein, Kearsley, and Zapas, was a major milestone in meeting this challenge.

By *linearity* we mean the following: If you double the load, you double the displacements involved in the corresponding deformation. More generally, a model is said to be linear if, when one multiplies a load by any factor, all displacements are multiplied by the same factor. In theoretical models, it is more convenient to deal with relative displacements called strains. Essentially, a strain is a change in a length divided by a reference length. For linearly elastic models, the strain is simply proportional to the stress that produces it. For nonlinear models, such simple and unique proportionality does not occur. That was the fundamental problem for models of synthetic rubber and polymers.

In early work, Herbert Leaderman in the Rubber Section at NBS attempted to adapt his very successful linear models to the new materials. He did this by trying various nonlinear strain measures, with which he reformulated his models. But such stratagems proved to be simply perturbations, or slight variations, on the theme of linear models, and offered only very limited insights into the effects of nonlinearity.



Fig. 1. Louis Zapas, Elliot Kearsley, and Barry Bernstein, ca. 1991.

Beginning in 1962, a fresh attack was made on this problem in the Rheology Section of the Mechanics Division of NBS by a team composed of physicist Elliot A. Kearsley and chemical engineer Louis J. Zapas of the Rheology Section, together with mathematician Barry Bernstein of the Mathematical Physics Section in the Mathematics Division. By allowing for very wide variations in characteristic times and characteristic temperatures, this group observed what appeared to be striking qualitative similarities in the nonlinear viscoelastic behavior of widely different materials. With respect to certain characteristic quantities, the qualitative behaviors of polymeric materials ordinarily treated as solids and of materials ordinarily treated as liquids seemed indistinguishable. Motivated by this observation, the NBS team constructed a phenomenological model of nonlinear viscoelasticity within the following limitations:

- (1) It is inherently nonlinear, not a perturbation of linear viscoelasticity.
- (2) It is consistent with all the geometric and thermodynamic constraints appropriate to the mechanics of a material deforming in three-dimensional space.
- (3) It models the known qualitative characteristics of viscoelastic materials.
- (4) It is based on a generalized micromechanics of viscoelastic materials, but is not tied to the details of any particular material.

This effort resulted in a model representing a material whose responses in shear arise from a time-dependent potential bearing the dimensions of entropy. Furthermore, this potential depends not simply on the current value of deformation, but rather on the whole past-time history of the deformation. In other words, to compute its value at a given time, one needs to know the history of the deformation as a function of time. In producing elastic effects, this potential plays the role of an elastic strain-energy function. It induces an elastic stress in a current configuration derived from a weighted sum of partial stresses arising from the deformations of past configurations to the current configuration. As the current configuration evolves, each particular past configuration recedes in time, and the weight of its contribution to the current stress recedes accordingly, resulting in viscous energy loss.

In addition, the notion of the “material clock” was incorporated. Consider a temperature-sensitive clock that runs faster at higher temperatures than at lower temperatures. Suppose that what determines how long ago in the past a particular event occurred is, to the

material, effectively the time interval on that temperature-sensitive clock rather than the time interval on the temperature-insensitive laboratory clock. Such a conceptual clock, with its rate adjusted appropriately for the material with respect to the laboratory clock, is what one means by a material clock.

The first public presentation of this work occurred at the annual meeting of the Society of Rheology in 1962. At that time, a version of the model suitable for use under isothermal conditions was presented in a series of three talks. This presentation was followed by a summary of the model published as a paper in the 1963 transactions of the Society [1]. Subsequently, a more complete version including thermodynamic considerations was published in the *NBS Journal of Research* in 1964 [2].

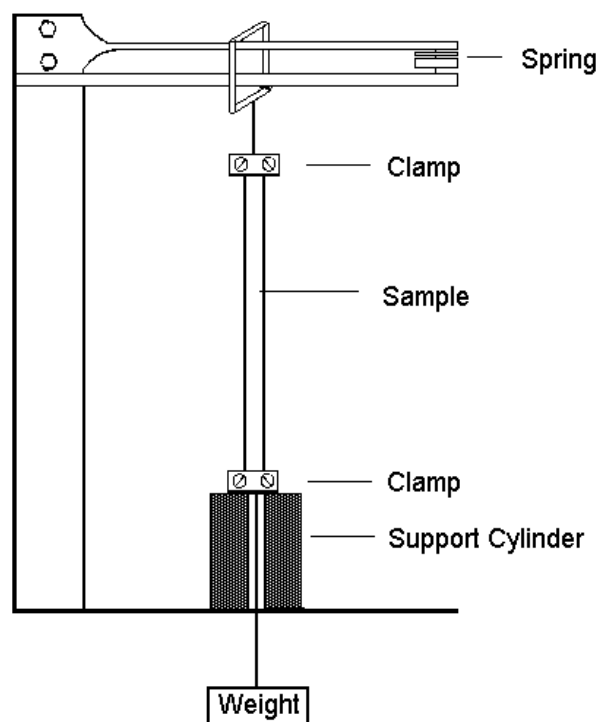

Fig. 2. Schematic of a stress-relaxation apparatus. The rigid support cylinder determines the ratio of final to initial length (extension ratio) of the sample while the displacement of the spring measures the force on the sample.

For the next few years, attention to this model was pursued only at NBS and a few other laboratories where experimental studies were conducted to establish the successes and limitations of the model for treating the mechanics of polymeric materials. However, by 1970, inherent difficulties in alternative competing models led researchers to turn in greater numbers to the NBS

model. The authors had called the model “a perfect elastic fluid” by analogy to the concept of a perfect gas. However, as the number of citations to the 1963 article began to climb, the model became widely known as “the BKZ fluid” or, on occasion, as “the K-BKZ fluid.” During the next decade, the use of the BKZ fluid became ubiquitous among rheologists. By 1988 the BKZ model was so well established in rheological circles that the Society of Rheology, at its annual meeting, held a session entitled “25 Years of the BKZ Theory” to mark the 25th anniversary of its initial publication and to review the subsequent developments. The BKZ model is now expounded in most texts on mechanical properties of materials and is commonly taught in courses for students of polymer science and of chemical and mechanical engineering.

According to the BKZ model, the response of a material to any deformation history can be calculated from measured behavior in stress-relaxation. This is a very convenient property for calculation. Furthermore, the limitations of the BKZ model have been well established. Despite some failings, it has been shown to afford an excellent representation of the mechanical behavior of most polymeric materials in most situations. Consequently, versions of the BKZ model are widely used in finite-element calculations; in designing injection molding and blow molding processes; in film

stretching and extrusion processes; and in designing systems for processing and handling materials with complex rheology. Such processes occur, for example, in the fabrication of plastic objects, in packaging, in food processing, and in the mixing of paints and other coatings. Modifications and ornamentation of the model are still being proposed and tested to overcome the known failings, and the end is not in sight. On the occasion of the 25th anniversary of the publication of the BKZ paper, R. I. Tanner opined in a presentation [3], “I believe that we will continue to use the (BKZ) theory, . . . I do not think that the theory will fade away rapidly since it is the optimal type of single-integral equation”

Prepared by Elliot Kearsley and Barry Bernstein.

Bibliography

- [1] B. Bernstein, E. A. Kearsley, and L. J. Zapas, A Study of Stress Relaxation with Finite Strain, *Trans. Soc. Rheol.* **VII**, 391-410 (1963).
- [2] B. Bernstein, E. A. Kearsley, and L. J. Zapas, Thermodynamics of Perfect Elastic Fluids, *J. Res. Natl. Bur. Stand.* **68B**, 103-113 (1964).
- [3] R. I. Tanner, From A to BKZ in Constitutive Relations, *J. Rheol.* **32**, 673-702 (1988).

Realistic Evaluation of the Precision and Accuracy of Instrument Calibration Systems

Prior to the publication of *Realistic Evaluation of the Precision and Accuracy of Instrument Calibration Systems* by Churchill Eisenhart [1], the terms “precision” and “accuracy” were used in a qualitative manner to characterize measurements. These terms appeared in many American Society for Testing Materials (ASTM) standards long before any common agreement or understanding had been reached as to their meanings and consequences. Circa 1950, individuals and organizations began concerted efforts to right this situation. Churchill Eisenhart was drawn to this issue as it related to calibrations, which he called refined measurement methods. As Chief of the Statistical Engineering Laboratory (SEL), Applied Mathematics Division, he set out to put the concepts of accuracy and precision on a solid statistical basis for NBS scientists and metrologists.

His paper on the subject, published in 1961 [1], was to become the preeminent publication on the subject. With impeccable scholarship and commitment to detail, Eisenhart synthesized his own work [2] and the writings of statistical theorists and practitioners, Walter Shewhart [3], Edwards Deming, Raymond Birge [4], and R. B. Murphy [5], into concepts of quality control that could be applied to measurement processes.

Three basic concepts in the paper were immediately accepted by metrologists at NBS, namely: (1) a measurement process requires statistical control; (2) statistical control implies control of both reproducibility and repeatability; and (3) a measurement result requires an associated statement of uncertainty that includes any possible source of bias.

In this paper, for the first time, measurements themselves were described as a process whose output can be controlled using statistical techniques. Eisenhart reinforced the conclusion, probably first drawn by Murphy [5], that “Incapability of control implies that the results of measurement are not to be trusted as an indication of the physical property at hand—in short, we are not in any verifiable sense measuring anything”—when he says, “a measurement operation must have attained what is known in industrial quality control language as a state of statistical control . . . before it can be regarded in any logical sense as measuring anything at all.”

Eisenhart’s paper, coupled with work by other SEL statisticians, had a lasting and profound effect on



Fig. 1. Churchill Eisenhart.

measurement processes at NBS/NIST and throughout the metrology community. W. J. Youden revolutionized interlaboratory testing with methods for ruggedness testing [6] and for quantifying bias in test methods [7] and scientific measurements [8]. In his work with industrial chemists and ASTM committees, Youden left a huge body of literature on the subject of bias. His papers, which are too numerous to cite, have a common theme in the use of experimental design to shed light on sources of error in a measurement process. He was especially interested in interlaboratory testing as a means of uncovering biases in measurement processes [9], and the so-called Youden plot [10] has become an accepted design and analysis technique throughout the world for interlaboratory comparisons.

Statistical activity at NBS in the 1950s was characterized by the development of experimental designs; in the

late 1950s, with the advent of electronic computing, Joseph Cameron created calibration designs with provisions for check standards for the NBS calibration laboratories. Cameron, Youden, and Eisenhart then merged the check standard concept with quality control procedures in Eisenhart's paper to form a cohesive practice, known as measurement assurance [11-13], as a means of tying measurement results to a reference base and quantifying the uncertainty relative to the reference base. The first documentation of a measurement assurance program in a NBS calibration laboratory appears to be a tutorial by Paul Pontius and Joseph Cameron [14] on mass calibrations. Measurement assurance programs now abound in metrology and are regularly applied to measurements as diverse as dimensional measurements of gage blocks standards and semiconductor devices [15-16].

Eisenhart's exposition of sources of error in a measurement process led to the accepted practice of the day for reporting uncertainty as described by Harry Ku [17], and a paper co-authored with Ron Collé and Ku [18] was a forerunner of the 1993 *ISO Guide to the Expression of Uncertainty in Measurement* [19] and the companion NIST guideline by Barry Taylor and Chris Kuyatt [20].

Churchill Eisenhart was brought to NBS from the University of Wisconsin in 1946 by Edward Condon, Director of NBS, to establish a statistical consulting group to "substitute sound mathematical analysis for

costly experimentation." He was allowed to recruit his own staff and, over the years, he brought many notable and accomplished statisticians to SEL. He served as its Chief from 1947 until his appointment as Senior Research Fellow in 1963. He retired in 1983, and his final contribution to NIST was the formation of the Standards Alumni Association, which he headed until his death in 1994.

In its early days, SEL was drawn into outside studies as NBS became more involved in industrial activities. The study that brought the most controversy to NBS and the most recognition to Eisenhart's group was the AD-X2 battery additive case. The NBS Director, A.V. Astin, had been pressured by various senators and the battery additive producer to run a test of the additive. Under extreme time constraints, the statisticians came up with appropriate experimental designs for the tests [21] and assigned the treatment of additive or no-additive to 32 batteries blindly and at random. The experiments, run by the Electricity Division, confirmed that the additive had no significant positive effect on batteries, but in what was quickly to become an interesting sidelight of history, the Assistant Secretary of Commerce for Domestic Affairs announced that Astin had not considered the "play of the marketplace" in his judgment and relieved him as Director of NBS. Eventually, the National Academy of Sciences was called in to review NBS's work, which was labeled first rate, and Astin was reinstated [22].

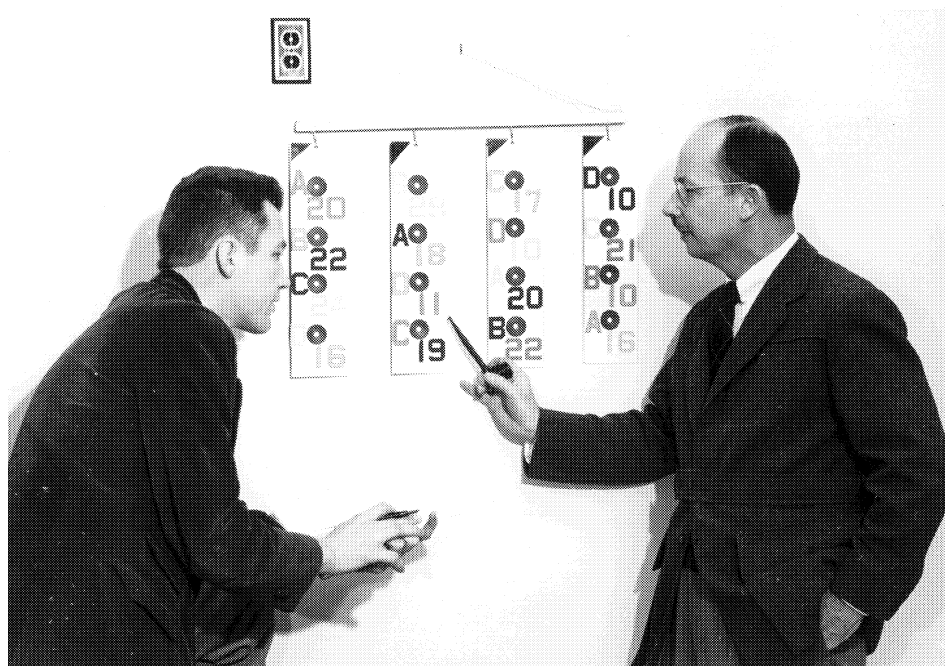

Fig. 2. Joseph Cameron and Jack Youden of the Statistical Engineering Laboratory explaining a measurement design.

Over his long and illustrious career, Eisenhart was awarded the U. S. Department of Commerce Exceptional Service Award in 1957; the Rockefeller Public Service Award in 1958; and the Wildhack Award of the National Conference of Standards Laboratories in 1982. He was elected President of the American Statistical Association (ASA) in 1971 and received the Association's Wilks Memorial Medal in 1977. Eisenhart was honored with an Outstanding Achievements Award of the Princeton University Class of 1934 and with Fellowships in the ASA, the American Association for the Advancement of Science, and the Institute of Mathematical Sciences. He was a long-time member of the Cosmos Club.

In this later years, Eisenhart indulged his interest in the history of statistics, and particularly in the evolution of least-squares. He corresponded regularly with those who had like interests. In a memorial lecture given in his honor at the National Institute of Standards and Technology on May 5, 1995, Stephen Stigler [23] says that "I wrote to him that he had set the standard for scholarly research in our field, and that is how I thought of him—the standard."

Prepared by M. Carroll Croarkin.

Bibliography

- [1] Churchill Eisenhart, Realistic Evaluation of the Precision and Accuracy of Instrument Calibration Systems, *J. Res. Natl. Bur. Stand.* **67C**, 161-187 (1963).
- [2] C. Eisenhart, The Reliability of Measured Values—Part I, Fundamental Concepts, *Photogramm. Eng.* **XVIII**, 542-554 (1952).
- [3] Walter A. Shewhart, *Statistical Method from the Viewpoint of Quality Control*, The Graduate School, U.S. Department of Agriculture, Washington, DC (1939).
- [4] W. Edwards Deming and Raymond T. Birge, On the Statistical Theory of Errors, *Rev. Mod. Phys.* **6**, 119-161 (1934); with additional notes dated 1937 (The Graduate School, Department of Agriculture, Washington, DC).
- [5] R. B. Murphy, On the Meaning of Precision and Accuracy, *Mater. Res. Stand.* **1**, 264-267 (1961).
- [6] W. J. Youden, The Collaborative Test, presented at the referees' Seventy-sixth Annual Meeting of the Association of Official Agricultural Chemists, Washington, DC, Oct. 16, 1962.
- [7] W. J. Youden, How to Evaluate Accuracy, *Mater. Res. Stand.* **1**, 268-271 (1961).
- [8] W. J. Youden, Systematic Errors in Physical Constants, *Phys. Today* **14** (9), 32-43 (1961).
- [9] W. J. Youden, Experimental Design and ASTM Committees, *Mater. Res. Stand.* **1**, 862-867 (1961).
- [10] W. J. Youden, The Sample, the Procedure and the Laboratory, *Anal. Chem.* **32** (13), 23A-37A (1960).
- [11] J. M. Cameron, *Measurement Assurance*, NBS Internal Report 77-1240, National Bureau of Standards, Washington, DC (1977).
- [12] Brian Belanger, *Measurement Assurance Programs Part I: General Introduction*, NBS Special Publication 676-I, National Bureau of Standards, Washington, DC (1984).
- [13] Carroll Croarkin, *Measurement Assurance Programs Part II: Development and Implementation*, NBS Special Publication 676-II, National Bureau of Standards, Washington, DC (1984).
- [14] P. E. Pontius and J. M. Cameron, *Realistic Uncertainties and the Mass Measurement Process: An Illustrated Review*, NBS Monograph 103, National Bureau of Standards, Washington, DC (1967).
- [15] Carroll Croarkin, John Beers, and Clyde Tucker, *Measurement Assurance for Gage Blocks*, NBS Monograph 163, National Bureau of Standards, Washington, DC (1979).
- [16] Carroll Croarkin and Ruth N. Varner, *Measurement Assurance for Dimensional Measurements on Integrated-Circuit Photomasks*, NBS Technical Note 1164, National Bureau of Standards, Washington, DC (1982).
- [17] Harry H. Ku, Expressions of Imprecision, Systematic Error, and Uncertainty Associated with a Reported Value, *Measurements & Data*, **2** (4), 72-77 (1968).
- [18] Churchill Eisenhart, Harry H. Ku, and R. Collé, *Expression of the Uncertainties of Final Measurement Results: Reprints*, NBS Special Publication 644, National Bureau of Standards, Washington, DC (1983).
- [19] *Guide to the Expression of Uncertainty in Measurement*, International Organization for Standardization, Geneva, Switzerland (1993).
- [20] Barry N. Taylor and Chris E. Kuyatt, *Guidelines for Evaluating and Expressing the Uncertainty of NIST Measurement Results*, NIST Technical Note 1297, National Institute of Standards and Technology, Gaithersburg, MD (1994).
- [21] *Battery AD-X2*, Hearings before the Select Committee on Small Business, United States Senate, Eighty-Third Congress, First Session, On Investigation of Battery Additive AD-X2, Washington, 1953.
- [22] *NBS Report 2447 on Battery Additive AD-X2*, U.S. Government Printing Office, Washington, DC (1953).
- [23] S. M. Stigler, Statistics and the Question of Standards, *J. Res. Natl. Inst. Stand. Technol.* **101**, 779-789 (1996).

Experimental Statistics

NBS Handbook 91: Experimental Statistics [1] was first published in 1963. The material for the book was originally commissioned and printed in a limited edition by the U.S. Army as a series of five Army Ordnance Pamphlets OSRDDP 20-110-114. The publication was prepared in the Statistical Engineering Laboratory (SEL) of NBS under a contract with the former Office of Ordnance Research. Although originally intended for the needs of the Army, it proved to be equally useful to research and development groups, both within and outside the government.

The Handbook is organized in five sections; namely,

1. Basic Statistical Concepts and Analysis and Interpretation of Measurement Data
2. Standard Techniques for Analysis and Interpretation of Enumerative and Classificatory Data
3. The Planning and Analysis of Comparative Experiments
4. Special Topics
5. Tables

It is a monumental work which brings together under one cover the combined experience and expertise of the Statistical Engineering Laboratory. Mary Gibbons Natrella was principal author with overall responsibility for the entire publication, but there are contributions on polynomial and multivariable relationships, sensitivity testing, use of transformations, and expression of uncertainties by other members of the SEL. Chapters 1, 20, and 23 were written by Churchill Eisenhart, founding father of the SEL; Chapter 6 was written by Joseph Cameron, who later became Chief of SEL, and Chapter 10 is based on material prepared by Mary Epling. Some original tables were prepared by Paul Somerville; Norman Severo assisted with Section 2, and Shirley Young Lehman helped with the collection and analysis of examples.

Mary Natrella had a special gift for elucidating difficult statistical concepts, and these expositions are the strength of the book. The workbook style of the volume probably accounts for its popularity and acceptance by statisticians and non-statisticians alike. It is replete with examples; the page for each example is divided, with the statement of the problem and recommended solution on the left-hand side and detailed step-by-step calculations on the right-hand side. Mary



Fig. 1. Mary Gibbons Natrella.

Natrella also believed in attention to detail. The Foreword states that “some procedures in the Handbook have been explained and illustrated in detail twice: one for the case where the important question is whether the performance of a new material, product, or process exceeds an established standard; and again for the case where the important question is whether its performance is not up to the specified standard.”

The Handbook was an immediate success at NBS, in the Army, and throughout the Department of Defense. It eventually received wide acclaim in other government agencies, industry, and universities. Churchill Eisenhart was fond of quoting a statistician who said that “the best thing about the Handbook is that it is correct.”

The Handbook is recognized for its deep and long-lasting impact on the application of statistics to the planning and analysis of scientific experiments. It was reprinted in 1983 for commercial sale by Wiley Interscience as part of its Selected Government Publications series. In 1985, the American Society for Metals published a condensation of four chapters on planning and

analysis of comparative experiments as part of the Statistics Section of Volume 8 of the 9th edition of the ASM Handbook. It has been NIST's second-best selling publication, after the *Handbook of Mathematical Functions*, which is covered elsewhere in this volume. The material is still current after more than thirty years, and this year alone it received close to forty journal citations as measured by the Science Citation Index.

NIST still receives requests for this book, and its contents are the basis for training courses taught by the Statistical Engineering Division (SED) and companies such as SEMATECH that are involved in technology development. It has proved such an inspiration that a few years ago Patrick Spagon of the Statistical Methods Group of SEMATECH approached SED with a proposal for updating and recreating the book with examples directed towards the semiconductor industry. That proposal has evolved into a publication for the World Wide Web [2] that is currently under development by a

team that includes: James Filliben, William Guthrie, Alan Heckert, and Carroll Croarkin of SED; Paul Tobias, head of the Statistical Methods Group, and Chelli Zey of SEMATECH; Barry Hembree of AMD; and Ledi Trutna, a private consultant.

Mary Natrella joined the Statistical Engineering Laboratory of NBS as a mathematical statistician in April 1950 after Churchill Eisenhart noticed her work as a sampling inspection expert in the U.S. Navy's Bureau of Ships. At the Navy, she worked on a team that developed the now famous MIL-STD-105A, Sampling Procedures and Tables for Inspection by Attributes (1950), which was to become a government wide standard. Her "Report of Proceedings of the Subcommittee for Preparation of MIL-STD-105A," issued as a companion document to the standard, was distributed to government groups developing sampling inspection plans, as well as to professional and technical organizations, and was still in demand in the 1970s.

Additional Diagnostic Plots

Further residual diagnostic plots are shown below. The plots include a run order plot, a lag plot, a histogram, and a normal probability plot. Shown in a two-by-two array like this, these plots comprise a 4-plot of the data that is very useful for checking the assumptions underlying the model-building methodology.

Dataplot 4plot

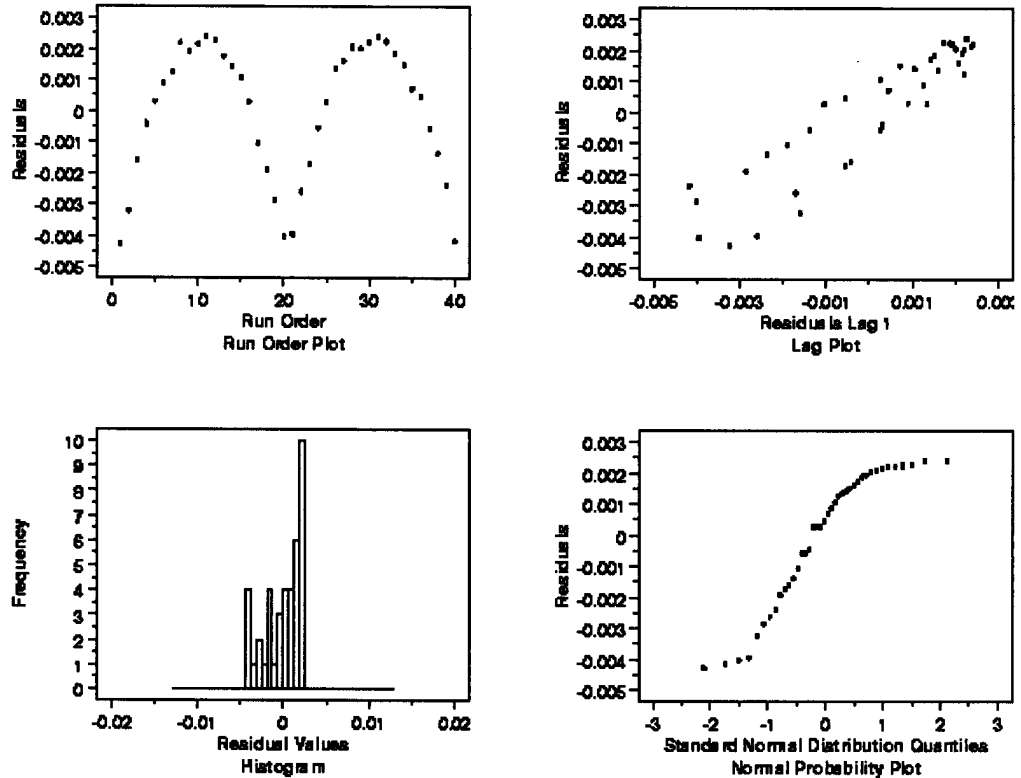

Fig. 2. Partial page from *NIST/SEMATECH Engineering Statistics Handbook* showing graphical techniques for deciding if the relationship between two variables is linear.

The SEL was a pioneering group dedicated to application in the physical sciences of the statistical methods developed by R. A. Fisher, J. Neyman, and E. S. Pearson in England and Walter Shewhart in the United States. Mary Natrella served as a consultant on statistical planning and analysis of experiments to NIST scientists, and her training course on “Statistics of Measurement” was heavily attended for many years. Her most notable publication is *Handbook 91*, which was 7 years in preparation and required all her talents as teacher and consultant. During this time, Mary also contributed several sections to *NBS Special Publication 300* [3] and worked with Carroll Brickenkamp and Steve Hasko of the NIST Office of Weights and Measures on *NBS Handbook 133: Checking the Net Contents of Packaged Goods* [4], which has been adopted by the National Conference on Weights and Measures. She performed her last service for the Statistical Engineering Division by serving as Acting Division Chief for the 2 years prior to her retirement in 1986.

The 1980’s brought the culmination of Mary’s career, with recognition on many fronts. She was elected a Fellow of the American Statistical Association (ASA) in 1981. In 1982, she received the Department of Commerce’s Superior Federal Service Award. She was a long-time member of American Society for Testing Materials (ASTM) Committee E-11 on Quality and Statistics. In 1984, for her work as chairman of Subcommittee E11.03 on Statistical Analysis and Control Techniques, she was awarded the Society’s Award of Merit, which carries the designation of Fellow.

In the year 2000 Mary Natrella has been further honored by the establishment of an endowed scholarship fund which will provide \$1000 scholarships each year for two students to attend the Quality and Productivity Research Conference (QPRC). The scholarships were established by the Quality and Productivity section of the American Statistical Association, under the chairmanship of Veronica Czitrom of Lucent Technologies, with funds donated by Mary’s husband, Joseph V. Natrella, and the QPRC Steering Committee. The purpose is to honor Mary’s 36 years as author, teacher, and consulting statistician and her many contributions to the statistical community.

Prepared by M. Carroll Croarkin.

Bibliography

- [1] Mary Gibbons Natrella, *Experimental Statistics*, NBS Handbook 91, National Bureau of Standards, Washington, DC (1963); reprinted 1966.
- [2] Paul Tobias and Carroll Croarkin (eds.), *NIST/SEMATECH Engineering Statistics Handbook*, (<http://www.itl.nist.gov/div898/handbook/index.html>), National Institute of Standards and Technology (1999).
- [3] Harry H. Ku (ed.), *Precision Measurement and Calibration: Statistical Concepts and Procedures*, NBS Special Publication 300, Vol. 1, National Bureau of Standards, Washington, DC (1969).
- [4] C. S. Brickenkamp, S. Hasko, and M. G. Natrella, *Checking the Net Contents of Packaged Goods*, NBS Handbook 133, Third Edition, National Bureau of Standards, Gaithersburg, MD (1988).

Handbook of Mathematical Functions

The *Handbook of Mathematical Functions with Formulas, Graphs, and Mathematical Tables* [1] was the culmination of a quarter century of NBS work on core mathematical tools. Evaluating commonly occurring mathematical functions has been a fundamental need as long as mathematics has been applied to the solution of practical problems. In 1938, NBS initiated its Mathematical Tables Project to satisfy the increasing demand for extensive and accurate tables of functions [2]. Located in New York and administered by the Works Projects Administration, the project employed not only mathematicians, but also a large number of additional staff who carried out hand computations necessary to produce tables. From 1938 until 1946, 37 volumes of the NBS Math Tables Series were issued, containing tables of trigonometric functions, the exponential function, natural logarithms, probability functions, and related interpolation formulae. In 1947, the Math Tables Project was moved to Washington to form the Computation Laboratory of the new National Applied Mathematics Laboratories of NBS. Many more tables subsequently were published in the NBS Applied Mathematics Series; the first of these, containing tables of Bessel functions [3], appeared in 1948.

On May 15, 1952, the NBS Applied Mathematics Division convened a Conference on Tables. Milton Abramowitz of NBS, who had been a member of the technical planning staff for the Math Tables Project, described preliminary plans for a compendium of mathematical tables and related material. Abramowitz indicated that the Bureau was in need of both technical advice and financial support to carry out the project. With the support of the National Science Foundation (NSF), a two-day Conference on Tables was held at the Massachusetts Institute of Technology on September 15-16, 1954, to discuss the prospects for such an undertaking. Twenty-eight persons attended, including both table producers and users from the science and engineering community. The report of the conference concluded that

“an outstanding need is for a Handbook of Tables for the Occasional Computer, with tables of usually encountered functions and a set of formulas and tables for interpolation and other techniques useful to the occasional computer.”

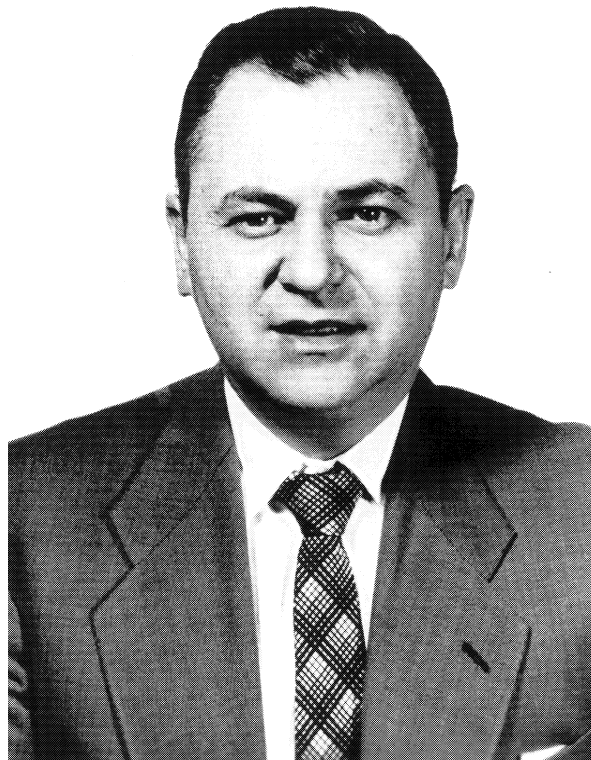

Fig. 1. Portrait of Milton Abramowitz.

(Note that here the term computer refers to a person performing a calculation by hand.) The report recommended that NBS manage the production of the *Handbook* and that NSF provide financial assistance. The conference elected the following committee to carry out its recommendations: P.M. Morse (Chair), M. Abramowitz, J.H. Curtiss, R.W. Hamming, D. H. Lehmer, C.B. Tompkins, and J.W. Tukey. The committee was successful in persuading both NBS and NSF to support the project, and it began officially in December of 1956.

The Mathematics Division of the National Research Council also had an interest in mathematical tables. Since 1943, they had been publishing a quarterly journal entitled *Mathematical Tables and Other Aids to Computation* (today known as *Mathematics of Computation*). To provide technical assistance to NBS, as well as independent oversight for NSF, the NRC established a Committee on Revision of Mathematical Tables. Its members were P. M. Morse (Chair), A. Erdélyi, M. C.

Gray, N. C. Metropolis, J. B. Rosser, H. C. Thacher, Jr., John Todd, C. B. Tompkins, and J. W. Tukey. This group of luminaries in the fields of applied mathematics and physics provided guidance to NBS throughout the project to produce the *Handbook*.

Milton Abramowitz, who was then Chief of the Computation Laboratory of the NBS Applied Mathematics Division, led the project. Abramowitz was born in Brooklyn, NY, in 1915. He received a B. A. from Brooklyn College in 1937 and an M. A. in 1940. He joined the NBS Math Tables Project in 1938 and in 1948 received a Ph.D. in Mathematics from New York University. Abramowitz' dedication, enthusiasm, and boundless energy led to substantial progress in the project during its first year. The proposed outline for the *Handbook* called for a series of some 20 chapters, each with a separate author. Authors were drawn from NBS staff and guest researchers, as well as external researchers working under contract. Most chapters would focus on a particular class of functions, providing formulas, graphs, and tables. Listed formulas would include differential equations, definite and indefinite integrals, inequalities, recurrence relations, power series, asymptotic expansions, and polynomial and rational approximations. Material would be carefully selected in order to provide information most important in applications, especially in physics. Consequently, the higher mathematical functions, such as Bessel functions, hypergeometric functions, and elliptic functions, would form the core of the work. Additional chapters would provide background on interpolation in tables and related numerical methods for differentiation and quadrature.

Philip J. Davis of NBS first prepared Chapter 6, on the gamma and related functions, to serve as a model for other authors. This chapter portrayed the telegraphic style that is a hallmark of the *Handbook*, i.e., the material is displayed with a minimum of textual description. In the course of developing his chapter, Davis became interested in the history of the topic. This led to a historical profile published in 1959 [4], which won the prestigious Chauvenet Prize for distinguished mathematical exposition from the Mathematical Association of America.

The *Handbook* project occurred during the period when general-purpose electronic computing machinery was first coming into use in government research laboratories. (Early computer development of SEAC at NBS is described elsewhere in this volume.) Nevertheless, most of the tables in the *Handbook* were generated by hand on desk calculators. However, even at that time it was clear to the developers of the *Handbook*

that the need for tables themselves would eventually be superseded by computer programs which could evaluate functions for specified arguments on demand.

By the summer of 1958, substantial work had been completed on the project. Twelve chapters had been completed, and the remaining ones were well underway. The project experienced a shocking setback one weekend in July 1958 when Abramowitz suffered a heart attack and died. Irene Stegun, who was Assistant Chief of the Computation Laboratory, took over management of the project. Stegun, who was born in Yonkers, NY in 1919, had received an M. A. from Columbia University in 1941, and joined NBS in 1943. The exacting work of assembling the many chapters, checking tables and formulas, and preparing the work for printing took much longer than anticipated. Nevertheless, the *Handbook of Mathematical Functions, with Formulas, Graphs, and Mathematical Tables* was finally issued as Applied Mathematics Series Number 55 in June 1964 [1]. The volume, which is still in print at the U.S. Government Printing Office and stocked by many bookstores and online booksellers, is 1046 pages in length. The chapters and authors are as follows.

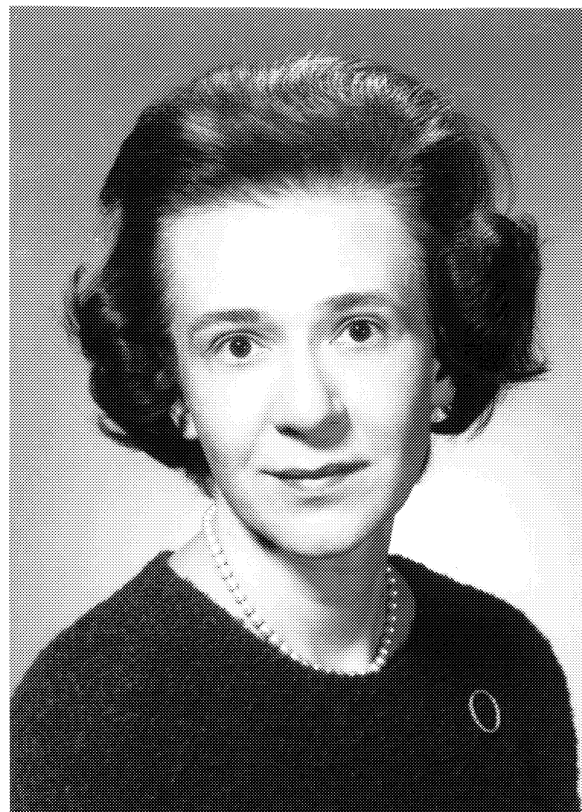

Fig. 2. Portrait of Irene Stegun.

1. *Mathematical Constants*, D. S. Liepman.
2. *Physical Constants and Conversion Factors*, A. G. McNish.
3. *Elementary Analytical Methods*, M. Abramowitz.
4. *Elementary Transcendental Functions*, R. Zucker.
5. *Exponential Integral and Related Functions*, W. Gautschi (American University) and William F. Cahill.
6. *Gamma Function and Related Functions*, P. J. Davis.
7. *Error Function and Fresnel Integrals*, W. Gautschi (American University).
8. *Legendre Functions*, I. A. Stegun.
9. *Bessel Functions of Integer Order*, F. W. J. Olver.
10. *Bessel Functions of Fractional Order*, H. A. Antosiewicz.
11. *Integrals of Bessel Functions*, Y. L. Luke.
12. *Struve Functions and Related Functions*, M. Abramowitz.
13. *Confluent Hypergeometric Functions*, L. J. Slater (Cambridge University).
14. *Coulomb Wave Functions*, M. Abramowitz.
15. *Hypergeometric Functions*, F. Oberhettinger.
16. *Jacobian Elliptic Functions and Theta Functions*, L. M. Milne-Thomson (University of Arizona).
17. *Elliptic Integrals*, L. M. Milne-Thomson (University of Arizona).
18. *Weierstrass Elliptic and Related Functions*, T. H. Southard.
19. *Parabolic Cylinder Functions*, J. C. P. Miller (Cambridge University).
20. *Mathieu Functions*, G. Blanch (Wright-Patterson Air Force Base).
21. *Spheroidal Wave Functions*, A. N. Lowan (Yeshiva University).
22. *Orthogonal Polynomials*, U. W. Hochstrasser (American University).
23. *Bernoulli and Euler Polynomials—Riemann Zeta Function*, E. V. Haynsworth and K. Goldberg.
24. *Combinatorial Analysis*, K. Goldberg, M. Newman, and E. Haynsworth.
25. *Numerical Interpolation, Differentiation, and Integration*, P. J. Davis and I. Polonsky.
26. *Probability Functions*, M. Zelen and N. C. Severo.
27. *Miscellaneous Functions*, I. A. Stegun.
28. *Scales of Notation*, S. Peavy and A. Schopf (American University).
29. *Laplace Transforms*.

The public reaction to the publication of the *Handbook* was overwhelmingly positive. In a preface to the ninth printing in November 1970, NBS Director Lewis Branscomb wrote

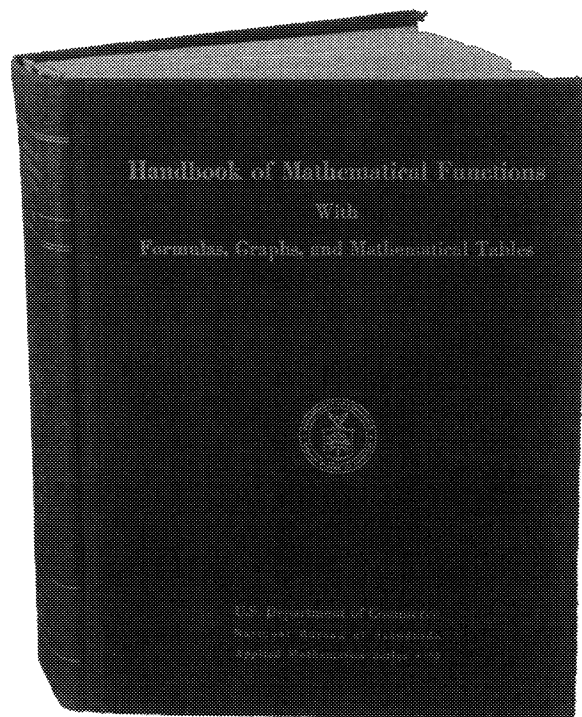

Fig. 3. Photograph of *Handbook*.

“The enthusiastic reception accorded the ‘*Handbook of Mathematical Functions*’ is little short of unprecedented in the long history of mathematical tables that began when John Napier published his tables of logarithms in 1614. Only four and one-half years after the first copy came from the press in 1964, Myron Tribus, the Assistant Secretary for Commerce for Science and Technology, presented the 100,000th copy of the *Handbook* to Lee A. DuBridge, then Science Advisor to the President.”

The *Handbook* has had enormous impact on science and engineering. Likely the most widely distributed NBS/NIST technical publication of all time, the government edition has never gone out of print, and it has appeared as a Dover reprint since 1965. It has been reprinted (in all or part) by other publishers, such as Moscow Nauka, Verlag Harri Deutsch, and Wiley Interscience. Government sales exceed 150,000 copies, with commercial sales estimated at three to six times this number. The *Handbook*’s citation record is also remarkable. More than 23,000 citations have been logged by Science Citation Index (SCI) since 1973. Remarkably, the number of citations to the *Handbook* continues to grow, not only in absolute numbers, but also as a

fraction of the total number of citations made in the sciences and engineering. During the mid-1990s, for example, about once every 1.5 hours of each working day some author, somewhere, made sufficient use of the *Handbook* to list it as a reference. The success of the *Handbook* was due to several factors. It collected in one place, and in a well-organized way, the most important information needed to make use of mathematical functions in practical applications. It served to standardize notations and normalizations for the special functions of applied mathematics, thus easing the communication of scientific results. In 1965, Irene Stegun was awarded a Gold Medal from the Department of Commerce for her efforts in completing the project.

A number of difficult mathematical problems that emerged in the course of developing the *Handbook* engaged researchers in the NBS Applied Mathematics Division for a number of years after its publication. Two of these are especially noteworthy, the first having to do with stability of computations and the second with precision.

Mathematical functions often satisfy recurrence relations (difference equations) that have great potential for use in computations. However, if used improperly, recurrence relations can quickly lead to ruinous errors. This phenomenon, known as instability, has tripped up many a computation that appeared, superficially, to be straightforward. The errors are the result of subtle interactions in the set of all possible solutions of the difference equation. Frank Olver, who wrote the *Handbook's* chapter on Bessel functions of integer order, studied this problem in great detail. In a paper published in 1967 [5], Olver provided the first (and only) stable algorithm for computing all types of solutions of a difference equation with three different kinds of behavior: strongly growing, strongly decaying, and showing moderate growth or decay. Part of the impact of this work is reflected today in the existence of robust software for higher mathematical functions. Olver worked on such topics in the Mathematical Analysis Division of NBS, and this work provided the foundation for his very influential later book on asymptotic analysis

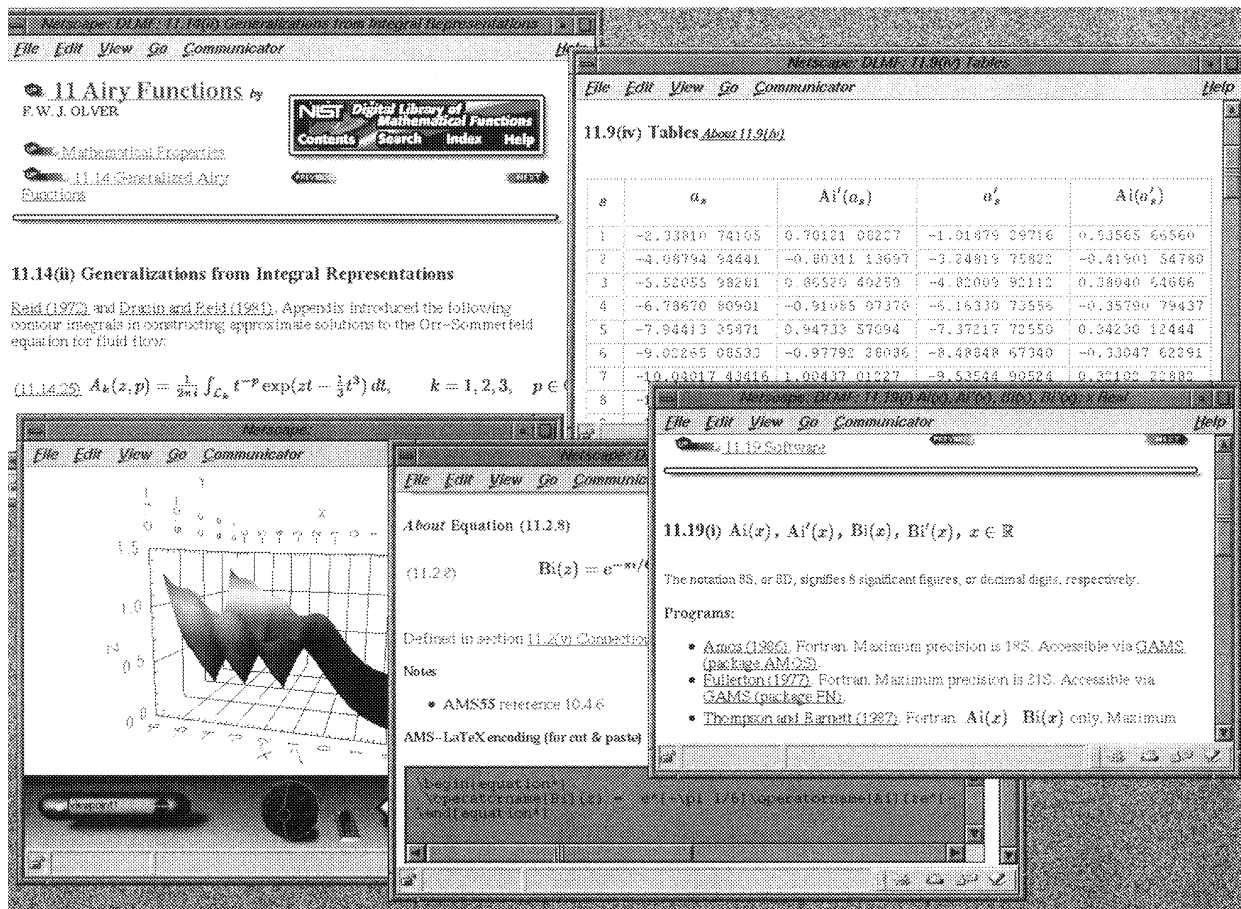

Fig. 4. Screen shot of the NIST Digital Library of Mathematical Functions.

and special functions [6]. This book has been cited more than 800 times, according to SCI.

Another important problem in mathematical computation is the catastrophic loss of significance caused by the fixed length requirement for numbers stored in computer memory. Morris Newman, who co-authored the *Handbook's* chapter on combinatorial analysis, sought to remedy this situation. He proposed storing numbers in a computer as integers and performing operations on them exactly. This contrasts with the standard approach in which rounding errors accumulate with each arithmetic operation. Newman's approach had its roots in classical number theory: First perform the computations modulo a selected set of small prime numbers, where the number of primes required is determined by the problem. These computations furnish a number of local solutions, done using computer numbers represented in the normal way. At the end, only one multilength computation is required to construct the global solution (the exact answer) by means of the Chinese Remainder Theorem. This technique was first described in a paper by Newman in 1967 [7]; it was employed with great success in computing and checking the tables in Chapter 24 of the *Handbook*. Today, this technique remains a standard method by which exact computations are performed. Newman's research on this and other topics, performed at NBS, formed the basis for his 1972 book [8], which quickly became a standard reference in the applications of number theory to computation.

Research into the functions of applied mathematics has continued actively in the 36 years since the *Handbook* appeared. New functions have emerged in importance, and new properties of well-known functions have been discovered. In spite of the fact that sophisticated numerical methods have been embodied in well-

designed commercial software for many functions, there continues to be a need for a compendium of information on the properties of mathematical functions. To address this need, NIST is currently developing a successor to the *Handbook* to be known as the *Digital Library of Mathematical Functions (DLMF)* [9]. Based upon a completely new survey of the literature, the DLMF will provide reference data in the style of the *Handbook* in a freely available online format, with sophisticated mathematical search facilities and interactive three-dimensional graphics.

Prepared by Ronald F. Boisvert and Daniel W. Lozier.

Bibliography

- [1] Milton Abramowitz and Irene A. Stegun, eds., *Handbook of Mathematical Functions With Formulas, Graphs, and Mathematical Tables*, NBS Applied Mathematics Series 55, National Bureau of Standards, Washington, DC (1964).
- [2] Arnold N. Lowan, The Computation Laboratory of the National Bureau of Standards, *Scripta Math.* **15**, 33-63 (1949).
- [3] *Tables of the Bessel Functions $Y_0(x)$, $Y_1(x)$, $K_0(x)$, $K_1(x)$ $0 \leq x \leq 1$* , NBS Applied Mathematics Series 1, National Bureau of Standards, Washington, DC (1948).
- [4] Philip J. Davis, Leonhard Euler's Integral: A Historical Profile of the Gamma Function, *Am. Math. Monthly* **66**, 849-869 (1959).
- [5] F. W. J. Olver, Numerical Solution of Second-Order Linear Difference Equations, *J. Res. Natl. Bur. Stand.* **71B**, 111-129 (1967).
- [6] F. W. J. Olver, *Asymptotics and Special Functions*, Academic Press, New York (1974). Reprinted by A. K. Peters, Wellesley, MA (1997).
- [7] Morris Newman, Solving Equations Exactly, *J. Res. Natl. Bur. Stand.* **71B**, 171-179 (1967).
- [8] Morris Newman, *Integral Matrices*, Academic Press, New York (1972).
- [9] D. Lozier, F. W. J. Olver, C. Clark, and R. Boisvert (eds.), *Digital Library of Mathematical Functions*, (<http://dlmf.nist.gov>) National Institute of Standards and Technology, .

Paths, Trees, and Flowers

“Jack Edmonds has been one of the creators of the field of combinatorial optimization and polyhedral combinatorics. His 1965 paper ‘Paths, Trees, and Flowers’ [1] was one of the first papers to suggest the possibility of establishing a mathematical theory of efficient combinatorial algorithms . . .” [from the award citation of the 1985 John von Neumann Theory Prize, awarded annually since 1975 by the Institute for Operations Research and the Management Sciences].

In 1962, the Chinese mathematician Mei-Ko Kwan proposed a method that could be used to minimize the lengths of routes walked by mail carriers. Much earlier, in 1736, the eminent Swiss mathematician Leonhard Euler, who had elevated calculus to unprecedented heights, had investigated whether there existed a walk across all seven bridges that connected two islands in the river Pregel with the rest of the city of Königsberg on the adjacent shores, a walk that would cross each bridge exactly once.

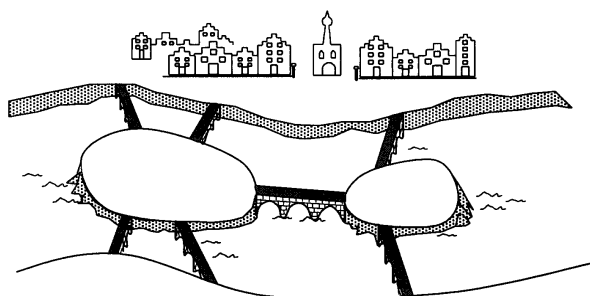

Fig. 1. The bridges of Königsberg.

Different as they may sound, these two inquiries have much in common. They both admit schematic representations based on the concept of *graphs*. Thus they are problems in *graph theory*, a twentieth century discipline which combines aspects of combinatorics and topology.

Given a set of items called *nodes* and a second set of items called *arcs*, a graph is defined as a relationship between such sets: For each arc, two of the nodes are specified to be *joined* by this arc. The actual, say physical, meaning of such nodes and arcs is not what distinguishes graphs. Only formal relationships count. In particular, the bridges of Königsberg may be consid-

ered as arcs, each joining a pair of the four nodes which correspond to the two islands and the two shores.

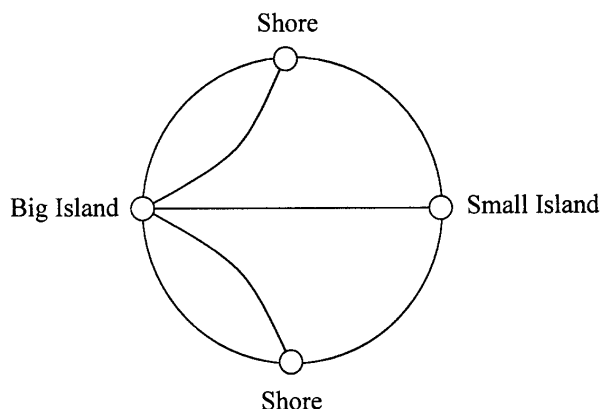

Fig. 2. The graph of the bridges of Königsberg.

The commonality between the two graph-theoretical problem formulations reaches deeper. Given any graph, for one of its nodes, say i_0 , find an arc a_1 that joins node i_0 and another node, say i_1 . One may try to repeat this process and find a second arc a_2 which joins node i_1 to a node i_2 and so on. This process would yield a sequence of nodes—some may be revisited—successive pairs of which are joined by arcs (Fig. 3). The first and the last node in that sequence are then connected by this

“path.”

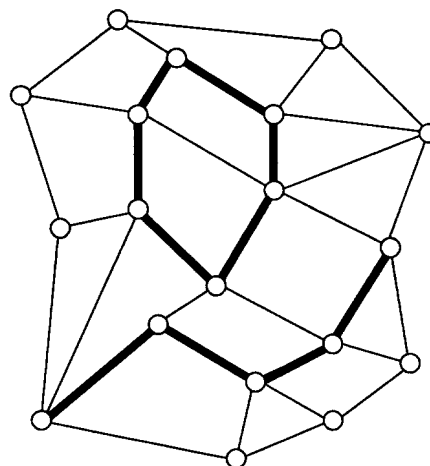

Fig. 3. Open and closed paths in the graph.

(Think of a route along street segments joining intersections.) If each pair of nodes in a graph can be connected by a path, then the whole graph is considered *connected*. A path in a graph is called *closed* if it returns to its starting point (Fig. 3).

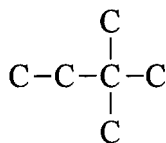
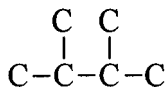
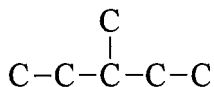
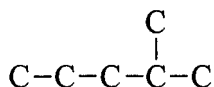
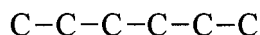

Fig. 4. The carbon graphs of the isomers of C_6H_{14} .

Mei-Ko Kwan's "Chinese Postman Problem," as it is now generally called (since first suggested by Alan Goldman, then of NBS), is to determine, in a given connected graph, a shortest closed path which traverses every arc at least once—delivers mail on every assigned street block. Euler also considers closed paths meeting all arcs, but aims at characterizing all graphs which accommodate an *Euler tour*, a closed path that crosses each arc exactly once. As Euler found, they are precisely those connected graphs in which each node attaches to an even number of arcs, or in other words, every node is of even *degree*. By this result, there can be no Euler tour

over the bridges of Königsberg. Euler's examination typifies the classical combinatorial query: Do certain constructs exist and if so, how many?

The following question also illustrates the flavor of classical combinatorics: how many isomers are there of the hydrocarbon $\text{C}_n\text{H}_{2n+2}$? Each such isomer (Fig. 4) is characterized by the joining patterns of the carbon atoms as nodes and bonds as arcs. The corresponding arrangements, therefore, represent graphs. These graphs have a very special property: For any two of their nodes there exists a unique connecting path without repeat arcs. Such a graph is called a

"tree."

Every isomer defines a tree of carbon atoms whose nodes are of degree four or less. Conversely, every such tree uniquely characterizes an isomer. In graph-theoretical terms, the question is: How many trees with n nodes are there with node degrees not exceeding four? (For $n = 40$, the number is 62,481,801,147,341, as determined by ingenious use of "generating functions.")

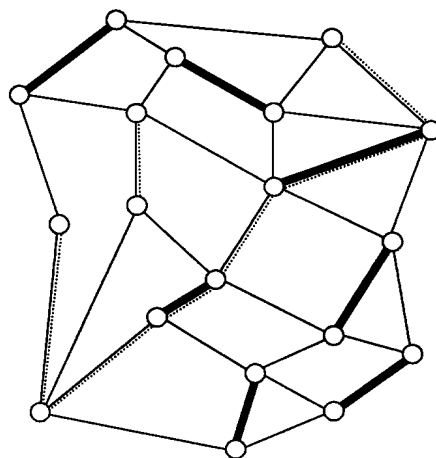

Fig. 5. A matching in a graph; two of the augmenting paths are highlighted by

Here is one more topic in the same vein. A matchmaker has a list of k single men and l single women. Her experience of many years enables her to discern which pairs are compatible. She considers a number of compatible matches that might be arranged simultaneously. How can she be sure that she arrived at the largest possible number of such matches?

A theorem by one of the founders of graph theory, the Hungarian mathematician Dénes König in 1931, suggests an answer to that question. He considered the

graph whose nodes are the matchmaker's clients and whose arcs join the compatible pairs, leading to the graph-theoretical concept of *matching*. A matching in a graph is any subset of its arcs such that no two arcs in the matching meet at a common node (Fig. 5).

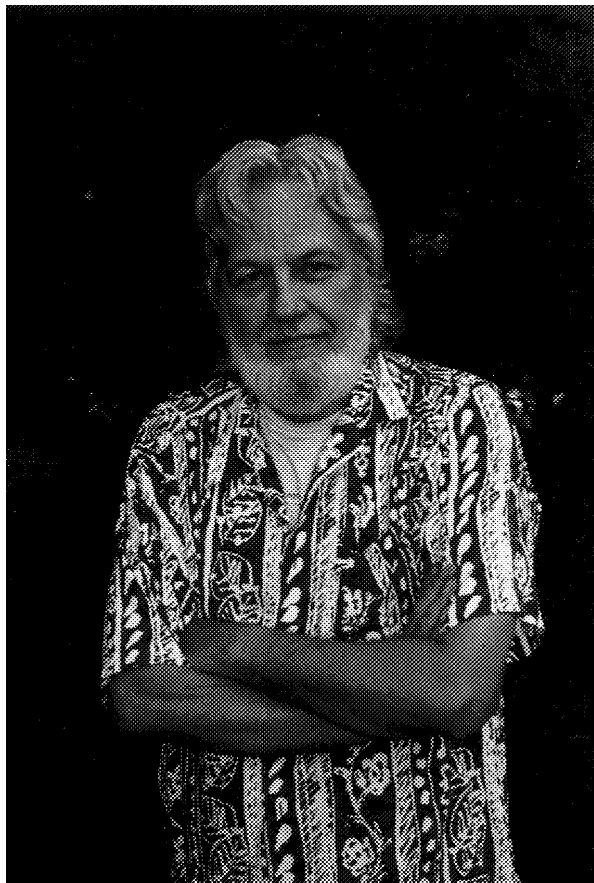

Fig. 6. Jack Edmonds.

Similar concepts are that of a *packing* or *independent set*, namely, a subset of the nodes no two of which are connected by an arc, and of a *cover*, namely, a subset of the nodes that meets every arc.

The matchmaker's graph has the special property that each of its nodes is of one of two kinds, male or female, and every arc connects nodes of different gender. For such a *bipartite* graph, König's theorem states that the number of arcs in a maximum matching equals the number of nodes in a minimum cover. However, this deep result ignores the problem of actually finding a minimum cover in order to prove the optimality of a matching.

Given a particular matching in any graph, an *exposed node* is one that is not met by any arc of the matching.

An *alternating path*, that is, a path whose every other arc is part of the matching, is called *augmenting* if it connects two exposed nodes. Indeed, switching arcs in and out of the matching along an augmenting path results in a new matching with one more arc in it. It is a 1957 theorem by the French mathematician Claude Berge that a larger matching exists not merely if, but also only if, the current matching admits an augmenting path. The classical graph theorist would look at this elegant characterization of maximum matchings and ask: what more needs to be said?

That outlook had been changing during and after World War II. The extensive planning needs, military and civilian, encountered during the war and post-war years now required finding actual solutions to many graph-theoretical and combinatorial problems, but with a new slant: Instead of asking questions about existence or numbers of solutions, there was now a call for "optimal" solutions, crucial in such areas as logistics, traffic and transportation planning, scheduling of jobs, machines, or airline crews, facility location, microchip design, just to name a few. George B. Dantzig's celebrated "Simplex Algorithm" for linear programming was a key achievement of this era.

The Chinese Postman is a case in point. He does not care about how many tours of his street blocks there are to choose from nor whether there are indeed Euler tours. He cares about delivering his mail while walking the shortest possible distance. (Admittedly, mail carriers, Chinese and otherwise, don't really think in terms of the Chinese Postman Problem. But how about garbage collection in a big city?)

And then there were computers, and the expectation that those electronic wizards would handle applied combinatorial optimizations even if faced with the large numbers of variables which typically rendered manual computations impractical.

Enter Jack Edmonds. Edmonds did his undergraduate work at the George Washington University. He recounts—as one of the pioneers featured in the volume *History of Mathematical Programming: A Collection of Personal Reminiscences* [20]—his varied interests and activities of that period. Thus he designed toys and games with expectations of monetary rewards, which unfortunately did not materialize. A stint as a copy boy at the Washington Post found him at the night desk during President Eisenhower's heart attack in 1955. Mathematics, however, survived as his overriding interest. Fascinated by the study of polytopes by the Canadian Mathematician H. S. M. Coxeter, Edmonds' master thesis at the University of Maryland (1959) addressed the problem of embedding graphs into surfaces [6].

In 1959 he joined NBS, became a founding member of Alan Goldman's newly created Operations Research Section in 1961, and was steered towards precisely the endeavor of developing optimization algorithms for problems in graph theory and combinatorics. In particular, he was drawn to two fundamental problems: the "Maximum Packing Problem" and the "Minimum Cover Problem" of determining largest packings and smallest covers, respectively, in a given graph [2].

Edmonds quickly recognized the major challenge of that task, a challenge that he called "the curse of exponentiality." While plainly "finite," many of the known graph-theoretical algorithms required *exponential effort*, or their authors had not detailed their procedures in a way that avoided such exponentiality.

Consider the "Maximum Matching Problem" of finding the largest matching in a given graph. Recall that a matching can be enlarged whenever there is an augmenting path, that is, an alternating path connecting two exposed nodes. As a consequence, there exists an "algorithm" which in a finite number of steps—everything is finite here—determines whether a matching is maximum or shows how to improve it. "All" that's needed is to examine, at each step, the alternating paths originating at exposed nodes. It's just that there are so darn many of them!

In a general framework, computational problems have a natural *size*, for instance, the number of nodes or arcs in a graph. For algorithms, computational effort can then be defined as the number of basic computational steps, such as individual additions or multiplications, and depends on problem size. If computational effort increases as fast or faster than exponentially with problem size, then it is said to require exponential effort. *Polynomial time*, by contrast,—Edmonds used the term *good*—prevails if computational effort is bounded by a power d of problem size n . The notation $O(n^d)$ is used to indicate that level of *complexity*.

Regardless of technological progress, computers are helpless when faced with exponential effort. To wit, the "Traveling Salesman Problem." Here a connected graph is given along with a particular length for each arc. What is wanted is a closed path of least total length that visits every node. The sequence of visits essentially defines such a round trip. Consider, for instance, the 48 state capitals of the contiguous United States and Washington, DC, as nodes of a graph with an arc between any two of them. From a base in Washington, all those capitals are to be visited while minimizing the total distance traveled. Thus there are $48!$ (factorial) round trips in the running. A future supercomputer, spending 1 nanosecond per trip, would require more than 3×10^{44} years to examine all possible trips.

Stressing the integral role of complexity, Edmonds became the leading proponent of a new direction: to develop good algorithms for problems in graph theory and combinatorics (or to identify problems for which such algorithms can be proven not to exist). This has spawned a new area of research that has grown and flourished for four decades and is still going strong. It is not by accident that a graph-theoretical optimization problem, namely, the Traveling Salesman Problem, is now frequently used as a complexity standard, calling a problem *NP-complete* if it requires computational effort equivalent to that of the Traveling Salesman Problem.

In 1961, while attending a summer workshop at the RAND corporation in Santa Monica, California, Jack Edmonds discovered a good algorithm for the Maximum Matching Problem, whose complexity he conservatively pegged at $O(n^4)$.

That algorithm is described in the paper *Paths, Trees, and Flowers* [1]. In its title, the words "paths" and "trees" refer to the standard graph-theoretical concepts. The algorithms augmenting paths are found by a "tree search" combined with a sophisticated process of shrinking certain subgraphs called blossoms into single nodes of a reduced graph. Hence the term

"flowers"

in the title.

Why was it a breakthrough? The answer is that all good graph-theoretical algorithms known at the time addressed "unimodular" problems such as the "Shortest Path" and "Network Flow" problems, the rigorous proof for the latter having been given by Edmonds with collaboration by Richard M. Karp [13]. These are problems that could be formulated as integrality-preserving linear programs, which by themselves did not create good algorithms but indicated the potential for such. Edmonds' matching algorithm was the very first instance of a good algorithm for a problem outside that mold.

In addition, *Paths, Trees, and Flowers* contributed a major theoretical result: a generalization of König's theorem that holds for matchings in all kinds of graphs, not just bipartite ones.

Edmonds also conjectured in this paper that both the Maximum Packing Problem and the Minimum Cover Problem were intrinsically harder than the Maximum Matching Problem. Indeed, both of the former problems were subsequently shown to be NP-complete.

In one of his seminal papers [3-10] published in the *Journal of Research of the National Bureau of Standards*, Edmonds [7] extended his algorithm to find matchings that optimize the sum of given arc weights, and, perhaps more importantly, he laid the foundation

for a polyhedral interpretation of matching theory which was pursued, for instance, in the doctoral thesis by William R. Pulleyblank [15] advised by Edmonds.

Subsequently, Edmonds found other good algorithms, for instance, in his path-breaking research on combinatorial abstractions of matrices, called *matroids* [4, 12, 14-17, 19]. And, last but not least, he and Ellis L. Johnson used the matching paradigm to arrive at a first good algorithm for the Chinese Postman Problem [18].

In 1969, Edmonds accepted a professorship of mathematics at the University of Waterloo, where a list of distinguished doctoral students is testament to his special gift of guiding and motivating young mathematicians. He remains to this day an active and highly influential researcher in the field of graph theory and combinatorics.

Why is it important to identify even a few graph-theoretical and combinatorial problems with good solution algorithms, when there is such a great variety of real-life optimization tasks, most of them defined in a less clear-cut fashion? The utility of good algorithms for idealized problems and their theory is that they suggest generalizations, variations, promising avenues of attack, treatable approximations, iterative applications, and also flag problem formulations best to avoid. In all these roles, Edmonds' matching algorithm has been an indispensable and inspirational part of the toolkit for combinatorial optimization and its multiple applications to modern technology.

Prepared by Christoph Witzgall with help by Ronald Boisvert, Geraldine Cheok, Saul Gass, Alan Goldman, and James Lawrence.

Bibliography

- [1] Jack Edmonds, Paths, Trees, and Flowers, *Canad. J. Math.* **17**, 449-467 (1965).
- [2] Jack Edmonds, Covers and Packings in a Family of Sets, *Bull. Amer. Math. Soc.* **68**, 494-499 (1962).
- [3] Jack Edmonds, Existence of k-Edge Connected Ordinary Graphs with Prescribed Degrees, *J. Res. Natl. Bur. Stand.* **68B**, 73-74 (1964).
- [4] Jack Edmonds, Minimum Partition of a Matroid into Independent Subsets, *J. Res. Natl. Bur. Stand.* **69B**, 67-72 (1965).
- [5] Jack Edmonds, Lehman's Switching Game and a Theorem of Tutte and Nash-Williams, *J. Res. Natl. Bur. Stand.* **69B**, 73-77 (1965).
- [6] Jack Edmonds, On the Surface Duality of Linear Graphs, *J. Res. Natl. Bur. Stand.* **69B**, 121-123 (1965).
- [7] Jack Edmonds, Maximum Matching and a Polyhedron with 0,1-Vertices, *J. Res. Natl. Bur. Stand.* **69B**, 125-130 (1965).
- [8] Jack Edmonds and D. R. Fulkerson, Transversals and Matroid Partition, *J. Res. Natl. Bur. Stand.* **69B**, 147-153 (1965).
- [9] Jack Edmonds, Optimum Branchings, *J. Res. Natl. Bur. Stand.* **71B**, 233-240 (1967).
- [10] Jack Edmonds, Systems of Distinct Representatives and Linear Algebra, *J. Res. Natl. Bur. Stand.* **71B**, 241-245 (1967).
- [11] Jack Edmonds, Matroid Partition, in *Mathematics of the Decision Sciences, Part I*, (Proceedings of the Fifth Summer Seminar on the Mathematics of the Decision Sciences, Stanford University, Stanford, CA, 1967), American Mathematical Society, Providence, RI (1968) pp. 335-345.
- [12] Jack Edmonds, Submodular Functions, Matroids, and Certain Polyhedra, in *Combinatorial Structures and their Applications* (Proceedings of the Calgary International Conference on Combinatorial Structures and their Applications, University of Calgary, Calgary, Alberta, Canada, 1969), Gordon and Breach, New York (1970) pp. 69-81.
- [13] Jack Edmonds and Richard M. Karp, Theoretical Improvements in Algorithmic Efficiency for Network Flow Problems, in *Combinatorial Structures and their Applications* (Proceedings of the Calgary International Conference on Combinatorial Structures and their Applications, University of Calgary, Calgary, Alberta, Canada, 1969), Gordon and Breach, New York (1970) pp. 93-96.
- [14] Jack Edmonds, Matroids and the Greedy Algorithm, *Math. Programming* **1**, 127-136 (1971).
- [15] W. Pulleyblank and Jack Edmonds, Facets of 1-Matching Polyhedra, in *Hypergraph Seminar* (Proceedings of the First Working Seminar on Hypergraphs, Ohio State Univ., Columbus, Ohio, 1972) Lecture Notes in Mathematics Vol. 411, Springer-Verlag, Berlin (1974) pp. 214-242.
- [16] Jack Edmonds, Edge-Disjoint Branchings, in *Combinatorial Algorithms* (Courant Computer Science Symposium 9, Naval Postgraduate School, Monterey, CA, 1972), Algorithmics Press, New York (1973) pp. 91-96.
- [17] Peyton Young and Jack Edmonds, Matroid Designs, *J. Res. Natl. Bur. Stand.* **77B**, 15-44 (1973).
- [18] Jack Edmonds and Ellis L. Johnson, Matching, Euler Tours, and the Chinese Postman, *Math. Programming* **5**, 88-124 (1973).
- [19] Jack Edmonds, Matroid Intersection, in *Discrete Optimization I* (Proceedings of the Advanced Research Institute on Discrete Optimization and Systems Applications, Alberta, Canada, 1977); *Ann. Discrete Math.* **4**, 39-49 (1979).
- [20] Jan Karel Lenstra, Alexander H. G. Rinnooy Kan, Alexander Schrijver, *History of Mathematical Programming, A Collection of Personal Reminiscences*, North-Holland, Amsterdam (1991).

Concepts, Terminology, and Notation for Optical Modulation

In the early 1960s, the National Bureau of Standards aided the photographic and printing industries by conducting research on precise measurement of optical transmission and reflection density, providing physical standards to calibrate instruments, and writing national and international documentary standards on optical density measurement. Optical density is a logarithmic measure of the darkness of a photograph or printed image. Although the science was hardly new, it suffered from loose concepts and imprecise terminology. The same problems were encountered in photometry, radiometry, colorimetry, and spectrometry. This publication [1] represented a major step forward in removing the confusion and promoting the use of precise concepts in optical measurements.

Physics textbooks defined “reflectance” as the ratio of the amount of light reflected from a surface to the amount of incident light. Workers who said they were measuring reflectance actually measured the ratio of the amount of reflected light to the amount of light reflected from a standard diffuse white surface. They generally regarded the measurement of the light reflected from the white surface as merely a convenient way of measuring the incident light. There was no generally accepted terminology to distinguish these two kinds of measurements. The concepts thus were blurred.

The degree of confusion may be illustrated by an example. Light incident on white paper is diffusely reflected in all directions, only a minute fraction being reflected to the pupil of the eye. The ratio of the amount reflected *in that direction* to the amount incident is a very small number, perhaps under 0.001. On the other hand, the ratio of the amount *reflected in that direction* to the amount reflected *in the same direction* from a standard diffuse white surface may be as much as 0.9. These are two different concepts—two different physical quantities, with vastly different numerical values. Such considerations led to a thorough analysis of the basic concepts and terminology in this field. The term “reflectance” was retained for the concept defined in textbooks. The measurement relative to a white standard was called “reflectance factor.” That term is now used internationally in photography, printing, and color science.

Considerations of transmission measurements had even more important consequences. The textbook definition of “transmittance” is the ratio of the amount of transmitted light to the amount of incident light. The most important applications of transmission are motion-picture projection, slide projection, projection printing (enlarging), and the viewing of x rays and other transparencies on viewing boxes. A projector forms an image on a screen because the film absorbs or scatters some light, so the illumination at each point is some fraction of what it would be without the film. It might appear that one would need no more than the concept “transmittance” to quantify this process. However, some projectors were made to view microfilm images that scattered light. The light source was moved to one side, so the light beam passed through the film gate but was not directed toward the projection lens. With no film in the gate, the screen was dark. When film was inserted, some light was scattered in the direction of the projection lens and the screen became brighter. In *Concepts, Terminology, and Notation* McCamy defined “transmittance factor” as the ratio of the screen luminance with the film in place to the screen luminance without film. The concept called “transmittance factor” had not been previously differentiated from “transmittance.” In the projector just described, the transmittance factor would be much greater than one. By definition, transmittance cannot be greater than one. “Transmittance” and “transmittance factor” are different concepts—two different physical quantities, with different numerical values.

There was no generally accepted collective term for ratios such as those describing reflection, transmission, or some combination of them, so the general term “modulation” was introduced, based on the idea that objects modulate the flow of light. The combination of light source and optics directing light to a specimen was called an “illuminator” or “irradiator” and the optical system collecting and evaluating the light reflected or transmitted in a specified direction was called a “receiver.” Light flowing from an illuminator to a specimen was called “influx” and that evaluated by the receiver was called “efflux.” A guiding principle was that the physical quantity measured was a function of the

ratios measured *and* of the geometrical and spectral specifications of the illuminator and receiver. A well-known mathematical notation signifying a functional relationship was extended and formalized to provide a compact notation describing the geometrical and spectral conditions for such measurements.

Perhaps the most important contribution of this paper was the adoption of the fundamental “principle of simulation”: To measure optical modulation, the geometrical and spectral conditions of measurement must simulate the geometrical and spectral conditions for the use of the modulation. Before this analysis, the standard method of measuring the optical density of a film was to measure the amount of light entering the entrance port of an integrating sphere and then measure the amount entering the sphere with the film covering the entrance port. This method assured purists that all the transmitted light would be measured. NBS provided precise calibrations by this method, relating the optical modulation to the inverse-square law of illumination. In practical densitometers the bulky integrating sphere was replaced with a piece of diffusing opal glass. At low values of density, it was impossible to correlate the standard sphere density with opal-glass density because there were interreflections between the film and the white opal glass. The principle of simulation demanded an answer to the question: “What is the use of the calibrated standards?” In this case they were used to calibrate densitometers. The physical quantity being calibrated so precisely was not the physical quantity being measured in practical applications. Either the calibration procedure had to be changed or the practical instruments had to be upgraded. Again applying the principle of simulation, it was realized that when a film was used for photographic contact printing there were interreflections between the film and the white printing paper. When films, such as x rays, were viewed on a viewing box, there were interreflections between the film and the diffuse illuminator screen. The practical opal-glass densitometers were measuring exactly the right physical quantity, so the “ideal” standard sphere method was abandoned and the opal-glass method was standardized. The same approach led to the development of the standard method of measuring projection density, using geometry simulating practical projectors. Great accuracy and precision are useless if the basic concept of the quantity to be measured is wrong [1].

During this analysis, McCamy was Chairman of the Densitometry Subcommittee of the American Standards Association, which later became the American National Standards Institute. The subcommittee was a sounding board during the work, so the whole system was readily adopted as a national standard [2]. That national standard was equally endorsed by the

International Organization for Standardization (ISO), in an international standard [3]. The color measurement community recognized the need for a term and readily adopted “reflectance factor,” but the rest of the terminology was only gradually assimilated and the system of notation was eventually standardized by the Committee on Color and Appearance of the American Society for Testing and Materials (ASTM) [4,5]. Further parts of the system are being adopted in the current revision of the International Lighting Vocabulary of the International Commission on Illumination (CIE) [6]. A method of greatly simplifying the geometric notation by reference to conical geometry, introduced in this paper, was called “McCamy’s conical method” and recommended by later authors at NBS/NIST [7]. The paper was reprinted in NBS Special Publication 300, *Precise Measurement and Calibration*, Volume 7, *Radiometry and Photometry* [8] and Volume 10, *Image Optics* [9].

Calvin S. McCamy was born in 1924, received a B.Ch.E. in Chemical Engineering and an M.S. in Physics at the University of Minnesota. He taught there

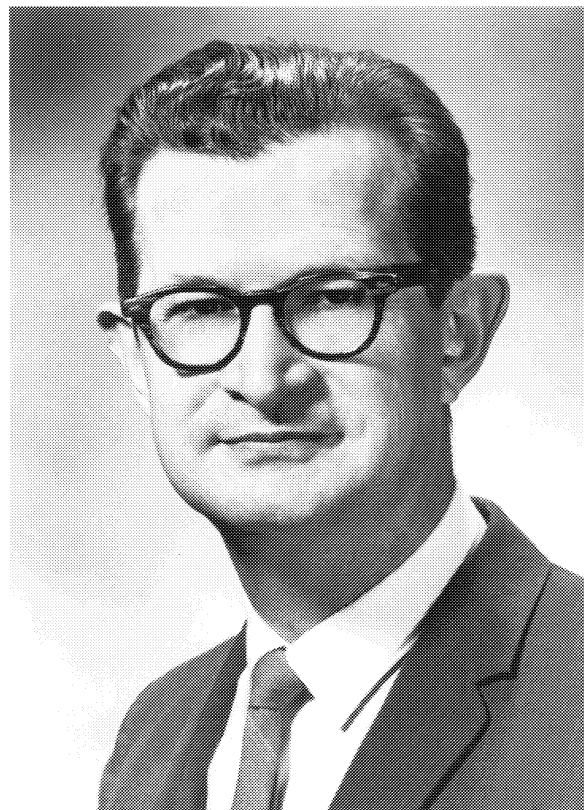

Fig. 1. Calvin S. McCamy at about the time *Concepts, Terminology, and Notation for Optical Modulation* was published.

and at Clemson University and then joined the Fire Research Section of NBS (1958-1964) and subsequently served as Chief of the Photographic Research Section (1958-1964) and Chief of the Image Optics and Photography Section (1964-1970).

In the Photographic Research Section and later the Image Optics and Photography Section, he designed a nomograph to compute the color filter required to take well-balanced colored pictures with a given film and illumination [11]. It was made available on a single sheet from the U.S. Government Printing Office or NBS and was very popular with amateur and professional photographers. It was the subject of many feature articles in popular and professional photographic magazines and became a common feature of color filter catalogs.

When demonstrations by Edwin Land led to widespread speculation that cheaper and better color television could be possible by using two primary colors rather than three, McCamy demonstrated to the Federal Communications Commission that a two-color system was not acceptable. That lecture-demonstration, by means of three projectors, allowed people to witness many visual phenomena. It generated such widespread interest that he was invited to present it fifty times at NBS, major universities, major industrial research laboratories, and scientific society meetings in 1959-1961 [12]. Among other phenomena, he demonstrated that under certain conditions, people perceive colors in black-and-white images. He was invited to repeat that lecture-demonstration forty years later, in February 2000 [13].

Photographic wedges are widely used in photographic science. The wedge may be straight, the density varying linearly with length, or it may be circular, the density varying linearly with rotational angle. Since density is the logarithm of the reciprocal of transmittance, the transmittance varies logarithmically. When the density is gradually changing and is measured over a finite area, it is difficult to know where on the wedge the actual density value is measured. Some finite area is required for measurement. NBS could measure uniform areas precisely, but wedges could not be calibrated because the required theoretical relationships were unknown. McCamy derived the mathematical relationship between the measured density and the location to which it may be assigned, for a rectangular aperture on a straight wedge, a circular aperture on a straight wedge, a sector aperture on a circular wedge, and a circular aperture on a circular wedge [14]. The last case was commonly encountered and, for that case, the mathematical derivation was remarkably complex.

McCamy also designed the resolution target used internationally to test microfilm cameras, and his laboratory made as many as 25,000 per year as standard

reference materials for the industry. He designed and provided other test targets to calibrate instruments used to measure the image structure characteristics of optical and photographic systems. He developed a laboratory camera to measure how much information a photographic film or plate could record on a given area. Scientists involved in manufacturing electronic components came to the Bureau to study the camera, and the general features of it came into widespread use in the production of tiny electronic components. McCamy derived a formula to compute the information storage capacity of a photographic system, in bits per square millimeter, from the measured resolving power [15]. All these activities supported the development and utilization of the U.S. satellite reconnaissance system, which was highly classified during the cold war.

When it was discovered that the vast stores of federal and state government records on microfilm were developing blemishes that might destroy vital archival information, McCamy mustered the support of many government agencies and many private interests to conduct a wide-ranging investigation. His laboratory discovered the cause of the blemishes. The microfilms were stored in cardboard boxes and the aging cardboard emitted minute amounts of hydrogen peroxide, which attacked the film. The task was difficult because the concentration of peroxide was less than 10^{-9} mol/L and the molecules were so labile that they were dissipated on passing through two centimeters of air [16-19].

As Vice President for Research of the Macbeth Division of the Kollmorgen Corporation in 1970-1990, after leaving NBS, McCamy continued research on optical design, precise transmission measurements, color measurement, optical filter design, simulation of daylight for color inspection, geometric attributes of appearance, densitometry in photography and color printing, color order systems, color standards, and related mathematics. He substantially improved the classical absolute method of photometry based on the inverse-square law of illumination, and he designed the Macbeth ColorChecker Color Rendition Chart™, which is used internationally to evaluate color-imaging systems. At the request of Congress in 1978, he analyzed all known photographs and x rays related to the assassination of President Kennedy and testified before the House Select Committee on Assassinations. His method of analyzing images of long firearms is used routinely by the U.S. Federal Bureau of Investigation. He continued to be active in national and international standardization of photography, color printing, and color science, chairing committees of the American National Standards Institute, the American Society for Testing and Materials, the International Commission on Illumination (CIE), and the International Organization

for Standardization (ISO). He wrote the spectral specifications for optical character recognition for the banking industry and the Universal Product Code for the grocery and other retail industries.

He is on the Advisory Board of the Munsell Color Science Laboratory at the Rochester Institute of Technology and was Adjunct Professor at Rensselaer Polytechnic Institute, President of the Kollmorgen Foundation, and Trustee of the Munsell Foundation. He was elected fellow of the Optical Society of America, Society of Photographic Scientists and Engineers, Royal Photographic Society of Great Britain, Society of Motion Picture and Television Engineers, and the Washington Academy of Sciences and has been honored for his lectures. He received the 1997 Bruning Award of the Federation of Societies for Coatings Technology and the 1999 Godlove Award of the Inter-Society Color Council.

Prepared by Calvin S. McCamy.

Bibliography

- [1] C. S. McCamy, Concepts, Terminology, and Notation for Optical Modulation, *Photogr. Sci. Eng.* **10**, 314-325 (1966).
- [2] *Photography—Terms, Symbols, and Notations—Density Measurement*, ANSI PH2.16—1984 (R1990), American National Standards Institute, New York.
- [3] *Photography—Terms, Symbols, and Notations—Density measurements*, ANSI/ISO 5/1—1984, International Organization for Standardization (ISO), Geneva, Switzerland.
- [4] *Standard Terminology of Appearance*, ASTM E 284-98a, American Society for Testing and Materials (ASTM), West Conshohocken, PA.
- [5] *Standard Practice for Specifying the Geometry of Observations and Measurements to Characterize the Appearance of Materials*, ASTM E 1767-95, American Society for Testing and Materials (ASTM), West Conshohocken, PA.
- [6] *International Lighting Vocabulary (E) (F) (G) (R)*, CIE Document No. 17.4 (1987), International Commission on Illumination (CIE), Vienna, Austria.
- [7] F. E. Nicodemus, J. C. Richmond, J. J. Hsia, I. W. Ginsberg, and T. Limperis, *Geometrical Considerations and Nomenclature for Reflectance*, NBS Monograph 160, National Bureau of Standards, Washington, DC (1977).
- [8] H. K. Hammond III and H. L. Mason (eds.), *Precise Measurement and Calibration*, Volume 7, *Radiometry and Photometry*, NBS Special Publication 300, National Bureau of Standards, Washington, DC (1971).
- [9] Calvin S. McCamy (ed.), *Precise Measurement and Calibration*, Volume 10, *Image Optics*, NBS Special Publication 300, National Bureau of Standards, Washington, DC (1973).
- [10] C. S. McCamy, A five-band recording spectroradiometer, *J. Res. Natl. Bur. Stand.* **56**, 293-299 (1956).
- [11] C. S. McCamy, A nomograph for selecting light balancing filters for camera exposure of color films, *Photogr. Sci. Eng.* **3**, 302-304 (1959).
- [12] C. S. McCamy, A demonstration of color perception with abridged color-projection systems, *Photogr. Sci. Eng.* **4**, 155-159 (1960); C. S. McCamy, Colors perceived with abridged color projection systems (Abstract), *J. Opt. Soc. Am.* **50**, 510(A) (1960).
- [13] C. S. McCamy, Abridged Color Revisited—or Sleeping Beauty II, invited presentation at the Inter-Society Color Council, 2nd Panchromatic Conference on “Color in Its Surround,” Savannah, GA, February 20, 2000.
- [14] C. S. McCamy, Theory of optical wedges as flux modulators, *J. Opt. Soc. Am.* **66**, 1350-1355 (1976).
- [15] C. S. McCamy, On the information in a microphotograph, *Appl. Opt.* **4**, 405-411 (1965).
- [16] C. S. McCamy, *Inspection of processed photographic record films for aging blemishes*, NBS Handbook 96, National Bureau of Standards, Washington, DC (1964).
- [17] C. S. McCamy, S. R. Wiley, and J. A. Speckman, A survey of blemishes on processed microfilm, *J. Res. Natl. Bur. Stand.* **73A**, 79-99 (1969).
- [18] C. S. McCamy and C.I. Pope, Current research on preservation of archival records on silver-gelatin type microfilm in roll form, *J. Res. Natl. Bur. Stand.* **69A**, 385-395 (1965).
- [19] C. S. McCamy and C. I. Pope, Redox blemishes—their cause and prevention, *J. Microgr.* **3**, 165-170 (1970).

Theory of Light Scattering in Fluids

This review of light scattering theory [1] brought together a range of concepts which had been developed over more than half a century. Light scattering has been used to measure thermal properties of liquids and solids ever since Einstein showed that the intensity of light scattered by density fluctuations is proportional to the isothermal compressibility of the fluid. Density fluctuations, in turn, can be considered to be a sum of pressure fluctuations and entropy fluctuations. Independently, Brillouin and Mandel'shtam realized that the pressure fluctuations are associated with acoustic modes and would shift the frequency of the scattered light by an amount proportional to the speed of sound. In 1935, Landau and Placzek published a short note in which the contribution of the entropy fluctuation component of density fluctuations to the scattering of light was identified and shown to be unshifted in frequency. The intensity ratio of the two components of the scattered light (entropy fluctuation component divided by the pressure fluctuation component) is equal to the ratio of $(C_p - C_v)/C_v$, the specific heat difference divided by the constant volume specific heat. (This has come to be known as the Landau-Placzek ratio.) They also noted that the spectral width of the light scattered by the non-propagating density fluctuations would be proportional to the thermal diffusivity of the fluid.

Prior to the advent of the He-Ne gas laser, it was not possible to exploit these ideas fully because the spectral width of available light sources was larger than the frequency broadening due to the non-propagating fluctuations. It was only possible to estimate sound speed and heat capacity ratios if a great deal of care was taken. This changed when He-Ne lasers became available as light sources that were nearly monochromatic and coherent. Heterodyne and homodyne detection schemes now made it possible examine the structure of scattered light in detail. In short order, light scattering became an active research topic and tool with particular attention paid to scattering near critical points, where the scattering intensity is large. It would not be an understatement to say that the prospect of using a new technique to study dynamics near critical points was exciting.

The theoretical ideas mentioned above were not organized in a form that would be readily accessible to the students entering the field. The necessary theory can be extracted from three of the volumes of the Landau and Lifshitz series, *Statistical Physics*, *Fluid Mechanics*, and

Electrodynamics of Continuous Media, but only if one knows where to look. Thus, a review article putting the pieces together was timely. At the urging of M. S. Green, Chief of the Statistical Physics Section, Raymond Mountain prepared the review article *Spectral Distribution of Scattered Light in a Simple Fluid* [1] that brought these theoretical ideas together. The emphasis of the article was on how the spectra are related to fluid properties. The review also showed how light scattering theory was related to the theory of sound propagation in a liquid. It was an opportunity to put statistical mechanics in contact with experiments. In structuring the article, use was made of the work of I. L. Fabelinskii, S. M. Rytov, and R. Pecora.

The underlying idea in the theory of scattering by fluctuations is that scattering provides an average over the fluctuations in both space and in time. Statistical mechanics provides the theoretical framework needed to relate the observed scattered light to fluid properties, and that is the approach followed in the paper. The result is an explicit formula connecting the intensity and frequency distribution of the scattered light to the thermodynamic and transport properties of the fluid.

This theory of light scattering is phenomenological. It provides the connection between the spectrum of the scattered light and various thermodynamic and transport properties of the fluid. The use of the inherently macroscopic equations of hydrodynamics to describe events on the scale probed by light scattering may seem to be an unjustified extrapolation. It is not for two reasons. First, the fluctuations that lead to light scattering have a size on the order of the wavelength of light, that is micrometers. The distance between near neighbor molecules in a liquid is on the order of tenths of a nanometer, over a thousand times smaller. Second, the time scale of these fluctuations is much longer than the time intervals associated with molecular scattering processes. With these considerations in mind, the use of hydrodynamic fluctuation theory is quite reasonable. This approach would break down for the case of scattering from a gas, where the mean-free-path of a molecule is on the order of the wavelength of light. (Although not part of the review, this has been demonstrated experimentally. Agreement between theory and experiment is recovered when kinetic theory of gases is used in place of hydrodynamics to describe the time evolution of the fluctuations [2].)

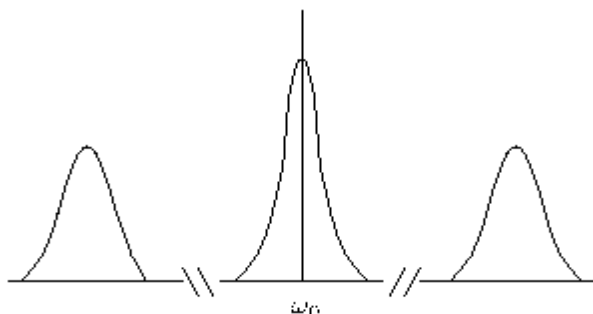

Fig. 1. The spectrum of light scattered by density fluctuations is sketched here. The central component, centered at ω_0 the frequency of the incident light, has a width on the order of MHz. The other components are shifted from the incident frequency by an amount on the order of GHz. Hence, the break indicated on the horizontal axis. The Landau-Placzek ratio is the ratio of the area under the central component to the area under the other two components.

The spectrum of the scattered light consists of a central, unshifted component with a width proportional to the thermal diffusivity and two Brillouin-Mandel'shtam components that are shifted in frequency by an amount proportional to the adiabatic sound speed. The width of the shifted components is proportional to the acoustic attenuation coefficient. If a He-Ne source is used and the scattered light is observed at an angle of 90° from the direction of propagation of the incident light, the widths of these spectral features are on the order of megahertz and the shifts are on the order of gigahertz.

When the fluid is close to the liquid-vapor critical point, the density fluctuations are large enough to make the scattering visible to the naked eye. The fluid takes on a milky color, called critical opalescence. Since critical opalescence was a "hot topic," the review utilized the theory to predict how the scattered light would appear for states close to the critical point of carbon dioxide, a substance for which the relevant thermodynamic and transport property data were available. There followed some speculations on how these predictions would be modified very close to the critical point. (These speculations were later shown to be only crude approximations to the observations since renormalization ideas were not included [3].) Finally, a cautionary note was sounded about carefully characterizing the state of the system being studied. "It is important to keep in mind that *light-scattering experiments are only as good as the PVT data used to specify the thermodynamic state of the scattering system.*"

Since hydrodynamic fluctuation theory is also pertinent to acoustic wave propagation and attenuation, a section discussing the connections between light scattering and sound propagation was included. In both

situations, the same dispersion relation is used. The difference is that in light scattering the wavelength is fixed and the frequency varies, while in acoustic wave propagation the frequency is held fixed and the wavelength is allowed to vary. The lesson is that the interpretations of the two types of measurements are different, a point that had not been widely appreciated.

The article provides an introduction to the theory that can be readily understood by most physical scientists. The review was well received and was widely referenced. It has been reprinted in collections. In 1980 it was highlighted in Science Citation Index as a "Citation Classic," meaning that it had been cited more than 250 times since the article was published. Many of the features of the review had been incorporated into books by then [2,4].

Some of the theory expounded in the review did not conform to the experimental results on the scattering of light in molecular liquids. In many cases, the ratio of the intensity of the central component to the Brillouin components (the Landau-Placzek ratio) exceeded the specific heat ratio for the liquid. This experimental finding indicated that the spectrum of the scattered light contained additional features. This led Mountain to develop a hydrodynamic fluctuation theory for the spectrum of the scattered light that included internal molecular degrees of freedom, such as vibrational states. This theory predicts that some of the intensity associated with the sound modes is transferred to an unshifted, but quite broad, spectral feature which is separate from the entropy fluctuation component, which has a spectral width proportional to the thermal diffusion coefficient. The existence of this component was demonstrated experimentally at the same time the short note describing the feature appeared [5-7]. This feature is sometimes called the "Mountain peak" although it is a fairly weak, broad feature in the spectrum of many liquids. The story is different for polymers and for strongly supercooled liquids, where there are many internal degrees of freedom that have a major influence on the density fluctuations, so that the additional feature is large.

The same sort of theory developed for one-component liquids has been developed for mixtures. In that case, the dominant fluctuations that lead to scattering are composition fluctuations. The spectrum of these fluctuations are more complex due to the additional variable (composition) in the problem [8-10].

Raymond D. Mountain came to NBS as a Post-doctoral Research Fellow in 1963 and became a regular staff member of the Heat Division in 1965. The review article was prepared while he was a postdoc. He became chief of the Statistical Physics Section in 1968 when M. S. Green left NBS for Temple University, and served

in this position until 1982. In 1986 he was named a NIST Fellow. He received the Department of Commerce Gold Medal in 1983 for his research on the liquid state. In 1974 he was named a Guggenheim Fellow and spent a year at the Institute for Theoretical Physics in Utrecht, The Netherlands.

Prepared by Raymond D. Mountain.

Bibliography

- [1] R. D. Mountain, Spectral Distribution of Scattered Light in a Simple Fluid, *Rev. Mod. Phys.* **38**, 205-214 (1966).
- [2] J.-P. Boon and S. Yip, *Molecular Hydrodynamics*, McGraw Hill, New York (1980).
- [3] P. C. Hohenberg and B. I. Halperin, Theory of dynamic critical phenomena, *Rev. Mod. Phys.* **49**, 435-479 (1977).
- [4] B. J. Berne and R. Pecora, *Dynamic Light Scattering: With Applications to Chemistry, Biology, and Physics*, John Wiley and Sons, New York (1976).
- [5] R. D. Mountain, Interpretation of Brillouin Spectra, *J. Chem. Phys.* **44**, 832-833 (1966).
- [6] R. D. Mountain, Thermal relaxation and Brillouin scattering in liquids, *J. Res. Natl. Bur. Stand.* **70A**, 207-220 (1966).
- [7] R. D. Mountain, Density fluctuations in fluids having an internal degree of freedom, *J. Res. Natl. Bur. Stand.* **72A**, 95-100 (1968).
- [8] R. D. Mountain, Spectral structure of critical opalescence: Binary mixture, *J. Res. Natl. Bur. Stand.* **69A**, 523-525 (1965).
- [9] R. D. Mountain and J. M. Deutch, Light scattering from binary solutions, *J. Chem. Phys.* **50**, 1103-1108 (1969).
- [10] L. Fishman and R. D. Mountain, Activity coefficients of solutions from the intensity ratio of Rayleigh to Brillouin scattering, *J. Phys. Chem.* **74**, 2178-2182 (1970).

Scaling Analysis of Thermodynamic Properties in the Critical Region of Fluids

This paper [1] was an outgrowth of the renewed interest, beginning in the early 1960s, in the problem of how to describe the critical point, the limit point of phase transitions. This interest came about in part from new abilities to make light scattering and neutron scattering measurements and in part from theoretical work that pointed toward universal property behavior at and near critical points. The universal behavior was thought to be independent of the substance and of the type of phase transition. A 1965 conference held at NBS [2] brought this work into focus and set the stage for the developments that followed. The conference stimulated much new research, including important contributions from Anneke Sengers and Mel Green of NBS.

The prospect of a unifying principle, universality of critical point behavior, excited the interest of many scientists. The “classical theory” of the critical point makes the strong assumption that the free energy of the fluid is an analytic function of the density and temperature at the critical point. (Fluid terminology will be used here, keeping in mind that the concepts are equally applicable to other critical points, such as the Curie point of a ferromagnet or the Néel point of an antiferromagnet, with the appropriate change of variable names. For a fluid, the critical point is characterized by a particular value of the density, ρ_c , and of the temperature, T_c . At the critical point, the density of the liquid phase becomes equal to the density of the coexisting vapor phase.) This means that the thermodynamics of the fluid in the critical region can be expressed in terms of a Taylor’s series expansion of the free energy about the critical point in terms of the difference of the temperature and density from the critical temperature and critical density. The classical theory makes predictions that were known (if not always remembered) to be in conflict with experimental results. Soon after the conference it was shown that near the critical point, thermodynamic properties, such as the equation of state, could be described usefully in a scaled form [3,4]. The scaling theory includes the classical theory as a special case, but does not require the free energy to be analytic at the critical point. The units to use are appropriate combinations of the critical temperature, critical density, and critical pressure for a fluid and the analogous variables for magnetic systems. The scaling form has the additional feature that symmetries can

be expressed simply in terms of the scaled, reduced variables.

A very important task involved the critical evaluation of existing data on many different fluids and magnetic systems. This was needed to determine how the universal behavior is reflected in the thermodynamics of the critical point. It is one thing to postulate a form for the equation of state and the chemical potential in terms of scaled variables, and quite another thing to demonstrate that the form is useful over a significant range of the variables. That demonstration is the contribution of this paper [1] and of subsequent companion papers [5,6].

The paper contains an extensive discussion of how thermodynamic properties of a fluid close to the critical point are to be formulated in a proper manner and, at the same time, in a way that permits comparison with experiments. It would be inappropriate to go through the arguments in detail, so only a bare outline will be presented here.

First, the reader is introduced to some power law descriptions of thermodynamic anomalies in the critical region. An example is the coexistence curve, $\Delta\rho = B(-t)^\beta$, where $\Delta\rho = (\rho - \rho_c)/\rho_c$ and $t = (T - T_c)/T_c$. Other power laws describe the critical isotherm, the isothermal compressibility, and the specific heat at constant volume. (The classical theory predicts $\beta = 1/2$, while the experimental value is on the order of 0.32.) Next, a scaled form for the equation of state, as described by Widom and by Griffiths [3,4], is discussed. Thermodynamics is properly formulated in terms of the Helmholtz free energy as a function of the temperature and the volume. The equation of state is then a partial derivative of the free energy, often in terms of the pressure as the volume derivative of the free energy. The chemical potential is seen from the data to reflect the symmetry properties of the critical point better than does the pressure, so the equation of state is described in terms of the chemical potential as the density derivative of the free energy per unit volume.

The form for the coexistence curve suggests the introduction of a scaling variable, $x = t/\Delta\rho^{1/\beta}$, that reflects the properties of the critical region. The next stage of the paper involves casting these ideas into a scaling function, $h(x)$, that allows them to be tested using experimental data.

With these tools in hand, the existing thermodynamic property data for Ar, Xe, CO₂, ⁴He, and water are examined carefully. The scaling formulation is shown to work quite well for the existing data, but the scaling hypothesis is far from being fully verified. An example of the type of fit to experiment is shown in Fig. 1 where data for carbon dioxide are matched to the form for $h(x)$.

A problem identified in the paper was that the range of density and temperature around the critical point over which scaling is applicable could not be decided on the basis of existing data, which stimulated a number of new experiments.

Although not part of this paper, some very interesting comments on how this work evolved are found in a later paper on the problem [7]. Some of the human side of research is revealed in that reference.

A large amount of research has been performed to extend the analysis started in this paper. The task of identifying the domain where scaling is applicable has gone through several phases. The renormalization group approach to critical phenomena has been central to these developments [8]. One result is the formulation

of “practical” free energy surfaces for industrially important fluids that are consistent with the new understanding of the critical region of the fluid [9]. Another result is the development of a “cross-over” theory that connects the scaling formulation with the rest of the thermodynamic space in a continuous way. Finally, a very large amount of experimental work has been carried out with the result that many of the questions left unanswered by this paper now have clear answers.

There are numerous industrial processes where supercritical fluids play a significant role. Only two will be mentioned here.

Supercritical fluids are utilized as solvents in supercritical extraction processes. The density of a supercritical fluid can be varied over a wide range of values by small changes in the pressure. This means that solutes extracted at high fluid densities can be extracted from the solvent simply by lowering the pressure.

Supercritical water is a medium where oxidation reactions can proceed at relatively low temperatures. This is an attractive alternative for hazardous waste destruction, since incineration produces undesirable by-products as a result of the high flame temperatures.

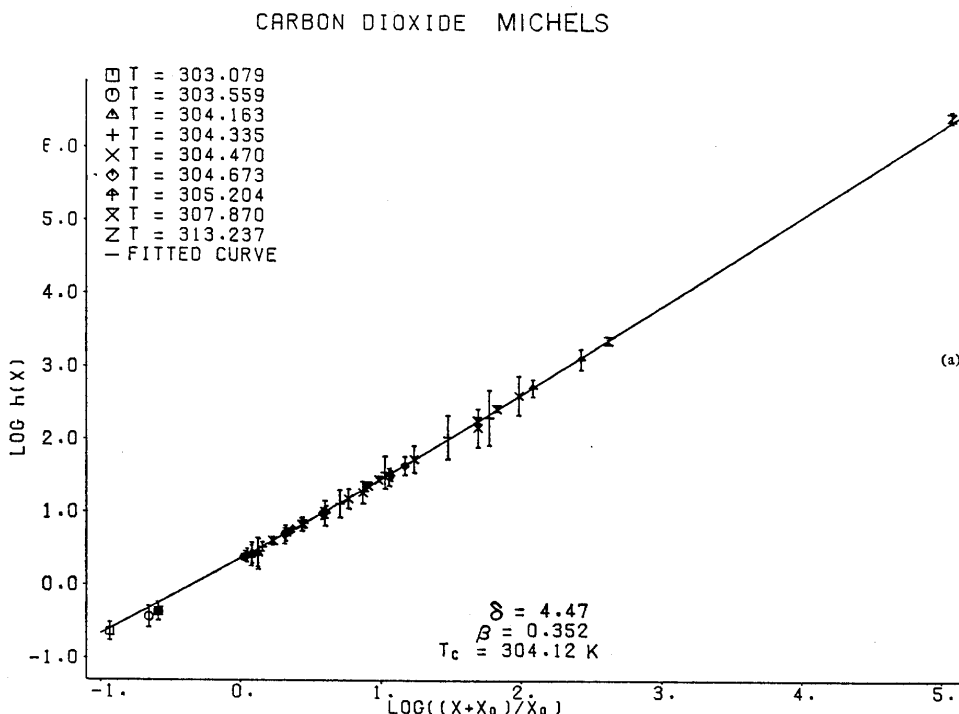

Fig. 1. This plot illustrates the accuracy of the scaling representation for carbon dioxide in the critical region. The scaling variable, x , has the value $-x_0$ on the liquid vapor coexistence curve. The solid line is fit to a particular form for $h(x)$ while the points are determined directly from the experimental data.

J. M. H. (Anneke) Levelt Sengers joined NBS in 1963 as a member of the Equation of State Section. A partial list of honors includes NIST Senior Fellow, Member of the National Academy of Engineering, and Member of the National Academy of Sciences. Her work on critical phenomena has taken many forms. In addition to the careful analytical work described here, she has performed many crucial experiments. She has worked extensively on the formulation of practical equations of state for water and steam [10]. In addition, she has examined the history of the development of the ideas underlying the scaling approach and has written some interesting and informative historical pieces [11,12].

M. S. Green joined NBS in 1954 and became the first Chief of the Statistical Physics Section in 1960. He was intensely interested in critical phenomena and organized the very successful conference that was held at NBS in 1965 [2]. In 1968 he left NBS to join the Physics Department of Temple University in Philadelphia. He maintained contact with NBS until his death in 1979. An excellent tribute to Mel by H. J. Raveché is found in the M. S. Green memorial volume [13].

M. Vicentini-Missoni was a guest worker at NBS while on leave from the University of Rome.

Prepared by Raymond D. Mountain.

Bibliography

- [1] M. Vicentini-Missoni, J. M. H. Levelt Sengers, and M. S. Green, Scaling Analysis of Thermodynamic Properties in the Critical Region of Fluids, *J. Res. Natl. Bur. Stand.* **73A**, 563-583 (1969).
- [2] M. S. Green and J. V. Sengers (eds.), *Critical Phenomena; Proceedings of a Conference Held in Washington, DC, April 1965*, NBS Miscellaneous Publication 273, National Bureau of Standards, Washington, DC (1966).
- [3] B. Widom, Equation of State in the Neighborhood of the Critical Point, *J. Chem. Phys.* **43**, 3898-3905 (1965).
- [4] R. B. Griffiths, Thermodynamic Functions for Fluids and Ferromagnets near the Critical Point, *Phys. Rev.* **158**, 176-187 (1967).
- [5] M. Vicentini-Missoni, J. M. H. Levelt Sengers, and M. S. Green, Thermodynamic anomalies of CO₂, Xe, and He⁴ in the critical region, *Phys. Rev. Lett.* **22**, 389-393 (1969).
- [6] M. Vicentini-Missoni, R. I. Joseph, M. S. Green, and J. M. H. Levelt Sengers, Scaled equation of state and critical exponents in magnets and fluids, *Phys. Rev. B* **1**, 2312-2331 (1970).
- [7] J. M. H. Levelt Sengers and J. V. Sengers, How Close is "Close to the Critical Point," in *Perspectives in Statistical Physics, M. S. Green Memorial Volume*, H. J. Raveché (ed.), North-Holland, Amsterdam (1981) pp. 239-271.
- [8] Z. Y. Chen, A. Abbaci, S. Tang, and J. V. Sengers, Global thermodynamic behavior of fluids in the critical region, *Phys. Rev. A* **42**, 4470-4484 (1990).
- [9] J. M. H. Levelt Sengers, Significant Contributions of IAPWS to the Power Industry, Science, and Technology, in *Physical Chemistry of Aqueous Systems: Meeting the Needs of Industry. Proceedings of the 12th International Conference on the Properties of Water and Steam*, H. J. White, J. V. Sengers, D. B. Neumann, and J. C. Bellows (eds.), Begell House, New York (1995).
- [10] J. M. H. Levelt Sengers, J. Straub, K. Watanabe, and P. G. Hill, Assessment of Critical Parameter Values for H₂O and D₂O, *J. Phys. Chem. Ref. Data* **14**, 193-207 (1985).
- [11] J. M. H. Levelt Sengers, Critical exponents at the turn of the century, *Physica* **82A**, 319-351 (1976).
- [12] J. M. H. Levelt Sengers, Liquidons and gasons; Controversies about the continuity of states, *Physica* **98A**, 363-402 (1979).
- [13] H. J. Raveché, Dedication to M. S. Green, in *Perspectives in Statistical Physics, M. S. Green Memorial Volume*, H. J. Raveché (ed.), North-Holland, Amsterdam (1981) pp. vii-xiv.

called a probe hole, can be made in the screen so that electron emission from a surface region composed of only ~ 15 – 30 atoms passes through the hole and then into the energy analyzer. This allows electron spectroscopy studies to be performed on the emission from just these few atoms. Deflection grids are used to focus the emitted current from a chosen portion of the surface over the probe hole. This experimental arrangement is shown in Fig. 1.

When a single atom, molecule, or cluster is adsorbed onto that portion of the surface emitting through the probe hole, if the adsorbate has an electron quasibound state near the Fermi level of the tip, then a substantial increase in the probe-hole current can occur as a result of resonance-tunneling enhancement through the adsorbate. New adsorbate-induced structure in the observed TED reflects the local density of electronic states of the adsorbate, which in turn leads to an unambiguous electron spectroscopy of single adsorbed atoms.

The physical origin of the effect can be understood from the potential energy diagram and wave functions shown in Figure 2. The “triangle barrier” field-emission configuration suggested earlier is here augmented by a potential well whose width $2w$ is roughly the diameter of the adsorbed atom, which is located a distance s from the surface. The electronic state of this atom is characterized by a discrete level which has been broadened into a band, referred to as the local density of states and labeled $\rho_a(\varepsilon)$ in Fig. 2. Enhanced tunneling occurs for

those tip states ψ_m whose energy is resonant with $\rho_a(\varepsilon)$, in which case the coherent process of tip-to-atom tunneling constructively interfering with atom-to-free space tunneling occurs with much greater probability (by factors sometimes as large as $\sim 10^2$ – 10^4) than for direct tip-to-free space tunneling. It is this magnification or amplification that is responsible for the collimated emission from the single adsorbate rising far above the background emission from other parts of the field emitter surface and, as detailed years later [3], is the underlying principle that enables atomic resolution in the scanning tunneling microscope.

In considering the spectroscopic characteristics of emission from the composite surface, it is most informative to measure and display R , the ratio of the change in TED to the original TED, as a function of energy. For typical adsorbate conditions, the theory outlined in the initial communication [1] shows that this ratio, for emission from the adsorbate-covered surface area, is

$$R(\varepsilon) \approx \sum_a [\rho_a(\varepsilon)/\rho_m(\varepsilon)] \exp[2\kappa(\varepsilon)(s+w_a)]$$

where the summation includes all the adsorbate states contributing to the tunneling, $\rho_a(\varepsilon)$ is the adsorbate density of states derived from state a , usually represented by a Lorentzian lineshape [4]

$$\rho_a(\varepsilon) \equiv \frac{1}{\pi} \frac{\Delta_a}{(\varepsilon - \varepsilon_a)^2 + \Delta_a^2}$$

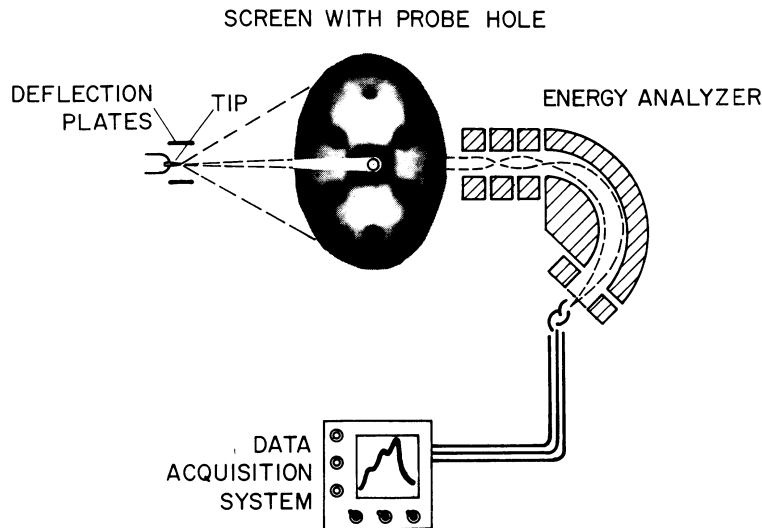

Fig. 1. Schematic drawing of a field emission microscope adapted for energy distribution measurements. The (110) plane of the emitter is positioned over the probe hole. Note that although an electrostatic deflection analyzer is shown here, the data reported in [1] were acquired with a retarding potential analyzer.

with ε_a and Δ_a , the resonance position and width, depending upon the particular state, $\rho_m(\varepsilon)$ the substrate density of states, w_a the “radius” of the atomic state, $\kappa(\varepsilon) \approx [(2m/\hbar)(\phi_e - \varepsilon)]^{1/2}$, and φ_e the workfunction of the tip. Observed structure in the TED that provides the desired spectroscopic information arises from $\rho_a(\varepsilon)$. The enhancement is mainly a consequence of the fact that now the rate-limiting step is tunneling from the adsorbate to vacuum, through a barrier that is reduced compared to the full direct metal-vacuum tunneling barrier. This enhancement is accounted for by the exponential factor. As was noted in the original paper [1], this realization of resonance tunneling involving an adsorbed atom (discrete state mixed with a continuum) can be (and was!) put in one-to-one correspondence with the Fano lineshape theory [4] which is the topic of another NBS/NIST classic publication outlined in this volume.

The initial spectroscopic experiments were carried out for single zirconium atoms deposited on a tungsten field emission tip; the published TED ratio is shown in Figure 3 together with two “relatively good fits” to the theoretical curve. This spectrum, crude even by standards a year later, nonetheless was a landmark. It expressed the first confirmation of the rather speculative beliefs of the time that the electronic energy level spectra of adsorbed atoms were related to the free atom spectra shifted and broadened ~ 1 eV by interaction with

the surface. Refined and extended presentations of this study soon followed which reached a much wider audience [5,6].

An unusually creative and imaginative period of research by the three coauthors over the next few years produced a wealth of new insights into the microscopic aspects of surfaces. The surface topografiner [7] invented and constructed by Young during this time period (and discussed elsewhere in this volume) was an initial version of the scanning tunneling microscope for which the 1986 Nobel Prize in Physics was awarded to Binnig, Rohrer, and Ruska. The field emission spectroscopy work of this period (mostly from NBS) has been summarized and reviewed by Gadzuk and Plummer in their *Reviews of Modern Physics* article [8], which is still one of the most definitive and comprehensive sources of widely used information and wisdom on this topic. The theory of resonance tunneling developed during this period is applicable in many areas of current interest and activity, for instance resonance tunneling in nanostructures such as quantum wells, quantum dots, and in the STM, as discussed in the 1993 *Physical Review* paper by Gadzuk [3].

The members of the trio have followed varied life trajectories over the ensuing decades. In 1973 Plummer joined the faculty at University of Pennsylvania, where he served as director of the Materials Research Laboratory from 1990 to 1992. Since 1992 he has held a joint

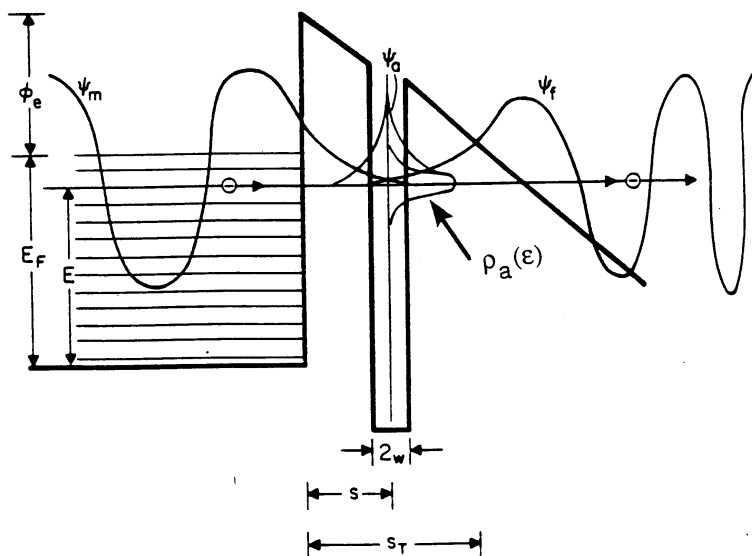

Fig. 2. Schematic model showing the idealized potentials relevant in field-emission resonance tunneling. The electron wave functions are: ψ_m , the unperturbed metal function; ψ_a , the localized adsorbate resonance function; and ψ_f , the emitted electron function. The adatom centered at $z = s$, with diameter equal to $2w$, shows a Lorentzian-like local density of states labeled ρ_a .

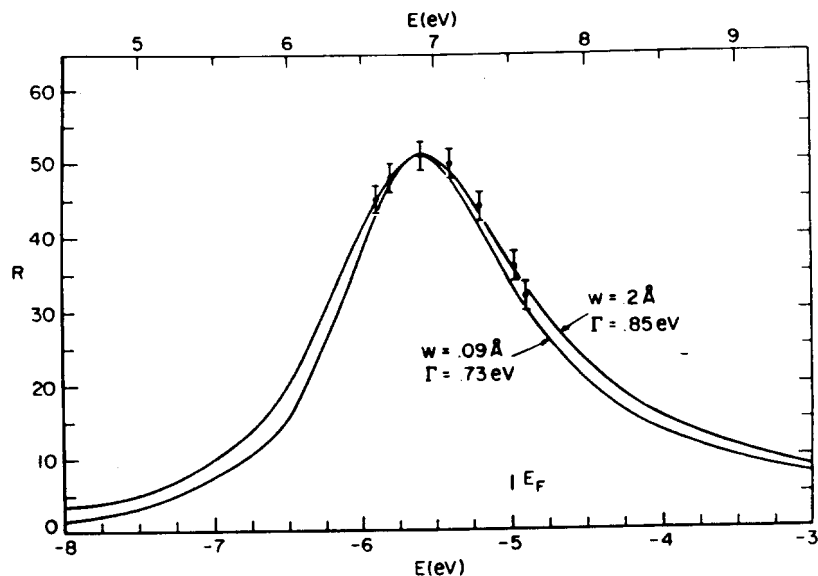

Fig. 3. Energy dependence of the ratio of the adsorbate-induced change in the TED to that of the clean surface, $R \equiv \Delta j'(\varepsilon)/j_0'(\varepsilon)$ vs. ε for a single zirconium atom on a tungsten field emission tip. Comparison of experiment with theory. The top energy axis is taken with respect to a zero at the bottom of the tungsten conduction band, while the zero for the bottom axis is at the vacuum potential outside the tip.

appointment as a Distinguished Professor of Physics at the University of Tennessee and as a Distinguished Scientist in the Solid State Division of Oak Ridge National Laboratory. He has authored or co-authored more than 260 papers reporting on a wide variety of physical and chemical properties of surfaces and interfaces, as probed with a multitude of experimental techniques, always maintaining close coupling with theory. He received the 1983 Davison-Germer Prize from the American Physical Society. Gadzuk remains at NBS/NIST, and for several years he was a "permanent" visiting professor jointly at NORDITA (Copenhagen) and Chalmers University (Goteborg). His research activities, resulting in over 150 papers, have been mainly in surface-related areas of theoretical atomic, molecular, solid state, and chemical physics, with special attention focused on the fundamental similarities existing in seemingly different fields of physics. He is currently interested in the dynamics of molecular processes at surfaces, particularly those aspects pertinent to the development of Femtochemistry at Surfaces involving hot electrons produced both by ultrafast lasers and by tunneling devices. He was a recipient of the Arthur

S. Fleming Award, given annually to the ten outstanding young men and women in the U.S. Federal service. Following the resonance tunneling work, Young brought to fruition his scanning device for measuring surface topography which, as acknowledged by the 1986 Physics Nobel Committee, was a prototype of the scanning tunneling microscope. After abrupt termination of this project in 1971, Young remained at NBS in both a technical and administrative role, first as a Section Chief and then a Division Chief, directing NBS activities in mechanical metrology and robotics until his formal retirement in 1981. Since then he has actively pursued his interests as an inventor; as a private consultant to industry and government (including NIST) on topics in metrology, STM, vibration isolation, and instrument development; and as a grandfather and a sailor. In recognition of his invention of the Topografiner, in 1986 he received a Presidential Citation, and in 1992 he was presented the Gaede-Langmuir Award of the American Vacuum Society.

Prepared by J. W. Gadzuk.

Resonance Tunneling of Field Emitted Electrons Through Adsorbates on Metal Surfaces

Initiation of the modern era of surface science, generally acknowledged as starting in the late 1960s, was made possible by two distinct qualitative leaps forward. One was the Sputnik-inspired development of ultra-high vacuum and electron-optical technologies. The other was the recognition and development of theoretical and measurement techniques for studying surface properties and processes on the (single!) atomic level. The field emission spectroscopy result reported in this 1969 NBS paper [1] was the first work in which the electronic energy level spectra of adsorbed atoms was observed and theoretically interpreted. All subsequent electron energy level spectroscopy of adsorbed atoms and molecules, whether based on tunneling processes such as in this work or on photon-induced processes, can legitimately be considered as logical consequences of this pioneering study. The spectroscopic information so obtained is the essential ingredient required in all quantum mechanical modeling of chemical bonding, catalysis, dynamics, and reactivity at solid surfaces, and it is for this reason that the advances reported in this paper have had lasting and historical significance.

The situation at NBS at the time was particularly well suited for the laboratory to become one of the three or four pre-eminent international centers of excellence leading the transformation of then-existing surface studies from a qualitative mystical art into a quantitative and intellectually stimulating hard science in which the basic systems and processes under study could be understood at the most fundamental atomic level. Major efforts in atomic and electron physics were focused on the development of monochromatic electron sources and energy analyzers (of special importance here, the work of John Simpson and Chris Kuyatt) and in their utilization for basic atomic physics studies, particularly those theoretically inspired by Ugo Fano (discussed elsewhere in this volume). A major direction in electron beam production relied upon field emitted/tunneled electrons as a promising source, and it was within this context that Russ Young came to NBS in 1961 and soon was attracting world-wide attention for his measurements and interpretation of field emission energy distributions as a new probe of the electronic state of surfaces [2]. Ward Plummer arrived at NBS in 1967 as an NRC postdoctoral fellow to work with

Young. In parallel with this surface work in atomic physics, complementary experimental research within the domain of physical chemistry (also discussed elsewhere in this volume) and in metallurgy (by Al Melmed) gave a cross-disciplinary flavor, across NBS organizational boundaries, to surface science. This situation was successfully used to persuade NBS management to create a new inter-institute position for a surface theorist, which enabled Bill Gadzuk to join NBS in 1968. Almost immediately, it became clear that the intellectual and personal chemistry among Plummer, Gadzuk, and Young was right, and a highly productive collaboration proceeded for the next several years in the area of electron spectroscopy of surfaces, in which all sorts of new things were discovered, studied, and understood. The topic of this paper [1] has perhaps had the most long lasting and global significance, both because it was the first definitive experimental/theoretical study of the quantum states of adsorbates and also because the basic phenomenon of resonance tunneling has been so important in microelectronics and in nanostructures.

The field-emission microscope (FEM) and its derivative spectroscopies are based on the fact that a modest positive potential (~ 1 keV–3 keV) applied between a sharpened conducting tip (radius ~ 100 nm) and a flat or concentric spherical electrode, positioned a macroscopic distance (~ 1 cm–10 cm) away, will result in an electric field at the emitter surface whose strength is ~ 1 V/nm–10 V/nm, as depicted in Figs. 1 and 2. This field is strong enough to allow electrons to quantum mechanically tunnel from the tip (on the left) into the free space (on the right). Energy analysis of the emitted electrons reveals a total energy distribution (TED) of emitted electrons that is exponentially decreasing in number below the sharp, high energy Fermi edge and which has an ~ 1.0 eV width under typical field emission conditions [2]. If a fluorescent screen is introduced behind the accelerating electrode, then a spatial distribution of the electron emission from the tip can be imaged. This distribution will have a spatial resolution of a few nanometers. Contrast in the image is due to variations in electron emission across the tip surface, historically attributed to variations in the surface work function. Furthermore, a “small” hole,

called a probe hole, can be made in the screen so that electron emission from a surface region composed of only ~ 15 – 30 atoms passes through the hole and then into the energy analyzer. This allows electron spectroscopy studies to be performed on the emission from just these few atoms. Deflection grids are used to focus the emitted current from a chosen portion of the surface over the probe hole. This experimental arrangement is shown in Fig. 1.

When a single atom, molecule, or cluster is adsorbed onto that portion of the surface emitting through the probe hole, if the adsorbate has an electron quasibound state near the Fermi level of the tip, then a substantial increase in the probe-hole current can occur as a result of resonance-tunneling enhancement through the adsorbate. New adsorbate-induced structure in the observed TED reflects the local density of electronic states of the adsorbate, which in turn leads to an unambiguous electron spectroscopy of single adsorbed atoms.

The physical origin of the effect can be understood from the potential energy diagram and wave functions shown in Figure 2. The “triangle barrier” field-emission configuration suggested earlier is here augmented by a potential well whose width $2w$ is roughly the diameter of the adsorbed atom, which is located a distance s from the surface. The electronic state of this atom is characterized by a discrete level which has been broadened into a band, referred to as the local density of states and labeled $\rho_a(\varepsilon)$ in Fig. 2. Enhanced tunneling occurs for

those tip states ψ_m whose energy is resonant with $\rho_a(\varepsilon)$, in which case the coherent process of tip-to-atom tunneling constructively interfering with atom-to-free space tunneling occurs with much greater probability (by factors sometimes as large as $\sim 10^2$ – 10^4) than for direct tip-to-free space tunneling. It is this magnification or amplification that is responsible for the collimated emission from the single adsorbate rising far above the background emission from other parts of the field emitter surface and, as detailed years later [3], is the underlying principle that enables atomic resolution in the scanning tunneling microscope.

In considering the spectroscopic characteristics of emission from the composite surface, it is most informative to measure and display R , the ratio of the change in TED to the original TED, as a function of energy. For typical adsorbate conditions, the theory outlined in the initial communication [1] shows that this ratio, for emission from the adsorbate-covered surface area, is

$$R(\varepsilon) \approx \sum_a [\rho_a(\varepsilon)/\rho_m(\varepsilon)] \exp[2\kappa(\varepsilon)(s+w_a)]$$

where the summation includes all the adsorbate states contributing to the tunneling, $\rho_a(\varepsilon)$ is the adsorbate density of states derived from state a , usually represented by a Lorentzian lineshape [4]

$$\rho_a(\varepsilon) \equiv \frac{1}{\pi} \frac{\Delta_a}{(\varepsilon - \varepsilon_a)^2 + \Delta_a^2}$$

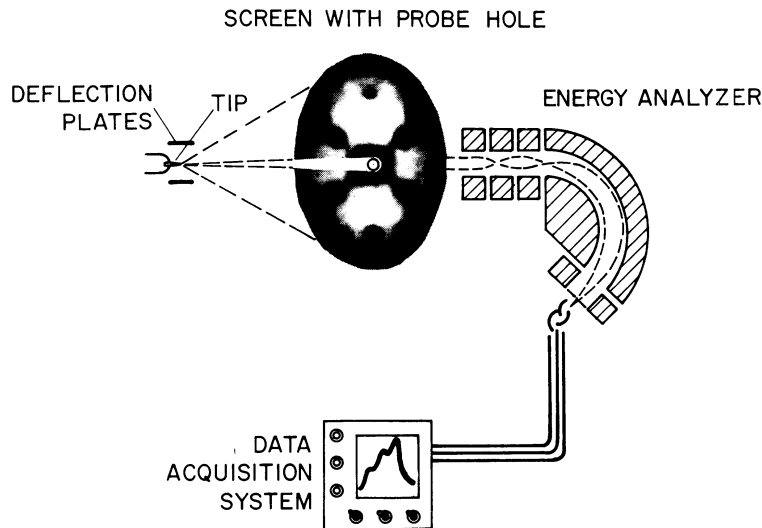

Fig. 1. Schematic drawing of a field emission microscope adapted for energy distribution measurements. The (110) plane of the emitter is positioned over the probe hole. Note that although an electrostatic deflection analyzer is shown here, the data reported in [1] were acquired with a retarding potential analyzer.

with ε_a and Δ_a , the resonance position and width, depending upon the particular state, $\rho_m(\varepsilon)$ the substrate density of states, w_a the “radius” of the atomic state, $\kappa(\varepsilon) \approx [(2m/\hbar)(\phi_e - \varepsilon)]^{1/2}$, and φ_e the workfunction of the tip. Observed structure in the TED that provides the desired spectroscopic information arises from $\rho_a(\varepsilon)$. The enhancement is mainly a consequence of the fact that now the rate-limiting step is tunneling from the adsorbate to vacuum, through a barrier that is reduced compared to the full direct metal-vacuum tunneling barrier. This enhancement is accounted for by the exponential factor. As was noted in the original paper [1], this realization of resonance tunneling involving an adsorbed atom (discrete state mixed with a continuum) can be (and was!) put in one-to-one correspondence with the Fano lineshape theory [4] which is the topic of another NBS/NIST classic publication outlined in this volume.

The initial spectroscopic experiments were carried out for single zirconium atoms deposited on a tungsten field emission tip; the published TED ratio is shown in Figure 3 together with two “relatively good fits” to the theoretical curve. This spectrum, crude even by standards a year later, nonetheless was a landmark. It expressed the first confirmation of the rather speculative beliefs of the time that the electronic energy level spectra of adsorbed atoms were related to the free atom spectra shifted and broadened ~ 1 eV by interaction with

the surface. Refined and extended presentations of this study soon followed which reached a much wider audience [5,6].

An unusually creative and imaginative period of research by the three coauthors over the next few years produced a wealth of new insights into the microscopic aspects of surfaces. The surface topografiner [7] invented and constructed by Young during this time period (and discussed elsewhere in this volume) was an initial version of the scanning tunneling microscope for which the 1986 Nobel Prize in Physics was awarded to Binnig, Rohrer, and Ruska. The field emission spectroscopy work of this period (mostly from NBS) has been summarized and reviewed by Gadzuk and Plummer in their *Reviews of Modern Physics* article [8], which is still one of the most definitive and comprehensive sources of widely used information and wisdom on this topic. The theory of resonance tunneling developed during this period is applicable in many areas of current interest and activity, for instance resonance tunneling in nanostructures such as quantum wells, quantum dots, and in the STM, as discussed in the 1993 *Physical Review* paper by Gadzuk [3].

The members of the trio have followed varied life trajectories over the ensuing decades. In 1973 Plummer joined the faculty at University of Pennsylvania, where he served as director of the Materials Research Laboratory from 1990 to 1992. Since 1992 he has held a joint

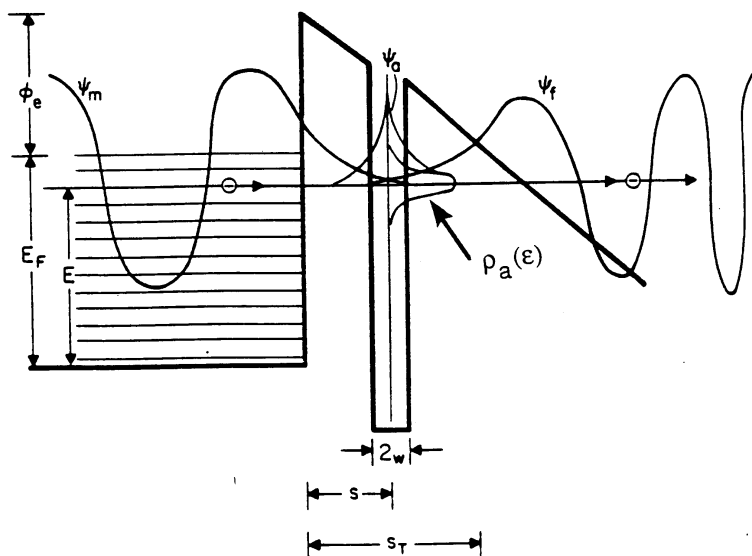

Fig. 2. Schematic model showing the idealized potentials relevant in field-emission resonance tunneling. The electron wave functions are: ψ_m , the unperturbed metal function; ψ_a , the localized adsorbate resonance function; and ψ_f , the emitted electron function. The adatom centered at $z = s$, with diameter equal to $2w$, shows a Lorentzian-like local density of states labeled ρ_a .

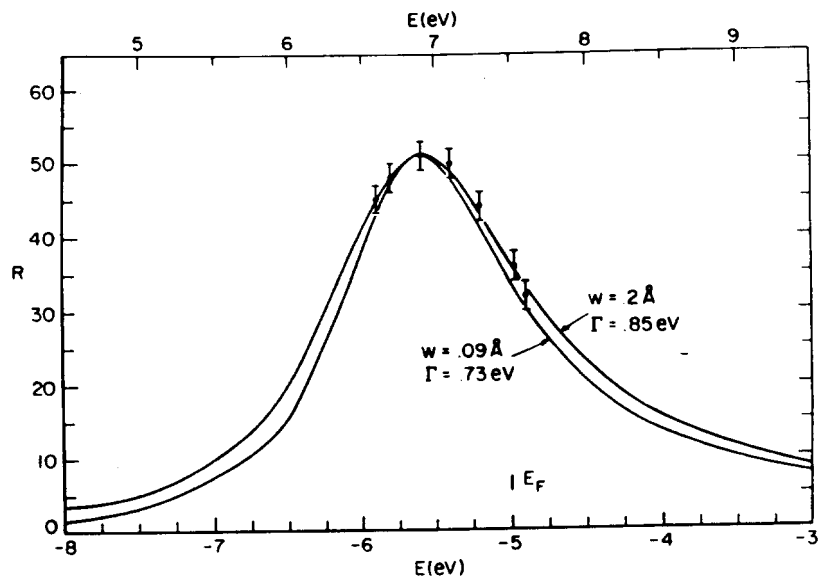

Fig. 3. Energy dependence of the ratio of the adsorbate-induced change in the TED to that of the clean surface, $R \equiv \Delta j'(\varepsilon)/j_0'(\varepsilon)$ vs. ε for a single zirconium atom on a tungsten field emission tip. Comparison of experiment with theory. The top energy axis is taken with respect to a zero at the bottom of the tungsten conduction band, while the zero for the bottom axis is at the vacuum potential outside the tip.

appointment as a Distinguished Professor of Physics at the University of Tennessee and as a Distinguished Scientist in the Solid State Division of Oak Ridge National Laboratory. He has authored or co-authored more than 260 papers reporting on a wide variety of physical and chemical properties of surfaces and interfaces, as probed with a multitude of experimental techniques, always maintaining close coupling with theory. He received the 1983 Davison-Germer Prize from the American Physical Society. Gadzuk remains at NBS/NIST, and for several years he was a "permanent" visiting professor jointly at NORDITA (Copenhagen) and Chalmers University (Goteborg). His research activities, resulting in over 150 papers, have been mainly in surface-related areas of theoretical atomic, molecular, solid state, and chemical physics, with special attention focused on the fundamental similarities existing in seemingly different fields of physics. He is currently interested in the dynamics of molecular processes at surfaces, particularly those aspects pertinent to the development of Femtochemistry at Surfaces involving hot electrons produced both by ultrafast lasers and by tunneling devices. He was a recipient of the Arthur

S. Fleming Award, given annually to the ten outstanding young men and women in the U.S. Federal service. Following the resonance tunneling work, Young brought to fruition his scanning device for measuring surface topography which, as acknowledged by the 1986 Physics Nobel Committee, was a prototype of the scanning tunneling microscope. After abrupt termination of this project in 1971, Young remained at NBS in both a technical and administrative role, first as a Section Chief and then a Division Chief, directing NBS activities in mechanical metrology and robotics until his formal retirement in 1981. Since then he has actively pursued his interests as an inventor; as a private consultant to industry and government (including NIST) on topics in metrology, STM, vibration isolation, and instrument development; and as a grandfather and a sailor. In recognition of his invention of the Topografiner, in 1986 he received a Presidential Citation, and in 1992 he was presented the Gaede-Langmuir Award of the American Vacuum Society.

Prepared by J. W. Gadzuk.

Bibliography

- [1] E. W. Plummer, J. W. Gadzuk, and R. D. Young, Resonance Tunneling of Field Emitted Electrons Through Adsorbates on Metal Surfaces, *Solid State Commun.* **7**, 487-491 (1969).
- [2] R. D. Young, Theoretical Total-Energy Distribution of Field-Emitted Electrons, *Phys. Rev.* **113**, 110-114 (1959).
- [3] J. W. Gadzuk, Single-atom point source for electrons: Field-emission resonance tunneling in scanning tunneling microscopy, *Phys. Rev. B* **47**, 12832-12839 (1993).
- [4] U. Fano, Effects of Configuration Interaction on Intensities and Phase Shifts, *Phys. Rev.* **124**, 1866-1878 (1961).
- [5] E. W. Plummer and R. D. Young, Field-Emission Studies of Electronic Energy Levels of Adsorbed Atoms, *Phys. Rev. B* **1**, 2088-2109 (1970).
- [6] J. W. Gadzuk, Resonance-Tunneling Spectroscopy of Atoms Adsorbed on Metal Surfaces: Theory, *Phys. Rev. B* **1**, 2110-2129 (1970).
- [7] R. Young, J. Ward, and F. Scire, The Topografiner: An Instrument for Measuring Surface Microtopography, *Rev. Sci. Instrum.* **43**, 999-1011 (1972).
- [8] J. W. Gadzuk and E. W. Plummer, Field Emission Energy Distribution[s] (FEED), *Rev. Mod. Phys.* **45**, 487-548 (1973).

Quantitative Electron Probe Microanalysis

The recognition and understanding of the role of the microstructure in controlling the macroscopic behavior of a material has been a major theme of science and technology throughout the history of NBS/NIST. In materials science, the late 19th century saw the development of the sample preparation procedures we know today as “metallography” and “materialography,” and the emergence of optical microscopes with resolution performance at the physically defined optical limit. Applied to practical technological issues such as understanding the thermomechanical processing of steel to control its strength and ductility, the new microstructural science revealed a vast array of microstructural features, many of which were obviously compositional in nature. By 1912, the noted Harvard scientist Prof. Albert Sauveur could remark “To realize the practical importance of metallography, it should be borne in mind that the physical properties of metals and alloys—that is, those properties to which those substances owe their exceptional industrial importance—are much more closely related to their proximate than to their ultimate composition, and that microscopical examination reveals, in part at least, the proximate composition of metals and alloys, whereas chemical analysis seldom does more than reveal their ultimate composition” (Here the “ultimate composition” is what we today would refer to as the bulk composition, while the “proximate composition” refers to the local microstructural composition.) Sauveur continued in his enthusiastic and colorful prose: “Unfortunately the chemist too often is able to give us positive information in regard to the proportion of the ultimate constituents only, his reference to proximate analysis being of the nature of speculation. Ultimate analysis has reached a high degree of perfection in regard to accuracy as well as to speed of methods and analytical chemists have built up a marvelous structure calling for the greatest admiration, their searching methods never failing to lay bare the ultimate composition of substances. But how much darkness still surrounds the proximate composition of bodies and how great the reward awaiting the lifting of the veil!”

The beginning of the solution to Sauveur’s dream came in 1949 with the first results from the electron probe x-ray microanalyzer (EPMA) by Raymond Castaing, a student of A. Guinier at the University of Paris. Castaing presented an extraordinary thesis that described both the complete development of a unique measurement tool for microstructural characterization

and a detailed treatment of the underlying physics of electron/x-ray interaction with matter that would provide the framework for developing the new technique into a rigorous quantitative analysis tool. The first stage of this task took nearly 20 years and the contributions of many scientists from Europe, Japan, and the United States, including those of Kurt F. J. Heinrich and his colleagues at NBS. To evaluate the state of the development of quantitative analysis and to stimulate further progress in the measurement science of electron probe microanalysis, Heinrich organized a special workshop in June of 1967 that brought together the leaders of the field. The document of this gathering, NBS Special Publication 298, *Quantitative Electron Probe Microanalysis* [1], edited by Heinrich, became the “bible” of the rapidly developing field. It was understood from Castaing’s thesis work that a quantification scheme should proceed from the measurement of the x-ray intensities emitted by the unknown and, under the same beam conditions, from a simple standard suite consisting of pure elements and/or binary compounds. What was needed were correction factors based upon physical calculations of electron penetration and scattering, x-ray absorption, and consequent secondary x-ray fluorescence to convert relative measured x-ray intensities into relative concentrations. Extensive work to develop practical expressions for these factors and obtain the physical data (e.g., x-ray mass absorption coefficients, electron backscatter coefficients, etc.) was being done by researchers organized essentially along national lines. NBS Special Publication 298 brought together the various camps to present their work and the critical details on just how they proposed to implement these complex calculations. Most importantly, SP 298 contained the first robust tests based upon critical data sets that provided a rigorous comparison of the performance of different implementations of correction factors. Thus, the strengths and weaknesses of the algorithms under development could be accurately assessed, and future directions for continuing research could be sensibly planned, propelling the field forward. SP 298 also surveyed newly emerging areas of application, such as biological materials, where a solution was provided to the problem that radiation damage to the specimen limited the utility of the results. Changes in the electron bombarded region could be compensated through measurements of the high energy x-ray continuum.

Kurt Heinrich came to NIST in 1963 from the Dupont Research Station to initiate a competence for NBS in the area of electron beam microanalysis, which had grown slowly through the 1950s until the great acceleration of scientific and technological efforts in the post-Sputnik era led to the development of several commercial EPMA instruments. Heinrich assembled an electron beam group initially including Robert Myklebust, Charles Fiori, Donald Vieth, and Stanley Rasberry, with the close collaboration of Harvey Yakowitz from the Metallurgy Division. Visitors included Jean Henoc of Centre National d'Etudes de Telecommunication (France) and Carol Swyt of the National Institutes of Health. Fig. 1 shows an example of an early EPMA instrument at NBS. Later, Ryna Marinenko, John Small, Eric Steel, and Dale Newbury joined the effort toward development of the measurement science of elemental microanalysis and its application to a wide variety of problems in materials science, semiconductor technology, environmental chemistry, failure analysis, and forensic analysis.

EPMA involves the use of finely-focused electron beams with incident energies usually selected in the range from 10 keV–25 keV to excite characteristic

x rays from a microscopic target. Initially, the lateral spatial resolution of EPMA was limited by the electron-optical performance to the minimum beam size that could be focused with sufficient current for practical x-ray spectrometry by wavelength dispersive spectrometry (crystal diffractometry). The micrometer spatial resolution that Castaing reported in his thesis stood for nearly 20 years because microampere currents were needed to excite a sufficient x-ray flux to overcome the low efficiency of diffraction spectrometers. Large current demanded large beam size. This problem was substantially solved with the development of the semiconductor energy dispersive spectrometer (Si-EDS) with geometric and quantum efficiencies that permitted practical x-ray spectrometry with beam currents in the nanoampere range. Heinrich collaborated on the watershed paper introducing the semiconductor EDS to the electron probe field [2]. With semiconductor EDS, microanalysts could take advantage of the rapid, parallel developments in imaging that took place in the late-1960s with the advent of high resolution scanning electron microscopes (SEM). The EPMA quickly evolved into an SEM electron-optical platform capable of imaging with beam diameters of 50 nm and smaller,



Fig. 1. Kurt Heinrich with his EMPA apparatus.

equipped with both crystal diffractometers (for high spectral resolution) and semiconductor EDS (for continuous viewing of the complete x-ray spectrum). Moreover, with submicrometer beam diameters, the EPMA could achieve spatial resolutions limited only by the physics of electron scattering. For intermediate and high atomic number specimens ($Z > 20$), lateral and depth spatial resolutions below $1\ \mu\text{m}$ became possible. The modern EPMA/EDS/WDS can thus image and then selectively analyze discrete sample masses of the order of $1\ \text{pg}$ ($10^{-12}\ \text{g}$), e.g., an isolated particle, with fractional detection limits of $1\ \text{fg}$ ($10^{-15}\ \text{g}$) or less within this picogram sample. This extremely small sample mass was six or more orders of magnitude below the minimum mass that could be studied with contemporary "conventional" chemical analysis [3].

Despite the small mass of the sample selected by the beam interaction, the EPMA measurement can be performed quantitatively with a relative accuracy of $\pm 0.5\%$ or better and precision of $\pm 0.5\%$. The framework for quantification that was laid down by Castaing was refined and enhanced by numerous workers, and the Heinrich group made many important contributions to the success of the method. The x-ray spectrum is affected by a wide range of physical phenomena. The incident electron beam undergoes elastic and inelastic scattering (energy loss) leading to a complex distribution in depth of electron density and ionization power as well as the loss of electrons from the target due to backscattering through the cumulative effects of elastic scattering. The characteristic x rays produced through inner shell ionization must propagate through the specimen, often over a distance of micrometers, to escape through the surface in the direction of the x-ray detector. Along this path, the x rays are subject to photoelectric absorption which attenuates the intensity. Photoelectric absorption leads to secondary fluorescence through ionization of inner shells of the absorbing specimen atoms, which subsequently emit their characteristic x rays. This secondary emission is an additional source of intensity beyond that due to direct electron excitation of those same atoms. The great complication is that each of these radiation interactions, (1) electron scattering, retardation, and ionization power, (2) x-ray absorption, and (3) secondary x-ray fluorescence, is a function of composition, which is unknown. Finally, absorption in the components of the spectrometer and the spectrometer response (efficiency) modify the emitted spectrum to yield the final observed spectrum. Determination of these interelement or "matrix effects" and instrumental effects form the basis for quantitative analysis. NBS/NIST scientists employed a three-pronged approach for this research: (1) studies of the parameters of electron beam/x-ray interactions that form

the physical basis of matrix corrections; (2) development of computer software incorporating the physical corrections for efficient calculations; and (3) development of microanalysis standard reference materials.

The study of the interaction of electrons and x rays with matter was an area of intense interest to physics in the first half of the 20th century. By the time EPMA had arisen in the 1950s, physics had moved on to much higher and much lower energies, and interest in measuring data for the EPMA energy range had waned. Those who were interested in developing accurate corrections for electron/x-ray matrix effects in EPMA needed accurate values of key parameters such as electron backscattering coefficients, loss of x-ray production due to backscattering, x-ray mass absorption coefficients, etc. Whenever possible, literature values were utilized, but many critical values were simply unavailable, so extensive measurements and simulations were undertaken by the EPMA community, including the NBS/NIST group [4-8].

Consistent with the mission of NBS/NIST, matrix correction methods for quantitative analysis have been made accessible to U.S. industry and academia through the development of state of the art software that incorporated the laboratory measurement advances in a form that could be readily implemented elsewhere. The development of quantitative EPMA closely follows the remarkable evolution of computing power that is the major theme of the second half of the 20th century. As each advance took place in central computing power in the early years, and then in personal computing power in later years, NBS/NIST quantitative microanalysis software was developed to take full advantage of the improving speed and capacity of computers. Thus there are two parallel series of publications, one set of scientific papers that detail the NBS/NIST contributions to the basic understanding of electron beam/x-ray interactions and matrix corrections for quantitative EPMA analysis, and a second set of papers documenting the software implementation of the mathematical algorithms for these corrections. The open description of this software code enabled U.S. manufacturers of x-ray spectrometry to incorporate NBS/NIST developments into their products [9-13].

The third component of the NBS/NIST program in microanalysis research has been the development of NBS/NIST Standard Reference Materials (SRM) appropriate to the electron probe microanalysis case, which places an unusually great demand on sample homogeneity. The EPMA beam selects a region with micrometer dimensions, so for measurement reproducibility, we must require that our sample be homogeneous down to a much finer scale, ideally approaching the atomic scale. While NIST offers a great many SRMs,

Nature seems generally to abhor homogeneity on the microstructural scale, so that most SRMs created for “bulk” applications do not satisfy the stringent requirements for microstructural homogeneity necessary for EPMA. Most arbitrarily selected groupings of elements when properly synthesized together do not form a uniform material on the micrometer scale. Careful selection and rigorous homogeneity testing of metallic alloys and glasses has resulted in a series of microanalysis SRMs which serve the community in the important role of test materials [14-16].

Finally, these techniques for quantitative EPMA were developed in an environment in which problem solving was encouraged and promoted. Collaborations throughout NBS/NIST and with other federal agencies brought many challenging applications for EPMA, including materials science, failure analysis, electronic technology, biological science, and forensic analysis.

Prepared by Dale E. Newbury.

Bibliography

- [1] K. F. J. Heinrich (ed.), *Quantitative Electron Probe Microanalysis*, NBS Special Publication 298, National Bureau of Standards, Washington, DC (1968).
- [2] R. Fitzgerald, K. Keil, and K. F. J. Heinrich, Solid-State Energy-Dispersion Spectrometer for Electron-Microprobe X-ray Analysis, *Science* **159**, 528-530 (1968).
- [3] K. F. J. Heinrich, D. E. Newbury, R. L. Myklebust, and C. E. Fiori (eds.), *Energy Dispersive X-ray Spectrometry*, NBS Special Publication 604, National Bureau of Standards, Washington, DC (1981).
- [4] K. F. J. Heinrich, Electron Probe Microanalysis by Specimen Current Measurement, in *Fourth International Symposium on X-ray Optics and X-ray Microanalysis, Orsay, France, 1965*, Hermann, Paris (1966) pp. 159-167.
- [5] K. F. J. Heinrich, X-ray absorption uncertainty, in *The Electron Microprobe*, T. D. McKinley, H. F. J. Heinrich, and D. B. Wittry (eds.), John Wiley and Sons, New York (1966) pp. 296-377.
- [6] Kurt F. J. Heinrich, Errors in theoretical correction systems in quantitative electron probe microanalysis—a synopsis, *Anal. Chem.* **44**, 350-354 (1972).
- [7] Kurt F. J. Heinrich, Dale E. Newbury, and Harvey Yakowitz (eds.), *Use of Monte Carlo Calculations in Electron Probe Microanalysis and Scanning Electron Microscopy*, NBS Special Publication 460, National Bureau of Standards, Washington, DC (1976).
- [8] J. A. Small, D. E. Newbury, and R. L. Myklebust, *X-Ray Bremsstrahlung Intensities from Elemental Targets*, NBS Technical Note 1245, National Bureau of Standards, Gaithersburg, MD (1988).
- [9] Kurt F. J. Heinrich, Robert L. Myklebust, Harvey Yakowitz, Stanley D. Rasberry, *A Simple Correction Procedure for Quantitative Electron Probe Microanalysis*, NBS Technical Note 719, National Bureau of Standards, Washington, DC (1972).
- [10] H. Yakowitz, R. L. Myklebust, and K. F. J. Heinrich, *FRAME: An On-Line Correction Procedure for Quantitative Electron Probe Microanalysis*, NBS Technical Note 796, National Bureau of Standards, Washington, DC (1973).
- [11] Jean Henoc, Kurt F. J. Heinrich, and Robert L. Myklebust, *A Rigorous Correction Procedure for Quantitative Electron Probe Microanalysis (COR 2)*, NBS Technical Note 769, National Bureau of Standards, Washington, DC (1973).
- [12] R. L. Myklebust, C. E. Fiori, and K. F. J. Heinrich, *FRAME C: A Compact Procedure for Quantitative Energy-Dispersive Electron Probe X-ray Analysis*, NBS Technical Note 1106, National Bureau of Standards, Washington, DC (1979).
- [13] Charles E. Fiori and Carol R. Swyt, *Desk Top Spectrum Analyzer*, United States Patent 5,299,138, March 29, 1994.
- [14] Kurt F. J. Heinrich, Robert L. Myklebust, Stanley D. Rasberry, and Robert E. Michaelis, *Preparation and Evaluation of SRMs 481 and 482: Gold-Silver and Gold-Copper Alloys for Microanalysis*, NBS Special Publication 260-28, National Bureau of Standards, Washington, DC (1971).
- [15] R. B. Marinenko, F. Biancanello, L. DeRobertis, P. A. Boyer, and A. W. Ruff, *Preparation and Characterization of an Iron-Chromium-Nickel Alloy for Microanalysis: SRM 479a*, NBS Special Publication 260-70, National Bureau of Standards, Washington, DC (1981).
- [16] R. B. Marinenko, *Preparation and Characterization of K-411 and K-412 Mineral Glasses for Microanalysis: SRM 470*, NBS Special Publication 260-74, National Bureau of Standards, Washington, DC (1982).

Limits for Qualitative Detection and Quantitative Determination

A visiting professor at NIST once pointed out that our measurement professionals are given a difficult task by some of our customers. In a (macroscopically) continuum universe, we are asked to perform measurements with tools and techniques of finite precision and in the end to produce digital answers, preferably binary: yes or no, safe or unsafe, above or below the regulatory limit. A common triple question arises in the measurement of environmental radioactivity, atmospheric ozone, gold in rock, or the efficacy of a flu treatment: Is the signal there? What is the chance that we will detect it? How big is it?

Until Lloyd Currie's paper *Limits for Qualitative Detection and Quantitative Determination: Application to Radiochemistry* [1] was published, there was enough inconsistency in the definition of "detection limit" to conceal a great deal of disagreement. In just over seven pages, this tightly written communication established a high level of uniformity in answering these questions. The paper contains fundamental information that has made it influential far beyond its size, and it is rich enough to be discussed actively in e-mail newsgroups over 30 years later. This is surely one of the most often cited publications in analytical chemistry. The *Science Citation Index* lists 1280 published references to this paper—so far.

Currie asks and answers a disarmingly simple question: What do we mean by the detection limit of a measurement process? He found that the literature "revealed a plethora of mathematical expressions and widely-ranging terminology." The same terms have been used to denote both the amount that can be detected and the amount that can be measured, which are very different quantities. Statistical justification for some common recipes has been absent or incorrect.

To show graphically how serious the problem was (and is), he used literature definitions to compare detection limits, defined by eight common recipes, or rules of thumb, for a simple measurement: counting a radioactive source for 10 minutes with a detector that is 10 % efficient and has a background of 20 counts per minute. Currie then arranged the values of the detection limit in serial order, and found that the range of these definitions spans a factor of nearly 1000. His Figure 1, reproduced here, clearly showed the need for a consistent, statistically and physically defensible, definition of this common term.

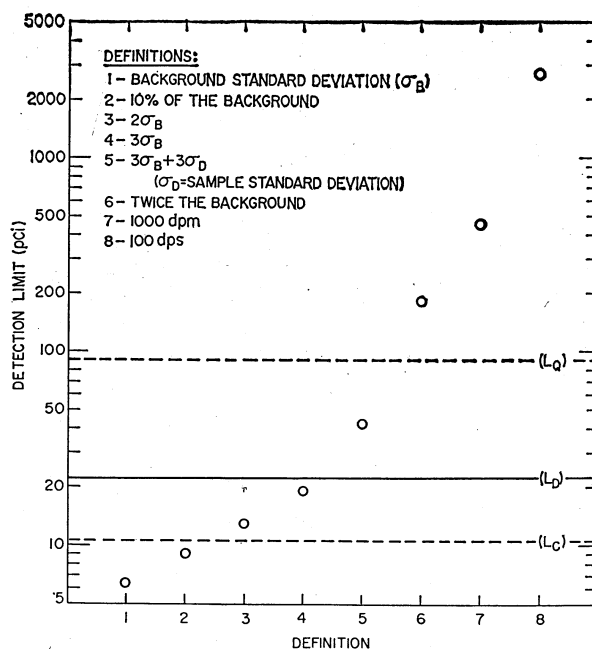

Fig.1. "Ordered" detection limits—literature definitions. The detection limit for a specific radioactivity measurement process is plotted in increasing order, according to commonly-used alternative definitions. L_C , L_D , and L_Q are the critical level, detection level, and determination limit as derived in the text.

Currie then defined measures of detectability, firmly based on the statistical theory of hypothesis testing. He began by defining the concepts of qualitative and quantitative analysis limits. Three limiting levels were defined:

- The critical level L_C , the signal level above which an observed instrument response may be reliably recognized as "detected."
- The detection limit L_D , the true net signal level that may be expected a priori to lead to detection.
- The determination limit L_Q , the signal level above which a quantitative measurement can be performed with a stated relative uncertainty.

Numerical values of these levels depend on four criteria, most importantly the standard deviation σ_0 of the blank, or background. By choosing a probability α (error of the first kind) for falsely deciding that the

signal is present when in fact it is not, the critical level L_C is calculable. Choosing a probability β (error of the second kind) for deciding that the signal is absent when it is in fact present permits the detection limit L_D to be calculated. Finally, specifying the maximum tolerable statistical error in a quantitative measurement allows the determination limit L_Q to be computed. “The levels L_C , L_D , and L_Q are determined entirely by the error-structure of the measurement process, the risks, α and β , and the maximum acceptable relative standard deviation for quantitative analysis. L_C is used to test an experimental result, whereas L_D and L_Q refer to the capabilities of [the] measurement process itself.”

Currie then gives recipes for calculating these quantities, for the conventional assumptions of a normal distribution; 5 % errors of the first and second kind; the uncertainty of the blank independent of the signal level; and quantitation at 10 % or better. His Table I has been reprinted in many textbooks and operating manuals:

Table I: “Working” Expressions for L_C , L_D , and L_Q *

	L_C	L_D	L_Q
Paired observations	$2.33 \sigma_B$	$4.65 \sigma_B$	$14.1 \sigma_B$
“Well-known” blank	$1.64 \sigma_B$	$3.29 \sigma_B$	$10 \sigma_B$

*Assumptions: $\alpha = \beta = 0.05$; $k_Q = 10$; $\sigma = \sigma_0 = \text{constant}$

For radioactivity or a similar counting measurement, where the data are digital and the distribution Poisson-Normal, the equations are particularly simple; for example, if the background is exactly zero with no uncertainty, then $L_C = 0$ counts, $L_D \approx 2.71$, and $L_Q = 100$. In agreement with experience, this means that any observed count will be evidence of a non-zero signal, and 100 counts gives a standard uncertainty of $\sqrt{100}/(100) = 10\%$. A more rigorous formulation for L_D , for extreme low-level counting, using the exact Poisson distribution, was given by Currie in 1972. Here, $L_D = 3.00$ replaces the Poisson-Normal approximation of 2.71 counts [2].

To make his 1968 paper still more concrete, three specific illustrations of analytical procedures were given, with worked-out equations for the three quantities: spectrophotometry, radioactivity, and a complex case of activation analysis.

This seminal paper has been elaborated in many contexts (e.g., [3]) and has led to an American Chemical Society symposium on the topic [4]. Currie’s formulation was so convincing that it has been universally incorporated in many rules of practice governing measurement procedures, international standards [5],

regulations [6], and software. The culmination of Currie’s early work was seen in the adoption of a harmonized international position (ISO-IUPAC) on the nomenclature, concepts, and formulation of detection, decision, and determination limits [7]. The IUPAC position has been further embedded in the new edition of its definitive guide for analytical chemistry [8]. Few scientific papers have been so definitive and decisive, or so clearly set the standards of subsequent discourse. This work is central to the NBS/NIST role in measurement science.

Lloyd A. Currie attended the Massachusetts Institute of Technology and then received his Ph.D. in 1955 at the University of Chicago under Willard Libby. After serving on the faculty at Pennsylvania State University, he came to the National Bureau of Standards in 1962. In addition to chemometrics, his specialty has been atmospheric radioactivity, especially ^{37}Ar and ^{14}C . His research group pioneered the application of micro-radiocarbon measurements for the discrimination of anthropogenic and natural carbonaceous pollutants. He has held visiting faculty appointments at the Universities of Bern and Gent, and was a Commerce Science Fellow in the U.S. House of Representatives Science Committee and the office of Congressman Mike McCormack. He has served as a consultant or advisory panel member for NASA, NSF, IAEA, IUPAC, and other organizations. Currie is a Fellow of the American Institute of Chemists, holds Department of Commerce Gold and Silver Medals, and was named a NIST Fellow in 1994.

Prepared by Richard M. Lindstrom.

Bibliography

- [1] Lloyd A. Currie, Limits for Qualitative Detection and Quantitative Determination: Application to Radiochemistry, *Anal. Chem.* **40**, 586-593 (1968).
- [2] L. A. Currie, The Measurement of Environmental Levels of Rare Gas Nuclides and the Treatment of Very Low-Level Counting Data, *IEEE Trans. Nucl. Sci.* **NS19** (1), 119-126 (1972).
- [3] Lloyd A. Currie, The Many Dimensions of Detection in Chemical Analysis—with Special Emphasis on the One-Dimensional Calibration Curve, in *Trace Residue Analysis: Chemometric Estimations of Sampling, Amount, and Error*, David A. Kurtz (ed.), American Chemical Society, Washington, DC (1985), pp. 49-81.
- [4] Lloyd A. Currie, Detection: Overview of Historical, Societal, and Technical Issues, in *Detection in Analytical Chemistry (ACS Symp. Ser. 361)*, L. A. Currie (ed.), American Chemical Society, Washington, DC (1988) pp. 1-62.

- [5] Lloyd A. Currie, Nomenclature in Evaluation of Analytical Methods Including Detection and Quantification Capabilities, *Pure Appl. Chem.* **67**, 1699-1723 (1995).
- [6] Lloyd A. Currie, *Lower Limit of Detection: Definition and Elaboration of a Proposed Position for Radiological Effluent and Environmental Measurements* (Report NUREG/CR-4007), U.S. Nuclear Regulatory Commission, Washington, DC (1984).
- [7] L. A. Currie, International Recommendations Offered on Analytical Detection and Quantification Concepts and Nomenclature, *Anal. Chim. Acta* **391**, 103-134 (1999).
- [8] L. A. Currie, ch. 2 (Presentation of the Results of Chemical Analysis) and ch. 18 (Quality Assurance of Analytical Processes), in *IUPAC Compendium of Analytical Nomenclature*, János Inczédy, Tamás Lengyel, and A. M. Ure, eds., Blackwell Science, Oxford (1998).

Traceability: An Evolving Concept

The concept of traceability to national measurement standards has evolved considerably over the past 25 to 30 years. The 1980 paper, *Traceability: An Evolving Concept*, by Brian Belanger [1], is often cited by other authors writing on this subject. This paper and others by NBS/NIST authors have shown why the concept of traceability is not meaningful unless it incorporates quantified measurement uncertainty. Traditionally, measurement traceability has been described as an unbroken chain of comparisons to a primary or reference standard as maintained by a national measurement institute (NMI)—NIST or its counterpart institutions in other countries. The requirement that measurements be traceable to NIST or some other NMI was a response to needs for ensuring consistency among measurements made in different countries or domestic locations (e.g., a liter of gasoline in California should be the same as a liter of gasoline in New York), enabling interchangeability of parts, and facilitating industrial quality control.

The concept of establishing measurement standards and relating measurement results to those of a “higher authority” has been recognized for centuries. When the pyramids were built in Egypt, the length of the pharaoh’s forearm was defined as the cubit, and measurements made for its construction were based on that national standard of length. Today, we have fundamental principles of physics, rather than the pharaoh, to rely on for length standards, but the principle is the same—having national standards for key measurements upon which everyone agrees (ideally tracing to internationally agreed upon standards).

In 1962, the U.S. Department of Defense (DOD) impacted significantly on the evolution of traceability by requiring traceability for DOD laboratories, contractors, and subcontractors in MIL STD 45662A. All measuring and test equipment had to be calibrated utilizing reference standards whose calibration was certified as traceable to the National Bureau of Standards, had been derived from acceptable values of fundamental constants, or had been derived by the ratio type of self-calibration techniques. Reference standards used in the calibration of DOD equipment and systems had to be supported by certificates, reports, or data sheets attesting to the date, accuracy, and conditions under which the results were obtained. Although other U.S. government agencies established requirements



Fig. 1. Charles Ehrlich, Brian Belanger, Stanley Rasberry, and Ernest Garner (left to right).

for traceability to NBS, the requirements of MIL-STD-45662A were the most significant, since DOD was one of the largest purchasers of goods and services in the world.

During the 1970s, many organizations asked NBS for advice on how to comply with traceability requirements, since these requirements usually included language to have measurements “traceable to NBS.” Unfortunately, these agencies as well as industrial organizations included traceability requirements without considering the technical or scientific implications of traceability, or even having a consensus definition as to what it meant. As a result, there was confusion, misinformation, misinterpretation, and lack of agreement among the diverse and large community of

testing and/or calibration facilities, vendors, suppliers, and end-users of the products or services covered by the requirements of a contract or regulation.

Since contract auditors were not metrologists, they did not go beyond checking to see whether the contractor had calibration certificates from NBS on file. A paper trail tracing back to NBS primary or reference standards or SRMs can be of dubious value in ensuring that actual measurements are valid.

A story that may well be apocryphal was widely repeated to illustrate the shortcomings of the conventional view of traceability: There was a defense contractor that had a set of gage blocks calibrated by NIST at regular intervals and used the calibration certificates to prove to auditors that the company was “traceable to NBS” for its dimensional measurements. Allegedly, the company never opened or used the box of gage blocks. Each time the box returned to NBS for recalibration the seals were found unbroken. Auditors focused only on documentation for instruments or artifacts—not the entire measurement process. A measurement device might be properly calibrated and in good working order, but if the operator did not know how to use it properly, the resulting measurements could still be inaccurate.

Also during the 1960s and 1970s, internationally-renowned NBS statisticians Churchill Eisenhart, Harry Ku, and Joe Cameron taught that to have valid measurements, one must be able to quantify the random error (Type A), as well as put bounds on the maximum possible systematic errors (Type B) of the measurements, and to show that the total uncertainty is sufficiently small to accomplish the purpose at hand. The concept of the “Measurement Assurance Program,” or MAP, was developed during this era, and NBS worked with its customers to help them understand it. By the late 1970s, the clamor in both industry and government was increasing to define better what traceability meant. Within NBS, it was clear that unless measurement uncertainty is quantified and monitored, traceability is meaningless. The American Society for Testing and Materials, ASTM, was forming a new Committee E-46 on Quality Systems, and the topic of traceability was one of the items the committee was struggling with. Committee E-46 was looking to NBS to help define how traceability related to quality systems.

Brian Belanger, an electrical engineer, came to NIST in 1977 to work in the Institute for Basic Standards (IBS), then directed by Arthur McCoubrey. Shortly after Belanger arrived at NBS, Joe Cameron retired as Chief of the Office of Measurement Services, and Belanger was named to replace him. Cameron had introduced him to Eisenhart and Ku, and he quickly



Fig. 2. Joseph Cameron.

became an advocate for measurement assurance programs. Discussions with John Simpson, another NBS manager who was particularly articulate on the inadequacies of the conventional approach to traceability, also served to convince Belanger that things needed to change. Having read some earlier papers on traceability by Joe Cameron and Harmon Plumb [2-3], and with the encouragement of Art McCoubrey, Belanger set about to write an article on traceability for *ASTM Standardization News*.

The paper stressed that to be meaningful, traceability needed to evolve beyond an emphasis on auditing a paper trail and, instead, focus on whether the measurement process was in control with regard to random errors and drift, and whether the measurements had an acceptably small possible offset from national standards. In other words, the thrust of the paper was to insert the idea of measurement assurance into the traceability debate. The key concepts are that measurement uncertainty must be quantified relative to national standards and that data must be produced on a continuing basis to demonstrate that the measurement process is in a state of statistical control. Belanger recommended that traceability be defined as follows:

“Traceability to designated standards (national, international, or well-characterized reference standards based upon fundamental constants of nature) is an at tribute of some measurements. Measurements have traceability to the designated standards if and only if scientifically rigorous evidence is produced on a continuing basis to show that the measurement process is producing measurement results (data) for which the total measurement uncertainty relative to national or other designated standards is quantified.”

Full acceptance of the definition proposed by Belanger became an accomplished fact at NBS and, ultimately, at the NMI’s of other major industrial countries. Indeed, it is a necessary and essential condition that a world class NMI produce “scientifically rigorous evidence” on a continuing basis to show that its measurement processes are quantifiable and in a state of statistical control. At the other end of the measurement hierarchy—the manufacturer’s shop floor, small testing facilities, and calibration vendors—“scientifically rigorous evidence” and quantifiable uncertainty were more nearly perceived as a barrier to traceability and an unnecessary luxury. Even so, there was strong support for the concept within NBS and staff reinforced the message in their own writings and talks during the 1980s. By 1986, an American Society for Quality Control (ASQC) writing group had developed ANSI/ASQC Standard M1 on Calibration Systems, which included a definition of traceability based on the concept of quantified uncertainty.

As support for the new approach to traceability began to grow in the United States, metrologists in other countries gradually began to endorse the approach as well. In the 1993 edition of the International Vocabulary of Basic and General Terms in Metrology (VIM) traceability is defined as follows:

“Property of the result of a measurement or the value of a standard whereby it can be related to stated references, usually national or international standards, through an unbroken chain of comparisons all having stated uncertainties.”

While this definition does not explicitly embrace the concept of measurement assurance as a means of demonstrating that the measurement process is in a state of statistical control, it does embrace all of the other basic elements of the approach to traceability outlined in Belanger’s paper. The VIM definition has perhaps gained the widest acceptance on both the national and international scene of any definition of traceability published to date.



Fig. 3. Harmon Plumb.

Thinking on the subject continued to progress at NIST as well as elsewhere. In 1992 the Testing and Evaluation Committee of ASTM invited the Calibration Program to reflect on the decade of the 1980s and to give an assessment of new developments and trends in traceability. Ernest Garner and Stanley Rasberry of the Office of Measurement Services responded to the invitation with a paper [4], which was published in the ASTM Journal of Testing and Evaluation. Identifiable trends included: increased attention to defining and minimizing the number of measurement comparisons in the unbroken chain to NIST; local representation (i.e., intrinsic standards such as the Josephson Junction for voltage and the Quantum Hall Effect for resistance); greater use and acceptance of laboratory accreditation; significant movement to quality programs based upon internationally recognized documentary standards; and the emergence of multinational, regional trade organizations requiring improved mutual recognition, equivalency of measurements and confidence among accreditation and metrology bodies. The authors also called attention to the critical implications of transferring SI units from the point of realization (usually an NMI) to an end user, who then had to determine what uncertainty was required to satisfy the intended purpose.

Maintaining a measurement quality assurance system to ensure that total uncertainty was within specified limits at all times was recommended.

While the use of the concept of traceability was becoming more popular, its implementation was still less than ideal. During his years as Leader of the NIST Pressure Group in the late 1980s and early 1990s, Charles Ehrlich developed both an appreciation and frustration for the way that traceability was being treated in that field. He became increasingly concerned that while uncertainty in measurement was being recognized as an important component of traceability, the use of appropriate measurement assurance methods both before and after calibrations was not. Further, the community was taking different approaches to what constituted traceability, creating considerable confusion. In the mid-1990s Ehrlich teamed with Rasberry, who shared many of the same concerns, to move the traceability discussion ahead. Their collaboration produced the next and most recent contribution to this NBS/NIST traceability series, the paper *Metrological Timelines in Traceability* [5]. Besides appearing in the NIST Journal of Research, this paper was also published in the journal *Metrologia* and, by invitation, in the *Bulletin of the International Organization of Legal Metrology (OIML)*. Evidence of the continued interest in the metrology community of furthering the traceability concept came when this paper received the “best paper” award in the management category at the 1997 National Conference of Standards Laboratories Symposium.

The *Metrological Timelines* paper, which calls attention to the time element in controlling measurements (implied in the term “continuously” in Belanger’s paper), explains the modern view of traceability very thoroughly, and introduces the concept of the metrological timeline. Ehrlich and Rasberry emphasize that what is a valid “traceable” measurement today may not be valid at a later time unless the organization(s) in the unbroken chain have in place adequate measurement assurance procedures. They further emphasize that the responsibility for traceability resides not just with the NMI, but also with the lower level laboratory, which must put in place a process for guaranteeing that an instrument sent to an NMI for calibration is behaving the same way when it returns from the NMI as it did before it was sent. Ehrlich and Rasberry also elaborate on other aspects of traceability, such as multiple routes to traceability, equivalence of measurements, recalibration intervals and the use of intrinsic standards in traceability. They propose that the key questions to be answered concerning traceability are: “What corrections should be applied to a measurement result obtained at a given time with my instrument to match the result that would

be obtained using the instrument (standard) to which traceability is desired? What is the uncertainty of this corrected measurement result?” They also note that “An uncertainty cannot be stated rigorously without demonstrated traceability.”

Since traceability is an important ingredient of laboratory accreditation and international mutual recognition agreements, the importance of adopting a rigorous approach to traceability goes well beyond issues such as contractual compliance for defense contractors. Organizations such as NORAMET (The North American Metrology Cooperation), ISO, and OIML are using approaches that stress that quantified measurement uncertainty is a key aspect of traceability. While great progress has been made, traceability continues to evolve.

Brian C. Belanger holds a B.S. from Caltech and a Ph.D. from the University of Southern California, both in Electrical Engineering. After four years at the General Electric Research and Development Center, working in superconductivity, cryogenics, and high voltage dielectrics, he joined the Federal government in 1972, becoming a program manager at the Atomic Energy Commission (AEC), with responsibility for developing high capacity superconducting underground power cables. He joined NBS in 1977, soon becoming Chief of the Office of Measurement Services in the Institute for Basic Standards. Belanger served as NBS’ liaison to the Department of Defense (early 1980s), as Associate Director for Program Development in the Center for Electronics and Electrical Engineering (1987-90), as a Senior Technology Advisor to the Assistant Secretary for Technology Policy at the Commerce Department (1990), as the Deputy Director of the Advanced Technology Program (1991-98), and finally, as Executive Director of the NIST Visiting Committee on Advanced Technology.

Joseph M. Cameron received his B.S. in Mathematics in 1942 from the University of Akron and an M.S. in Statistics in 1947 from North Carolina State. He joined the NBS staff in 1947, and served as Chief of the Statistical Engineering Section in the NBS Applied Mathematics Division. In 1969 Cameron was appointed Chief of the newly formed Office of Measurement Services in the Institute for Basic Standards. He retired in 1977 and died in January 2000.

After completing his B.S. in Physics at the University of Miami and his Ph.D. in Surface Physics at the University of Pennsylvania, and working for five years in the semiconductor industry, Charles D. Ehrlich joined the Pressure and Vacuum Group at NBS/NIST in 1984, working to help establish the first leak calibration program. He served as Group Leader of the Pressure Group from 1987-1994, followed by two years in the

NIST Program Office. Ehrlich is currently Chief of the Technical Standards Activities Program.

Ernest L. Garner has a measurement background at NIST/NBS in high accuracy mass spectrometry of the elements to include atomic weight determinations, elemental abundance by isotope dilution, natural isotopic variations of the elements, and characterizing the sources of uncertainty in thermal ionization mass spectrometry.

Harmon H. Plumb received his B.A. in Physics from Middlebury College in 1947, and his M.S. and Ph.D. degrees from Northwestern University in 1948 and 1954, respectively. He joined the NBS Cryogenic Physics Laboratory in 1955, working to establish low temperature scales. Prior to joining NBS, Plumb performed basic research on ice single crystals for the Corps of Army Engineers, and from 1949 to 1950 he was a physics instructor at Miami University, Oxford, Ohio. He died in 1985.

Stanley D. Rasberry began his career at NIST in 1959, while studying for a degree in physics at the Johns Hopkins University. He developed and applied spectrometric techniques to the chemical analysis of a wide variety of materials, especially those intended as standard reference materials (SRMs). During the late 1960s, he was privileged to work with Joe Cameron to improve and computerize procedures for quantifying the homogeneity of candidate SRMs. The collaboration provided an appreciation that SRMs could serve as links for the traceability of chemical measurements to national standards. Later, Rasberry became Chief of the

Standard Reference Materials Program and subsequently Director of the Office of Measurement Services, where he also directed NIST efforts in standard reference data, weights and measures, calibration services, and the National Voluntary Laboratory Accreditation Program. The Measurement Services assignment gave him the opportunity to explore and develop traceability concepts together with Garner and Ehrlich. Following retirement, in 1997, Rasberry has continued to consult with NIST and has explored new modes of demonstrating traceability, including the use of proficiency testing with results being compared to those of an NMI.

Prepared by Brian Belanger, Stanley Rasberry, Ernest Garner, Carroll Brickencamp, and Charles Ehrlich.

Bibliography

- [1] Brian C. Belanger, Traceability: An Evolving Concept, *ASTM Stand. News* **8** (1), 22-28 (1980).
- [2] J. M. Cameron and H. Plumb, *Traceability—with Special Reference to Temperature Measurement, Society of Automotive Engineers*, Report 690428, National Air Transportation Meeting (1969).
- [3] Joseph M. Cameron, Traceability? *J. Qual. Technol.* **7**, 193-195 (1975).
- [4] Ernest L. Garner and Stanley D. Rasberry, What's New in Traceability, *J. Test. Eval.* **21**, 505-509 (1993).
- [5] Charles D. Ehrlich and Stanley D. Rasberry, Metrological Timelines in Traceability, *J. Res Natl. Inst. Stand. Technol.* **103**, 93-105 (1998).

Code for Information Interchange—ASCII

At the onset of the computing era, computers were designed and built with particular applications in mind. For example, SEAC, the Standards Electronic Automatic Computer, described elsewhere in this volume, was built at NBS in the late 1940s principally to handle certain classes of mathematical problems. SEAC had a manual keyboard for direct input, a teletype printer for direct output and punched paper tape for indirect operation. The idea of sharing the information from this computer with another computer was not one of the original concepts in the design. Very few computers were operational at the time, so such opportunities were greatly limited. Communication among humans was accomplished using the telephone, teletype, and typewriter, and these devices did not automatically lend themselves to machine-machine communication.

As computers became more common and areas of application increased, connecting computers to share the processing load or to share data became more important. SEAC and DYSEAC, for example, were connected at NBS in the 1950s. The electronic language of nearly all machines was, and continues to be, binary code, ones and zeros. Programmers encoded commands for the machines and data in binary code. Eventually higher level languages were developed so that commands were easier to write and debug. Alphabetic characters, numerals, and punctuation marks were needed to develop and use such higher-level languages. Each character had to be represented as some combination of binary digits. The problem was that different computers used different combinations of ones and zeros to represent the basic characters. This meant that an ‘a’ on one machine might have the same representation as an ‘m’ on another machine or, more commonly, a ‘<’ on one machine would be ‘!’ on another. A related problem occurred when one used computers to sort lists of alphanumeric data. In some code sets, letters preceded numerals, while in others the reverse was true. Since sorting algorithms treated the binary representations like numbers, a list sorted on one computer could differ in order from the same list sorted on another. The only way that commands or data could move from one computer to another and be interpreted correctly would be for all parties to agree on what each combination of ones and zeros stood for. Work on such a code for information interchange started in 1961. By 1967 the “7-bit coded character set” had evolved to include the letters of the alphabet, numbers and certain control

characters required by the computers for a total of 128 characters. Obtaining a consensus on this standard was not simple because several sets of codes developed by large computer vendors were already in widespread use. Control Data, for example, used the 6-bit FIELDDATA code, while IBM used the 8-bit EBCDIC. John L. Little, an NBS staff member from 1953 to 1987, held the positions of vice-chair and chair of X3.2.4, the national voluntary standards committee that developed the standard. X3.2.4 was chartered by the American Standards Association (ASA), which became the United States of America Standards Institute (USASI) in 1966, then the American National Standards Institute (ANSI) in 1969. Little worked for years to develop this standard. His strong, quiet, and deliberate way of working with members to obtain consensus was critical to the project’s success. In 1968, USASI published the 7-bit American Standard Code for Information Interchange (ASCII).

Most modern developments in the computer field, such as the Internet, would not have been possible without this underlying [ASCII] code.

NBS was interested in these standards efforts in the late 1960s because of new legislative directions. On October 30, 1965, the Brooks Bill (P.L. 89-306) authorized the Department of Commerce:

“(1) to provide scientific and technological advisory services to other agencies with regard to ADP equipment and related systems;

(2) to make appropriate recommendations to the President concerning the establishment of uniform Federal automatic data processing standards; and

(3) to undertake research in computer science and technology as needed to fulfill the above responsibilities.”

The Secretary of Commerce delegated the responsibility for implementing these provisions to the National Bureau of Standards. This legislative authority was augmented by Bureau of the Budget guidelines issued

in December 1966 that divided NBS work into five programmatic areas: advisory and consulting services, development of voluntary commercial standards, recommendations for uniform Federal standards, research on computer sciences and techniques, and computer service activities. Thus, research began in 1965 in the Center for Computer Sciences and Technology that would support voluntary national and international standards, and where appropriate be recommended for other agency use.

In November 1968, NBS sealed the fate of ASCII by adopting it as its first Federal Information Processing Standard (FIPS). This standard, published as FIPS Pub 1, *Code for Information Interchange* [1], and issued under the signature of President Lyndon Johnson, specified a code and character set for use in Federal information processing systems, communications systems, and associated equipment. The endorsement of the Federal government, then the largest purchaser of computer equipment, was probably the single most important reason for the subsequent wide adoption of ASCII. (Fig. 1)

In practice, the 7-bit ASCII code is often embedded in a comparable 8-bit code, where the leftmost bit is set to zero. This is convenient because most computers transfer information in units of 8 bits (a “byte”). In some cases, the leftmost bit is used as a parity bit. In

“even” parity, for example, the leftmost bit is set so that the number of 1 bits is always even. This allows for automatic 1-bit error detection, a useful feature when transmission lines are noisy.

ASCII might well be called the first computer interoperability standard. Most modern developments in the computer field, such as the Internet, would not be possible without this underlying code. To this day, all data interchanges start and end as sets of ASCII characters. When all else fails, systems still will accept “plain text files” which are coded in ASCII. ASCII has turned out to be an excellent code that has lasted for over 30 years, and has been fundamental to the development of the U.S. computer industry.

Prepared by Martha M. Gray.

Bibliography

- [1] *Code for Information Interchange*, Federal Information Processing Standards Publication (FIPS Pub) 1, National Bureau of Standards, Washington, DC, November 1, 1968.
- [2] Charles E. Mackenzie, *Coded Character Sets: History and Development*, Addison-Wesley Publishing Co., Reading, MA (1980).
- [3] *Brooks Bill Issue Study of the National Bureau of Standards*, NBS Report 10 608, Center for Computer Sciences and Technology, National Bureau of Standards, Washington, DC, September 1971.

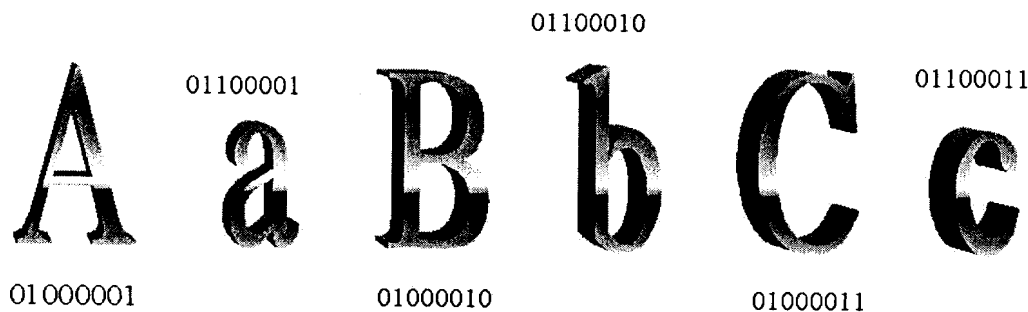

Fig.1. The first letters of the alphabet with their ASCII equivalents, as given in FIPS PUB 1.

Consumer Information Series

The many thousands of papers produced by NIST/NBS in the past century have mainly been technical in nature, directed to an audience of research scientists and engineers. Some, of course, were issued in a form more readily understandable to a wider audience, but were focused on groups of individuals with a particular interest in the subject matter. It is roughly estimated, however, that only a tiny percentage of our publications were written specifically with the consuming public in mind in order to make technical results generally available for their practical value to all citizens. The utility of these publications aimed at the general public is attested by the fact that hundreds of thousands of them were ordered by keenly interested consumers.

One of the earliest example of a publication designed for the public at large was the 1922 Circular [1] on constructing a radio, described elsewhere in this volume. In the following years, especially during the 1930s and 1940s, the Bureau had occasion to conduct tests of various types of material and then made selected reports available from the Government Printing Office at low cost. Many of these [2-9] had limited audiences, but a few [10, 11, 12] had broad appeal to homeowners and potential homebuyers. *Thus How to Own Your Own Home* [11] sold 300,000 copies in 1923, and *Care and Repair of the Home* [12], which drew fire from private sector business interests, sold more than 500,000 copies between 1931 and 1940.

The early 1970s saw an explosion of consumer activism in the United States, leading to the establishment of such Federal agencies as the Consumer Product Safety Commission (CPSC). In response to a Presidential order, the Bureau formed a Center for Consumer Product Technology (CCPT) with divisions for product engineering, product systems analysis, product safety, and law enforcement standards—and with a dedicated mission to provide useful information to the general public. Guides in the Consumer Information Series (CIS) [13-22] were prepared by Bureau experts and CCPT staff. These booklets were distributed in very large numbers and at very low cost through the Government Printing Office and by the Consumer Information Center in Pueblo, Colorado. (Fig. 1)

A special foreword in each publication, by the NBS Director, called attention to technological changes that affect products and the marketplace; the confusion that stems from the proliferation of products and materials

about which the shopper has little useful information; and the availability of results from the technical work that should be shared with the citizens who, after all, support the Bureau's work with their taxes.

The first Guide in the Series, NBS CIS1 *Fibers and Fabrics* [13], provided a detailed account of both natural (i.e., cotton, linen, silk, and wool) and 16 man-made fibers, describing for each material its properties, uses, and appropriate care. It also discussed blends and combinations, as well as the features of wash-and-wear fabrics. The information was presented in a form to facilitate user selection of fabrics that would satisfy personal needs and desires. In addition, the laundering or dry-cleaning recommendations and the susceptibility of some fabrics to flammability or application of excessive heat were probably of equally great value. A glossary defined the terms used to describe the manufacturing processes and attributes of the cited materials, and a table of trademarks of commercial synthetic materials, obtained from listings of the Federal Trade Commission, aided shoppers when encountering generic fabrics otherwise identified only by trade names.

How to Own Your Own Home sold 300,000 copies in 1923, and *Care and Repair of the Home*, which drew fire from private sector business interests, sold more than 500,000 copies.

Tires—Their Selection and Care [14] gave the automobile owner or driver a well-illustrated tutorial on the kinds (not brands) of tires available and how they should be chosen and maintained for optimum safety, efficiency, and cost savings. In addition to describing tire care and tire construction and features, the Guide addressed the factors that should influence tire selection, plus driving habits and effects that depend on the chosen tires and their care. Moreover, the publication pointed out that there was then no reliable system for grading tires in terms of *quality*, a situation that still prevails.

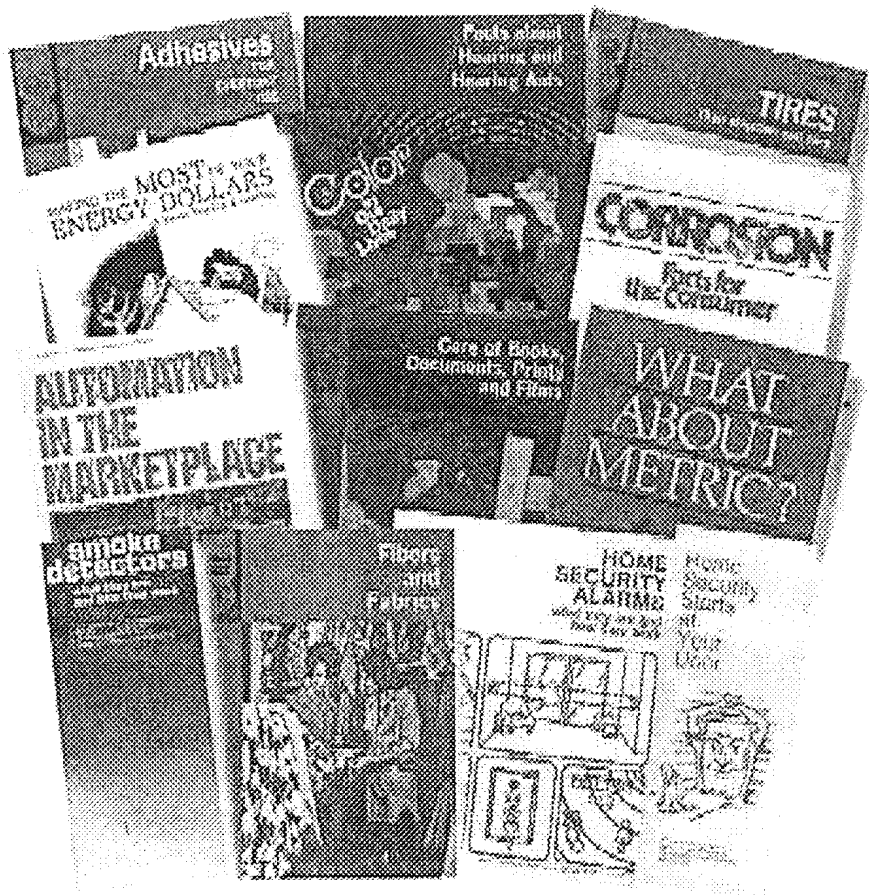

Fig. 1. Covers of booklets in the Consumer Information Series and other typical pamphlets intended for use by homeowners.

Information needed for selecting and applying adhesives for use in the home and hobby shop was made available in *Adhesives for Everyday Use* [15]. This practical guide described the different types of adhesives and their characteristics, along with typical applications for the various materials that are to be bonded and the end use of the application. It also illustrated and outlined the steps that should be taken when preparing the materials, applying the adhesives, and ensuring a strong bond.

Facts About Hearing and Hearing Aids [16] was prepared by NBS specialists in sound and testing, with assistance from a number of other agencies concerned with audiology (the science of measuring hearing capability) and the medical aspects of hearing and its loss. It gave a comprehensive description of the hearing process, the causes and treatment of hearing loss, and steps that might be taken to compensate for such loss, including the availability of well-described types of hearing aids then on the market. The guide offered suggestions on how to select a hearing aid, how to use it, and proper maintenance and care.

Based on Bureau research on paper and photographic film, *Care of Books, Documents, Prints and Films* [17] explained the composition and kinds of paper, and preservation techniques. It covered the nature of books and documents, the factors that degrade them over the course of time, and recommended methods of caring for them, as well as techniques for making minor repairs, letting professional restorers carry out major repairs and restoration of damaged books and documents. This guide also offered a short section on the appropriate care for photographic films, negatives, and prints.

A beautifully illustrated (in color, of course!) guide, *Color in our Daily Lives* [18], was one of the most popular publications in this series; it was distributed to classrooms across the country and to the general public. In easily readable textbook fashion, color was related to light, and families of color hues were shown for each of red, green, blue, and yellow. Similarly, there were illustrations of families of dark, light, vivid, and grayish colors; relationships among different colors with respect to hues, lightness, and vividness; and the influence on perception of colors when juxtaposed with other colors.

Color harmony, the use of colors by individuals (for cosmetics or apparel) or in various environments, and suggestions for experimentation were other topics included in the guide.

Starting in 1973, when *What About Metric?* [19] was published, the Bureau began a long, continuing campaign to acquaint the public with the decimal-based metric system, which was then being adopted by the rest of the world; more recent examples from the metric program are described elsewhere in this volume. The CIS Guide explained why metric was being adopted in almost all countries; the differences between customary (such as inches and pounds) measurements and those in the metric system (e.g., meters and grams); and how to convert from one system to the other.

The energy crisis of the early 1970s had a major impact on consumers as a result of fuel shortages and increasing fuel costs. Homeowners and renters were influenced to turn down thermostats and to wear extra clothing in the house, while at the same time considering longer term techniques for maintaining comfortable living conditions yet simultaneously saving money. *Making the Most of Your Energy Dollars* [20] presented information on the value of increasing different types of home insulation and the economic and climatic factors that should be considered in determining whether and how much to invest for these purposes. The guide offered sample worksheets for background calculations and referred readers to several available “How To” publications.

Corrosion of metal, which exacts a heavy economic toll on consumers and the nation, has long been a subject of study at NBS/NIST. Useful advice was therefore put together for the guide entitled *Corrosion—Facts for the Consumer* [21]. This publication described the different types of corrosion, how to prevent or minimize it, where it occurs most frequently around the home and the automobile, how to remove corrosion when it occurs, and what protection techniques to look for when buying metal objects.

By the end of NBS/NIST’s first century, almost everyone had become aware of and was gaining the benefits from bar code scanning, automated teller machines, and other now-commonplace reliance on computerization in daily life. However, in 1978 these “magical” systems were mysterious to most folks, but were explained to the public in the guide entitled *Automation in the Marketplace* [22]. Simple language described the Universal Product Code and the use of laser bar code scanners and electronic cash registers connected to computers. It set forth the advantages to consumers of automated systems installed in groceries,

retail stores, and banks, and alluded to NBS research in encryption to protect privacy and ensure security.

The foregoing summaries reflect not only a small subset of the institution’s broad research programs, but also the impact that the results can have on the knowledge base for the citizenry. In particular, these publications—as well as small brochures such as those for smoke detectors, home security, and home security alarms [23-25]—contained information that could be used immediately by all readers for practical purposes. Although the Consumer Information Series no longer exists *per se*, similar information is still provided to the general public through various releases to mass media and resultant publicity.

The NBS authors whose CIS guides are listed in the bibliographic citations that follow evidence the wide range of technical talent characteristic of the NBS/NIST staff during its first century. Josephine M. Blandford was a senior NBS textile technologist responsible for research on evaluation and quality control of textile materials and apparel components, with two books published by the Apparel Research Foundation, Inc. F. Cecil Brenner, was a fiber scientist who served as Chief of the NBS Textile and Apparel Technology Center, then as the Tire Systems Division Chief at the National Highway Transportation Safety Administration’s Safety Research Laboratory, and later a consultant to the Environmental Protection Agency. He developed the government standard for tire safety and performance.

Karl F. Plitt was Chief of the Product Engineering Section, responsible for testing and research into safety and performance characteristics of products used by fire and law enforcement officials and the consuming public, including adhesives, plastics used for safety goggles and helmets, and children’s toys. Edith L. R. Corliss, trained in physics, performed research in electricity, optics, and astronomy before becoming an expert in acoustics, measurement of hearing, and speech communications systems. William K. Wilson, a chemist, was Chief of the Paper Evaluation Section for 15 years, then a guest worker at the National Archives. [J. L. Gear was on the staff of the National Archives.]

Deane B. Judd, trained as a mathematician and physicist, was Assistant Chief of the Optics and Metrology Division and in charge of the Bureau’s colorimetric work. His many awards included gold medals from the Department of Commerce and the Illuminating Engineering Society and recognition by the Society of Motion Picture Engineers, the Inter-Society Color Council, and the Optical Society of America. Louis E. Barbrow, a physicist who served as Chief of the Photometry and Colorimetry Section and Chief of the Optics Metrology Branch, later coordinated metric activities

at NBS and served as a consultant to the National Conference on Weights and Measures.

Madeleine Jacobs, a chemist who later became Editor-in-Chief of the American Chemical Society's *Chemical & Engineering News*, served in the NBS Office of Information Activities and was later Director of Public Affairs at the Smithsonian Institution. Stephen Peterson was an economist who conducted extensive research in the area of building economics.

Jerome Kruger, Chief of the Corrosion Section of the Metallurgy Division, was a chemist whose research work led to receipt of Silver and Gold Medals from the Department of Commerce, the NBS Samuel Wesley Stratton Award, as well as awards from the National Association of Corrosion Engineers, the British Institute of Corrosion, and the Electrochemical Society. Shirley Radack, a Supervisory Computer Specialist, managed program coordination and support activities for the Institute of Computer Science and Technology (ICST) at NBS and was responsible for review and approval of Federal Information Processing Standards and for outreach activities with the public and private sectors. Grace Burns was a special assistant to the Director of ICST.

Prepared by Walter G. Leight and W. Reeves Tilley.

Bibliography

- [1] *Construction and Operation of a Simple Homemade Radio Receiving Outfit*, Circular of the Bureau of Standards, No. 120, U.S. Government Printing Office, Washington, DC (1922).
- [2] Hubert R. Snoke and Braxton E. Gallup, Accelerated Weathering Tests of Mineral-Surfaced Asphalt Shingles, *J. Res. Natl. Bur. Stand.* **18**, 669-681 (1937).
- [3] Irvine C. Gardner, *Charts for Testing Lens Resolution*, NBS Miscellaneous Publication M166, National Bureau of Standards, U.S. Government Printing Office, Washington, DC (1940).
- [4] *Sun Lamps, Health Lamps; Carbon and Mercury Arc Lamps*, Letter Circular LC 631, National Bureau of Standards, Washington, DC, February 12, 1941.
- [5] *Painting of Steam and Hot Water Radiators*, Letter Circular LC 445, National Bureau of Standards, Washington, DC, July 19, 1935.
- [6] *Corrosion of Metals Used in House Construction*, Technical Information on Building Materials 1 (TIBM 1), National Bureau of Standards, Washington, DC, March 3, 1936.
- [7] Donald B. Brooks and Ronald E. Streets, *Automotive Antifreezes*, National Bureau of Standards Circular 474, U.S. Government Printing Office, Washington, DC (1948).
- [8] *Automobile Engine Lubricating Oils*, Letter Circular LC 613, National Bureau of Standards, Washington, DC (Revised to September 15, 1940).
- [9] F. W. Smither, *Washing, Cleaning, and Polishing Materials*, Circular of the National Bureau of Standards C 424, U.S. Government Printing Office, Washington, DC (1939).
- [10] *Safety for the Household*, Circular of the National Bureau of Standards, No. 397, U.S. Government Printing Office, Washington, DC (1932).
- [11] John M. Gries and James S. Taylor, *How to Own Your Home: A Handbook for Prospective Home Owners*, Building and Housing Publication BH 17, National Bureau of Standards, U.S. Government Printing Office, Washington, DC (1931).
- [12] Vincent B. Phelan, *Care and Repair of the Home Including Minor Improvements*, Building and Housing Publication BH 15, National Bureau of Standards, U.S. Government Printing Office, Washington, DC (1931).
- [13] Josephine M. Blandford and Lois M. Gurel, *Fibers and Fabrics*, NBS Consumer Information Series 1 (CIS 1), National Bureau of Standards, Washington, DC, November 1970.
- [14] F. C. Brenner, *Tires, Their Selection and Care*, NBS Consumer Information Series 2 (CIS 2), National Bureau of Standards, Washington, DC, November 1970.
- [15] Karl F. Plitt, *Adhesives for Everyday Use*, NBS Consumer Information Series 3 (CIS 3), National Bureau of Standards, Washington, DC, November 1970.
- [16] Edith Corliss, *Facts About Hearing and Hearing Aids*, NBS Consumer Information Series 4 (CIS 4), National Bureau of Standards, Washington, DC, November 1971.
- [17] William K. Wilson and James L. Gear, *Care of Books, Documents, Prints and Films*, NBS Consumer Information Series 5 (CIS 5), National Bureau of Standards, Washington, DC, December 1971.
- [18] Deane B. Judd, *Color in Our Daily Lives*, NBS Consumer Information Series 6 (CIS 6), National Bureau of Standards, Washington, DC, March 1975.
- [19] Louis E. Barbrow, *What About Metric*, NBS Consumer Information Series 7 (CIS 7), National Bureau of Standards, Washington, DC, October 1973.
- [20] Madeleine Jacobs and Stephen R. Peterson, *Making the Most of Your Energy Dollars in Home Heating and Cooling*, NBS Consumer Information Series 8 (CIS 8), National Bureau of Standards, Washington, DC, June 1975.
- [21] Jerome Kruger, *Corrosion—Facts for the Consumer*, NBS Consumer Information Series 9 (CIS 9), National Bureau of Standards, Washington, DC, March 1978.
- [22] Shirley M. Radack and Grace G. Burns, *Automation in the Marketplace*, NBS Consumer Information Series 10 (CIS 10), National Bureau of Standards, Washington, DC, March 1978.
- [23] *Smoke Detectors, What They Are and How They Work*, LC 1074, National Bureau of Standards, Washington, DC, December 1976.
- [24] *Home Security Starts at Your Door*, LC 1088, National Bureau of Standards, Washington, DC, January 1976.
- [25] *Home Security Alarms—What They Are and How They Work*, LC 1079, National Bureau of Standards, Washington, DC, March 1977.

Theory of Isoperibol Calorimetry for Laser Power and Energy Measurement

This paper [1] describes the first and most thorough analysis concerning the behavior of isoperibol calorimeters developed at NIST and used by NIST (and other laboratories) as standards for laser power and energy measurements. For over 30 years, instruments based on the principles described in the paper have been used as primary standards to relate absorbed laser energy to dissipated electrical energy and thus to provide traceability to SI units. A family of such instruments provides the basis for calibrations that span a wide range of laser types and power ranges—wavelengths from 193 nm in the ultraviolet to 10.6 μm in the infrared, and power levels from nanowatts to over 100 kW. New instruments based on the same principles continue to be developed as NIST capabilities are extended to meet emerging needs. In some cases (e.g., certain wavelengths or power levels), NIST is the only national metrology laboratory with the capability to provide needed laser calibrations, and, consequently, it provides traceability to organizations throughout the world.

Lasers, as opposed to other sources of electromagnetic radiation, typically emit light in a well-defined beam that may have very high irradiance and a non-uniform irradiance profile. Laser light also has very high spatial and temporal coherence. Although these properties contribute to the usefulness of lasers for many applications, they also can complicate the performance of accurate measurements of laser power and energy.

In the early 1960s, during the period of initial development of the laser, NBS began developing standards and appropriate measurement techniques to characterize laser radiation. The very first NBS laser energy standard was a “liquid cell calorimeter” developed by Don Jennings [2]. It used an aqueous solution of CuSO_4 , contained in a cell with a quartz window to absorb the radiation from pulsed lasers such as ruby and Nd:glass. A small amount of dark ink was added to the solution to increase the wavelength absorption range. Thermocouples were used to measure the corresponding temperature increase from laser light absorption. An electrical heater, immersed in the liquid, provided a means to calibrate the responsivity of the device electrically. Although designed for measuring the energy from pulsed lasers, the liquid-cell calorimeters also worked well for measuring the energy or average power from continuous (cw, as opposed to pulsed) laser

sources. For a number of years, these liquid-cell calorimeters were used as primary standards at NIST and at military primary standards laboratories for calibrating laser power and energy meters.

In July of 1969, Dale West, Chief of the Heat Measurements Section of the Heat Division, who had been working for a number of years in the field of high-temperature calorimetry, moved from NBS in Gaithersburg to NBS in Boulder to join Don Jennings’ Quantum Electronics Section of the Quantum Electronics Division. As leader of the Laser Power and Energy Project, West applied his knowledge of “bomb calorimetry” (a technique for measuring the energy released by a combustion reaction that produces a large increase in temperature and pressure) to the task of measuring the amount of power and energy contained in laser radiation. He quickly recognized that isoperibol calorimeters would make excellent primary standards for this application and would allow increased accuracy over the liquid-cell calorimeters in use at that time. The term “isoperibol” refers to a calorimeter in a constant temperature environment. In 1970, West and Kenneth Churney wrote and published *Theory of Isoperibol Calorimetry for Laser Power and Energy Measurements* [1] in which they developed the underlying concepts for isoperibol laser calorimetry. Thereafter, until his retirement in 1974, West designed and built various models of laser calorimeters that implemented the principles established in this paper. He also published numerous other papers in which he discussed various aspects of laser power and energy measurements.

In this seminal paper [1], West and Churney start with the first law of thermodynamics and, in a logical sequence, develop the equations that govern the resulting thermal response of an isoperibol calorimeter when exposed to laser radiation. They clearly explain the assumptions and conclusions that lead to their final formula for the “corrected temperature rise” of the calorimeter. West and Churney showed that the corrected rise is proportional to the stored thermal energy in the calorimeter minus the heat energy lost during the measurement. In further papers, West gives more detailed guidance (and even a software program [3]) that enables the reader to apply the corrected-rise calculations to actual data acquisition and analysis. These analytic techniques are still used today for many situations in laser-measurement laboratories. The clear

and thorough treatment of the calorimeter behavior enabled timely and widespread public acceptance of these devices as primary standards for laser energy measurements.

West was known for his rigorous, meticulous approach to metrology and uncertainty analysis. Before building any final devices, he built numerous test fixtures and samples to evaluate thoroughly the heat-flow patterns, with special emphasis on the equivalence of electrical and laser energy deposition. The isoperibol calorimeters that West designed for laser measurements basically consist of cylindrically shaped absorbing cavities surrounded or enclosed by temperature-controlled metal jackets. The jackets provide the isoperibol (i.e., constant temperature environment) conditions necessary as prescribed in the paper. During use, laser radiation enters the absorbing cavity (typically coated with a black paint or other highly absorbing material) where the absorbed optical energy is converted to thermal energy. The resulting temperature increase is then monitored with thermal sensors (e.g., thermocouples or resistors). Heater wires are thermally attached to the cavities to calibrate the instruments by injection of known amounts of electrical energy. Using West and Churney's equations

developed in the paper, the characteristic output of the temperature sensors can then be quantitatively correlated with the measured amount of injected electrical energy.

The first significant calorimeter that West produced based on these principles was the C-series calorimeter [4,5], which was designed to measure the output of low to medium power (1 mW–1 W) lasers. Assisted by William Case and Alvin Rasmussen for certain aspects of the construction, such as the temperature control circuitry and the electrical wiring, West did much of the construction at his desk (e.g., attaching the thermocouples and positioning the cavity inside the temperature-controlled jacket). The calorimeter worked amazingly well and its output reproduced the characteristic behavior pattern predicted in the paper. The C-series calorimeters are still used on a daily basis over 30 years later. A cross-section of this calorimeter design is shown Fig. 1.

To accommodate higher powers (up to 1000 W), West then designed and built several larger calorimeters, designated as the K-series [6]. The absorbing cavities for these calorimeters used cone-shaped mirrors to spread the laser radiation over a large area of the absorbing surface to reduce the irradiance and thus

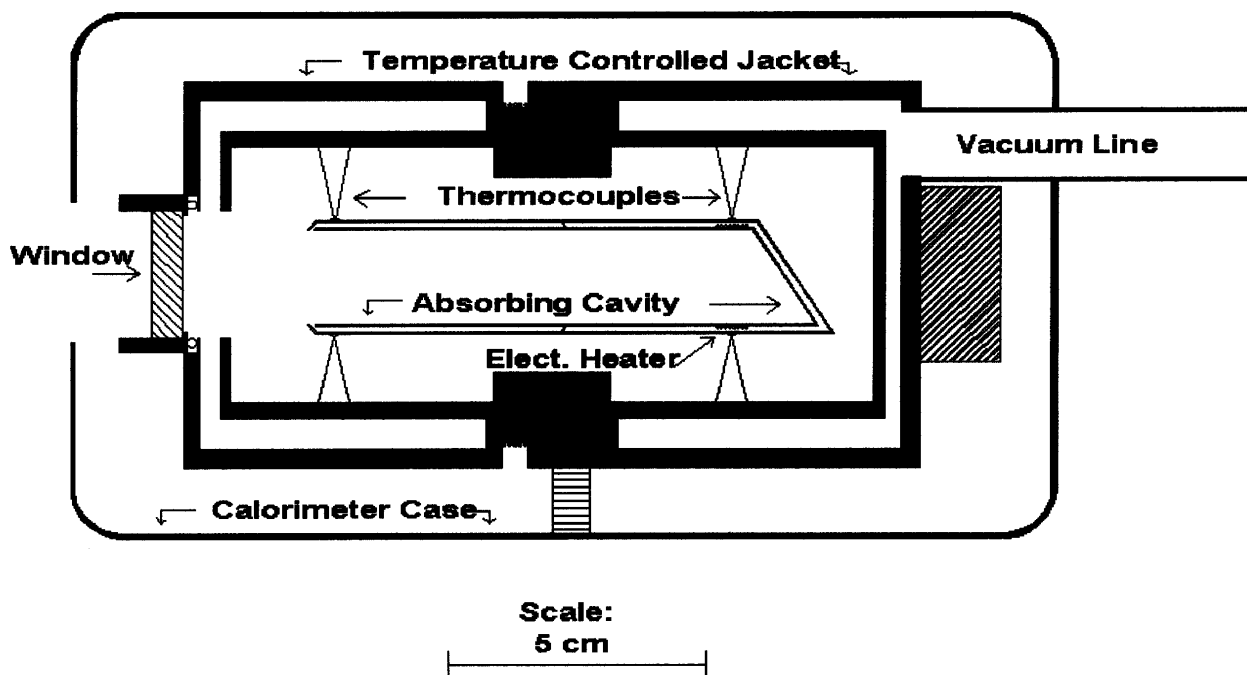

Fig. 1. Cross-section of C-series isoperibol laser calorimeter.

prevent damage of the absorbing paint. At about this same time (i.e., early 1970s), Douglas L. Franzen and Leonard Schmidt, with West's technical oversight and advice, designed and built a type of isoperibol calorimeter called the Q-series [7] to measure pulsed laser radiation. As with Jennings' liquid cell calorimeter, the Q-series devices use a volume absorbing technique to distribute the absorbed energy throughout the absorbing material. In particular, Franzen used neutral-density absorbing glass having specific absorption coefficients to absorb safely the pulsed laser radiation of Q-switched Nd:YAG lasers. Then, in the mid-1970s, two large (400 kg) calorimeters, called the BB-series [8,9], were built by Richard Smith, George Chamberlain, and Phillip Simpson to measure military lasers having powers up to 100 kW (cw). Although these large, massive calorimeters were inherently different from the earlier, smaller calorimeters in many respects, their outputs are, nevertheless, governed by the isoperibol-calorimeter equations developed in West and Churney's paper.

More recently, Rod Leonhardt, Chris Cromer, Marla Dowell, T. R. Scott, and David Livigni have developed specific models of isoperibol calorimeters for measuring the pulsed, ultraviolet radiation emitted by excimer lasers [10,11]. The inherently high photon energies and large peak powers of these lasers complicate accurate measurement, which is one reason why no other national laboratories have such capability at this time. The NIST calorimeter cavities contain specially selected glass which can absorb the radiation without suffering damage or degradation while keeping fluorescence to a minimum. Again, analysis of the calorimeter output uses the algorithms developed in West and Churney's papers. For special high-accuracy laser-power measurements at low power or energy levels, many national metrology laboratories, including the NIST Optoelectronics Division [12], now use cryogenic radiometers to compare laser power to electrical power with very low associated uncertainties (<0.01 %). At cryogenic temperatures, the thermal properties (such as specific heat capacity and thermal conductivity) of the metal cavity change rapidly with temperature; consequently, the temperature response is not sufficiently linear to apply West's isoperibol calorimeter principles. However, the essential structure of these devices in many ways mirrors the basic construction of West's original C-series calorimeter (i.e., a cylindrical cavity surrounded by a constant temperature environment and having an electrical heater attached).

Today, 30 years later, West and Churney's corrected-rise equation and associated isoperibol-calorimeter analysis described in this paper still permeate the field of laser power and energy measurements. The array of calorimeters described above, whose behaviors are governed by the principles discussed in the paper, are still in operation, many on a daily basis. In addition, almost all standard calorimeters for measuring laser power and most radiometers (even those that are not isoperibol) are designed using the same basic structure of West's C-series, his first isoperibol calorimeter.

Prepared by Thomas R. Scott.

Bibliography

- [1] E. D. West and K. L. Churney, Theory of Isoperibol Calorimetry for Laser Power and Energy Measurements, *J. Appl. Phys.* **41**, 2705-2712 (1970).
- [2] D. A. Jennings, Calorimetric Measurement of Pulsed Laser Output Energy, *IEEE Trans. Instrum. Meas.* **IM-15**, 161-164 (1966).
- [3] E. D. West, *Data Analysis for Isoperibol Laser Calorimetry*, NBS Technical Note 396, National Bureau of Standards, Boulder, CO, February 1971.
- [4] E. D. West, W. E. Case, A. L. Rasmussen, and L. B. Schmidt, A Reference Calorimeter for Laser Energy Measurements, *J. Res. Natl. Bur. Stand.* **76A**, 13-26 (1972).
- [5] E. D. West and W. E. Case, Current Status of NBS Low-Power Laser Energy Measurement, in *Conference on Precision Electromagnetic Measurements*, Jul 1-5, 1974, London, England, *IEEE Trans. Instrum. Meas.* **IM-23**, 422-425 (1974).
- [6] E. D. West and L. B. Schmidt, *A System for Calibrating Laser Power Meters for the Range 5-1000 W*, NBS Technical Note 685, National Bureau of Standards, Boulder, CO, May 1977.
- [7] D. L. Franzen and L. B. Schmidt, Absolute Reference Calorimeter for Measuring High Power Laser Pulses, *Appl. Opt.* **15**, 3115-3122 (1976).
- [8] Richard L. Smith, Thomas W. Russell, William E. Case, and Alvin L. Rasmussen, A calorimeter for high-power CW lasers, *IEEE Trans. Instrum. Meas.* **IM-21**, 434-438 (1972).
- [9] George E. Chamberlain, Philip A. Simpson, and Richard L. Smith, Improvements in a Calorimeter for High-Power CW Lasers, *IEEE Trans. Instrum. Meas.* **IM-27**, 81-86 (1978).
- [10] Rodney W. Leonhardt, *Calibration Service for Laser Power and Energy at 248 nm*, NIST Technical Note 1394, National Institute of Standards and Technology, Boulder, CO, January 1998.
- [11] M. L. Dowell, C. L. Cromer, R. W. Leonhardt, and T. R. Scott, Deep Ultraviolet (DUV) Laser Metrology for Semiconductor Photolithography, in *Characterization and Metrology for ULSI Technology: 1998 International Conference*, March, 1998, American Institute of Physics, Woodbury, New York (1998) pp. 539-541.
- [12] D. J. Livigni, C. L. Cromer, T. R. Scott, B. C. Johnson, and Z. M. Zhang, Thermal characterization of a cryogenic radiometer and comparison with a laser calorimeter, *Metrologia* **35**, 819-827 (1998).

Influence of Water on Crack Growth in Glass

As early as the 1920s, the strength of glass and other brittle materials was understood to be limited by the presence of small cracks. Under stress, the small cracks would grow into larger cracks until reaching a critical size, at which point the material would fracture catastrophically. It also was well known that humid environments reduced the strength more severely than did dry environments. Furthermore, a glass loaded at a stress below its ultimate strength did not show infinite life, but rather failed without warning after some finite time. Understanding the nature of this “delayed failure” had become a vital issue for industries that wanted, and perhaps needed, to use glass as an engineering material. This was the setting in which Sheldon Wiederhorn, newly arrived at the Bureau after a short stint at DuPont, began his research into the growth of cracks in glass. In two papers, the first in 1967 [1] and the second in 1970 [2], Wiederhorn became the first to quantify crack growth rates using fracture mechanics techniques that were only just then emerging as a means of analyzing crack phenomena. In doing so, he laid the foundation for understanding the environmentally enhanced fracture of all brittle materials.

Wiederhorn’s work was the culmination of a sequence of advances that occurred over a period of approximately 120 years. In the mid-1890s, Brodmann [3] conducted experiments on the strength of glass and found that specimens whose surfaces were etched in HF solution were significantly stronger than specimens tested without etching. That result provided the first reported evidence that glass fails from surface defects. The next major advance occurred in 1920 when Griffith [4] established unequivocally that glass fails from surface flaws and that the strength of glass is determined by the density and severity of such flaws. More than two decades passed before Orowan [5] clearly asserted that the relevant surface energy of fracture should be a function of the environment in which it is measured. Gurney [6] then showed that moisture enhanced fracture could be explained in terms of thermodynamic concepts. Stuart and Anderson [7] subsequently extended those ideas to model delayed failure using chemical rate theory. In that same time frame (although unknown to Wiederhorn until after his 1967 paper), Irwin [8] and Irwin and Kies [9] were advancing the analytical concepts of fracture mechanics and their application to brittle materials. These experimental and theoretical advances formed a convergent timeline in Wiederhorn’s papers of 1967 and 1970.

The critical feature in Wiederhorn’s work was the direct observation of a growing crack. Prior to Wiederhorn’s study, all research into delayed failure had been conducted by measuring the times to failure and only inferring the extension of microscopic cracks. Although others had observed the subcritical growth of macroscopic cracks, Wiederhorn was the first to quantify their growth rates. He used a diamond stylus to scratch the surface of a glass specimen and then observed the growth of the crack through a microscope while the specimen was being stressed. Using a double cantilever beam specimen, he applied a constant load to the ends of the slide and made crack velocity measurements using a traveling microscope and a filar eyepiece.

Wiederhorn’s study established several characteristics of the effect of water vapor on crack motion in glass at room temperature (see Fig. 1). Wiederhorn observed that his results could be separated into three qualitatively different regions indicating three distinct mechanisms controlling crack growth: (I) a slow growth region in which the crack velocity depended exponentially on the load; (II) a plateau region in which crack growth was limited by the diffusion rate of water to the crack tip; and (III) a region in which crack growth was rapid and

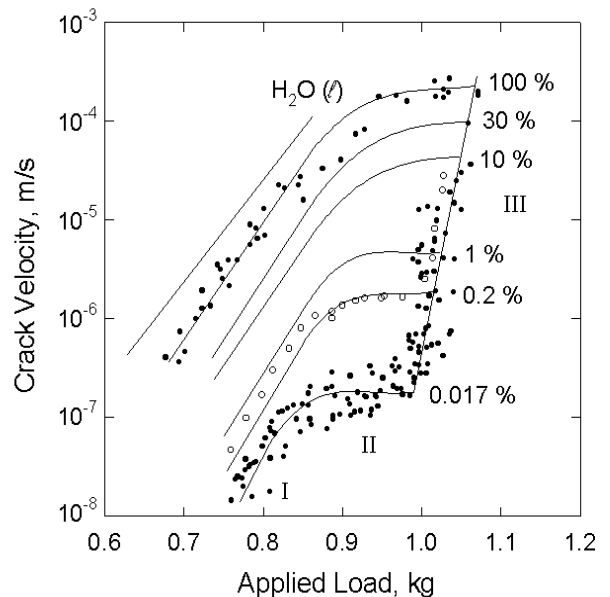

Fig. 1. The effect of water vapor on crack motion in glass at room temperature for relative humidity ranging from 0.017 % to 100 %.

independent of the amount of water in the environment. The data of region I were in complete accord with the static fatigue theory put forward previously by Charles and Hillig [10] which indicated that water vapor produced a corrosive attack on the glass at the crack tip. Wiederhorn reasoned that this corrosive attack continued into region II, but the plateau occurred because the crack extension could not proceed any faster than was allowed by the diffusion rate of water to the crack tip. In region III, the crack velocity was independent of water vapor. Later, Wiederhorn *et al.* [11-13] showed that the dielectric properties of the environment controlled crack growth in region III.

The fracture mechanics formalism he adopted in these two papers captured the dependence of the growth rate on the size of the crack and the stress. Wiederhorn also showed the crack growth rate depended on humidity in accord with an existing theory of delayed failure in glass. These two contributions demonstrated that the delayed failure did indeed result from the subcritical growth of cracks, and put the prediction of glass lifetime under load on a solid theoretical foundation.

This work influenced the scientific and engineering community in two ways. First, it illustrated the power of fracture mechanics as a tool for investigating the fracture behavior of ceramics. Shortly after the publication of Ref. [1], a host of other groups launched fracture mechanics studies of brittle failure of ceramics. Second, engineers used the method of quantifying crack growth to develop new techniques for assuring the reliability of structural ceramics. Both of these themes became important fields of research in ceramics. The recognition of the importance of the environment at the crack-tip to crack growth led to a series of studies [11,12,13] of crack growth rate in electrolytes as a function of zeta potential, ionicity, and pH. Of these, only pH was critical in establishing the relationship between crack velocity and stress intensity factor. These studies showed that ion exchange between the electrolyte and the glass at the crack tip determined the crack tip pH and consequently the relationship between crack velocity and stress intensity factor.

In those works and others, Sheldon M. Wiederhorn has researched the mechanisms of fracture in glasses and brittle ceramics for more than 35 years. He joined the Physical Properties Section of the Inorganic Solids Division at NBS in 1963. Recently, his work has led him to investigate the creep and creep rupture of structural ceramics. The Department of Commerce recognized his accomplishments in awarding him both the Silver Medal



Fig. 2. Sheldon Wiederhorn, 1964.

(1970) and the Gold Medal (1982), in addition to the NBS Samuel Wesley Stratton Award (1977) for his work in brittle fracture. The American Ceramic Society (ACerS) independently recognized his work, awarding him the Ross Coffin Purdy Award (1971), the Morey Award (1977), and the John Jeppson Award (1994). ACerS further elected him a Fellow (1970) and named him a Distinguished Life Member (1999). In 1985, he was chosen by ACerS to present the distinguished Sosman Lecture, on the subject of subcritical crack growth in glass, at the Annual Meeting of the American Ceramic Society. In 1991 he was elected a member of the National Academy of Engineering. He has held various positions of administrative responsibility at NIST (Section Chief, Division Chief, and Group Leader), and is now a Senior NIST Fellow in the Materials Science and Engineering Laboratory.

Prepared by Edwin Fuller, William Luecke, and Stephen Freiman.

Bibliography

- [1] S. M. Wiederhorn, Influence of Water Vapor on Crack Propagation in Soda-Lime Glass, *J. Am. Ceram. Soc.* **50**, 407-414 (1967).
- [2] S. M. Wiederhorn and L. H. Bolz, Stress Corrosion and Static Fatigue of Glass, *J. Am. Ceram. Soc.* **53**, 543-548 (1970).
- [3] C. Brodmann, Einige Beobachtungen über die Festigkeit von Glasstäben, Vorgelegt von W. Voigt in der Sitzung **3**, 1894.
- [4] A. A. Griffith, The Phenomena of Rupture and Flow in Solids, *Philos. Trans. R. Soc. London, Ser. A* **221**, 163-198 (1920).
- [5] E. Orowan, The Fatigue of Glass Under Stress, *Nature* **154**, 341-343 (1944).
- [6] C. Gurney, Delayed Fracture in Glass, *Proc. Phys. Soc., London* **59**, 169-185 (1947).
- [7] Derald A. Stuart and Orson L. Anderson, Dependence of Ultimate Strength of Glass Under Constant Load on Temperature, Ambient Atmosphere, and Time, *J. Am. Ceram. Soc.* **36**, 416-424 (1953).
- [8] George Irwin, Fracture Dynamics, in *Fracturing of Metals*, American Society for Metals, Cleveland, Ohio (1948) pp. 147-166.
- [9] G. R. Irwin and J. A. Kies, Critical Energy Rate Analysis of Fracture Strength, *Weld. J.* **33**, Welding Research Supplement, 193-s-198-s (1954).
- [10] R. J. Charles and W. B. Hillig, in *Symposium on Mechanical Strength of Glass and Ways of Improving It*, Florence, Italy, September 25-29, 1961, Union Scientifique Continentale du Verre, Charleroi, Belgium (1962) pp. 511-527.
- [11] S. M. Wiederhorn and H. Johnson, Effect of Electrolyte pH on Crack Propagation in Glass, *J. Am. Ceram. Soc.* **56**, 192-197 (1973).
- [12] S. M. Wiederhorn and H. Johnson, Influence of Sodium-Hydrogen Ion Exchange on Crack Propagation in Soda-Lime Silicate Glass, *J. Am. Ceram. Soc.* **56**, 108-109 (1973).
- [13] S. M. Wiederhorn, S. W. Freiman, E. R. Fuller, Jr., and C. J. Simmons, Effects of Water and Other Dielectrics on Crack Growth, *J. Mater. Sci.* **17**, 3460-3478 (1982).

Phase Equilibria Diagrams

When the American Ceramic Society celebrated its own centennial review in 1998 [1], the NIST/ACerS publication of phase diagrams was cited as one of the two most important accomplishments of the Society affecting the worldwide development and application of ceramics. Working together, NIST and ACerS have published more than 20 000 phase diagrams. (Fig. 1)

Phase diagrams are graphical representations of the regions of distinct chemical and structural behavior of materials in thermodynamic equilibrium. The regions are defined by the composition of the material and by the measurement conditions. Most importantly for ceramics industries, the diagrams are constructed as a function of composition and temperature. The properties of a material, and thus its functionality, often depend critically on what region is used in the preparation of the material. Often, the processing conditions must be maintained in very narrow regions of temperature and composition in order to achieve a material with a desired property. Phase diagram data were essential, for example, in the development of a durable material now used worldwide in more than 500 million catalytic converters to control emissions from cars and trucks. Thus phase diagrams are not only vital to understanding the behavior of ceramics and metal alloys; they are also essential for manufacturing the materials reproducibly, effectively, and economically.

The NIST/ACerS collaboration on phase diagrams can be traced back to the year 1933 when F. P. Hall (Pass and Seymour, Inc., Syracuse, New York) and Herbert Insley (NBS) published a compilation of 178 diagrams in the *Journal of the American Ceramic Society* [2]. These authors published a supplement to this collection in 1938 [3] and then revised and extended the entire compilation in 1947 [4], at which time the collection contained 507 diagrams. A further supplement was compiled and published by Howard McMurdie (NBS) and Hall in 1949 [5]. By 1964, the need and growing demand for reliable phase equilibria diagrams was abundantly clear, and the collaboration between NIST and ACerS began in earnest with the founding of *Phase Diagrams for Ceramists* as a separate publication series [6]. The first volume, published without a volume number, was prepared by Ernest M. Levin, Carl R. Robbins, and Howard McMurdie as a revision and expansion of the previous compilations. The 1964 edition contained 2066 diagrams. Since that time, the series has expanded to twelve regular volumes, three

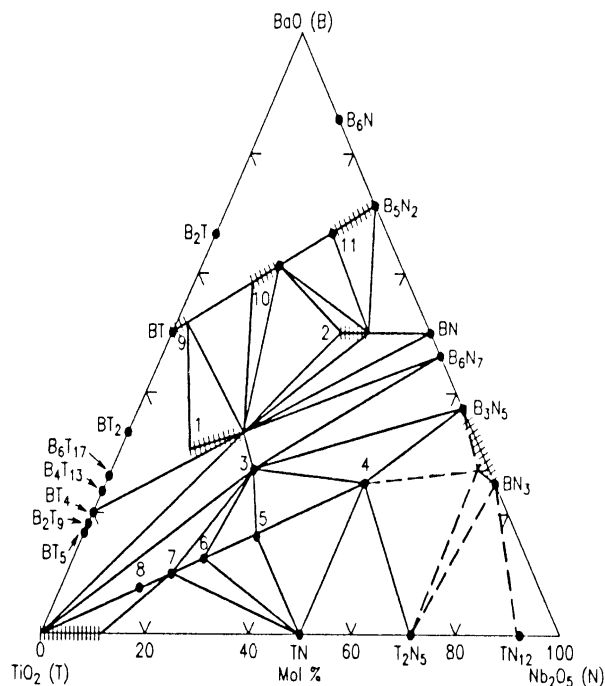

Fig. 1. Diagram #9529 from Volume XI. The phase diagram for the BaO-TiO₂-Nb₂O₅ system determined at NBS by R. S. Roth and his colleagues has provided key data for understanding and processing barium titanate dielectric ceramics important for wireless communications technology.

volume supplements, and three special monographs. In the process of this expansion, the series acquired a much broader scope than was originally anticipated. To reflect that broader scope more accurately, the name of the series was changed to *Phase Equilibria Diagrams*. Also, in keeping with advancing technology, a computerized version of the collection was developed for use on personal computers. Today, the compilations encompass systems containing oxides; salts; semiconductor elements; borides, carbides, and nitrides for structural ceramics; high-temperature superconductors; and systems containing a mix of these compounds. More than 45000 copies of individual volumes have been sold to ceramic industries, research laboratories, and academic libraries.

The sustained success of the series beyond the initial volumes has been due in part to the contributions of numerous distinguished individuals who have served in various editorial capacities. An acknowledgment of the General Editors for the published volumes is given in

Table	
Vol.	General Editors
VIII	
I	E. M. Levin, C. R. Robins, and H. F. McMurdie
II	E. M. Levin, C. R. Robins, and H. F. McMurdie
III	E. M. Levin and H. F. McMurdie
IV	R. S. Roth, T. Negas, and L. P. Cook
V	R. S. Roth, T. Negas, and L. P. Cook
VI	R. S. Roth, J. R. Dennis, and H. F. McMurdie
VII	L. P. Cook and H. F. McMurdie
VIII	B. O. Mysen (Geophysical Laboratory)
IX	G. B. Stringfellow (U. Utah)
X	A. E. McHale (Consultant)
XI	R. S. Roth
XII	A. E. McHale and R. S. Roth
A91*	A. E. McHale
A92*	A. E. McHale
A93*	A. E. McHale
M1#	J. D. Whitler and R. S. Roth
M2#	T. A. Vanderah, R. S. Roth, and H. F. McMurdie
M3#	H. M. Ondik and H. F. McMurdie
* A: Annual Supplements	
# M: Monographs of Special Topics	
1: Phase Diagrams for High Tc Superconductors	
2: Superconductors II	
3: Phase Diagrams for Zirconium and Zirconia Systems	

the table. In addition to the General Editors, the production of a single volume also involves associate editors, managing editors, text editors, and editorial assistants. Among the outstanding efforts of the individuals who have served in these capacities are the exceptional contributions of McMurdie (since the inception of the series) and Robert S. Roth (for both editorial and experimental work since Vol. IV). Helen M. Ondik (since Vol. VI) has been especially noted for her meticulous attention to details. She was awarded the Department of Commerce Silver Medal in 1971 and was appointed to a Department of Commerce Science and Technology Fellowship for 1976–1977. Mary A. Clevinger (since Vol. IV) has been a mainstay in numerous aspects of the project, including editing, coordination, and layout. The project is now under the general management of Terrell A. Vanderah, under whose leadership the project staff is undertaking a complete modernization to a computerized desktop publishing system and an internet-ready electronic database.

No list of individuals who have made outstanding contributions to this work is complete without naming Peter K. Schenck and Carla G. Messina. These two individuals were responsible for creating the computer-controlled operations that produced Volume VI and all the succeeding volumes. Peter Schenck's programs for digitizing and plotting phase diagrams (both on-screen and for hard copy) have been compared to other

graphics programs by outside graphics experts and have been found to be unequalled. For his outstanding work, he received the Department of Commerce Bronze Medal in 1981.



Fig. 2. Howard McMurdie, 1961.

Howard McMurdie has been involved with the series since its inception. McMurdie began his long association with NIST/NBS when he accepted a position in the Lime and Gypsum Section of the Clay and Mineral Products Division of NBS in April 1928. During the early years in this position, he took a course, taught by Herbert Insley, on the use of the petrographic microscope. That contact proved important later when Insley established the Petrographic Laboratory in the Glass Section of NBS in 1935 and selected McMurdie as his assistant. Insley left NBS about 1944 to take a position at the Pennsylvania State University, but their paths were to cross again about 1947 when Insley returned to NBS as director of the Ceramic Division. Insley selected McMurdie as Chief of the Constitution and Microstructure Section, which later became the Crystallographic Section. McMurdie pursued the study of phase diagrams

in that position up to his official retirement in 1966, at which time he became a research associate at NBS; he has been associated with the phase diagram program continuously since that time, a career spanning more than 70 years!



Fig. 3. Robert Roth, 1961.

Robert Roth received his Ph.D. in geology from the University of Illinois in 1951, whereupon he joined the staff at NBS. From the beginning, his work has been dedicated to the discovery of new materials, revealing the existence of phase relations and investigating the structural nature of ceramic compounds. His second publication, of approximately 200 over his career, was entitled “Piezoelectric Properties of Lead Zirconate-Lead Titanate Solid Solution Ceramics.” That material, now commonly known as PZT, is one of the most important advanced electronic ceramic materials known to this day, with applications as diverse as providing the spark in charcoal grills and gas stoves to positioning mirrors in giant telescopes. His particular interest in the

phase equilibria relations of the oxides of titanium, niobium, and tantalum has resulted in his outstanding contributions to the field of dielectric ceramics. His work in the 1970s on the exploration of the barium titanate systems, and his phase diagrams of those systems, played a critical role in their subsequent commercialization in cellular base stations. He also played a large role in the development of barium neodymium titanate and zirconium tin titanate. All of these ceramics are still the materials of choice as low-loss dielectric resonators at microwave frequencies. In recent years, his effort to elaborate the complex phase diagrams of ceramic copper oxide superconductors is credited with providing the standards upon which many research groups base their processing of the important superconducting material $Ba_2YCu_3O_7$. For his exceptional research activities and his tireless efforts as senior editor of numerous volumes of *Phase Diagrams for Ceramists and Phase Equilibria Diagrams*, he has received numerous awards, including the Department of Commerce Silver Medal, NBS Special Service Award for Meritorious Publication, the Department of Commerce Gold Medal, the Sosman Memorial Lecturer Award (American Ceramic Society), and the John Jeppson Award (American Ceramic Society). He has been elected Fellow of the Mineralogical Society of America, the Geological Society of America, and the American Ceramic Society. He retired from NIST in 1991.

Outside support for the phase equilibria program has been strong, with respect to both technical contributions to the work and the financial commitment necessary to maintain the program. Indeed, the American Ceramic Society made an appeal to its industrial members to contribute to a fund, which ACerS administers yet today, specifically to support the program. Industry and individuals responded with contributions that have amounted to nearly 2.5 million dollars [1]. Those funds are used to support ACerS staff who work at the NIST Gaithersburg facility directly in collaboration with NIST staff.

An independent assessment of the NIST/ACerS phase equilibria program was conducted by TASC, Inc. in 1997 [7]. Their assessment concluded that without the dedicated NIST/ACerS program, the ceramics industry would incur substantial costs for internal research and experimentation and would experience significant delays in introducing innovative ceramic materials to their markets. In their conservative estimate, TASC, Inc. found that the NIST/ACerS program has a remarkable benefit-to-cost ratio of approximately 10 to 1.

Today, the phase diagrams published by the NIST/ACerS program are proving to be vital to the development of emerging technologies. For example, carefully determined phase stability regions are essential for improving the manufacture of bulk superconducting-wires and tapes. Advanced ceramics with high dielectric constant, low dielectric loss, and reliable temperature stability are needed to improve the performance and to lower the cost of the components of cellular communications circuits. To meet these needs and others, current work includes studies of materials used in a variety of areas such as high temperature superconductors, wireless communications, electronic packaging, fuel cells, and sensors.

Prepared by Ronald Munro, Howard McMurdie, Helen Ondik, and Terrell Vanderah.

Bibliography

- [1] Robert Butler, Samantha Adams, and Meghan Humphreys, *The American Ceramic Society: 100 Years*, The American Ceramic Society, Columbus, Ohio (1998), pp. 3, 119-120.
- [2] F. P. Hall and Herbert Insley, A Compilation of Phase-Rule Diagrams of Interest to the Ceramist and Silicate Technologist, *J. Am. Ceram. Soc.* **16**, 455-567 (1933).
- [3] F. P. Hall and Herbert Insley, Supplement to "A Compilation of Phase-Rule Diagrams of Interest to the Ceramist and Silicate Technologist," *J. Am. Ceram. Soc.* **21**, 113-164 (1938).
- [4] F. P. Hall and Herbert Insley, Phase Diagrams for Ceramists, *J. Am. Ceram. Soc.* **30**, Part II, 1-152 (1947).
- [5] Howard F. McMurdie and F. P. Hall, Phase Diagrams for Ceramists: Supplement No. 1, *J. Am. Ceram. Soc.* **32**, Part II, 154-164 (1949).
- [6] Ernest M. Levin, Carl R. Robbins, and Howard F. McMurdie, *Phase Diagrams for Ceramists*, The American Ceramic Society, Columbus, Ohio (1964).
- [7] Michael L. Marx, Albert N. Link, and John T. Scott, *Economic Assessment of the NIST Ceramic Phase Diagram Program*, Planning Report 98-3, TASC, Inc., Arlington, Virginia (1998).

Determination of Reduced Cells in Crystallography

In theory, physical crystals can be represented by idealized mathematical lattices. Under appropriate conditions, these representations can be used for a variety of purposes, such as identifying, classifying, and understanding the physical properties of materials. Critical to these applications is the ability to construct a unique representation of the lattice. The vital link that enabled this theory to be realized in practice was provided by the 1970 paper of A. Santoro and A. D. Mighell, *Determination of Reduced Cells* [1]. This seminal paper led to a mathematical approach to lattice analysis initially based on a systematic reduction procedure and the use of standard cells. Subsequently, the process evolved to a matrix approach based on group theory and linear algebra, which offered a more abstract and powerful way to look at lattices and their properties.

In the early 1960s, the Crystal Data Center at NBS started to build a database with chemical and crystallographic information on all classes of materials, including inorganics, organics, minerals, and metals. An immediate challenge was to organize the information in a systematic manner so that database users could readily determine material relationships. For example, one might wish to identify an unknown material by comparing its structure with structures already in the database. But this is not as simple as it might seem. The following anecdote illustrates the nature of the problem.

On an archaeological expedition, two colleagues were analyzing patterned designs on the walls of ancient buildings. They noted that by simply translating a small piece, or unit, of the design, one could create the entire pattern. Each researcher independently searched the archaeological site, selected a favorite design, and drew a repeat unit (a unit cell) on a notepad to take home. Later in their hotel, the colleagues carefully compared their repeat units. Finding them to be quite different in appearance, they concluded that their repeat units defined different wall patterns. Upon returning home, they used the repeat units to recreate the wall patterns on their computers. To their surprise, the two wall designs were identical.

What happened? Why were they tricked into thinking that they had two patterns when in reality their unit cells described only one? The answer is illustrated by the simple example of a 2-dimensional lattice in Fig. 1. Since there are no terminal edges in the idealized lattice, the entire array of dots can be generated by

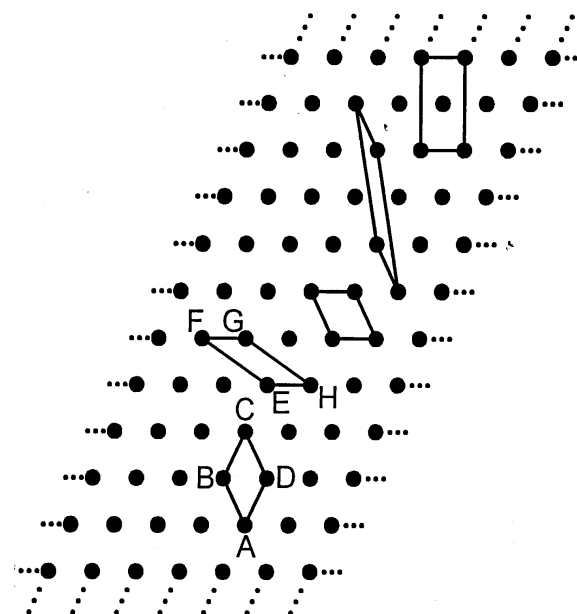

Fig. 1. An infinite variety of unit cells, vastly different in appearance and specification, can generate the same mathematical lattice.

translating the small rhombus of dots labeled A, B, C, D. Here, translating means moving the unit cell right, left, up, and down, where “right and left” are defined as movements parallel to the direction AD, while “up and down” are defined by the direction AB. However, notice that the skewed parallelogram labeled E,F,G,H can be translated to generate exactly the same array of dots. In this case, “right and left” are defined as movements parallel to the direction EH, while “up and down” are defined by direction EF. At first glance, these two unit cells neither look the same nor translate in the same way, yet the readily apparent differences between a rhombus and a skewed parallelogram cannot be observed in the infinite lattices that they generate.

Exactly the same problem exists in describing the idealized lattice of a physical crystal. In this case, instead of a 2-dimensional planar wall pattern designed by man, we have a 3-dimensional crystal (e.g., a mineral such as an emerald, a ruby, or a diamond) designed by nature. Like the wall pattern which can be created by translating a 2-dimensional unit cell (a parallelogram), a crystal lattice can be created using a 3-dimensional building block (a parallelepiped), as illustrated in Fig 2.

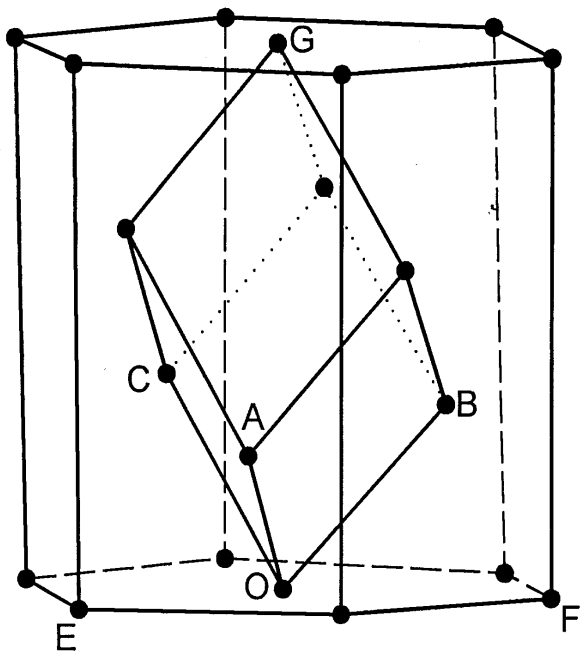

Fig. 2. The rhombohedral unit cell (with axes OA,OB,OC) and the larger hexagonal cell (with axes OE,OF,OG) define the same three-dimensional mathematical lattice.

This figure shows the case of a crystal with rhombohedral unit cell (parameters $a = 10.0 \text{ \AA}$, $\alpha = 55.0^\circ$), and the equally correct alternative hexagonal cell (with $a = 9.235 \text{ \AA}$ and $c = 25.38 \text{ \AA}$). Either cell when translated will generate the same crystal lattice.

More generally, the parallelepiped of the unit cell may be defined abstractly by three noncoplanar vectors a, b, c . However, to achieve the full utility of theory and practice, everyone must end up with the same a, b, c even though alternative parallelepipeds might be constructed with equal validity. The problem is that the equivalence of alternative parallelepipeds is not so readily established that computerized search routines could easily recognize two alternatives as being equivalent. Because there are infinite varieties of alternative cells, Santoro and Mighell chose to pursue the development of a procedure that would arrive at a unique representation.

The first step toward a unique representation was to recognize that any lattice could be defined on the basis of a cell with the smallest possible volume (known as a primitive cell). But for a given lattice, which of the many possible primitive cells should be selected? Some four decades earlier, Niggli [2] had considered this aspect of cell definition and had defined what was termed a reduced cell which turned out to be a unique cell. What remained to be established was the mathematical theory and associated algorithms for calculating

the reduced cell starting from any cell of the lattice. It was this practical realization of reduced cells that was achieved in the 1970 paper of Santoro and Mighell.

For a cell to be reduced, two sets of conditions, termed the main and special conditions for reduction, must be satisfied. The main conditions ensure that one has selected a cell based on the three shortest vectors of the lattice. The special conditions ensure that one has determined a unique cell for those cases in which the lattice has more than one cell with the same shortest three vectors. Based on the theory in the 1970 paper, algorithms were designed and software written that could be applied universally to any cell ever published or determined in the laboratory.

Application of the reduced cell to both the database work and the laboratory research at NIST was immediately successful. For example, reduction played a central role in the determination of the crystal structure of benzene II, a high-pressure polymorph of benzene that requires a pressure of about 1.2 GPa to stabilize. Using the NIST high-pressure diamond anvil cell (DAC), which is described elsewhere in this volume, benzene II became the first crystal structure determined *in situ* by high-pressure single crystal x-ray diffraction techniques [3]. Because of its narrow aperture, the diffraction data from the DAC were highly restricted. There was, however, a sufficient amount of data to determine the reduced cell for the specimen and to establish unambiguously that the crystal system was monoclinic. Other techniques, which required more extensive data, would have failed in this task.

In routine structure determination work, reduction became a practical tool for analyzing difficult cases in which traditional visual methods often failed. This was especially true for a rhombohedral crystal, where it is hard to find the right orientation to see the 3-fold symmetry. As a result, the structure determination for such a crystal was difficult and often incorrect. So extreme was the frustration level that it was said, in jest, that the best thing that could happen would be for the crystal to fall off the instrument and disappear in a crack in the floor. Reduction procedures, however, instantly resolved the difficulty, and the resulting highly characteristic reduced cell and form [4] immediately led the experimentalists to the correct answer.

Additional successes derived directly from the uniqueness property of the reduced cell, because it leads directly to a general method for materials characterization. By classifying all materials using the reduced cell, one obtains the basis for a powerful method for compound identification [5,7]. In this scheme, a unit cell of an unknown is transformed to the reduced cell, which is then matched against the file of known materials represented by their respective reduced cells.

Combining the reduced cell match with an element type match further enhances the selectivity. In practice, cell matching has proved an extremely practical and reliable technique to identify materials. Today this identification strategy is widely used, as it has been integrated into commercial x-ray diffractometers [8].

Due somewhat to serendipity, the most significant and lasting value of this work is probably not reduction itself. Rather, reduction has played a key transition role in helping to move the rather conservative discipline of crystallography in new directions with new insights. The research on reduction proved that there are excellent reasons for looking at the crystal lattice from an entirely different point of view. Consequently, with time, many other lattice-related papers followed, including papers on sublattices and superlattices, composite lattices, and coincidence site lattices. At NIST, the mathematical analysis of lattices was pursued further and evolved to a matrix approach that offered a more abstract and powerful way to look at lattices and their properties.

The matrix approach, in particular, has many applications, including for example, symmetry determination [6,7]. In sharp contrast to other methods that focus on the consequences of symmetry (such as dot products, d -spacings, etc.), the matrix approach deals with symmetry in its most abstract form, represented as matrices. The basis of the matrix approach is to generate the matrices that transform the lattice into itself. The resulting set of matrices comprise a mathematical group obeying the formal relations of group theory. These matrices may be used both theoretically and practically to analyze symmetry from any cell of the lattice. In this formulation, the mathematics and algorithms used to analyze symmetry become extremely simple since they are based on manipulating integers and simple rational numbers using elementary linear algebra. The matrix approach, therefore, provides both the conceptual and practical framework required in performing the experimental procedures in a logical and general manner.

The ability to determine a unique reduced cell and the subsequent achievements in lattice analysis, especially the matrix approach, have been critical milestones in

crystallography. They established an important mathematical rigor in crystallography and in the materials sciences and have stimulated many practical applications.

Antonio Santoro is a current member of the NIST Center for Neutron Research. His primary interests are the determination of crystal structures from neutron powder diffraction data and the application of the bond valence method to structural distortions.

Alan Mighell retired from NIST in 1998, after leading the Crystal Data Center for many years. Currently, he is a guest research scientist in the Materials Science and Engineering Laboratory at NIST. His principal research interests include the design and development of procedures for materials identification and for establishing lattice relationships.

Prepared by Alan D. Mighell, Vicky Lynn Karen, and Ronald Munro.

Bibliography

- [1] A. Santoro and A. D. Mighell, Determination of Reduced Cells, *Acta Crystallogr.* **A26**, 124-127 (1970).
- [2] P. Niggli, Krystallographische und Strukturtheoretische Grundbegriffe, *Handbuch der Experimentalphysik*, Vol.7, part 1, Akademische Verlagsgesellschaft, Leipzig (1928).
- [3] G. J. Piermarini, A. D. Mighell, C. E. Weir, and S. Block, Crystal Structure of Benzene II at 25 Kilobars, *Science* **165**, 1250-1255 (1969).
- [4] A. D. Mighell, A. Santoro, and J. D. H. Donnay, Reduced-cells section, *International Tables for X-ray Crystallography*, Vol. 1, 530-535 (1952).
- [5] A. D. Mighell, The Reduced Cell: Its Use in the Identification of Crystalline Materials, *J. Appl. Crystallogr.* **9**, 491-498 (1976).
- [6] Vicky L. Himes and Alan D. Mighell, A Matrix Approach to Symmetry, *Acta Crystallogr.* **A43**, 375-384 (1987).
- [7] Vicky L. Karen and Alan D. Mighell, *Apparatus and Methods for Identifying and Comparing Lattice Structures and Determining Lattice Structure Symmetries*, U.S. Patents 5,168,457 and 5,235,523 (1992, 1993).
- [8] Susan K. Byram, Charles F. Campana, James Fait, and Robert A. Sparks, Using NIST Crystal Data Within Siemens Software for Four-Circle and SMART CCD Diffractometers, *J. Res. Natl. Inst. Stand. Technol.* **101**, 295-300 (1996).

Speed of Light From Direct Frequency and Wavelength Measurements

The National Bureau of Standards has had a long history of interest in the speed of light, and no doubt this interest contributed to the measurement described here [1]. As early as 1907, Rosa and Dorsey [2] determined the speed of light from the ratio of the capacitance of a condenser as measured in electrostatic and electromagnetic units. Over the ensuing years NBS developed still other methods to improve upon the accuracy of this important physical constant.

By the late 1960s, lasers stabilized in frequency to atomic and molecular resonances were becoming reliable research tools. These could be viewed as providing stable reference for either optical frequency or wavelength. This duality of frequency and length produced the obvious suggestion that a simultaneous measurement of frequency and length for the same laser transition would yield a very good measurement of the speed of light. In fact, a 1958 measurement of the speed of light by Froome [3] was done by determining the frequency and wavelength of a microwave source at 72 GHz. The frequency measurement was fairly straightforward, since frequency in the microwave and lower ranges can be readily measured with great accuracy. The speed-of-light measurement was limited primarily by the difficulty in measuring the very long wavelength (about 0.4 cm) of the 72 GHz radiation. Clearly, a better measurement would result if higher frequencies could be employed, where wavelengths could be more accurately measured. The measurement technology of that era was not up to the task. The wavelength of visible radiation could be measured fairly well, but no accurate methods for measuring visible frequencies were available. Whereas frequency could be measured quite well in the microwave to millimeter-wave region, wavelength measurements were problematic.

The measurement of the speed of light by the Boulder group involved the development of a new method. The approach taken was to synthesize signals at progressively higher and higher frequency using harmonic-generation-and-mixing (heterodyne) methods and to lock the frequency of a nearby oscillator or laser to the frequency of this synthesized signal [4]. Photodiodes, as well as metal-insulator-metal diodes, fabricated by adjusting a finely tipped tungsten wire against a naturally oxidized nickel plate, were used for harmonic

generation and mixing. With this approach, a frequency-synthesis chain was constructed linking the microwave output of the cesium frequency standard to the optical region, so that the group could directly measure the frequency of a helium-neon laser stabilized against the 3.39 μm transition of methane. When the measurements were completed, the uncertainty limitation was found to be the asymmetry of the krypton line on which the definition of the meter was then based. The experiment thus showed that the realization of the meter could be substantially improved through redefinition.

This careful measurement resulted in a reduction of the uncertainty of the speed of light by a factor of nearly 100. The methods developed at NIST were replicated in a number of other laboratories, and the experiments were repeated and improved to the point where it was generally agreed that this technology could form the basis for a new definition of the meter. An important remaining task was the accurate measurement of still-higher (visible) frequencies which could then serve as more practical realizations of the proposed new definition. The Boulder group again took the lead and provided the first direct measurement of the frequency of the 633 nm line of the iodine-stabilized helium-neon laser [4], as well as a measurement of the frequency of the 576 nm line in iodine [5]. These measurements, and similar measurements made at other laboratories around the world, were the last ingredients needed to take up the redefinition of the meter.

The new definition of the meter, accepted by the 17th *Conférence Générale des Poids et Mesures* in 1983, was quite simple and elegant: "The metre is the length of the path traveled by light in vacuum during a time interval of $1/299\,792\,458$ of a second." A consequence of this definition is that the speed of light is now a defined constant, not to be measured again. NBS had played a key role in pioneering measurement methods that resulted in this redefinition and in the optical frequency measurements that contributed to practical realizations of the definition. In subsequent years, measurement of other stabilized-laser systems added to the ways in which the meter could be realized. This way of defining the meter has proven to be particularly robust, since unlike a definition based on a standard such as the krypton lamp, length measurement can be continuously improved without resorting to a new definition.



Fig. 1. Winners of the Gold Medal from the Department of Commerce for their measurement of the speed-of-light. Shown left to right in front are Ken Evenson (project leader), Bruce Danielson and Gordon Day and in back left to right are Dick Barger, John Hall, Russ Petersen, and Joe Wells.

The measurement methods developed at NBS during this period also led to the development of high-resolution spectroscopic methods utilizing tunable frequency sources in the optical region [7,8]. These techniques produce results with at least 100 times smaller uncertainty than traditional spectroscopy involving wavelength measurement. The lower uncertainty has had impact in areas, such as radio astronomy and investigations of the upper atmosphere, where better determinations of spectral lines have facilitated studies of important molecules in space and in the stratosphere. Another notable result was the use of the methods to generate extensive tables of accurately measured spectral lines across the infrared spectrum [9]. These tables have contributed significantly to the reliability of laboratory spectroscopic measurements throughout this spectral region.

It is worth noting that management terminated the NBS work on frequency-synthesis chains shortly after

completion of the work that led to the meter redefinition. Staff involved in this effort then redirected their efforts toward other programs. Ken Evenson, Russ Petersen, and Joe Wells initiated new work on high-resolution frequency-based spectroscopy using the mixing methods developed for the frequency-synthesis chain, while Bruce Danielson and Gordon Day eventually became involved in optical-fiber metrology and in other optical communication measurements. John Hall went on to develop high-performance laser systems within the Quantum Physics Division, a joint NIST-JILA enterprise, and Dick Barger left NBS to work at the University of Colorado. Russ Petersen died suddenly in 1983, just two months after the redefinition of the meter was made official, and Dick Barger died in 1998. Ken Evenson, Bruce Danielson, and Joe Wells have since retired from NIST.

Prepared by Donald B. Sullivan.

Bibliography

- [1] K. M. Evenson, J. S. Wells, F. R. Petersen, B. L. Danielson, G. W. Day, R. L. Barger, and J. L. Hall, Speed of Light from Direct Frequency and Wavelength Measurements of the Methane-Stabilized Laser, *Phys. Rev. Lett.* **29**, 1346-1349 (1972).
- [2] E. B. Rosa and N. E. Dorsey, A new determination of the ratio of the electromagnetic to the electrostatic unit of electricity, *Bull. Bur. Stand.* **3**, 433-604 (1907); A comparison of the various methods of determining the ratio of the electromagnetic to the electrostatic unit of electricity, *Bull. Bur. Stand.* **3**, 605-622 (1907).
- [3] K. D. Froome, A new determination of the free-space velocity of electromagnetic waves, *Proc. R. Soc. London, Ser. A* **247**, 109-122 (1958).
- [4] D. A. Jennings, C. R. Pollock, F. R. Petersen, R. E. Drullinger, K. M. Evenson, and J. S. Wells, Direct frequency measurement of the I₂-stabilized He-Ne 473-THz (633-nm) laser, *Opt. Lett.* **8**, 136-138 (1983).
- [5] C. R. Pollock, D. A. Jennings, F. R. Petersen, J. S. Wells, R. E. Drullinger, E. C. Beaty, and K. M. Evenson, Direct frequency measurements of transitions at 520 THz (576 nm) in iodine and 260 THz (1.15 μm) in neon, *Opt. Lett.* **8**, 133-135 (1983).
- [6] Documents concerning the new definition of the metre, *Metrologia* **19**, 163-178 (1984).
- [7] K. M. Evenson, D. A. Jennings, and F. R. Petersen, Tunable far-infrared spectroscopy, *Appl. Phys. Lett.* **44**, 576-578 (1984).
- [8] M. Inguscio, L. R. Zink, K. M. Evenson, and D. A. Jennings, Sub-Doppler tunable far-infrared spectroscopy, *Opt. Lett.* **12**, 867-869 (1987).
- [9] Arthur G. Maki and Joseph S. Wells, *Wavenumber Calibration Tables From Heterodyne Frequency Measurements*, NIST Special Publication 821, National Institute of Standards and Technology, Gaithersburg, MD (1991).

Connecting Visible Wavelength Standards With X Rays and γ Rays

The 1996 centenary of W. K. Röntgen's discovery of x rays celebrated the penetrating visions offered by these "strange rays." Aside from their ubiquitous application to imaging the interior structure of visually opaque systems, x rays continue to have important applications in elucidating the geometrical and electronic structure of matter. In addition to the synchrotron radiation facilities, conventional x-ray sources available in modest laboratory environments have wavelengths well suited to reveal the arrangements of atoms in crystalline solids and biological molecules. In addition, spectroscopy of absorbed and emitted x rays reveals the electronic structure of atoms, molecules and materials. In a similar way, nuclear γ -rays reflect the energy level structure of nuclei in a wavelength range that extends as far beneath the scale of x-ray wavelengths as x-ray wavelengths lie below visible wavelengths.

X-ray diffraction, first reported in 1912, connects x-ray wavelengths with the dimensions of crystal lattices, but fails to connect either of these scales with the dimensions of macroscopic objects. From the early 1930's to the early 1970s, x-ray spectroscopy was an important contributor to the determination of fundamental constants such as N_A , h/e , and hc/e . These measurements were, however, limited by uncertainty in the connection between the x-ray scale and visible reference wavelengths. Up to the mid-seventies, the only well established direct connection was by means of ruled grating diffraction of long wavelength x-ray lines, a procedure that even in its late development was not sufficiently accurate. The paper *X-ray to Visible Wavelength Ratios* [1] represents the first results of a more direct and robust connection between these disparate spectral domains.

Because relative measurements of x-ray wavelengths were more accurate than those linking x-ray wavelengths to macroscopic standards, early workers in the x-ray region introduced local reference standards that approximated sub-multiples of optical units, but were more sharply defined. The local unit in the x-ray region was called the xu, a unit that was intended to approximate 0.001 Å (0.1 pm). Although originally defined by assigning a conventional value to the lattice spacing of rock salt, and later that of calcite, the x-unit was more often specified by assigning particular values (in xu) to the wavelength of one of the widely used reference lines in the x-ray region.

It was not until around 1930 that the 1926 demonstration of x-ray diffraction by a ruled optical grating achieved a refinement capable of providing a useful conversion factor between x-ray and optical units. Results from this work were at variance with the local x-ray unit calculated by making use of the electron's charge determined by Millikan's oil drop experiment. The disagreement ($>0.2\%$) remained controversial for over a decade. In the end, it was shown that the oil drop measurement of e contained an error arising from the viscosity of air.

Realization of the first x-ray interferometer by Bonse and Hart in 1965[2] opened another route to x-ray wavelengths, and subsequently to the γ -ray region. The path to a significant measurement began with Hart's "Ångström ruler" [3], an articulated silicon monolith able to scan over an extended, though limited, range. Subsequently, Bonse and TeKaas demonstrated the quasi-static re-assembly of separated components while retaining favorable intensity contrast [4]. The first combined x-ray and optical interferometer was realized at the NBS [5].

The subject paper [1] reported combined X-Ray and Optical Interferometry (XROI) of the lattice period of a silicon crystal, followed by accurate spectrometry to determine the two most commonly used x-ray reference wavelengths, Cu $K\alpha_1$ and Mo $K\alpha_1$. This measurement plan connected manifestly invariant quantities. The crystal spacing was determined with respect to the optical reference in the XROI measurement and then used, through absolute angle measurement, to link the optical "standard" to x-ray transition wavelengths. Although it has been proposed that the lattice period of silicon (at specific temperature, pressure and purity) should be treated as a "constant of nature" [6], we restrict such usage to transitions between atomic energy levels (x rays), or between nuclear energy levels (γ rays).

The subject paper describes both parts of the measurement (for x rays) with an emphasis on the XROI component owing to its perceived difficulty and novelty. The original cartoon illustration shown in Fig. 1 has been widely reproduced in textbooks and elsewhere, possibly on account of its deceptive simplicity. The stationary and moving platforms were supported by a flexure stage. In actual data taking, the mechanical stage was "locked" to an optical interference maximum by means of a piezoelectric actuator situated in the drive.

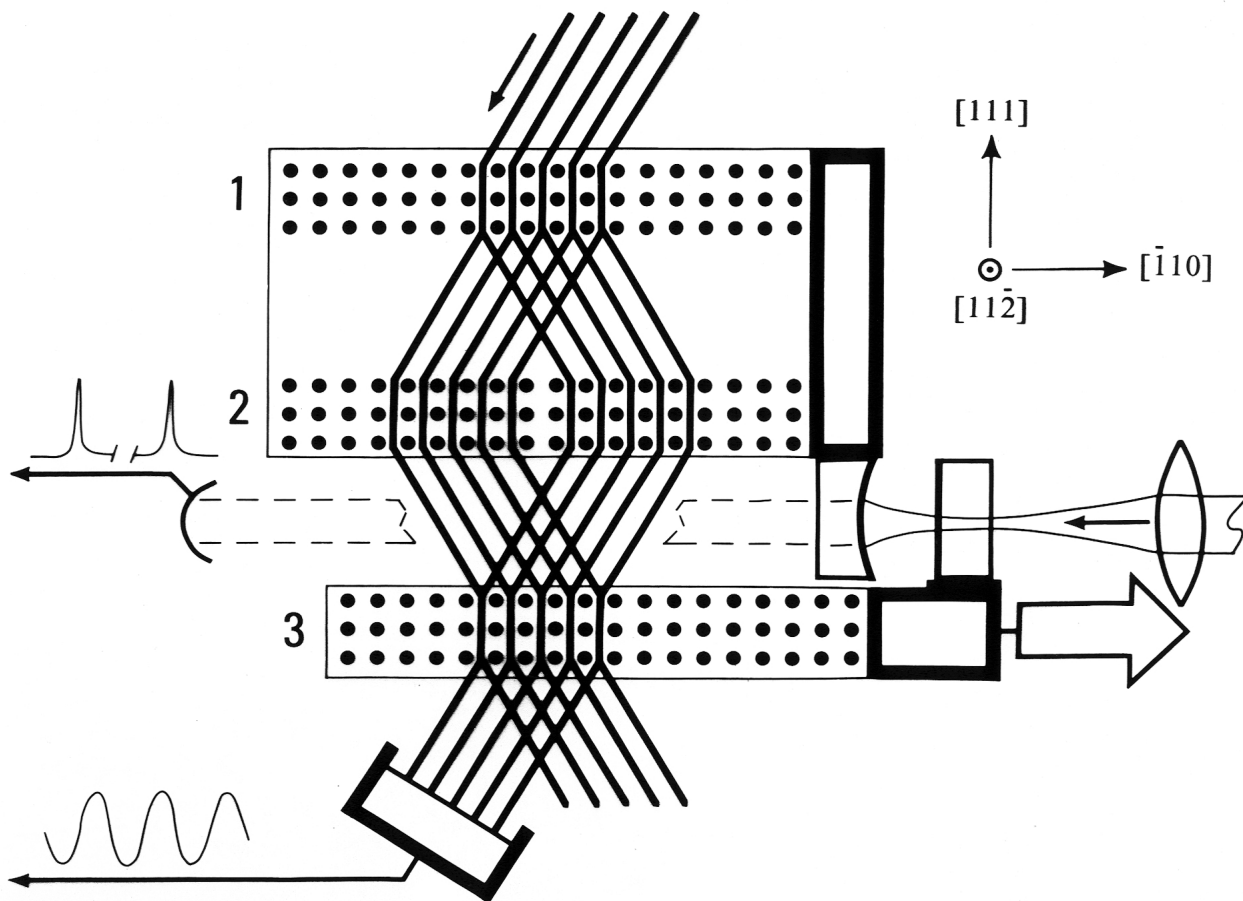

Fig. 1. Schematic of early x-ray and optical interferometry apparatus.

The possibility of a significant (1.8×10^{-6}) problem in this early measurement was suggested by a series of excellent measurements carried out at the Physikalisch-Technische Bundesanstalt (PTB) under the guidance of the late Peter Seyfried [7]. The discrepancy remained a puzzle until the NBS apparatus was retrofitted with additional interferometers designed to track the “pitch” and “yaw” errors. It became clear that the constancy in x-ray interference contrast over scans of hundreds of optical periods, from which rectilinear motion had been inferred, arose instead from mechanical noise that limited the maximum interference contrast [8].

The principal short term impact of this paper was its provision of enabling technology for three other efforts. The most familiar of these is the first “modern” determination of the Avogadro constant, N_A , connecting the ^{12}C -based scale of atomic masses with the artifact-based scale for macroscopic mass [9, 10]. This was followed by the first applications of the same measurement paradigm to the determination of the energy scale for

nuclear γ -rays [11], and extension of the methods of the initial paper to the principal K-series x-ray lines of tungsten [12], several rare earth elements, plus thorium and uranium [13]. These short-term efforts led to a longer term multinational effort addressing the Avogadro constant, and a joint program of NBS/NIST and Institut Laue-Langevin that has extended optically based wavelength measurement in the γ -ray region up to 7 MeV.

NBS work on the Avogadro constant *via* the X-Ray Crystal Density (XRCD) approach began around 1970. The basic idea dates from 1913-14 when W. H. Bragg and W. L. Bragg used the inverse of N_A to infer the lattice constant of rock salt (NaCl). Subsequently, the XRCD procedure has appeared in several forms, not only addressing the problem of N_A determination, but also establishing the most modern (and likely the last) local wavelength unit for x rays, the A^* unit [14]. All work in this area, prior to that at NBS in the early 70s, had two principal limitations.

The first limitation was use of liquid water as a density standard. Although much effort had gone into establishing the density of Standard Mean Ocean Water (SMOW), application of this value to a particular local water sample is problematical. In addition, water in its fully cleaned and degassed form is unstable with respect to re-dissolution of atmospheric gases, and it is relatively corrosive. To get around this problem, the NBS Mass Group introduced a density scale based on solid objects and used a fluorocarbon immersion fluid that was non-corrosive and had a significant capacity to dissolve gases [15]. Solid objects used in this initial work were readily available highly regular steel spheres.

A second limitation arose from the use of "tabulated" atomic weights. Such tabulated values approximate the world average of the geochemically variable isotopic abundances. Such variability in the case of silicon is

large enough to prevent a significant determination of N_A . The NBS work was the first to employ the (now standard) practice of direct isotopic abundance measurement of the actual material used in the density measurement [16]. The importance of this is illustrated in Fig. 2 where we have shown a plot of crystal density as a function of the mean molar mass (atomic weight). Lattice changes over the normal range of abundance variability are small enough that the ratio of mean molar mass to density should be constant, determined by the slope of the line shown in Fig. 2.

Just as the x-ray region had a local unit, so too did the γ -ray domain. In this case, the *de facto* standard was based on a rather complex determination of the transition energy of the ^{198}Hg daughter of $^{198}\text{Au}^*$. The numerical value for this approximately 411 keV transition was used as a reference value for most other γ -ray transitions. In this role, it was (properly) used without

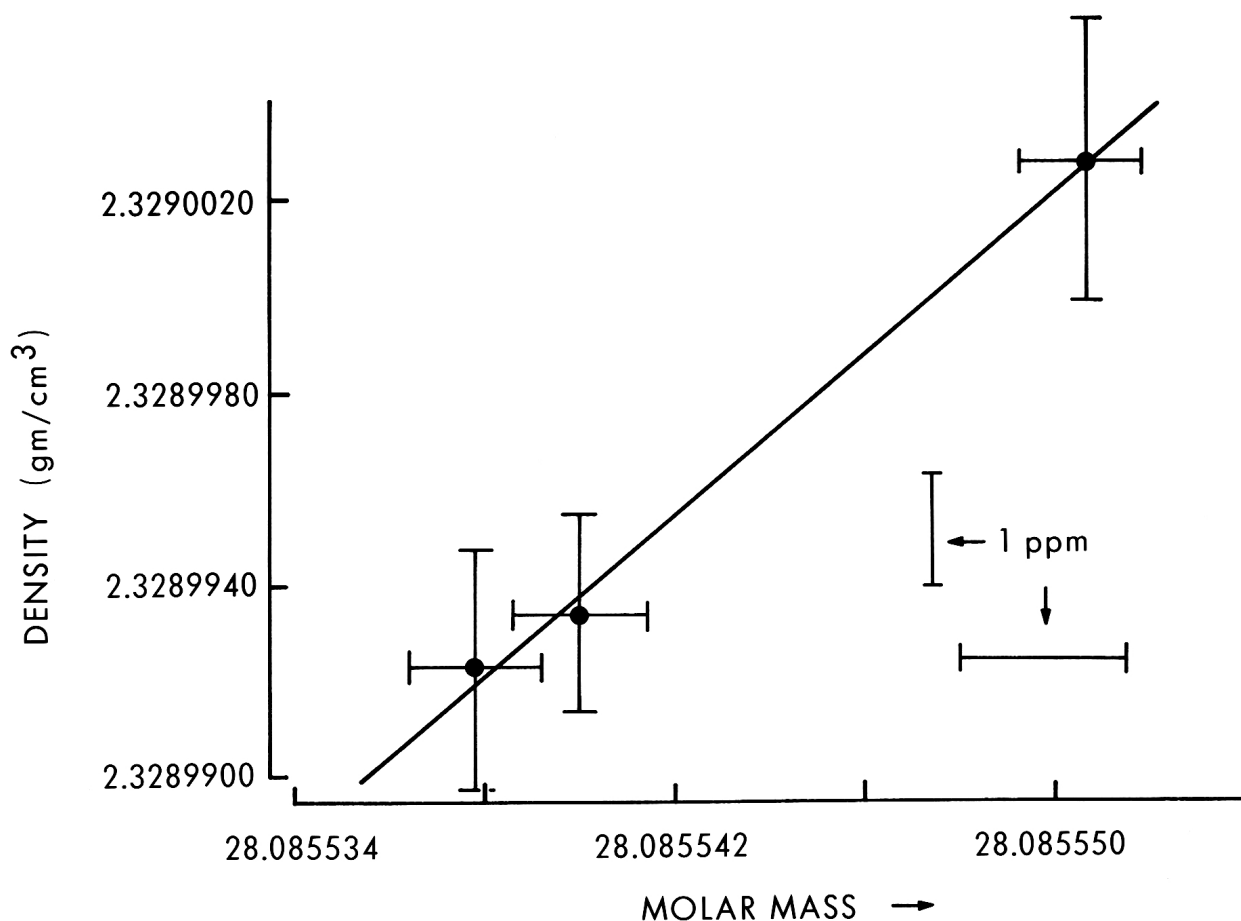

Fig. 2. Density response of silicon to molar mass changes.

uncertainty. However, in the case of fundamental constants or tests of physical theory, the uncertainty naturally entered directly.

Responding to a generally accepted need to improve this reference transition, NBS mounted an effort to extend the optically based measurement chain into the γ -ray region. Results for both the 411 keV and the 675 keV transitions in a strong ^{198}Au source activated in the NBS reactor were reported in 1978 along with new measurements of nine transitions in ^{192}Ir covering the range from 205 keV to 612 keV. In the case of the 411 keV line from ^{198}Au the result was 25×10^{-6} higher than the previous value and claimed a forty-fold improvement in accuracy [11].

The combined effects of this initial work and subsequent efforts toward improved linkages among the several wavelength regions have effectively unified the entire electromagnetic scale. The efforts arising from the subject paper may be thought of as beginning the process of extending the reach of frequency synthesis from the visible wavelength region into the domain of x rays and γ rays. The improved visible-to-x-ray and visible-to- γ -ray connections yielded new values for certain elementary particle masses, more critical tests of quantum electrodynamics (QED) (in the spectroscopy of one-electron heavy ions), a new, SI-based, all-Z tabulation of x-ray transitions, and improved estimates of nuclear binding energies with sufficient accuracy to impact nuclear mass values. Aside from these developments, which were anticipated, the NIST γ -ray instrumentation has had significant unanticipated usefulness in the determination of lifetimes of nuclear excited states in the sub-picosecond range and determination of interatomic potentials in the 10 eV to 100 eV range.

Several of the national metrology institutes (NMIs) have formed an international Avogadro group focusing on a possible atomic replacement for the artifact kilogram. Major programs are currently underway in Germany, Japan, Italy, and Australia. The needed isotopic abundance ratios are being determined at the Institute for Reference Materials and Measurements (IRMM) in Belgium, sponsored by the European Union. Most of the procedures in this worldwide effort are direct descendants of the initial NBS effort of the 1970's. NIST no longer has significant activity in this area with the exception of relative lattice parameter measurements and ad hoc contributions to the understanding of the troublesome molar volume anomaly in the period from 1994 to 2000. Overall, the initial Avogadro work at NBS led to improved methods of measurement in the areas of density, displacement, and molar mass as well as to the viable possibility of an atomically based replacement for the artifact kilogram.

The first generation of γ -ray measurements at NBS used radioactive sources activated in the NBS reactor. Extension of this work to higher energies required access to short-lived excited nuclei only accessible through targets internal to a high flux reactor. Only the research reactor at the Institut Laue-Langevin (ILL) in Grenoble is configured to allow access to such sources. A new γ -ray instrument specifically matched to this application was installed at the ILL in the mid-eighties and is now included in the ILL facilities inventory as GAMS4.

GAMS4 extends the optically based γ -ray wavelength scale to energies far higher than were accessible with activated sources from the NBS reactor. It has allowed determination of specific γ -ray transition energies leading to new values for the neutron mass [17] and to the possibility of a γ -ray/atomic mass determination of the molar Planck constant [18]. The neutron mass was addressed at an early stage and recently revisited with further improved results [19]. Because of the evolution in other parts of the fundamental physical constants, the molar Planck constant is now accurately established indirectly. The associated γ -ray measurements now are verifiers of high accuracy trap-based mass spectrometry results.

In addition to its use in high accuracy measurements, GAMS4 delivers higher spectroscopic resolving power than had been available previously. This exceptional resolution revealed (initially unexpected) broadening and fine-scale structural detail within individual γ -ray profiles. The basic understanding of these line shapes as recoil-induced Doppler profiles, modulated by collisional deceleration, emerged from a brief but very fruitful period in 1987 [20]. Our principal ILL collaborators, Hans Börner and his associates, have further developed the understanding of this complex process [21]. GAMS4 is now seen as an effective means for determination of nuclear excited state lifetimes in the sub-picosecond domain [22] and a fertile test bed for models of interatomic potentials in the 10 eV to 100 eV range [23]. This work has been widely recognized in Europe. It was identified as one of the two most significant nuclear physics results for 1992 [24]. Börner received the 1990 Roentgen prize of the German Physical Society, and a student who used GAMS4 for his thesis research received the F. Schlaflli Prize of the Swiss Academy of Natural Sciences [25].

Two international workshops on applications of high precision γ -ray spectroscopy have now taken place. The first was in Grenoble in 1992, and the second, in South Bend, Indiana, in 1998, is summarized in a special issue of the *NIST Journal of Research*, January-February 2000. Most contributions to these meetings were based

on experimental work carried out using GAMS4 or on theoretical developments in molecular dynamic simulations attuned to past or future experimental results from GAMS4. As an ILL user facility, GAMS4 applications are part of the normal proposal stream. Up to 2000, when this commentary is being prepared, requests for access to GAMS4 have exceeded available time by a factor of two. In response to this proposal pressure, and to increase the very low efficiency of GAMS4, the ILL has undertaken new instrument development. This new facility, GAMS5, is operational but still under development.

Publication of the first comprehensive (all-Z) theoretical study of x-ray transition energies [26] came just after the first few of the new NBS experimental measurements. The extraordinary clarity of the initial comparisons and the unexpected linear Z-dependence of the discrepancy invited extension and refinement on the part of both theory and experiment. This first comprehensive calculation was in the Dirac-Hartree-Slater framework, and the puzzling Z-dependence shown in Fig. 3 was found to be due to use of incorrect values for nuclear radii. Subsequent refinements included some relativistic corrections and inclusion of a properly diffuse nuclear boundary [27].

Following this early period, a collaboration with Paul Indelicato (Paris) was initiated, aimed at progressively more refined, more rigorous and more detailed calculations. These initial efforts involved theoretical work at the level of multi-configuration Dirac-Fock with approximate allowance for QED effects. As this work progressed through stages of increasing refinement and understanding, it became clear that hole-state dynamics would have to be considered. NIST was fortunate in this respect to engage the collaboration of Eva Lindroth, who brought the techniques of many-body perturbation theory to bear on estimation of level shifts due to coupling of inner vacancy states to their associated decay continua [28].

All of these theoretical developments have now been linked with an expanded and improved experimental framework to produce a new and unprecedented view of principal x-ray transitions for all elements from neon to fermium. Previous attempts at such a synoptic overview have been for the most part entirely empirical, while there have been a few attempts to produce a comprehensive theoretical database. The NIST effort has combined these two approaches with certain important changes. First, the experimental database is skeletal rather than comprehensive. Items included in the experimental

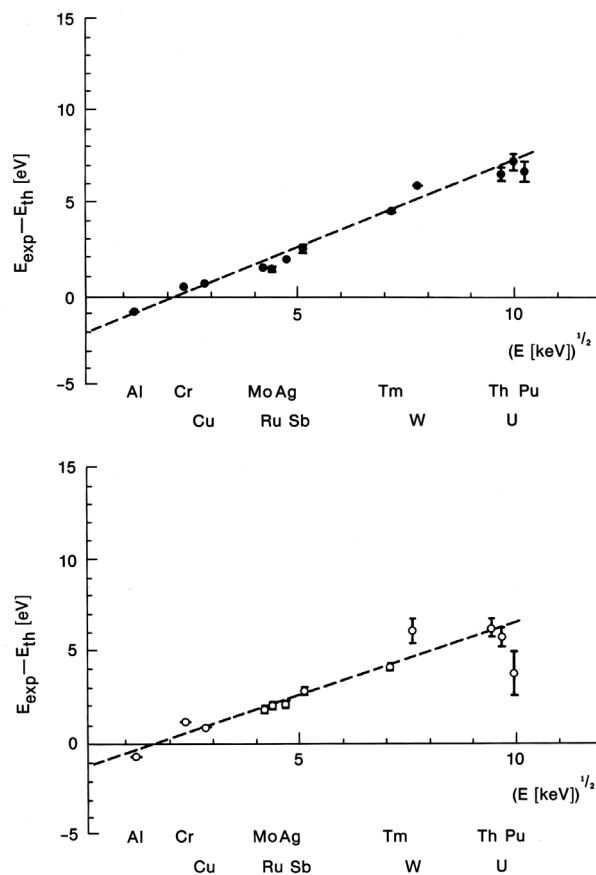

Fig. 3. Atomic transition response to errors in nuclear radii.

database were either measured directly in accordance with the best of modern practice, or were referenced to other transitions that had been directly measured according to best practice. Second, the theoretical component was constructed with a high level of rigor that included not only a multi-configuration basis set with relativistic and QED corrections, but also the modification of these levels due to their coupling to associated decay continua.

Richard Deslattes began work in the Crystal Chemistry Section of the Analytical Chemistry Division in 1962. He subsequently headed a newly named Quantum Metrology Section in the Physics Division of the Center for Absolute Physical Quantities. This Section became for a brief time the Quantum Metrology Division in the Physics Laboratory. Its remnants remain as the Quantum Metrology Group of the Atomic Physics Division of the NIST Physics Laboratory. In 1981-2 he served as Director of the Physics Division of the

National Science Foundation. In 1983 he was designated as a Senior NBS Fellow. In 1984-5 he was a U.S. Senior Awardee of the Alexander von Humboldt Stiftung, visiting the University of Heidelberg and working at the Max Planck Institute for Nuclear Physics, the Gesellschaft für Schwerionenforschung and the Institut Laue-Langevin. His awards include the Gold and Silver Medals of the Commerce Department.

Albert Henins came to NBS in 1970 as a Physicist. He continued to serve in that capacity until his retirement in 1998.

Prepared by Richard D. Deslattes.

Bibliography

- [1] Richard D. Deslattes and A. Henins, X-Ray to Visible Wavelength Ratios, *Phys. Rev. Lett.* **31**, 972-975 (1973).
- [2] U. Bonse and M. Hart, An X-ray interferometer, *Appl. Phys. Lett.* **6**, 155-156 (1965).
- [3] M. Hart, An Ångström Ruler, *Br. J. Appl. Phys., Ser. 2* **1**, 1405-1408 (1968).
- [4] U. Bonse and E. te Kaat, A Two-Crystal X-Ray Interferometer, *Z. Phys.* **214**, 16-21 (1968).
- [5] Richard D. Deslattes, Optical and X-Ray Interferometry of a Silicon Lattice Spacing, *Appl. Phys. Lett.* **15**, 386-388 (1969).
- [6] J. Martin, U. Kuetgens, J. Stümpel, and P. Becker, The silicon lattice parameter—an invariant quantity of nature?, *Metrologia* **35**, 811-817 (1998).
- [7] Peter Becker, Klaus Dorenwendt, Gerhard Ebeling, Rolf Lauer, Wolfgang Lucas, Reinhard Probst, Hans-Joachim Rademacher, Gerhard Reim, Peter Seyfried, and Helmut Siegert, Absolute Measurement of the (220) Lattice Plane Spacing in a Silicon Crystal, *Phys. Rev. Lett.* **46**, 1540-1543 (1981).
- [8] Richard D. Deslattes, Mitsuru Tanaka, Geoffrey L. Greene, Albert Henins, and Ernest G. Kessler, Jr., Remeasurement of a Silicon Lattice Period, *IEEE Trans. Instrum. Meas.* **IM-36**, 166-169 (1987).
- [9] R. D. Deslattes, A. Henins, H. A. Bowman, R. M. Schoonover, C. L. Carroll, I. L. Barnes, L. A. Machlan, L. J. Moore, and W. R. Shields, Determination of the Avogadro Constant, *Phys. Rev. Lett.* **33**, 463-466 (1974).
- [10] R. D. Deslattes, A. Henins, R. M. Schoonover, C. L. Carroll, and H. A. Bowman, Avogadro Constant-Corrections to an Earlier Report, *Phys. Rev. Lett.* **36**, 898-900 (1976).
- [11] E. G. Kessler, Jr., R. D. Deslattes, A. Henins, and W. C. Sauder, Redetermination of ^{198}Au and ^{192}Ir γ -Ray Standards between 0.1 and 1.0 MeV, *Phys. Rev. Lett.* **40**, 171-174 (1978).
- [12] E. G. Kessler, Jr., R. D. Deslattes, and A. Henins, Wavelength of the $W K\alpha_1$ x-ray line, *Phys. Rev. A* **19**, 215-218 (1979).
- [13] E. G. Kessler, Jr., R. D. Deslattes, D. Girard, W. Schwitz, L. Jacobs, and O. Renner, Mid-to-high-Z precision x-ray measurements, *Phys. Rev. A* **26**, 2696-2706 (1982).
- [14] Ivars Henins and J. A. Bearden, Silicon-Crystal Determination of the Absolute Scale of X-Ray Wavelengths, *Phys. Rev.* **135A**, A890-A898 (1964).
- [15] H. A. Bowman, R. M. Schoonover, and C. L. Carroll, The Utilization of Solid Objects as Reference Standards in Density Measurements, *Metrologia* **10**, 117-121 (1974).
- [16] I. L. Barnes, L. J. Moore, L. A. Machlan, T. J. Murphy, and W. R. Shields, Absolute Isotopic Abundance Ratios and the Atomic Weight of a Reference Sample of Silicon, *J. Res. Natl. Bur. Stand.* **79A**, 727-735 (1975).
- [17] G. L. Greene, E. G. Kessler, Jr., R. D. Deslattes, and H. Börner, New Determination of the Deuteron Binding Energy and the Neutron Mass, *Phys. Rev. Lett.* **56**, 819-822 (1986).
- [18] E. G. Kessler, G. L. Greene, M. S. Dewey, R. D. Deslattes, H. Börner, and F. Hoyler, High accuracy, absolute wavelength determination of capture gamma-ray energies for $E \leq 5$ MeV and the direct determination of binding energies in light nuclei, *J. Phys. G: Nucl. Phys.* **14** Suppl., S167-S174 (1988).
- [19] E. G. Kessler, Jr., M. S. Dewey, R. D. Deslattes, A. Henins, H. G. Börner, M. Jentschel, C. Doll, and H. Lehmann, The deuteron binding energy and the neutron mass, *Phys. Lett. A* **255**, 221-229 (1999).
- [20] H. G. Börner, J. Jolie, F. Hoyler, S. Robinson, M. S. Dewey, G. Greene, E. Kessler, and R. D. Deslattes, Determination of Short Lifetimes with Ultra High Resolution (n, γ) Spectroscopy, *Phys. Lett. B* **215**, 45-49 (1988).
- [21] H. G. Börner, J. Jolie, S. J. Robinson, R. L. Gill, and R. F. Casten, New Reactor Based Methods to Measure Short Lifetimes of Nuclear Excited States, *Neutron News* **2** (4), 20-24 (1991).
- [22] H. G. Börner and J. Jolie, Sub-picosecond Lifetime Measurements by Gamma Ray Induced Doppler Broadening, *J. Phys. G: Nucl. Phys.* **19**, 217-248 (1993).
- [23] M. Jentschel, K. H. Heinig, H. G. Börner, J. Jolie, and E. G. Kessler, Atomic collision cascades studied with the Crystal-GRID method, *Nucl. Instrum. Methods Phys. Res., Sect. B* **115**, 446-451 (1996).
- [24] *Encyclopedia Britannica*, in Yearbook of Science and the Future (1992) pp. 395-396.
- [25] N. Stritt, J. Jolie, M. Jentschel, H. G. Börner, and C. Doll, Investigation of the interatomic potential using the crystal gamma-ray-induced Doppler-broadening method on oriented Ni single crystals, *Phys. Rev. B: Condens. Matter* **59**, 6762-6773 (1999).
- [26] Keh-Ning Huang, Michio Aoyagi, Mau Hsiung Chen, Bernd Crasemann, and Hans Mark, Neutral-atom electron binding energies from relaxed-orbital relativistic Hartree-Fock-Slater calculations, $2 \leq Z \leq 106$, *At. Data Nucl. Data Tables* **18**, 243-291 (1976).
- [27] Mau Hsiung Chen, Bernd Crasemann, Michio Aoyagi, Keh-Ning Huang, and Hans Mark, Theoretical Atomic Inner-Shell Energy Levels, $70 \leq Z \leq 106$, *At. Data Nucl. Data Tables* **26**, 561-574 (1981).
- [28] P. Indelicato and E. Lindroth, Current status of the relativistic theory of inner hole states in heavy atoms, *Comments At. Mol. Phys.* **32**, 197-208 (1996).

Laser Cooling of Atoms

The concept of radiation-pressure cooling of atoms was independently suggested in 1975 for the case of a gas of neutral atoms by Hänsch and Schawlow, and for atomic ions bound in an electromagnetic trap by Wineland and Dehmelt. While the notion that momentum exchange from a photon moving in the opposite direction could slow an individual atom was well understood, until this time no one had come up with a means for producing an aggregate cooling of a larger ensemble of atoms (a gas). If all atoms in a hot gas absorb photons, then some will be heated and some cooled, and the ensuing equilibrium temperature is not lowered. The general feature of the cooling concepts is that a gas of atoms or ions can be cooled by ensuring that photon absorption takes place preferentially when the atoms or ions are moving against the flow of photons from a laser.

In 1978, following these ideas, Wineland, Drullinger, and Walls performed their seminal experiment [1] in which they demonstrated the very first radiation-pressure cooling below ambient temperature of any atomic species. The key to the experiment was the variation in photon absorption associated with the Doppler frequency shift. They used a collection of positive magnesium ions contained in an electromagnetic trap subjected to laser radiation near the ~ 280 nm resonance of the magnesium ion. When this laser radiation was tuned slightly below resonance, cooling to below 40 K was observed. For this particular tuning, those ions with motions opposing the laser radiation are Doppler shifted toward resonance and are more likely to absorb photons, thus slowing their motions. Ions moving away from the source are Doppler shifted further from resonance and are thus less likely to absorb photons. Since the re-radiation from this excited state is symmetric, the net effect averaged over the ensemble of atoms is a cooling of the gas of ions. The very next year, Wineland and Itano [2] published a paper providing the first detailed theoretical analysis of laser cooling, which served as the foundation for the rapid development of this field. In ensuing years, they improved their methods and soon cooled ions to millikelvin temperatures.

This experimental demonstration stimulated the development of a large number of ion-cooling groups around the world and encouraged others to attempt to

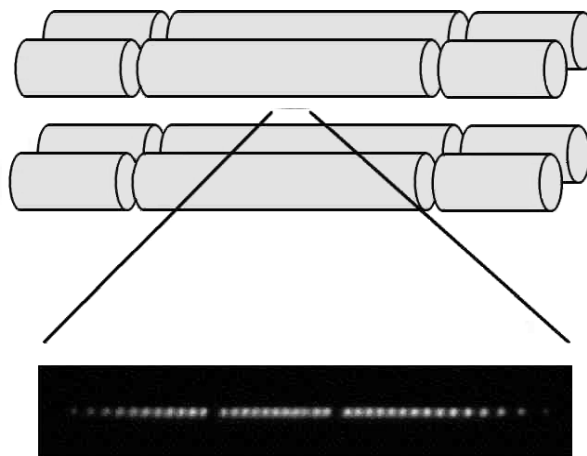

Fig. 1. A schematic diagram of a linear ion trap using alternating and static electric fields to confine linear arrays or “strings” of ions. The expanded ultraviolet image at the bottom shows the fluorescence image of an array of positive mercury ions.

cool neutral atoms. In fact, it was only a few years later (in 1982) that a beam of neutral atoms was cooled by Bill Phillips and his collaborators at NIST (as described elsewhere in this volume). These ideas have contributed significantly to atomic-clock technology. Clocks using both trapped ions [3] and cooled neutral atoms [4] have now demonstrated frequency uncertainties of a few parts in 10^{15} , an improvement of an order of magnitude over conventional atomic-clock technology. Further improvements will certainly be demonstrated over the next few years. The potential of the cooled-ion standards can be appreciated by recognizing that, for a small group of ions, the systematic frequency shifts are now understood at an uncertainty level of 1 part in 10^{18} .

Based on this early work, NBS established an Ion Storage Group in Boulder; the Group now includes five full-time staff members and a number of postdoctoral associates, guests, and students. After the initial cooling experiments, the methods were improved, but particularly striking results were obtained by cooling at the sideband frequency created by the periodic motion of the trapped ions. Using this method, the Group achieved, for the first time, cooling to the zero-point energy of motion [5,6], the fundamental limit for any cooling technique.

A unique aspect of the ion-cooling work has been the ability to do experiments with individual atoms. The NBS Group developed remarkable techniques that allowed them to observe and control both the motional and internal quantum states of individual ions, and thereby to confirm experimentally some of the fundamental concepts upon which quantum mechanics is based. For example, they observed individual quantum transitions of a single ion with 100 % probability [7], performed Young's classical light interference experiment with radiation scattered by two ions [8], performed absorption spectroscopy on a single ion [9], observed fundamental quantum-projection noise [10], and demonstrated a "Schrödinger-cat" entangled superposition state of an atom [11]. The ability to control completely the states of ions has led them to show that properly coupled ions can perform simple quantum-

logic operations [12]. While the realization of a useful quantum computer faces severe obstacles, the projected performance of such a computer is so great that many groups worldwide have now begun to pursue this objective. The NIST Ion-Storage Group continues to work at the forefront of this field.

Another important line of work that grew out of this program has been the study of the behavior of larger groups of ions that form what are called nonneutral plasmas [13]. The NIST Group has cooled these plasmas to the point where they exhibit liquid and even crystalline behavior [14]. The surprising thing is that these cooled plasmas exhibit behavior analogous to that of very dense, hot neutron stars. In addition, they can be controlled well enough to allow precision studies of fundamental equilibria and dynamical behavior.



Fig. 2. The three physicists involved in this first laser-cooling experiment. Pictured from left to right are Dave Wineland, Bob Drullinger, and Fred Walls.

The three NIST-Boulder authors of this seminal paper continue to work in the Time and Frequency Division in Boulder, and each has become a world leader in a key program within the Division. Dave Wineland heads the Ion Storage Group, which continues to open up new areas of research based on trapped, laser-cooled ions. Of most recent note is his world leadership in the area of quantum logic and entangled quantum states. In recognition of his many accomplishments, Wineland has been elected a Member of the National Academy of Sciences, a Fellow of the American Physical Society and a Fellow of the Optical Society of America. He has been awarded a long list of honors, including the Davisson-Germer Prize of the American Physical Society, the William F. Meggars Award of the Optical Society of America, the I. I. Rabi Award of the IEEE, the Einstein Medal for Laser Science of the Society of Optical and Quantum Electronics, the DOC Gold and Silver Medals, NIST's Samuel Wesley Stratton Award and NIST's Edward Uhler Condon Award. Following the ion-cooling experiment, Bob Drullinger contributed to the optical frequency measurements that led to the redefinition of the meter, then went on to lead the development of NIST-7, an optically pumped cesium-beam frequency standard that became NIST's primary frequency standard in 1993. This is clearly the most accurate atomic-beam standard ever built. For this work he was awarded the DOC Gold Medal and the I. I. Rabi Award of the IEEE. Fred Walls went on to lead the development of a passive hydrogen maser of exceptional merit. He then shifted to the development of low phase-noise and amplitude-noise electronics of importance to time-and-frequency metrology and to the accurate measurement of spectral purity. He has become the world leader in this field, and in recognition of this leadership was elected a Fellow of the American Physical Society. He has also been recognized with the very first Time and Frequency Award given by the European Frequency and Time Forum, the I. I. Rabi Award of the IEEE, three DOC Silver Medals, IEEE's Millennium Medal, and NIST's Edward Bennett Rosa Award.

Prepared by D. B. Sullivan.

Bibliography

- [1] D. J. Wineland, R. E. Drullinger, and F. L. Walls, Radiation-pressure cooling of bound resonant absorbers, *Phys. Rev. Lett.* **40**, 1639-1642 (1978).
- [2] D. J. Wineland and W. M. Itano, Laser cooling of atoms, *Phys. Rev. A* **20**, 1521-1540 (1979).
- [3] D. J. Berkeland, J. D. Miller, J. C. Bergquist, W. M. Itano, and D. J. Wineland, Laser-cooled mercury ion frequency standard, *Phys. Rev. Lett.* **80**, 2089-2092 (1998).
- [4] S. R. Jefferts, D. M. Meekhof, J. Shirley, T. E. Parker, C. Nelson, F. Levi, G. Costanzo, A. DeMarchi, R. Drullinger, L. Hollberg, W. D. Lee and F. L. Walls, The accuracy evaluation of NIST-F1, submitted to *Metrologia*.
- [5] F. Diedrich, J. C. Bergquist, W. M. Itano, and D. J. Wineland, Laser cooling to the zero-point energy of motion, *Phys. Rev. Lett.* **62**, 403-406 (1989).
- [6] C. Monroe, D. M. Meekhof, B. E. King, S. R. Jefferts, W. M. Itano, D. J. Wineland, and P. Gould, Resolved-sideband Raman cooling of a bound atom to the 3D zero-point energy, *Phys. Rev. Lett.* **75**, 4011-4014 (1995).
- [7] J. C. Bergquist, R. G. Hulet, W. M. Itano, and D. J. Wineland, Observation of quantum jumps in a single atom, *Phys. Rev. Lett.* **57**, 1699-1702 (1986).
- [8] U. Eichmann, J. C. Bergquist, J. J. Bollinger, J. M. Gilligan, W. M. Itano, D. J. Wineland, and M. G. Raizen, Young's interference experiment with light scattered from two atoms, *Phys. Rev. Lett.* **70**, 2359-2362 (1993).
- [9] D. J. Wineland and W. M. Itano, Spectroscopy of a single Mg^+ ion, *Phys. Lett.* **82A**, 75-78 (1981).
- [10] W. M. Itano, J. C. Bergquist, J. J. Bollinger, J. M. Gilligan, D. J. Heinzen, F. L. Moore, M. G. Raizen, and D. J. Wineland, Quantum projection noise: Population fluctuations in two-level systems, *Phys. Rev. A* **47**, 3554-3570 (1993).
- [11] C. Monroe, D. M. Meekhof, B. E. King, and D. J. Wineland, A 'Schrödinger Cat' superposition state of an atom, *Science* **272**, 1131-1136 (1996).
- [12] C. Monroe, D. M. Meekhof, B. E. King, W. M. Itano, and D. J. Wineland, Demonstration of a fundamental quantum logic gate, *Phys. Rev. Lett.* **75**, 4714-4717 (1995).
- [13] J. J. Bollinger and D. J. Wineland, Strongly coupled nonneutral ion plasma, *Phys. Rev. Lett.* **53**, 348-351 (1984).
- [14] T. B. Mitchell, J. J. Bollinger, D. H. E. Dubin, X.-P. Huang, W. M. Itano, and R. H. Baughman, Direct observations of structural phase transitions in planar crystallized ion plasmas, *Science* **282**, 1290-1293 (1998).

Spin-Polarized Electrons

In numerous experiments involving electrons, the ability to manipulate the spin of the electron gives unique additional information. For many years, however, such experiments were extraordinarily rare because of the absence of a good source of spin-polarized electrons. Up to the time this paper appeared, sources of spin-polarized electrons produced electron beams of very low intensity or polarization, or both, putting most polarized electron experiments out of reach and making those remaining heroic efforts. When *GaAs Spin-Polarized Electron Source* [1] appeared in print, a large number of proposed measurements were standing by, awaiting an improved source of spin-polarized electrons. The GaAs source proved to be the gateway to many fundamentally new types of experiments in atomic, condensed matter, nuclear, and particle physics.

The principle of the GaAs polarized electron source relies on 1) the photoexcitation of spin-polarized electrons in a solid and 2) their escape into vacuum. The

origin of the spin polarization can be understood by referring to Fig. 1. GaAs is a direct-gap semiconductor with the band gap, E_g , at the center of the Brillouin zone as in the $E(k)$ plot of the energy bands vs. crystal momentum k shown on the left side of Fig. 1. The relative intensities for transitions between m_j sublevels by photoexcitation with circularly polarized σ^+ and σ^- (positive and negative helicity) light are shown on the right side of Fig. 1. The polarization is defined as $P = (N_\uparrow - N_\downarrow)/(N_\uparrow + N_\downarrow)$ where $N_\uparrow(N_\downarrow)$ are the number of electrons with spins parallel (antiparallel) to a quantization direction. Thus, for σ^+ light, quantum mechanical selection rules give the theoretical polarization, $P_{th} = (1-3)/(1+3) = -0.5$ for band gap photoexcitation. An important characteristic of the GaAs source is that the sign of the spin polarization of the excited electrons can be easily changed by reversing the helicity of the incident light without affecting other parameters of the electron beam.

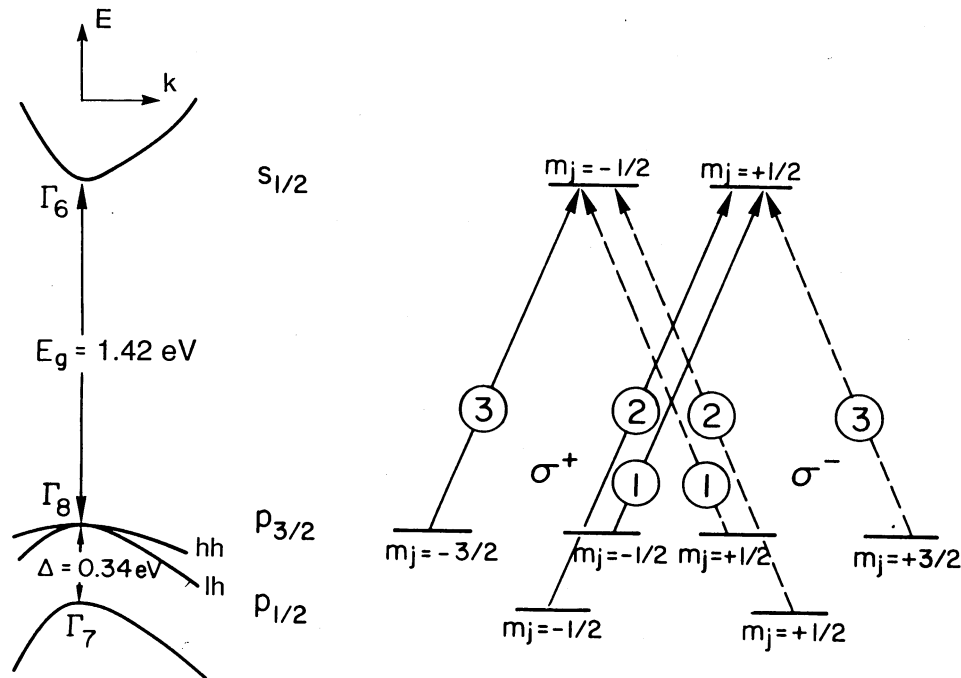

Fig. 1. On the left are depicted the energy bands of GaAs at the center of the Brillouin zone showing the band gap energy E_g and the spin-orbit splitting of the valence band Δ . On the right are shown the allowed transitions between m_j sublevels for circularly polarized light, σ^+ (solid lines) and σ^- (dashed lines), with relative transition probabilities given by the circled numbers.

Ordinarily, electrons excited to the conduction band minimum would be approximately 4 eV below the vacuum level and could not escape from the GaAs. However, by treating the surface of *p*-type GaAs with Cs and O₂ it is possible to lower the vacuum level at the surface below the energy of the conduction band minimum in the bulk to achieve the condition known as negative electron affinity (NEA) shown in Fig 2. NEA GaAs surfaces are extremely efficient photoemitters, which explains their widespread use in photomultiplier tubes, image intensifiers, and night vision devices. It is a lucky happenstance of nature that the world's best photoemitter is also an efficient source of spin-polarized electrons.

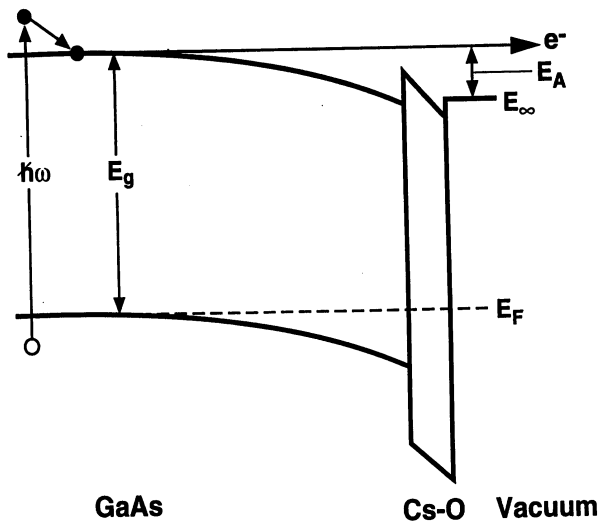

Fig. 2. GaAs surface activated with Cs and O₂ to achieve negative electron affinity E_A (vacuum level E_∞ lower than the conduction-band minimum). Electrons excited across the band gap E_g by photons of energy $\hbar\omega$ thermalize to the conduction-band minimum, diffuse to the surface, and escape into the vacuum.

The purpose of the paper *GaAs Spin-Polarized Electron Source* was to describe how this effect, which had been discovered [2] a few years previously in spin-polarized photoemission experiments by Pierce and coworkers at the ETH-Zurich, could be used to provide a compact spin-polarized electron gun. *GaAs Spin-Polarized Electron Source* gives a comprehensive account not only of the theory of operation of this device, but also of its design, special materials preparation, construction, characterization, and performance. A crucial step is the cleaning of the GaAs photocathode surface, first by a series of chemical processes, and then by heating to just the right temperature in ultrahigh vacuum. The detailed descriptions of this and the sub-

sequent activation of the GaAs photocathode were important to enable others to build their own polarized electron guns. The analysis of the electron optics included the characteristics of the emitted beam, the cathode region, a 90° spherical deflector to change the longitudinal polarization of the emitted electrons to a polarization transverse to the electron momentum, and the transport and focusing system. The modular design provided a 1 keV electron beam suitable for transport through an isolation valve and on to the electron optics of a particular experiment. In this first application, the subsequent electron optics was designed to provide a collimated electron beam with variable energy from a few eV to a few hundred eV, as one would use in a variety of condensed matter physics experiments like spin-polarized low-energy electron diffraction (SPLEED).

The availability of an intense source of electrons with easily modulated degree of spin polarization had immediate impact. The two interactions, the spin-orbit interaction and the exchange interaction, that give rise to spin-dependent electron scattering from surfaces were investigated at NBS and given as examples of applications in the paper *GaAs Spin-Polarized Electron Source*. The spin-orbit interaction is due to the interaction of the spin of the electron with its own orbital angular momentum in scattering from a strong potential and is larger for materials of high atomic number. Large spin-dependent effects were observed in polarized electron scattering from a W(100) surface [3]. The spin dependent scattering asymmetry is readily determined by measuring the ratio of the part of the scattered intensity that varies with the modulation of the incident electron spin polarization to the part that is spin independent. Thus, the spin-dependent information is obtained from simple intensity measurements. The second example was scattering from a single-crystal Ni(110) surface where the spin dependence is due to the exchange interaction [4]. The exchange interaction is a consequence of the Pauli principle requiring the total wave function including spins to be asymmetric with respect to permutation of the particles. These polarized electron scattering measurements from a ferromagnetic surface pioneered a new, sensitive means to measure the degree of surface magnetic order. In another experiment [5] using the GaAs source, spin-polarized electron scattering from a ferromagnetic glass confirmed theoretical predictions that the temperature dependence of the surface magnetization at low temperatures should have the same power law as that of the bulk. However, the discovery of a larger prefactor than predicted led to recognition that the exchange coupling between the surface and the bulk is reduced.

In the 1980s, at NBS and in laboratories around the world, because of spin-polarized electron guns of the type described in *GaAs Spin-Polarized Electron Source*, researchers began making spin-polarized versions of their favorite electron spectroscopies. A case in point is spin-polarized inverse photoelectron spectroscopy (SPIPES). Inverse photoemission (IPES) is complementary to ordinary photoemission spectroscopy (PES). In particular, it permits investigation of unfilled states between the Fermi level and the vacuum level that are inaccessible in ordinary PES. Such states are crucial since it is the *d*-holes in transition-metal ferromagnets that are the “active ingredients” of the magnetism. SPIPES probes the spin-dependent nature of these states, in effect providing a magnetic spectroscopy of electron states. The first SPIPES measurements [6] were made on Ni(110) at NBS in a collaboration with Bell Laboratories colleagues who were involved in some of the first IPES measurements. Other spin polarized spectroscopies using the GaAs source were spin-polarized electron energy loss spectroscopy (SPEELS) [7] and spin-polarized low energy electron microscopy (SPLEEM) [8].

Among the longer term impacts of the paper *GaAs Spin-Polarized Electron Source* and the device described there is the use of such spin-polarized-electron guns in the development of detectors of spin-polarized electrons. In early measurements at NBS, it was found that not only was the scattering of electrons from a magnetic surface spin dependent, but so also was the electron current absorbed in the target [9]. An electron spin analyzer was developed based on this effect [10]. While this spin analyzer turned out to be difficult to use, it was applied in a very important measurement of the spin polarization of the secondary-electron energy distribution generated when an unpolarized electron beam is incident on a ferromagnet [11]. Energy- and spin-resolved measurements carried out at NBS showed that a ferromagnetic metal yields an abundance of highly polarized secondary electrons. This suggested the possibility of achieving high resolution imaging of magnetization of a surface by measuring the polarization of secondary electrons generated in a scanning electron microscope. This technique has come to be known as scanning electron microscopy with polarization analysis or SEMPA. The SEMPA magnetization image is formed by measuring the spin polarization of the secondary electrons as the SEM beam is “rastered” across the sample surface as shown schematically at the top of Fig. 3. The traditional Mott spin-polarization analyzer is large and heavy, in short cumbersome, and not suited for easy attachment to a scanning electron microscope. A new type of spin

analyzer was developed at NBS, using the GaAs spin-polarized-electron gun to survey the phase space of materials, electron energies, and scattering conditions. This new low-energy diffuse-scattering spin analyzer [12] was fist-sized and at least as efficient as its big brother, the high-energy Mott analyzer. SEMPA has since been applied to numerous industrial problems by imaging domains in recording media, recording heads and other magnetic sensors, and magnetic random-access memory elements. The power of seeing the domains in high-resolution SEMPA images has proven very helpful in the development of magnetic random-access memory devices [13].

An especially important application of spin-polarized electrons is illustrated by a SEMPA investigation that took place in the early nineties [14]. At that time, there was a great deal of excitement within the condensed matter physics and magnetism communities as a consequence of a new discovery. A new kind of coupling was found to exist between magnetic layers separated by non-magnetic materials in very thin multilayer structures. The direction and extent of the coupling appeared to depend on the thickness of the non-magnetic layer in a way that did not correspond to any known theory and appeared not to depend strongly on the spacer material. Several innovations made the SEMPA investigation of this magnetic coupling unique. First, an Fe whisker was used as an atomically-perfect substrate. Second, the Cr spacer layer was grown in the shape of a wedge so that the variation of spacer thickness would be continuous as shown at the top of Fig. 3. Third, reflection high energy electron diffraction of the Cr wedge before the top Fe layer was deposited determined the average thickness at each point along the wedge to 0.1 atomic layer. Finally, SEMPA produced a single magnetization image of the top Fe layer, lower part of Fig. 3, where the magnetization changes back and forth from being parallel to the magnetization of the Fe whisker substrate (white regions) to antiparallel (black) as the Cr spacer thickness increases. Two superposed but distinct periods of oscillation of the exchange coupling with Cr thickness were observed. By varying the Cr growth temperature, it was possible to vary the roughness and show that rougher interfaces result from lower temperature growth. For such rough layers, the long-period coupling dominates as illustrated at the bottom right of Fig. 3. This explains why the short-period coupling had not been observed in the less perfect samples previously studied. Clearly, the universal period idea was shown to be invalid. The existence of the second period helped show the relationship of the coupling periodicity to the electronic structure of the spacer-layer material.

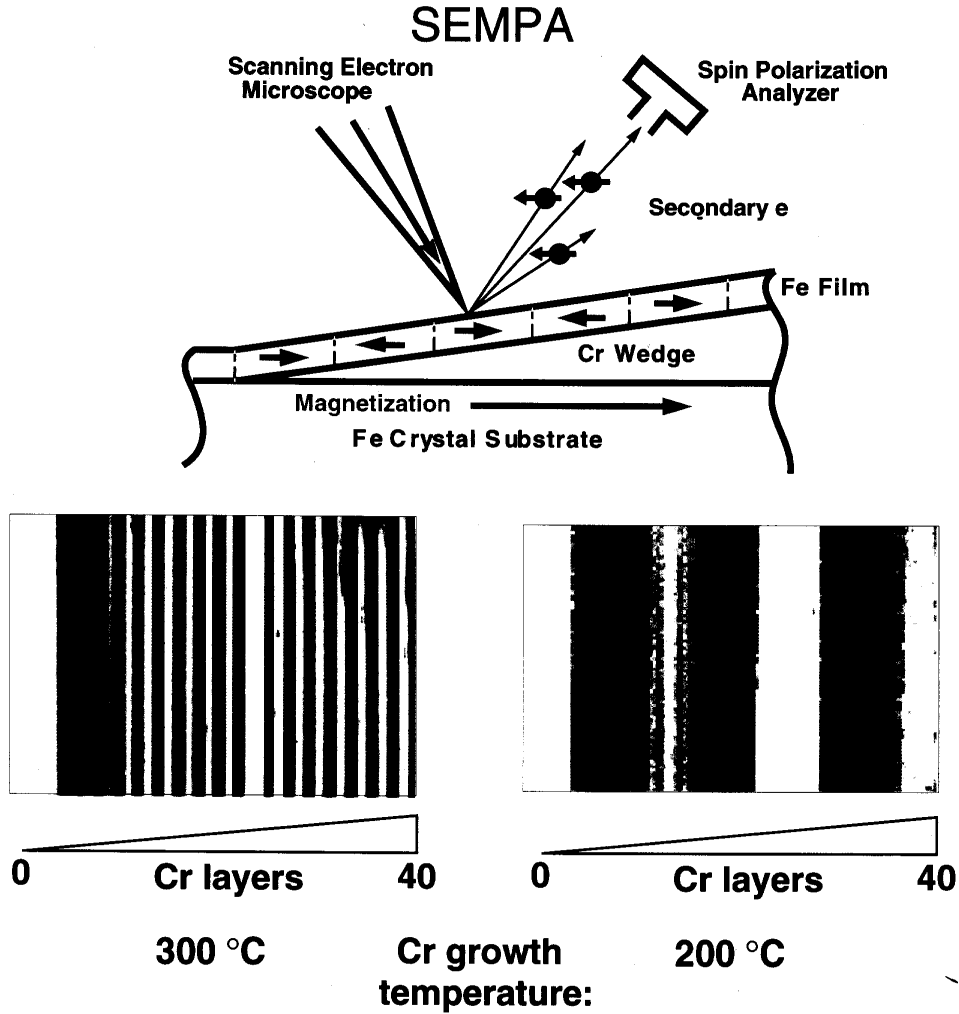

Fig. 3. In scanning electron microscopy with polarization analysis (SEMPA) the spin polarization of secondary electrons generated by a moving SEM beam is measured to obtain an image of the magnetization. Two such images of the magnetization of the top layer of a Fe/Cr (wedge)/Fe(001) sandwich are shown at the bottom of the figure for growth of the Cr wedge on the Fe whisker substrate at 200 °C and 300 °C. White (black) shows that the top Fe layer is coupled ferromagnetically (antiferromagnetically) to the Fe substrate.

Our discussion of the impact of *GaAs Spin-Polarized Electron Source* has so far been restricted to examples from condensed matter physics. At the time of publication of this paper, there were also experiments in the area of electron-atom collision physics just waiting for such a spin-polarized electron gun. When polarization techniques are used to fully state select the target and the incident electron polarization, then a complete or “perfect” scattering experiment is possible. In this case the quantum amplitude and phases can be measured instead of the cross-sections. Since cross-sections are sums of squares of complex amplitudes, direct determination of the individual amplitudes provides a more helpful comparison to, and a much more stringent test of, theoretical models. Using a GaAs polarized electron

gun to scatter from a beam of Xe atoms, and measuring the change in polarization after scattering, the spin-orbit interaction was investigated in a complete experiment [15]. At NIST, the exchange interaction was carefully investigated in extensive experiments of elastic and inelastic polarized-electron scattering from state-selected Na beams [16].

GaAs Spin-Polarized Electron Source has been cited approximately 250 times, though nowadays the GaAs spin-polarized-electron gun is taken as accepted technology and its origins are often no longer cited. As discussed in a 1995 review [17], for most atomic and condensed matter experiments, the polarized electron gun described in *GaAs Spin-Polarized Electron Source* is more than adequate and remains the source of choice.

GaAs polarized-electron sources for experiments in the areas of nuclear and particle physics, while working on the same principle, have been developed specifically to meet particular accelerator requirements such as a very high cathode voltage or a particular time structure of the beam. Advances over the years in GaAs type polarized electron sources, especially the progress toward higher polarization while maintaining sufficient beam intensity, can be attributed in large part to the demanding requirements on polarized electron sources for accelerator applications. Spin-polarized electrons play a crucial role in many particle physics experiments today.

The authors of *GaAs Spin-Polarized Electron Source* formed a strong team. The electron-optical design was led by Chris Kuyatt, assisted by Anija Galejs. Kuyatt was Section Chief of the Surface and Electron Physics Section at the time of the beginning of construction of the spin-polarized electron source. By the time the paper was published, he had become Chief of NIST's Center for Radiation Physics. In the 1960s, he and John Simpson developed high resolution electron monochromators and energy analyzers [18] and with them investigated sharp resonances in the electron transmission in gases [19]. The explanation of the resonance lineshapes is found in the landmark paper by Ugo Fano [20] (discussed elsewhere in this volume). Kuyatt worked at NIST until his death in 1998.

Robert Celotta, who became group leader after Kuyatt, and later a NIST Fellow, continues to do both research and serve as Group Leader of the Electron Physics Group. Dan Pierce also became a NIST Fellow and continues his research in the NIST Electron Physics Group. Together, Celotta and Pierce received the Edward Uhler Condon Award for distinguished achievement in written exposition as a result of their contribution to the paper *GaAs Spin-Polarized Electron Source*. They also shared the Department of Commerce Gold Medal and the American Vacuum Society Gaede-Langmuir Prize for their development of advanced, spin-polarized electron beam technology. Celotta and Pierce were given the first NIST William P. Slichter Award, which recognizes the growing need to promote cooperative partnerships between government and industrial researchers.

Stan Mielczarek and Anija Galejs worked as physicists in the Electron Physics Group until their retirements in 1990 and 1988 respectively. Bill Unertl was a National Research Council Postdoctoral Associate who left to take a faculty position at the University of Maine, where he is now Professor of Physics. Gwo-Ching Wang was a postdoctoral fellow and now is Professor of Physics at Rensselaer Polytechnic Institute.

The National Bureau of Standards received IR-100 Awards in 1980 and 1985 (selected by Industrial Research and Development Magazine as one of the 100 most significant technical innovations of the year) for a Surface Magnetometer and for an Electron Gun, both of which were outgrowths of the development described in *GaAs Spin-Polarized Electron Source*.

Prepared by Daniel T. Pierce and Robert J. Celotta.

Bibliography

- [1] D. T. Pierce, R. J. Celotta, G.-C. Wang, W. N. Unertl, A. Galejs, C. E. Kuyatt, and S. R. Mielczarek, GaAs Spin Polarized Electron Source, *Rev. Sci. Instrum.* **51**, 478-499 (1980).
- [2] D. T. Pierce, F. Meier, and P. Zürcher, Negative Electron Affinity GaAs: A New Source of Spin-Polarized Electrons, *Appl. Phys. Lett.* **26**, 670-672 (1975); D. T. Pierce and F. Meier, Photoemission of Spin-Polarized Electrons from GaAs, *Phys. Rev. B* **13**, 5484-5500 (1976); D. T. Pierce, F. A. Meier, and H. C. Siegmann, *Source of Spin Polarized Electrons*, U.S. Patent 3,968,376, issued July 6, 1976.
- [3] G.-C. Wang, B. I. Dunlap, R. J. Celotta, and D. T. Pierce, Symmetry in Low-Energy Polarized-Electron Diffraction, *Phys. Rev. Lett.* **42**, 1349-1352 (1979).
- [4] R. J. Celotta, D. T. Pierce, G.-C. Wang, S. D. Bader, and G. P. Felcher, Surface Magnetization of Ferromagnetic Ni(110): A Polarized Low-Energy Electron Diffraction Experiment, *Phys. Rev. Lett.* **43**, 728-731 (1979).
- [5] D. T. Pierce, R. J. Celotta, J. Unguris, and H. C. Siegmann, Spin-dependent Elastic Scattering of Electrons from a Ferromagnetic Glass, Ni₄₀Fe₄₀B₂₀, *Phys. Rev. B* **26**, 2566-2574 (1982).
- [6] J. Unguris, A. Seiler, R. J. Celotta, D. T. Pierce, P. D. Johnson, and N. V. Smith, Spin-Polarized Inverse Photoelectron Spectroscopy of Solid Surfaces: Ni(110), *Phys. Rev. Lett.* **49**, 1047-1050 (1982).
- [7] J. Kirschner, D. Rebenstorff, and H. Ibach, High-Resolution Spin-Polarized Electron-Energy-Loss Spectroscopy and the Stoner Excitation Spectrum in Nickel, *Phys. Rev. Lett.* **53**, 698-701 (1984); D. L. Abraham and H. Hopster, Spin-Polarized Electron-Energy-Loss Spectroscopy on Ni, *Phys. Rev. Lett.* **62**, 1157-1160 (1989).
- [8] E. Bauer, Low Energy Electron Microscopy, *Rep. Prog. Phys.* **57**, 895-938 (1994).
- [9] H. C. Siegmann, D. T. Pierce, and R. J. Celotta, Spin-dependent Absorption of Electrons in a Ferromagnetic Metal, *Phys. Rev. Lett.* **46**, 452-455 (1981).
- [10] R. J. Celotta, D. T. Pierce, H. C. Siegmann, and J. Unguris, An Electron Spin Polarization Detector: Spin-Dependent Absorption of a Polarized Electron Beam, *Appl. Phys. Lett.* **38**, 577-579 (1981).
- [11] J. Unguris, D. T. Pierce, A. Galejs, and R. J. Celotta, Spin and Energy Analyzed Secondary Electron Emission from a Ferromagnet, *Phys. Rev. Lett.* **49**, 72-76 (1982).
- [12] J. Unguris, D. T. Pierce, and R. J. Celotta, Low-Energy Diffuse Scattering Electron-Spin Polarization Analyzer, *Rev. Sci. Instrum.* **57**, 1314-1323 (1986).
- [13] J. Daughton, Non-volatile Electronics, private communication.
- [14] J. Unguris, R. J. Celotta, and D. T. Pierce, Observation of Two Different Oscillation Periods in the Exchange Coupling of Fe/Cr/Fe(100), *Phys. Rev. Lett.* **67**, 140-143 (1991).

- [15] W. Wübker, R. Möllenkamp, and J. Kessler, "Perfect" Elastic e^- -Xe Scattering Experiment, *Phys. Rev. Lett.* **49**, 272-275 (1982).
- [16] J. J. McClelland, M. H. Kelley, and R. J. Celotta, Spin-Dependent Superelastic Scattering from Pure Angular Momentum States of Na(3P), *Phys. Rev. Lett.* **56**, 1362-1365 (1986); J. J. McClelland, M. H. Kelley, and R. J. Celotta, Superelastic Scattering of Spin-Polarized Electrons from Sodium, *Phys. Rev. A* **40**, 2321-2329 (1989); S. R. Lorentz, R. E. Scholten, J. J. McClelland, M. H. Kelley, and R. J. Celotta, Spin-Resolved Elastic Scattering of Electrons from Sodium, *Phys. Rev. A* **47**, 3000-3006 (1993).
- [17] D. T. Pierce, Spin-Polarized Electron Sources, in *Atomic, Molecular, and Optical Physics: Charged Particles (Experimental Methods in the Physical Sciences 29A)*, F. B. Dunning and Randall G. Hulet (eds.), Academic Press, San Diego (1995) pp. 1-38.
- [18] C. E. Kuyatt and J. A. Simpson, Electron Monochromator Design, *Rev. Sci. Instrum.* **38**, 103-111 (1967).
- [19] C. E. Kuyatt, S. R. Mielczarek, and J. A. Simpson, Energy Losses and Elastic Resonances in Electron Scattering from H_2 , *Phys. Rev. Lett.* **12**, 293-295 (1964).
- [20] U. Fano, Effects of Configuration Interaction on Intensities and Phase Shifts, *Phys. Rev.* **124**, 1866-1878 (1961).

Needs for Radioactivity Standards and Measurements in Different Fields

This 1973 paper was written at a critical point in the development of applications of radioactivity and nuclear power, and it defined the needs of standards laboratories of the world for the remainder of the century. Although the paper [1] was co-authored by members of the Radioactivity Section, it was largely written by Wilfrid Mann and represents the fruition of his years of reflection on radionuclide metrology.

Standards are needed for radioactive materials to permit their accurate measurement for purposes of health, worker protection, and public safety. The National Bureau of Standards developed a program for standards and calibrations of radium-226 (1600 year half life) in the early part of the century [2,3], but this program was limited mainly to naturally-occurring radionuclides in the uranium and thorium series until the late 1940s. Following World War II, man-made radionuclides from reactors, linear accelerators, and cyclotrons became available for more routine uses in medicine, agriculture, and industry. The Bureau then began development of primary standardization techniques that could be applied to classes of radionuclides, such as pure beta-particle emitters [4], gamma-ray emitters, and alpha-particle emitters. In 1951, Lauriston S. Taylor envisioned a world-leadership role for NBS in radionuclide metrology and recruited Wilfrid Mann from the Chalk River laboratories in Canada. Throughout the 1950s and 1960s Mann built and expanded the Bureau's capabilities in radionuclide metrology [5], including techniques such as microcalorimetry, beta-gamma coincidence counting, gas counting, defined solid-angle alpha counting, and photon spectrometry. Metrology also required developing expertise in sample preparation, radiochemistry, isotope separation, sampling for environmental analyses, and measurement quality assurance. Thus, by the end of the 1960s NBS was ready to assume national leadership in measurements for radioactivity, and a timely report from the National Academy of Sciences [6] stressed the needs for radioactivity standards for public health, medicine, and nuclear science.

Needs for Radioactivity Standards was written just as the applications of radiopharmaceuticals in nuclear medicine were beginning a very rapid expansion. During the same period, the U.S. nuclear industry (and the industrialized world) were very positive about the prospects for cheap, abundant "atomic energy," and the utilities were building new nuclear power stations all

over the country. Most of the 104 power reactors operating today were ordered during the 1970s. In each of the national standards laboratories, metrologists were considering how to meet the needs of these emerging technologies. This paper was the keynote presentation of the formative meeting of the International Committee for Radionuclide Metrology (ICRM). The paper both summarizes the status of radionuclide standards and explores the needs for standards, measurements, and traceability for the emerging fields of nuclear medicine and nuclear power. It provided a blueprint for national and international traceability.

In the first nine pages Mann laid the foundation for radionuclide metrology by introducing the concepts, terminology and historical developments of measurement standards and radioactivity standards. This entertaining and informative introduction was absolutely necessary to his later development of the concept of *traceability*. He points out that "criterion" and "standard" are synonyms in the English language. Criterion comes from the Greek, while standard is derived from the old French "estandard." It was a flag raised on a pole to indicate the rallying point of an army. Our battlefields of today have shifted from armed combat to economic warfare, and this sense of the word standard still resonates with U.S. industry. Derived standards of radioactivity differ from the base quantities of time, length, and mass in two important respects. First, radioactivity is an ephemeral quantity. The substance is decaying with some half life (a good example is the 6 hour half life ^{99m}Tc used in nuclear medicine) such that often the material no longer exists after the measurements are completed. In most cases, the standard must reside in a system (protocol, people, detector, and associated electronics) that can be used to measure a disintegration rate (activity) from first principles. Second, there are a few thousand radionuclides, and they are found in many matrices (gas, liquid, solid, soil, air filters), so that choices must be made on the select few nuclides and matrices for "national standards." *Needs for Radioactivity Standards* addressed the basic issues of identifying emerging technologies, ordering priorities, developing measurement quality assurance programs, and establishing traceability for key measurements at the national and international levels. Following the historical background, Mann gave special emphasis to needs for radiopharmaceuticals and for monitoring radioactivity in the environment.

In the area of radiopharmaceuticals, NBS was forging ties directly to the manufacturers and to professional medical groups, such as the College of American Pathologists (CAP), as well as to the Food and Drug Administration (FDA). This paper reported some of the first round-robins with clinical users for solution standards of the radionuclides ^{51}Cr , ^{59}Fe , and ^{131}I . These first sets of measurements were evaluated by the manufacturers, FDA, and the professional groups. It was readily agreed that such exercises were important to establish mutual trust between manufacturers and with the FDA drug reviewers. For the small group of manufacturers, equity-in-trade was an important consideration. Bulk radionuclides were routinely produced and sold as raw materials, and a few percent discrepancy in the assay between manufacturers could lead to thousands of dollars in disputed sales. Thus, a small expenditure on a common program at NBS would ensure that all parties were measuring the same quantity of activity. The FDA had a need to verify the calibrations of the suppliers as well. If they were in the same calibration program with the manufacturers, it would simplify their work on audits for quality control. However, the CAP did not have a mechanism for a long-term formal program in this area. Wilfrid Mann and Lucy Cavallo negotiated with the industry to set up a consortium of radiopharmaceutical manufacturers in North America to produce such standards on a continuing basis under the auspices of the Atomic Industrial Forum [7].

During the 1970s and 1980s this program addressed the critical needs of the industry for short-lived radionuclide standards for diagnostic imaging in nuclear medicine. One of the most difficult of these standardizations was the 6 hour half life $^{99\text{m}}\text{Tc}$. It has long been the most important nuclide in terms of diagnostic imaging and accounts for over 90 % of the 13 million applications per year in the United States. Technetium-99m, a metastable form of technetium-99, is produced by a chemical extraction from a ^{99}Mo - $^{99\text{m}}\text{Tc}$ generator, and the product must be purified to eliminate traces of the 67 hour parent nuclide. The logistical hurdles were also severe, as air cargo shipping of radioactive materials with a six hour half life before the days of rapid commercial air freight was problematic. Lucy Cavallo worked out the rapid procedures for chemical separations and source preparations for these two nuclides, and Robert Ayres and Alan Hirshfeld later reported on the standardization by $4\pi\beta$ - γ coincidence counting [8]. These protocols for rapid standardization of high activity levels of radionuclides, developed by Lucy Cavallo and Ronald Collé, were adopted by industry and are still in use today. The program continued to expand and

added approximately one new nuclide each year; at present, there are 28 radiopharmaceutical SRMs [9]. Ten of these 28 SRMs are distributed each year.

After 1987 the focus shifted towards radionuclides for use in therapy. Radionuclides have been used in therapy for many years, but in the recent past improvements in sealed source preparation and radiopharmaceutical targeting strategies have led to much greater use and, accordingly, demands for standards. An example of the continuing leadership of NIST in this area was the recent international workshop organized by Bert Coursey and Brian Zimmerman to identify the needs for standards for therapeutic nuclides [10]. The long-term impact of the NBS/NIST radiopharmaceutical standards program was evaluated recently in an economic impact study by Albert Link [11], who found that this program had a 97 to 1 benefit to cost ratio based solely on the economic benefits. The benefits in terms of improved quality of health care (better diagnostics, more effective therapies) to the U.S. public are even more significant than the economic benefits.

Prior to this 1972 conference, Mann had established competence at the Bureau on low-level radioactivity measurements, which are important for environmental monitoring. J.M.R. (Robin) Hutchinson had developed a number of low-level counting instruments [12] for gamma-ray and alpha-particle emitters, and Lloyd Currie had considered the statistics of low-level counting [13], with an experimental emphasis on ^3H and ^{14}C . In 1963, Currie transferred to the Analytical Chemistry Division and has achieved international prominence in atmospheric carbon measurements.

Needs for Radioactivity Standards reported on a new and very promising program for gamma-ray emission-rate SRMs for use in the emerging nuclear power industry. In early 1972, there were serious disagreements between the Atomic Energy Commission (AEC) and the new Environmental Protection Agency (EPA) on how to analyze liquid effluents from the six operating nuclear power stations. A meeting was organized at Oyster Creek nuclear power station in Tom's River, New Jersey, in February 1972 that included the AEC, the EPA, the New Jersey radiation health authorities, the utility, and Robin Hutchinson and Bert Coursey from NBS. It was decided that NBS would prepare mixed gamma-ray standard sources which would be used by all participants to calibrate their Ge(Li) spectrometers. Participants then received a set of blind samples from NBS which they measured as unknowns, and then reported their results to NBS. This very successful exercise led quickly to production of a set of Standard Reference Materials. The gamma-ray spectrum from one of these early SRMs is shown in Fig. 1. The nine principal lines

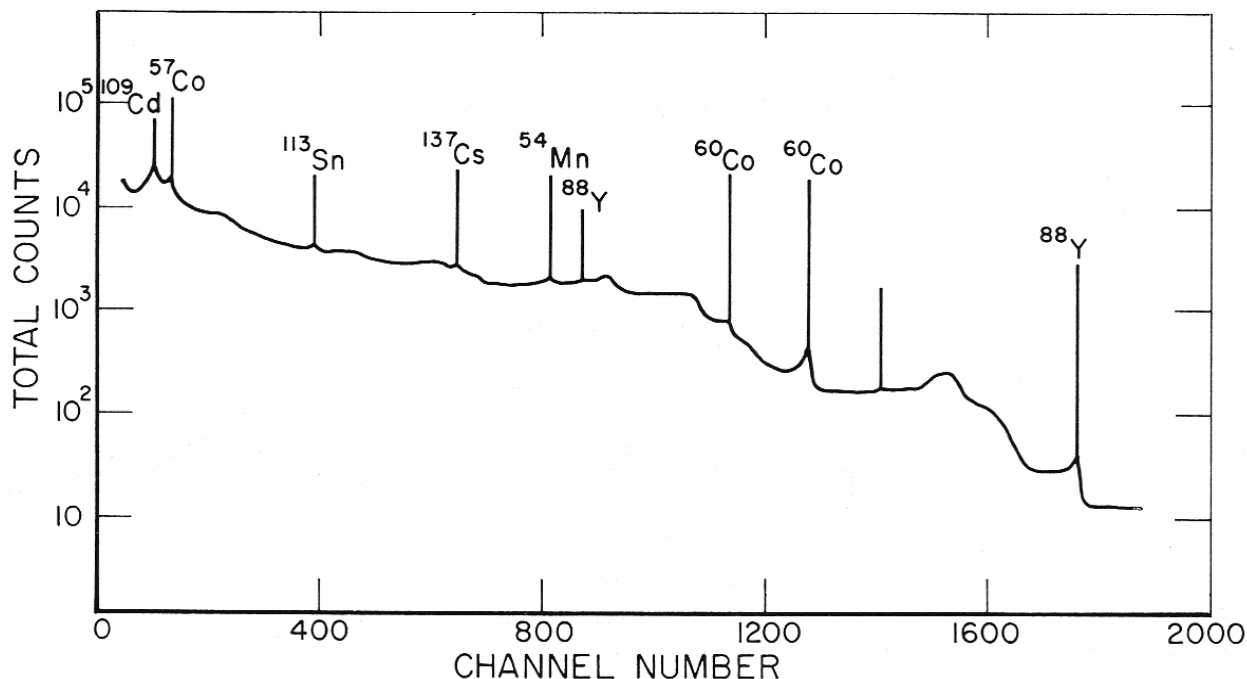

Fig. 1. Gamma-ray spectrum of a mixed radionuclide standard obtained with a 50 mL source positioned 2.54 cm from a 11 cm³ Ge(Li) detector. Figure 9 in reference [1]. The lowest energy calibration point is the 88.0 keV gamma ray from ¹⁰⁹Cd, and the highest energy point is the 1836 keV gamma ray of ⁸⁸Y.

in the spectrum correspond to emissions from seven nuclides which were mixed in the proportions that the peak areas were approximately the same for a given counting time. This allowed the user to calibrate the system for all gamma-ray emitting fission and activation products at one time.

Hutchinson built on this example and organized a wider group of laboratories to consider the more difficult problems of environmental radioactivity in natural matrices. This led to a meeting of the International Committee on Radionuclide Metrology (ICRM) at Woods Hole, Massachusetts, in October of 1977. Participants considered the global problem of radioactivity in the environment and the standards that would be needed, as well as the required research in radiochemistry and the physics of low-level counting. Recommendations were made to produce standards of biological materials, soil, sediments, and waters, each to be certified for as many radionuclides as possible [14]. Hutchinson recruited Kenneth Inn, a young chemist from Arkansas, to take the lead on design of sampling and preparation of these natural matrix SRMs. One of the most popular of these was the Rocky Flats Soil SRM 4353 [15]. They quickly found that the man-made plutonium isotopes were not homogeneously distributed in the material (as the natural uranium and thorium

were). This was due to the presence of hot particles in the soil from operations at the Rocky Flats plant in Colorado. In the past when Mann had encountered statistical problems in data analysis, he had turned to Bureau statisticians W.J. Youden and H.H. Ku. To help with the statistical analyses of these new data, Hutchinson and Inn turned to Walter Liggett and James Filliben. Their joint papers [15] provide a model for the interpretation of data from small samples near nuclear facilities (for example, swipe samples taken from nuclear facilities during International Atomic Energy Agency inspections).

Many of the NIST technical groups have to deal with the concepts of traceability to NIST. Mann recognized that this would be a critical problem for the nuclear industry, and that there would be slightly different requirements from the pharmaceutical industry, the nuclear utilities, the AEC (later DOE) laboratories, and those interested in environmental measurements. The direct and indirect traceability that he articulated in *Needs for Radioactivity Standards* had the common thread that one had to participate in a hierarchical measurements system which involved periodic blind testing of the laboratory's capabilities in order to assure traceability. The key federal regulators—the FDA for pharmaceuticals, the EPA for the environment, and the

Nuclear Regulatory Commission (NRC) for the power stations—accepted these definitions from NBS and worked with NBS and the user communities to set up measurement assurance programs and, later, accredited calibration laboratory programs to meet the common needs of the users and the regulators, with NBS serving as an impartial third party to prepare the SRMs and solve critical measurement problems. This paper has been widely cited in the U.S. and the international community for the past quarter century as the White Paper on achieving traceability in radioactivity measurements. A few of those present at that first meeting at Oyster Creek in 1972 were on the ANSI Subcommittee N42.2 that prepared an American National Standard—*Traceability of Radioactive Sources to the NIST and Associated Instrument Quality Control* [16].

Wilfrid Mann was born in Ealing in the United Kingdom on August 4, 1908. He received his Doctorate in Physics from Imperial College of Science and Technology in London in 1937 and did postdoctoral work during the 1930s in Copenhagen and Berkeley. While at Berkeley he worked with E. O. Lawrence on the cyclotron in the Radiation Laboratory and was the discoverer of the radioisotope ^{67}Ga , which is still in use in nuclear medicine [17]. His supervisor at Imperial College was G. P. Thompson, the British physicist in charge of the Tube Alloys project during the war years (the British nuclear program which was incorporated into the Manhattan Project). He had Mann assigned to the British Embassy in Washington. His interactions with his supervisor at the Embassy, Kim Philby, and another coworker there, Guy Burgess, gained Wilfrid considerable notoriety when the two were implicated in one of the biggest spy scandals of the century. In memoirs written much later [18], Wilfrid was able to show that he was not involved in nuclear matters while stationed in Washington and could not have taken part in their nefarious activities. Following his tour in Washington, Thompson assigned Mann to work with Sir John Cockcroft at the Canadian nuclear facilities at Chalk River. At this point he began careful measurements to intercompare the national radium standards of the UK, Canada, and the United States. This work was continued when he came to NBS in 1951 as the head of the Radioactivity Section. For the next 40 years Wilfrid Mann was one of the most influential researchers in his field. At intervals of a few years over this period of four decades Mann prepared books, handbooks, and extended monographs to describe completely the current state of the art in radionuclide metrology. The first of these were NBS Circular 594 [4] in 1958 and NBS Handbook 80 in 1961 [19]. These were followed by a book *Radioactivity and Its Measurement* with

Samuel Garfinkel in 1966 and an expanded second edition with Robert Ayres in 1980 [20]. Following his retirement from NBS in 1980, he collaborated with Albrecht Rytz and Alfred Spagnol on *Radioactivity Measurements: Principles and Practice* [21]. Perhaps his most lasting contribution to metrology was the monumental task of editing *A Handbook of Radioactivity Measurements Procedures* [22], NCRP Handbook 58. The first edition was published in 1978; the second in 1985 sold more copies than any other handbook of the NCRP and set out the principles of radionuclide metrology for a generation.

Prepared by Bert Coursey.

Bibliography

- [1] L. M. Cavallo, B. M. Coursey, S. B. Garfinkel, J. M. R. Hutchinson, and W. B. Mann, Needs for Radioactivity Standards and Measurements in Different Fields, *Nucl. Instrum. Methods* **112**, 5-18 (1973).
- [2] N. Ernest Dorsey, *Physics of Radioactivity*, Williams and Wilkins, Baltimore, MD (1921).
- [3] Bert Coursey and Johnathan Coursey, *Marie Curie and the NBS Radium Standards*, (<http://www.physics.nist.gov/GenInt/Curie/main.html>), National Institute of Standards and Technology.
- [4] H. H. Seliger and A. Schwebel, Standardization of Beta-Emitting Nuclides, *Nucleonics* **12** (7), 54-63 (1954).
- [5] W. B. Mann and H. H. Seliger, *Preparation, Maintenance, and Application of Standards of Radioactivity*, National Bureau of Standards Circular 594, U.S. Government Printing Office, Washington, DC (1958).
- [6] Ad Hoc Panel (L. R. Zumwalt, Chair) of the Committee on Nuclear Science, National Research Council, (U.S.), *National Uses and Needs for Standard Radioactive Materials: A Report*, National Academy of Sciences, Washington, DC (1970).
- [7] R. Collé, AIF-NBS Radioactivity Measurements Assurance Program for the Radiopharmaceutical Industry, in *Measurements for the Safe Use of Radiation*, Sherman P. Fivozinsky (ed.), NBS Special Publication 456, National Bureau of Standards, Washington, DC (1976) pp. 71-76.
- [8] Robert L. Ayres and Alan T. Hirshfeld, Radioactivity Standardization of $^{99\text{m}}\text{Tc}$ and ^{99}Mo , *Int. J. Appl. Radiat. Isot.* **33**, 835-841 (1982).
- [9] Daniel B. Golas, NIST Radiopharmaceutical Standard Reference Materials and the NEI/NIST Radiopharmaceutical Measurement Assurance Program, *Appl. Radiat. Isot.* **49**, 329-334 (1998).
- [10] B. M. Coursey, *Radionuclides for Bone Palliation*, Special Issue of *Appl. Radiat. Isot.*, Vol. 49, No. 4, April 1998.
- [11] A. N. Link, *Economic Evaluation of Radiopharmaceutical Research at NIST*, Planning Report 97-2, National Institute of Standards and Technology, Gaithersburg, MD (1997); and B. M. Coursey and A. N. Link, Evaluating Technology Based Public Institutions: The Case of Radiopharmaceutical Standards Research at the National Institute of Standards and Technology, *Res. Eval.* **7**, 147-157 (1998).
- [12] J. M. R. Hutchinson, W. B. Mann and P. A., Mullen, Sum-Peak Counting with Two Crystals, *Nucl. Instrum. Methods* **112**, 187-196 (1973).
- [13] Lloyd A. Currie, Limits for Qualitative Detection and Quantitative Determination. Application to Radiochemistry, *Anal. Chem.* **40**, 586-593 (1968).

- [14] J. M. R. Hutchinson, International Committee for Radionuclide Metrology Newsletter: Report of the Woods Hole Conference on Development of Naturally Contaminated Radioactivity Standards, *Environ. Int.* **2**, 49-50 (1979).
- [15] K. G. W. Inn, W. S. Liggett, and J. M. R. Hutchinson, The National Bureau of Standards Rocky Flats Soil Standard Reference Material, *Nucl. Instrum. Methods* **223**, 443-450 (1984).
- [16] American National Standard—*Traceability of Radioactive Sources to the National Institute of Standards and Technology (NIST) and Associated Instrument Quality Control*, ANSI N42.22-1995, Institute of Electrical and Electronics Engineers, New York (1995).
- [17] Wilfrid B. Mann, Nuclear Transformations Produced in Zinc by Alpha-Particle Bombardment, *Phys. Rev.* **54**, 649-652 (1938).
- [18] Wilfrid Basil Mann, *Was There a Fifth Man?: Quintessential Recollections*, Pergamon Press, Oxford (1982).
- [19] W. B. Mann (ed.), *A Manual of Radioactivity Procedures*, National Bureau of Standards Handbook 80 (NCRP Report No. 28), U.S. Government Printing Office, Washington, DC (1961).
- [20] W. B. Mann, R. L. Ayres and S. B. Garfinkel, *Radioactivity and Its Measurement, Second Edition (SI Units)*, Pergamon Press, Oxford (1980).
- [21] W. B. Mann, A. Rytz, A. Spernol, and William L. McLaughlin, *Radioactivity Measurements: Principles and Practice*, Pergamon Press, Oxford (1988).
- [22] W. B. Mann (ed.), *A Handbook of Radioactivity Measurements Procedures, 2nd Edition*, (NCRP Report No. 58) National Council on Radiation Protection and Measurements, Bethesda, MD (1985).

The Topografiner: An Instrument for Measuring Surface Microtopography

Russell Young, John Ward, and Fredric Scire published their paper on the topografiner in 1972 [1]. Nearly 30 years later, it is tempting to say that scanning probe microscopy (SPM) needs no introduction. The number of papers concerning this technique is now approaching 5000 per year (Fig. 1), so that hardly any technical professional with an interest in microscopy can have escaped acquaintance with one or more of its variants. The explosion of SPM activity began after publication of atomic resolution images of silicon [2] in 1983 and the award of the Nobel Prize in Physics to Binnig and Rohrer in 1986 made scanning tunneling microscopy (STM) famous. Today, SPM has found applications in physics (e.g., crystal and surface electronic structure of metals and semiconductors, superconductivity, liquid crystals), chemistry (e.g., catalysis, electrochemistry, Langmuir-Blodgett films, polymer morphology), biology (structure of nucleic acids, cells, proteins, lipids, etc.) and other fields. A recent chemistry-oriented review [3] referenced 33 other SPM-related reviews and books published in the preceding 2-year period alone!

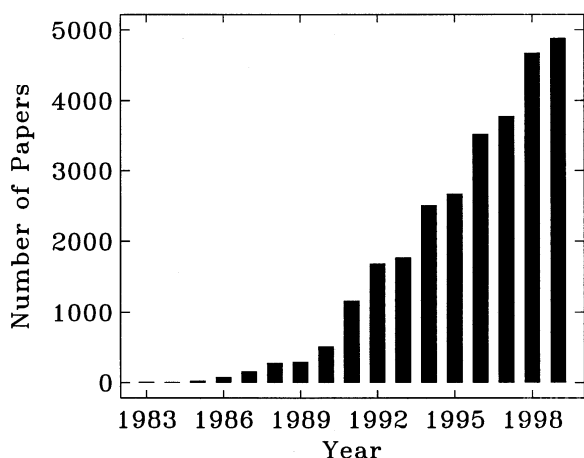

Fig. 1. Growth of publications in scanning probe microscopy, as determined by searching the ISI Science Citation Index.

There are four essential elements of a scanning probe microscope that distinguish it from other microscopes: 1) a very sharp mechanical probe, the tip of which is maintained in close proximity to the sample surface;

2) detection of a surface property (e.g., a tunneling current) that changes rapidly in the vicinity of the surface and therefore provides a very sensitive indicator of the tip-sample distance; 3) use of an electronic feedback system to control the tip-sample distance or to maintain a controlled low-force contact—essential to prevent damage to the sharp tip; and 4) the ability to position the tip with respect to the sample in three dimensions with sub-nanometer resolution, as for example through the use of piezoelectric devices. In the earliest implementations, a voltage was applied between the tip and a conducting sample. The feedback system maintained the resulting field emission or tunneling current at a constant value by adjusting the tip height as needed. The tip was then raster-scanned laterally across the surface (Fig. 2). The feedback loop responded by moving the tip normal to the surface, thereby tracing the surface topography at constant current and therefore approximately constant tip-sample separation. The resulting adjustments to the tip position were monitored, and they formed a record, to first approximation, of the surface topography. Other scanning probe microscopies use other near-surface properties, for example tip-sample force (AFM) or capacitance (SCM). Sometimes one property is monitored for feedback purposes while the image is formed from another, as in NSOM (near-field scanning optical microscopy).

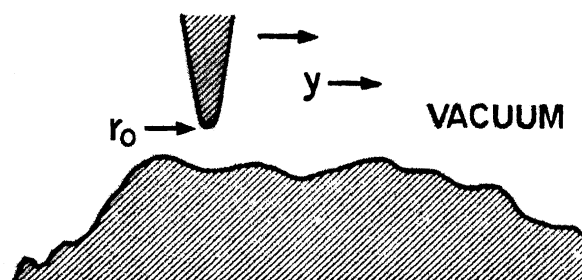

Fig. 2. Scanning the tip across a surface. This figure is from Ref. 4, where the concept of what eventually became the topografiner was first described.

The first successful scanning probe microscope was Russell Young's topografiner [1]. In this instrument, a field emission current between the tip and sample was employed for feedback control. The Royal Swedish

Academy of Sciences' press release announcing Binnig and Rohrer's Nobel prize for the scanning tunneling microscope gave substantial attention to Young's work: "The first to succeed in doing this [building an instrument that operated on the principle of maintaining a small constant distance between the sample surface and a sharp mechanical stylus] was the American physicist Russell Young at the National Bureau of Standards in the USA. He used the phenomenon known as field emission . . . However, Young realized, that it should be possible to achieve better resolution by using the so-called tunnel effect." [5]

A schematic of the topografiner is shown in Fig. 3. The specimen was mounted between spring-loaded copper clamps. This permitted thin specimens, for example replicas, to be held taut. An electrical current through the specimen could heat it for cleaning. A tungsten tip was attached to molybdenum bridges between two molybdenum rods. The emitter could be heated for cleaning by passing current through the bridges to which it was attached. The emitter assembly was mounted on a vertical "piezo." Piezoelectric ceramic materials expand and contract with applied voltage, producing continuously controllable motion with subnanometer resolution and a typical range of a few micrometers. The sample was brought into range of this device using a differential screw, which itself had a range of a bit more than 250 μm . The sample and tip were originally placed within this distance of each other manually, using an optical microscope to view the tip-sample separation and making coarse adjustments using the threaded connection in the tube that joined the tip assembly to the specimen assembly. The X and Y scan piezos deflected the rod supporting the emitter, thereby producing motion of the tip in the plane of the specimen.

The tip-sample separation was maintained by a feedback controller that adjusted the voltage on the vertical piezo to maintain a constant current through the tip-specimen junction. To form the images, the voltage applied to this piezo was recorded with either an x - y recorder or a storage oscilloscope during scanning. Unlike later STMs, the topografiner was rigidly attached to its vacuum chamber. Vibration isolation was all external. The chamber was mounted on a vibration isolation table and enclosed by an acoustical shield. Inside, a pressure of about 5×10^{-8} Pa (4×10^{-10} Torr) was maintained.

Young et al. discussed several tip-sample interactions. Two of these, field emission and metal-vacuum-metal tunneling, were explored in some detail. When the electric field in the vicinity of the tip is high enough, electrons may tunnel from the metal tip through the work-function barrier into nearby vacuum states. The

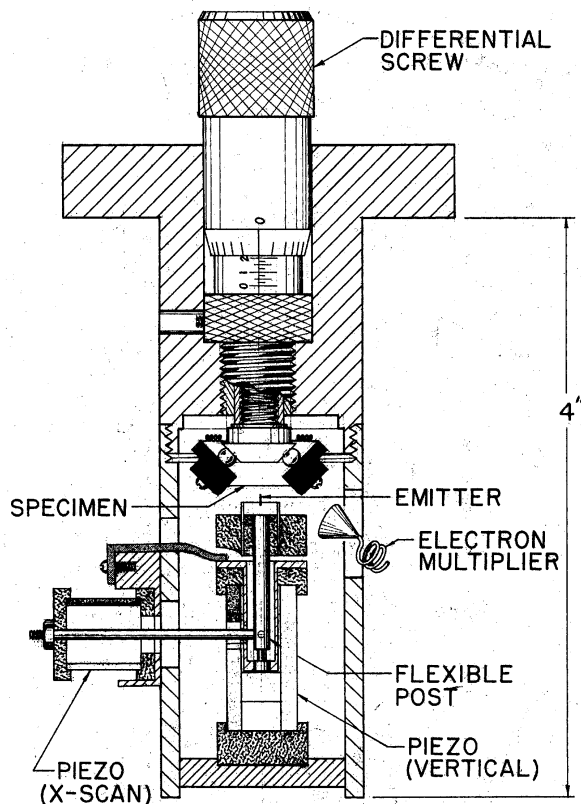

Fig. 3. Schematic of the topografiner (from Ref. [1]).

amount of current is governed by the Fowler-Nordheim equation. This form of tunneling can work even at large tip-sample distances, provided the potential difference is kept high enough to create a large enough field. In metal-vacuum-metal (MVM) tunneling, the tip and sample are sufficiently close that electrons can tunnel directly from one to the other. It was with this form of tunneling that STMs later resolved individual atoms on surfaces. Young et al. calculated that for the field and work function expected for their operating conditions and tip, MVM tunnel current became an important contribution for tip-sample separations less than 2 nm and completely dominated the measured current by 1 nm.

With the servo loop inactive, Young et al. measured current-voltage (I - V) curves at a variety of tip-sample separations, which they estimated ranged from 1.2 nm to 2.7 nm. At the lowest separation, they were measuring currents of up to 5 nA at voltages below 0.5 V. These conditions would be widely regarded in light of present-day experience with STMs as being well within the MVM tunneling regime, supporting their claim [1,6] that these were the first recorded MVM I - V curves. They mention several applications of MVM studies, including the measurement of tunneling spectra, thus anticipating scanning tunneling spectroscopy, which was implemented by others in the early 1980s.

Despite the recognized advantages, the instrument was not operated closed loop in the MVM tunneling mode because of vibrational noise and instability in the feedback electronics in that mode. Instead, images were acquired in field emission mode. A section of the paper was devoted to demonstrating that the measurements were consistent with Fowler-Nordheim tunneling. The imaging capability was demonstrated on a 180 line/mm diffraction grating replica (Fig. 4). Young et al. estimated the resolution to be 3 nm perpendicular to the surface and 400 nm in the plane. They estimated the instrument was capable of an ultimate resolution of 0.3 nm (one atomic layer) perpendicular to the surface, limited by noise, and 20 nm in the lateral direction, limited by tip radius.

In yet another imaging mode, secondary electrons generated by the field emitted electrons upon impact with the sample were collected by a nearby electron multiplier (see Fig. 3). The secondary yield as a function

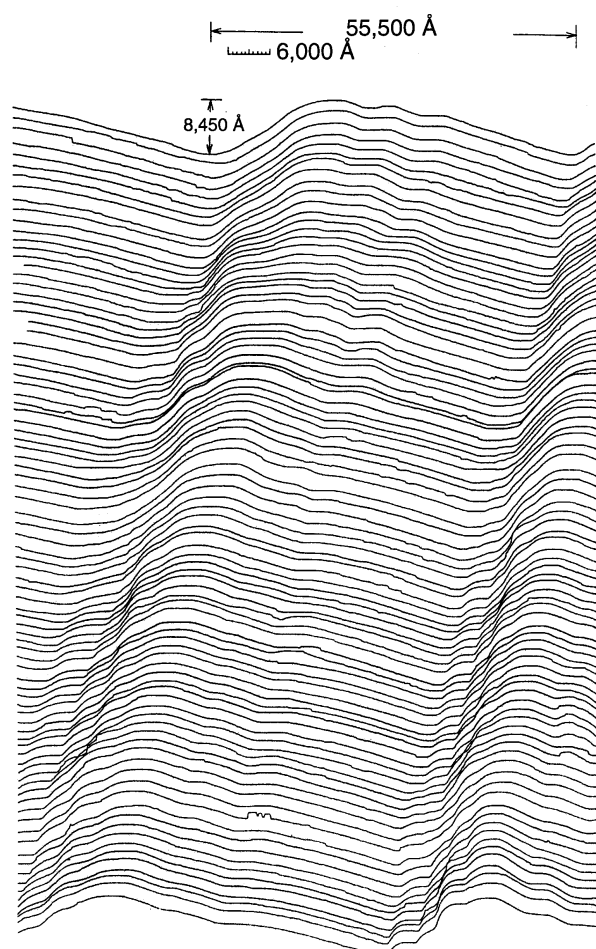

Fig. 4. Topographic map of ruled diffraction grating with the Topografiner. Labeled distances are in ångströms. 1 Å = 0.1 nm. (From Ref. [1]).

of tip position produced an image of the surface analogous to that created in a scanning electron microscope. This is interesting because it implements an imaging mode in which a property of the surface other than the one being employed by the feedback system is used to create images. The detector does not need to have focusing optics in order to determine the source of the particles because the tip localizes the excitation. This mode anticipated similar strategies employed later, for example the collection of photons generated at the tunnel junction of an STM.

The development of the topografiner began in the context of a burst of surface studies following World War II, when many new surface analysis techniques were becoming available. In the late 1960s surface scientists sought to study single-crystal surfaces, where theory and experiment could be compared in the study of corrosion, catalysis, surface electronic properties, and other surface properties of importance to the nascent microcircuit industry.

At NBS, Young collaborated closely with other surface scientists (see the account in this volume on *Resonance Tunneling of Field Emitted Electrons through Adsorbates on Metal Surfaces*). The seeds of the ideas leading to the topografiner are discernible in Young's prior experiences. Before receiving his B.S. degree in physics, he served in the military for three years during World War II. Concerning this time, he said, "I used radar to automatically track enemy planes and simultaneously direct antiaircraft guns to intercept them. Tight servo loops were used to lock in the plane's position. I had previously studied television theory which uses a raster scan to form the picture." During and immediately after his Ph.D. studies, he was active in the study of field emission, attracting wide attention, for example, for an important paper on the energy distribution of emitted electrons as a probe of the electronic state of surfaces [7]. It was natural, given his search for a new surface characterization microscope, for Young to combine these technologies.

In 1966, Young investigated and published the performance of an instrument he called the field emission ultramicrometer [4]. This was a device for sensing surfaces with a field emission tip and measuring distances or displacements. It resembled the topografiner in its use of field emission as a probe of tip-sample separation, but did not use feedback to control the separation and did not have the capacity to scan the tip in the plane of the sample. In the final figure of that paper, part of which is reproduced here as Fig. 2, Young suggested the addition of these elements to create a microscope with extremely high vertical resolution that could record the detailed contour of a complex surface.

In 1969 a project to carry out this plan was approved by NBS management. Young was able to employ a technician, Fredric Scire. Starting with the availability of laboratory space in 1970, Scire and Young worked closely together designing, constructing, testing, and publishing the topografiner investigation. John Ward joined the project after the instrument had been substantially constructed. He developed tip preparation methods and performed early experiments on operation of a field emission probe in air. The electronic characteristics and sensitivity of the topografiner, and the observation of metal-vacuum-metal tunneling with it, were described in 1971 [6]. The instrument's first published images were included in Young's review of surface microtopography techniques for *Physics Today* [8]. In July of 1971, shortly before publication of those articles, NBS management terminated the topografiner project to concentrate effort into a program to provide calibration artifacts to the microcircuit industry. The final design of the instrument, together with the theory of its operation and its actual performance, were afterwards published in the title paper [1].

Today, we have the advantage of many years of instrument development, tens of thousands of publications by researchers all over the world, and the commercial production of SPMs, which have become a ubiquitous and relatively inexpensive tool. But Young and his coworkers were breaking new ground with the topografiner, not following any existing recipe. If first attempts teach anything, then second attempts must be better, so it is no surprise that the topografiner had deficiencies compared to current instruments. But the remarkable thing, from the perspective of a modern SPM researcher, is the soundness of judgement with which Young, Ward, and Scire analyzed the deficiencies of their own instrument and planned improvements to it.

For example, the topografiner differed from current implementations of the STM by the absence, in the topografiner, of a logarithmic or otherwise variable amplifier in the feedback control circuit. With the benefit of experience, we can say that this is most likely the reason the topografiner's feedback control became unstable in MVM tunneling mode. The exponential increase of tunnel current with decreasing tip-sample separation means the servo loop gain increases exponentially as the tip enters tunneling range. The high gain coupled with inevitable mechanical resonances results in an unstable amplifier condition. Remarkably, Young had correctly diagnosed the problem. The paper included a graph of servo loop gain for various tip-sample separations and described the resulting instability. At the time the project was cancelled Young's proposed program included a task to "Develop improved servo loop with ability to handle variable gain feature

inherent in field emission devices . . ." [9]. This improvement alone might have made possible the acquisition of images in MVM tunneling mode.

The instrument also had in common with Binnig and Rohrer's first STM a rather soft mechanical loop. The resulting low resonance frequencies exacerbate feedback loop stability problems, forcing the instrument to be operated at lower scan rates. Later instruments raised the mechanical resonance frequency by reducing the amount of mass that had to be moved by the z piezo and making the mechanical loop between the sample and the tip as small as possible. Young et al. commented in their section on the servo loop that "these mechanical resonances, which must be eliminated in the next generation of the instrument, cause phase shifts and thus servo loop instabilities."

As mentioned earlier, the topografiner was rigidly attached to its vacuum chamber. Beginning with Binnig and Rohrer, vibration isolation systems for SPMs include an isolation level between the instrument and its vacuum chamber (if there is one). This greatly reduces the transmission of acoustical noise, picked up by the large vacuum chamber, to the instrument. Instead, the topografiner was surrounded by an acoustical isolation shell. Even without internal vibration isolation, the topografiner demonstrated noise levels as low as 0.3 nm. This level of noise would not have prevented scanning in MVM tunneling mode, and its reduction would have been an evolutionary improvement.

The achievements of the project are better appreciated by reflecting upon some of the difficulties with which the principals had to contend. The topografiner did not have computerized data acquisition, taken for granted in today's instruments. The first integrated circuit computers were only beginning to be available at the time of the project (The PDP 8 was introduced in 1970), so data acquisition was with x - y recorder and storage oscilloscope. Feedback circuitry was a challenge. Severe funding limitations prevented the purchase of modern electronic equipment.

Perhaps chief among their difficulties was the difficulty inherent in being the first in any exploration. One to a certain extent stumbles around in the dark, aware of some goals without knowing precisely how to reach them and perhaps completely unaware of other treasures that may lie within reach. One such was atomic resolution. The possibility of laterally resolving individual atoms by such a technique was not suspected by anyone at that time. Young et al., and later Binnig and Rohrer, at first viewed tips as "a kind of continuous matter with some radius of curvature" [10]. The lateral resolution was therefore expected to be limited to something on the order of the tip radius, at that time approximately 100 nm for state of the art field emission

tips. Images of atoms were an unexpected gift, a consequence of the existence of minitips or other roughness on the tip surface, together with the strong distance dependence of tunneling, which causes the nearest minitip to dominate.

We should not let speculation about could-have-beens detract from the accomplishment that was. In the space of the two years from first funding to project termination, Young et al built a new kind of microscope which was non-contacting, non-damaging, capable of three dimensional imaging, and which compared favorably in its topographic resolution to the best instruments of the time. They demonstrated a new principle of operation, analogs of which are now making significant contributions to every area of microscopy. And they obtained the first I - V characteristic curves for metal-vacuum-metal tunneling.

In addition to the notice, already mentioned, in the 1986 Nobel citation, Russell Young received a Presidential Citation in 1986. In 1992 he received the Gaede-Langmuir Award from the American Vacuum Society “for his invention of the Topografiner, an instrument which led to the development of the scanning tunneling microscope.” Today, the topografiner resides at the Smithsonian Institution.

Prepared by J. S. Villarrubia, with assistance from R. D. Young, F. Scire, E. C. Teague, and J. W. Gadzuk.

Bibliography

- [1] R. Young, J. Ward, and F. Scire, The Topografiner: An Instrument for Measuring Surface Microtopography, *Rev. Sci. Instrum.* **43**, 999-1011 (1972).
- [2] G. Binnig, H. Rohrer, Ch. Gerber, and E. Weibel, 7×7 Reconstruction on Si(111) Resolved in Real Space, *Phys. Rev. Lett.* **50**, 120-123 (1983).
- [3] L. A. Bottomley, Scanning Probe Microscopy, *Anal. Chem.* **70**, 425R-475R (1998).
- [4] R. D. Young, Field Emission Ultramicrometer, *Rev. Sci. Instrum.* **37**, 275-278 (1966).
- [5] Press release, Royal Swedish Academy of Sciences, October 15, 1986 (Text in brackets not in original).
- [6] R. Young, J. Ward, and F. Scire, Observation of Metal-Vacuum-Metal Tunneling, Field Emission, and the Transition Region, *Phys. Rev. Lett.* **27**, 922-924 (1971).
- [7] R. D. Young, Theoretical Total-Energy Distribution of Field-Emitted Electrons, *Phys. Rev.* **113**, 110-114 (1959).
- [8] R. D. Young, Surface microtopography, *Phys. Today* **24** (11), 42-49 (1971).
- [9] R. D. Young, memorandum to Dr. John Simpson, July 19, 1971.
- [10] G. Binnig and H. Rohrer, Scanning Tunneling Microscopy—from Birth to Adolescence, *Rev. Mod. Phys.* **59**, 615-625 (1987).

Electron-Stimulated Desorption

It has now been almost 30 years since the 1971 review article entitled *Electron-Stimulated Desorption as a Tool for Studies of Chemisorption: A Review* [1] appeared. At that time, the authors, Theodore Madey and John Yates, were young scientists working together in the Surface Chemistry Section of the Physical Chemistry Division of NBS. Few could have predicted that the subject of this review would multiply and remultiply, until today the electron-stimulated desorption phenomenon and a number of related subjects form a cornerstone of chemistry and physics on surfaces—and that the personal collaboration forged at the time would last for 19 years at NBS, resulting in over 100 joint publications, as well as a deep and lasting friendship.

Surface chemistry is traditionally driven by the thermal excitation of adsorbed species. In areas such as heterogeneous catalysis, thin film deposition by chemical vapor deposition, and corrosion passivation, one often thinks only of thermally-driven surface processes. In the late 1960s, quantitative studies of the thermal desorption of molecules chemisorbed on single crystal surfaces were just beginning. Questions about molecular dissociation and atom recombination processes were being studied on well-defined single crystal surfaces for the first time, both by Yates and Madey at NBS and by other investigators. In this fundamental work simple molecules, such as H₂, CO, N₂, CH₄, and NO, were employed so as not to make the chemistry complex.

The study of desorption processes initiated by electronic excitation instead of thermal excitation represented a departure from conventional research activities at the time and provided a special personal fascination for the authors which has to the present remained strong. The desorption of adsorbed species by non-thermal processes (i.e., electronic activation) became a new focus of the work starting about 1965. As a consequence of their work, Madey and Yates were invited by P.A. Redhead (a pioneer in electron stimulated surface processes, and the editor of the *Journal of Vacuum Science and Technology*) to write a critical review of what was being done worldwide in the area of electron stimulated desorption, a surface phenomenon which had already received the acronym ESD.

It is interesting to note that the title of the review contains the word “Tool.” In 1971, many new surface measurement techniques were being devised in the surface physics community and were being transferred to some degree to the surface chemistry, engineering,

and materials science communities in the form of exciting and useful new tools for research. The workers at NBS were inclined to think of ESD as a new measurement method for the study of adsorption. The review uncovered more than 100 papers dealing with phenomena related to ESD, extending back to 1918. At the time of the writing of the review, the vast majority of the important papers had been written within the previous 10 years. The most influential work had been done independently by Menzel and Gomer [2, 3] and by Redhead [4] in 1964. The basic electronic excitation mechanism for ESD is now termed the MGR mechanism worldwide in honor of their central contribution.

The 1971 review summarized the experimental methods that had been employed to date for the study of ESD, the theoretical foundation for thinking about the electronic excitation on the surface, and the subsequent desorption process. The authors also included almost all of the particular chemical systems that had been studied by ESD at the time. Since positive ionic fragments are often liberated in ESD, the review contains a number of examples of the use of mass spectrometers and other devices as ion detectors. It also contains criticisms of certain mechanistic ideas which were in the literature, as well as a selection of experimental data that were regarded as being the most reliable (including much of the authors' own data).

In addition to electron-impact induced adsorbate-surface bond breaking (desorption), molecules on surfaces may be chemically converted to other species by electron impact, and the review article illustrated this by including one of the authors' own studies in which adsorbed N₂ molecules were converted to adsorbed N atoms on a tungsten surface, one of the first examples of this phenomenon.

The review was 30 pages long and contained 152 references. It was not possible in a review of that length to do justice to all of this information. In order to summarize the work in these papers, a table was devised to list the principal findings; this table was arranged chronologically and by the adsorbate/adsorbent system and the experimental method. Not surprisingly, work on tungsten and molybdenum surfaces dominated, since during much of the 10 years prior to the review, it was known that atomically clean surfaces of these elements could be prepared through high temperature heating in ultrahigh vacuum. Much of this work was done without the luxury of Auger spectrometers for surface analysis.

Since 1971, well over 1000 papers on ESD have been published. Both Yates and Madey have published additional review articles in the field [5-8], and in 1991 65 reviews of ESD existed in the literature [6]. The acronym ESD, while still employed, has been replaced somewhat by the more encompassing acronym DIET (Desorption Induced by Electronic Transitions). An international meeting on this topic is held every two and a half years; the eighth meeting, organized in 1999 at Rutgers University by Ted Madey, attracted 80 attendees. The acronym DIET includes electronic excitation by photons as well as electrons, and in recent years photodesorption has become a dominant area in which both authors are working at their separate universities.

The writing of the review article was carried out on two continents. John Yates was working in Britain at the time, and many mailings of manuscript and figures were done in both directions to meet deadlines. One of the critical mailings from Britain was lost (and never found) as a result of the use of the Armed Forces mailing system because of a mail strike in Britain. The authors were caught off guard after publishing the 1971 review, since they were soon notified that it had become a Science Citation Classic by Citation Indices. They later remarked to Paul Redhead, "If we had thought we were writing a Classic, we would have written it in Latin."

One of the most exciting developments emanating from this collaboration had to do with the discovery of the ESDIAD (electron stimulated desorption ion angular distribution) phenomenon in 1974. Here the positive ion desorption products were found to be ejected in sharp beams whose direction was closely related to the direction of the chemical bond being ruptured in the electronic excitation process [9]. Fig. 1 shows the early ESDIAD apparatus and the three authors of the first paper, as well as photographic images of the ion angular distributions obtained.

Both Yates and Madey have left NBS for the academic world, and many honors have come to them, leading to professional recognition not only for the collaborative work done at NBS, but also for more recent work done independently at the University of Pittsburgh and at Rutgers University. The early work at NBS was centrally important to their professional development and to many of the rich opportunities they experienced since leaving government service. Indeed, the period from 1963 to the 1980s was generally one of extraordinary freedom in research at NBS in the field of surface science. Other NBS staff members who were their colleagues or friends and who numbered among the founders of the field include E. W. Plummer, J. W. Gadzuk, R. D. Young, C. J. Powell, A. Melmed, R.

Klein, and M. D. Scheer. The research benefited from the support of the Administration at NBS during this time, both at the Director's level (A. Astin, L. Branscomb, R. Roberts, E. Ambler) and at intermediate levels (M. B. Wallenstein, J. D. Hoffman, J. McNesby, M. D. Scheer, and R. Klein). Without excellent scientific colleagues and visionary administrators, NBS would not be historically recognized for its important role in establishing, and continuously nurturing to this day, the exciting and technologically important field of surface science.

It is appropriate to complete this account by citing recent articles from each of the authors' laboratories which are connected conceptually to the ESD phenomenon. In the first example, a photochemical dissociation process, involving an oriented O₂ molecule chemisorbed with its O-O axis parallel to the step-edge sites of a Pt single crystal, is found to preferentially eject an O atom toward a neighboring CO molecule to produce CO₂ which then desorbs [10]. This selectivity measured for target CO molecules on the step sites compared to CO molecules located on the terrace sites is termed surface aligned photochemistry (SAP), and is schematically illustrated in Fig. 2. This is the first observation of SAP involving molecular alignment on a stepped single crystal template.

The second example addresses an issue that has long puzzled planetary astronomers: what is the origin of the copious atomic sodium vapor in the rarefied atmosphere of the planet Mercury, and of our Moon? An image of this effect is shown in Fig. 3. A detailed DIET study of a model system (sodium atoms and ions adsorbed on SiO₂ surfaces, simulating moonrocks) identified the likely scenario: when ultraviolet light from the sun strikes the lunar surface, it excites the surface electronically and causes desorption of sodium atoms [11]. Electrons in the solar wind can also cause ESD of sodium from the lunar surface, but the more plentiful solar photons are the main culprits.

In conclusion, ESD and other DIET processes today impact a host of scientific issues, including structure and dynamics of adsorbed molecules, quantum state-resolved desorption, dynamics of charge transfer, and surface photochemistry. DIET processes also provide insights into the science and technology of radiation damage, which affects quantitative surface analysis using electron and photon beams, partial pressure measurements, stability of x-ray optics, electron- and photon-beam lithography, and molecular synthesis in interstellar space. ESD and DIET continue to be scientifically exciting, growing fields!

Prepared by Ted Madey and John Yates.

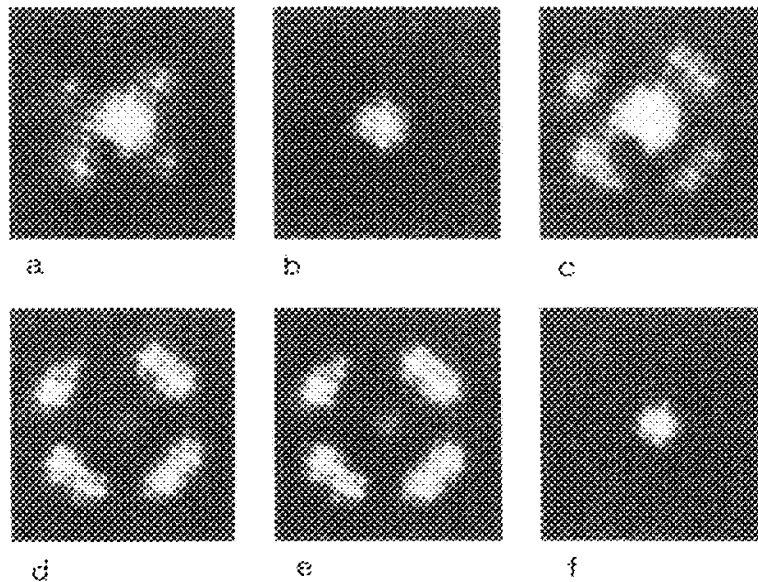
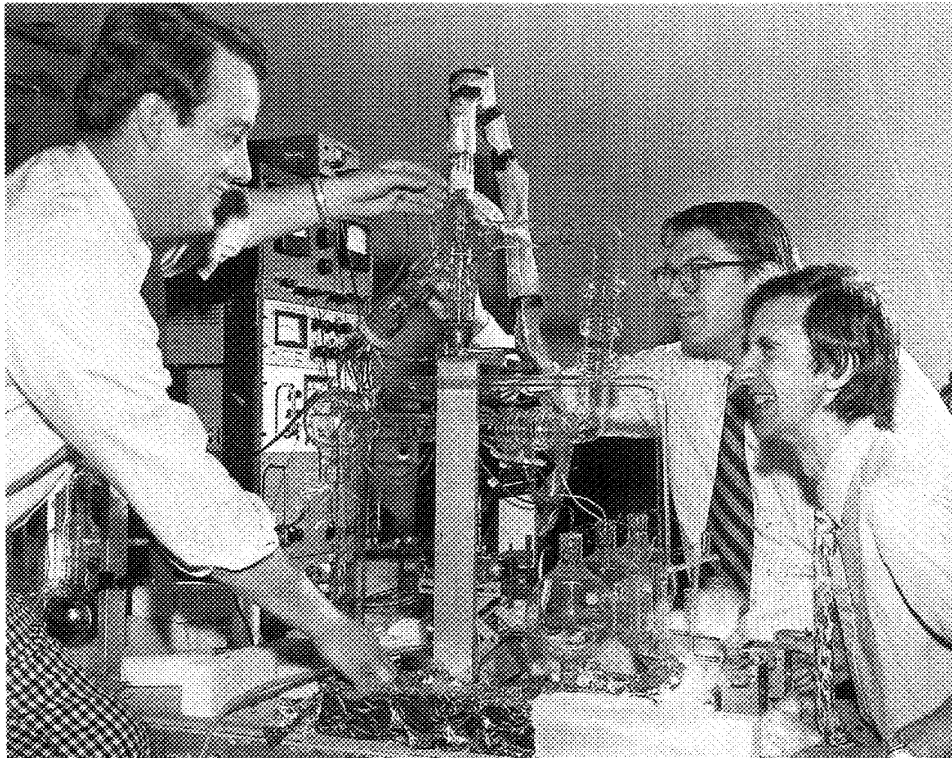

Fig. 1. (a) 1974 photograph of the first NBS ESDIAD system, a hybrid of glass and metal. From left to right, T. E. Madey, J. T. Yates, Jr., and J. J. Czyzewski. Madey's left hand is pointing to the ESDIAD tube; the ESDIAD patterns were photographed from below (from [9]).

(b) ESD Ion Angular Distribution (ESDIAD) patterns for desorption of oxygen ions (O^+) from W(100). This sequence shows the effect of heat treatment on ESD patterns for oxygen on W(100).

Temperatures corresponding to each pattern are (a) <400 , (b) 630, (c) 705, (d) 795, (e) 865 and (f) 930 K (from [9]).

Surface Aligned Photochemical Reaction

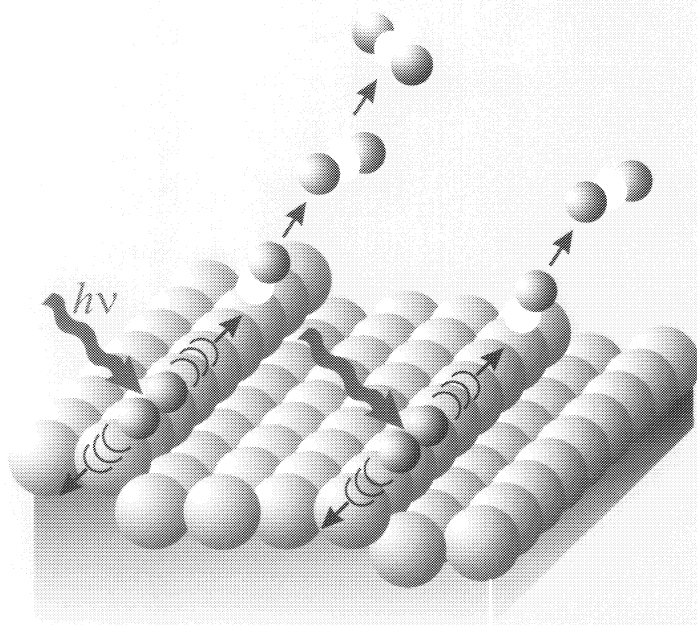

Fig. 2. Surface Aligned Photochemistry—The most probable reaction process is illustrated for the photoexcitation of adsorbed O₂ on a step site on a Pt single crystal and leading to reaction with step-bound CO molecules to produce CO₂ [10].

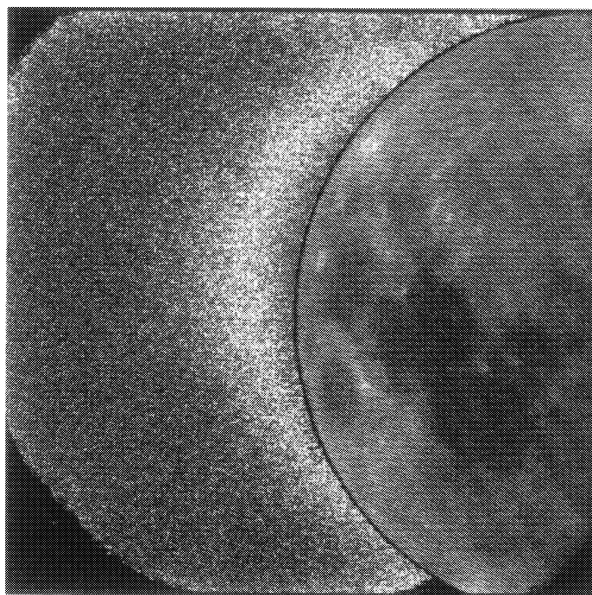

Fig. 3. Image of lunar sodium atmosphere due to DIET from the lunar surface [11,12].

Bibliography

- [1] Theodore E. Madey and John T. Yates, Jr., Electron-Stimulated Desorption as a Tool for Studies of Chemisorption: A Review, *J. Vac. Sci. Technol.* **8**, 525-555 (1971).
- [2] D. Menzel and R. Gomer, Desorption from Metal Surfaces by Low-Energy Electrons, *J. Chem. Phys.* **41**, 3311-3328 (1964).
- [3] D. Menzel and R. Gomer, Electron-Impact Desorption of Carbon Monoxide from Tungsten, *J. Chem. Phys.* **41**, 3329-3351 (1964).
- [4] P. A. Redhead, Interaction of Slow Electrons with Chemisorbed Oxygen, *Can. J. Phys.* **42**, 886-905 (1964).
- [5] T. E. Madey, Electron- and Photon-Stimulated Desorption: Probes of Structure and Bonding at Surfaces, *Science* **234**, 316-322 (1986).
- [6] R. D. Ramsier and J. T. Yates, Jr., Electron-Stimulated Desorption: Principles and Applications, *Surf. Sci. Rep.* **12**, 243-378 (1991).
- [7] J. T. Yates, Jr., J. Ahner and D. Mocuta, Tracking the Motion of Chemisorbed Molecules on Their Adsorption Sites, *Proc. Natl. Acad. Sci. U.S.A.* **95**, 443-449 (1998).
- [8] T. E. Madey, History of Desorption Induced by Electronic Transitions, *Surf. Sci.* **299/300**, 824-836 (1994).
- [9] J. J. Czyzewski, T. E. Madey, and J. T. Yates, Jr., Angular Distributions of Electron-Stimulated-Desorption Ions: Oxygen on W(100), *Phys. Rev. Lett.* **32**, 777-780 (1974).
- [10] C. Emil Tripa and J. T. Yates, Jr., Surface-Aligned Reaction of Photogenerated Oxygen Atoms with Carbon Monoxide Targets, *Nature* **398**, 591-593 (1999).
- [11] B. V. Yakshinskiy and T. E. Madey, Photon-stimulated Desorption as a Substantial Source of Sodium in the Lunar Atmosphere, *Nature* **400**, 642-644 (1999).
- [12] A. E. Potter and T. H. Morgan, Coronagraphic observations of the lunar sodium exosphere near the lunar surface, *J. Geophys. Res.—Planets* **103**, 8581-8586 (1998).

Photochemistry of Small Molecules

The classic text book in photochemistry is that of Noyes and Leighton, *The Photochemistry of Gases* published in 1941. In 1966, a comprehensive volume by Calvert and Pitts brought the field up to date, but it soon became obvious that the field of photochemistry was expanding too rapidly to be covered in a single comprehensive volume. In fact, in the latter part of the 20th century organic photochemistry and physical photochemistry existed as separate disciplines with largely separate constituencies. Organic photochemistry included such molecules as methane (CH_4), whereas NO and other oxides of nitrogen are inorganic. The book by Hideo Okabe, *Photochemistry of Small Molecules* [1], published in 1978, is so titled to convey the author's intent to include both organic and inorganic molecules, but to direct his attention to simple molecules of both genres. The author's definition of "small" as five or fewer atoms is arbitrary and, unfortunately, excludes much of his own seminal work on the photochemistry of ethane and propane, which contain eight and eleven atoms respectively.

In his *Photochemistry of Small Molecules* Okabe provides an elegant discussion of the spectroscopy of atoms and molecules as well as of the rotational, vibrational, and electronic energy states. In photochemical research, small molecules often have discrete electronic spectra, and any discussion of mechanisms of photochemical reactions must be consistent with these spectra. Accordingly, Okabe gives special attention to the details of what was known about the spectra. He systematically presents chapters on photochemistry and spectroscopy of diatomic, triatomic, and polyatomic molecules (i.e., four and five atom) in Chapters V, VI and VII of the book. His discussion of the basis of photochemical correlation rules and selection rules is very thoroughly presented. His knowledge of the relevant spectroscopy is at a very high level, and his incorporation of spectroscopic aspects into his discussion of the photochemistry, if not unique, is certainly extraordinary.

Okabe's subject, the photochemistry of small molecules, came into prominence in the 1960-1980 period just at the time when planetary modelers were struggling to provide a quantitative understanding of the chemistry of the atmospheres of the giant planets and their moons. The key molecules were methane and ammonia, and the electromagnetic radiation driving the chemistry was the Lyman alpha solar emission line in

the vacuum ultraviolet at 121.6 nm. It was Okabe and his NBS colleagues who provided much of the hard science in support of this objective. The table had been set for the writing of this scholarly book by the appearance in 1964 of a review of the field of vacuum ultraviolet (VUV) photochemistry by McNesby and Okabe [2]. The long term impact of Okabe's work is illustrated by Nobel Laureate Roald Hoffmann's devoting a chapter in his 1995 book [3] to Okabe's 1961 paper on the photolysis of ethane [4] ("a text book case for the application of the scientific method"). Another Nobel prize winner, Yuan T. Lee, published a paper in 1999 [5] with his colleagues in which testimony is given that Okabe was the discoverer of molecular elimination of hydrogen in VUV photolysis of hydrocarbons. The Lee paper was the first in which molecular elimination from propane was studied using very sophisticated techniques not even imagined at the time of Okabe's 1961 discovery. Lee and coworkers used 157 nm laser excitation of propane and employed photofragment translational spectroscopy to measure directly the site-specific molecular elimination of hydrogen. They determined that the elimination of molecular hydrogen from the central carbon atom was the dominant process. This is what Okabe concluded 37 years earlier on the basis of experiments with deuterated propanes [6,2].

As a result of the book and his series of research papers, Okabe became widely known as a leader in the field of vacuum ultraviolet photochemistry. There have been more than 600 (non-self) citations to *Photochemistry of Small Molecules*, and it continues to be regarded as the definitive text on this subject.

Prior to Okabe's work at NBS (which extended from 1959 to 1983), little attention was given to photochemical requirements for measurements in the vacuum ultraviolet, such as spectral purity of light sources, appropriate window materials, and the effect of temperature on the transmittance of these materials. When he first joined the photochemistry group at NBS, he was given the choice of a project to pursue, but was urged to consider photochemistry in the vacuum ultraviolet and soon made this commitment. He quickly recognized the necessity of establishing the purity and monochromaticity of his light sources. Early attempts to study VUV photochemistry with electroded resonance lamps were plagued by outgassed impurities which made it impossible to know the active wavelengths in the photolysis. Okabe's meticulous methods produced the first high

intensity rare gas resonance lamps with outputs of essentially pure wavelength. He achieved this by use of a scanning vacuum monochromator to establish the purity of the resonance lines of xenon, krypton, and argon, the first time this powerful technique was used by a photochemist. The simplicity of the design of the resonance lamps is illustrated in Fig. 1. By powering the light sources with a microwave generator and getting rid of the impurities, light sources of spectacular chromatic purity were produced (Fig. 2), which facilitated studies of the photolysis of small molecules in the vacuum ultraviolet.

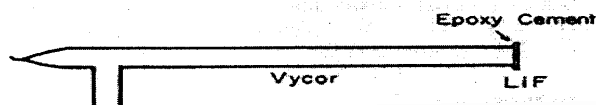

Fig. 1. Resonance lamp design.

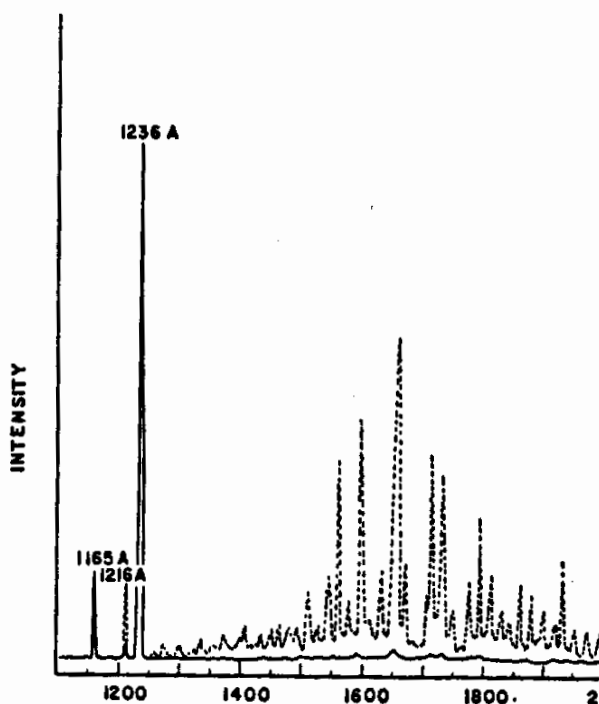

Fig. 2. Krypton resonance lamp with and without (----) getter.

There was particular interest in the NBS group in studying the kinetics of the reactions of methyl (CH_3) radicals. Virtually all such studies had been done by producing CH_3 by near ultraviolet photolysis of such large molecules as acetone. The difficulty always was the concurrent formation of large organic fragments accompanying the methyl radicals and the complications

attending the resulting chemistry. The simple solution to these problems seemed rather obvious—to photolyse ethane ($\text{CH}_3\text{-CH}_3$) since the conventional wisdom was that the weaker C-C bond would break, producing nothing but methyl radicals. What Okabe learned very quickly came as a tremendous surprise to him and to his colleagues. The conventional wisdom was wrong: the reaction product was almost entirely hydrogen rather than the expected methane. Further experiments with deuterium strategically placed at various locations in the molecule gave still more surprising results—that the molecular hydrogen produced came nearly exclusively by molecular elimination from one end of the molecule, not one hydrogen atom from each carbon atom.

This result was to change everyone's thinking about VUV photochemistry of ethane and other simple hydrocarbons of planetary interest, because the major planetary light source, Lyman alpha at 121.6 nm, had nearly the same frequency as the krypton resonance line at 123.6 nm. The extension of this research to methane photolysis, where H_2 was also found to be ejected, caused modelers of atmospheric dynamics of the giant planets, which are rich in methane, to alter their models. This result attracted the attention of NASA, which then partially supported the NBS work for a number of years, with the objective not only to understand planetary atmospheric dynamics but also to satisfy their well known interest in the origin of life in the solar system. In all cases the key molecules are water, methane, ammonia, and carbon dioxide (all "small molecules") and ethane.

Hideo Okabe was born 13 December 1923 in Nagano-ken, Japan. During World War II he was an undergraduate at the University of Tokyo; he was deferred from military service because he was a science student. Needless to say, these were trying times for him as bombs fell all around on a regular basis. As a student he was twice bombed out of his rooming house. After a protracted course of study during these ordeals, Okabe completed the requirements for an undergraduate degree in engineering in 1947. The idea of coming to the United States seemed attractive in a milieu that was driven by the devastation of Japan, resulting in its inability to support graduate education adequately. He had developed an interest in photochemistry during these years and ultimately applied for admission to the University of Rochester to work with the dean of academic photochemists, W. Albert Noyes, Jr. Hideo was awarded the Ph.D. from the University of Rochester in 1957, after which he received a post-doctoral appointment at the National Research Council of Canada with E. W. R. Steacie. Both Noyes and Steacie endorsed Okabe as one of their better students, and he was offered and accepted an NBS staff position in 1959. Shortly

after joining NBS he was granted a leave of absence to return to Japan for a short stay for the purpose of marrying his bride, Tomoko Shoji. The newlyweds returned to the United States and eventually he and Tomoko had three children. Okabe was a Visiting Scholar at Bonn University in 1963 and a Visiting Professor at Tokyo Institute of Technology in 1978, the year recognition came in the form of a Gold Medal from the U.S. Department of Commerce and the publication of *Photochemistry of Small Molecules* [1]. In 1983 Okabe's position at NBS was eliminated in a reorganization and he opted for early retirement, although he remained active at NBS as a consultant for a number of years. A colleague, then at Howard University in Washington but a former member of the NBS group, William M. Jackson, took him on as a senior researcher in his laboratory. Okabe still works at Howard as Research Professor of Chemistry in the Institute of Atmospheric Research and has two remaining graduate students.

Prepared by James R. McNesby with assistance from Ralph Klein.

Bibliography

- [1] Hideo Okabe, *Photochemistry of Small Molecules*, John Wiley & Sons, New York (1978).
- [2] J. R. McNesby and H. Okabe, Vacuum Ultraviolet Photochemistry, *Adv. Photochem.* **3**, 157-240 (1964).
- [3] R. Hoffmann, *The Same And Not The Same*, Columbia University Press, New York (1995).
- [4] H. Okabe and J. R. McNesby, Vacuum Ultraviolet Photolysis of Ethane: Molecular Detachment of Hydrogen, *J. Chem. Phys.* **34**, 668-669 (1961).
- [5] S. M. Wu, J. J. Lin, Y. T. Lee and X. Yang, Site Specificity in Molecular Hydrogen Elimination From Photodissociation of Propane at 157 nm, *J. Chem. Phys.* **111**, 1793-1796 (1999).
- [6] H. Okabe and J. R. McNesby, Vacuum Ultraviolet Photochemistry. IV. Photolysis of Propane, *J. Chem. Phys.* **37**, 1340-1346 (1962).

Role of Standard Reference Materials in Measurement Systems

In 1906 the National Bureau of Standards started to issue samples of materials for standardizing analytical techniques and methods. Today, the NIST inventory of standard samples, which are issued under a NIST-registered trademark, SRM®, consists of over 230,000 units of more than 1300 different products. Each year nearly 34,000 units are sold to over 7000 customers, 30 % of whom are foreign. Each of the 1300 current SRMs is the result of collaboration between NIST and representatives of science and industry; thus SRMs serve as crucial reference points in establishing a comprehensive measurement system for the United States.

NBS Monograph 148, *The Role of Standard Reference Materials in Measurement Systems* [1], provides SRM users with a systems approach to meaningful measurements through which SRMs can be used to produce measurement results that are precise and whose systematic errors are either eliminated or well understood. Monograph 148 presents five major components of this approach; their relationships are depicted in Fig. 1.

The authors of Monograph 148 recognized the need to articulate the role of SRMs in the U.S. measurement system, to explain how SRMs are certified, and to clarify what a NIST certification means in both a legal and technical sense. For many years this document has assisted the growing number of SRM users in the proper use of SRMs, especially in countries that were in the process of developing a national measurement system of their own based on reference materials and reference methodology. Although reference materials represent only one aspect of the total measurement system, NIST SRMs have always been a key mechanism for transferring NIST science and technology through channels of industry and commerce.

Monograph 148 describes the important role that NIST SRMs play in the U.S. measurement system, in terms of both general and specific uses across a broad spectrum of analytical disciplines and areas of impact. In today's technologically advanced world, standardization is essential as measurements are applied to an ever-growing list of properties and materials. The eight authors of this monograph brought years of experience and knowledge from eight different measurement disciplines, including statistics, to the composition of the document. Such diversity has made the monograph

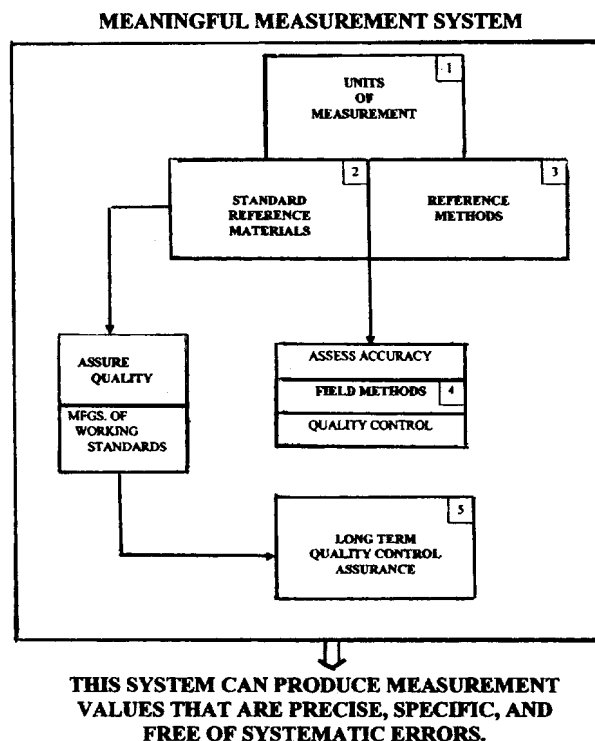

Fig. 1. Systems approach to the use of Standard Reference Materials in ensuring reliable measurements.

a classic reference among practitioners in the field of measurement systems.

The Role of Standard Reference Materials in Measurement Systems is divided into four sections plus appendices. The first section introduces the reader to the fundamentals of measurement and outlines a systematic approach to the process of obtaining measurements that are meaningful. Understanding such concepts allows one to understand the role that SRMs can play in a measurement system. While the introductory chapter provides the rationale for using SRMs, the second section discusses general concepts of usage, including the pitfalls that the user faces and their impact on measurement results. The third section provides users, especially new users, with a clear description of the SRM as a tool by which measurement methods, instruments, and systems can be validated or calibrated. The user is told how the pertinent information is condensed

into a certificate which provides qualitative statements and quantitative values, using data generated from tests and state-of-the-art measurements performed at NBS or a cooperating institution. The authors succinctly guide the users through the critical aspects of the SRM measurement and certification process. Realizing that the requirements for SRMs will become more exacting and complex in the future, the authors describe in section four the impact on standardization activities in five selected industries. Even today, those industries (metal, polymer, inorganic, clinical, nuclear) constitute areas where measurement needs are still in high demand or where requests for new types of reference materials have grown to unprecedented proportions.

The authors of NBS Monograph 148 provided the first documented account of a measurement system that would ensure meaningful measurements using standard Reference Materials as an integral part of the national measurement infrastructure. Monograph 148 continues to be used by practitioners and reference materials users, both nationally and internationally.

The authors represented a wide range of technical expertise. The principal author, J. Paul Cali, was Chief of the Office of Standard Reference Materials at NBS from 1966 to 1978, with responsibility to manage the production and certification of SRMs. Cali was an analytical chemist and an international authority on certification of reference materials, especially those used in environmental protection and clinical chemistry. The kinds of materials certified under Cali's direction included steel, non-ferrous alloys, Portland cement, glass, plastics, environmental, and clinical types. In a time when accuracy in measurement was becoming critical to quality assurance efforts, these SRMs had a decided impact in tens of thousands of laboratories on every continent.

In 1976, Cali received the DOC Exceptional Service Award (Gold Medal) for "highly effective leadership of the NBS Standard Reference Materials Program and improving clinical measurement standardization throughout the world." In the same year he was the recipient of the Edward Bennett Rosa Award, NBS/NIST's highest award for contributions to measurement advances.

Thomas W. Mears, an organic chemist, joined the Office of Standard Reference Materials in 1968 and coordinated the development of reference materials for high-octane gasoline, jet fuels, dielectric materials, and other hydrocarbon fuels. He was awarded the Department of Commerce Silver Medal for Meritorious Service for his research in synthesis, purification, and analyses during his career at NBS and for the development of a number of superior Standard Reference Materials and analytical methods.

Robert E. Michaelis joined NBS as a physicist in charge of spectrographic standard samples in 1952, after previous service as an engineering officer with the U.S. Air Force from 1942 to 1946 and as a technologist in charge of spectrochemical analysis in the U.S. Steel Research & Development Laboratory from 1947 to 1952. Beginning in 1963, he was assigned the major responsibility for the planning, preparation, testing and characterization for all metal Standard Reference Materials, certified either as to their chemical composition or their physical properties. Michaelis received many awards and honors, including the Meritorious Service Award (Silver Medal) from the Department of Commerce in 1963.

William P. Reed was supervisor of the Analytical Quality Control Laboratory at Hercules Powder Company before joining NBS in 1963 as a research chemist working in the field of Neutron Activation Analysis. In 1967, he was reassigned to the Office of Standard Reference Materials, where he coordinated reference materials activities in the nuclear and environmental fields. He also served two years as Chief of the Office of Standard Reference Materials. He was instrumental in establishing and maintaining cooperative programs between NBS and a number of foreign laboratories and organizations, including the International Atomic Energy Agency and the Geel Laboratory of the European Economic Community.

Richard W. Seward received a B.S. degree in engineering from the U.S. Military Academy in 1957 and joined NBS in 1963 as a technical editor/writer; he served as Managing Editor of the NBS Technical News Bulletin from 1965 to 1970. He was Technical Representative for Standard Reference Materials from 1970 to 1984 and Project Manager from 1984 to 1989. In 1982 he was awarded the DOC Bronze Metal "for outstanding management of Standard Reference Materials marketing and customer service activities."

Connie L. Stanley joined the National Bureau of Standards in 1954, conducting research in electroplating in the Electrodeposition Section of the Chemistry Division. He later worked as an organic chemist in the Engine Fuels Section of the Heat Division, where he was involved with the preparation of pure hydrocarbons and the determination of their physical properties. He joined the Office of Standard Reference Materials in 1972 as an SRM Coordinator for environmental standards.

H. Thomas Yolken was engaged in corrosion research in the Metallurgy Division from 1960 until 1966 and later was Special Scientific Assistant to the Director, Institute for Materials Research, involved in technical program planning. He was Deputy Chief, Office of Standard Reference Materials from 1971 to 1975 and

also Manager of the NBS Measurements for Nuclear Safeguards program. He was the author of more than 20 journal articles dealing with corrosion of metals, optics, Standard Reference Materials, and nuclear safeguards.

Harry Ku was a leading NBS statistician, who joined the Statistical Engineering Laboratory in 1958. He was very active in statistical consulting with Bureau scientists, combining his engineering background with his graduate education in the field of statistics. Ku's varied experience in support of experiments included problems of sampling the design for collection and reduction of data and the proper statement of uncertainties. Technical areas in which his assistance

was important include nuclear and environmental standards, radioactive isotopes, and reference materials for biological use. He paid particular attention to the problem of minimization of technical effort necessary to achieve the accuracy required.

Prepared by Thomas E. Gills.

Bibliography

- [1] J. P. Cali, T. W. Mears, R. E. Michaelis, W. P. Reed, R. W. Seward, C. L. Stanley, H. T. Yolken, and H. H. Ku, *The Role of Standard Reference Materials in Measurement Systems*, NBS Monograph 148, National Bureau of Standards, Washington, DC (1975).

Metrology and Standardization to Assist Industrializing Economies

In 1971, representatives from 16 countries, from 16 international and national organizations, and from 5 industrial companies came to a conference center in Northern Virginia to meet with representatives from the Agency for International Development (AID) of the U.S. Department of State and the National Bureau of Standards. They came to discuss how NBS promotes productivity growth and innovation in the United States and how the economies of developing countries might benefit from collaboration with NBS [1]. As raw materials prices sagged worldwide, these countries looked to industrialization as a source of growth. But where would they turn for help in developing their basic infrastructure?

Such countries were generally well accustomed to international discussions such as are provided by the United Nations, and to government-to-government negotiations. They appreciated economic assistance from the U.S. AID. However, AID claimed no primary responsibility and only limited expertise in commercial technology. NBS, with its extensive links to private industry, was the agency best positioned to help these countries understand how the U.S. industrial development system works. To fulfill the dreams of industrializing economies (IEs), Glenn Schweitzer, head of AID's Office of Science and Technology, in cooperation with Edward L. Brady at NBS, developed the idea of co-sponsorship of this Seminar. The goal was to determine to what extent these IEs (this label became preferred over "Less Developed Country," or "LDC") could be given access to the knowledge and experience NBS had with measurement and documentary standards, as well as to constructive contacts with industry that were mutually beneficial. Industry is the primary source of expertise in technology in which IEs wanted to share and advance in a self-reliant way.

After experience in both research and diplomacy, Edward Brady had been brought to NBS in 1963 to establish the Standard Reference Data Program. Brady knew well that NBS had no clear Congressional mandate to assist IEs. Thus NBS, at this Seminar, wanted to listen to IEs needs and then to judge whether it was possible to devise projects that could tackle goals that were in the common interest of NBS and some IEs. The recommendations from the Seminar were strongly positive and very hopeful. The response by Lewis M. Branscomb, who had just been confirmed as NBS

Director, and two former NBS Directors, Allen V. Astin and Edward U. Condon (representing UNIDO the United Nations Industrial Development Organization), were realistically encouraging. To a few voices at NBS who doubted whether these activities related strongly to the NBS mission, Branscomb suggested that the NBS staff, by guiding IEs, could better understand its own relationships with industry, standards associations, and the public [1, p. 7].

The activities that were taken in response to the Seminar received a general evaluation after seven years [2]; it strongly favored continuation of the projects that had been started. During the remaining years of the 20th century, assistance to IEs grew rapidly and became a significant and flourishing operational feature of NBS and NIST, which now publishes biennially a volume summarizing the International Activities [3].

Generally, since 1971, NBS/NIST has been the only technical institution in the U.S. Government that IEs could look to for guidance on technology-based development strategies. . . . It is an unheralded but highly significant role with the result that NBS/NIST is much better known in foreign capitals than in our own.

Among the topics in which assistance was given, pride of place belongs to measurement standards and their use in measurement science (metrology). In the United States, NBS/NIST has a primary responsibility in this field, including ensuring international conformance under the Convention of the Meter, a treaty adopted by the United States and 42 other signatories. The International Bureau of Weights and Measures [4] operates under that Convention as the technical laboratory that enables national metrology laboratories to intercompare their national measurement standards. At the time of the Seminar [1], BIPM was engaged in the dynamic process of refining and introducing

the International System of Units (SI). NBS helped many IEs to follow and understand the mathematically beautiful, but really quite complex, recommendations of BIPM. NBS/NIST style calibrations link measurements in a chain of comparisons with BIPM standards. Through familiarity with the technical rigor of NBS metrology, the concept of self-evaluation with self-assurance of measurement quality spread to many IE laboratories.

However, the highest levels of metrological technology, required for international comparisons of measurement standards representing the base units, does little to ensure equity in the retail markets of IEs or to bring credibility to their international trade. Nevertheless, the possession of a platinum-iridium kilogram standard, or an interferometer that compares wavelengths of laser emissions directly with a national meter bar, received undue attention in many of the least developed countries. These problems were addressed during an NBS arranged seminar in Korea [5] with the title: "Metrology in Industry and Government: How to Find Out Who Needs What Services."

Another topic in which NBS/IE collaboration has been very strong is that of documentary standards for health, safety, the environment, products, buildings, etc. Most such standards are not published by NBS, but by the hundred or so important national and international standards-writing organizations. They often look to NBS to provide expertise, technical experimentation, and a reference collection. In the early 1970s, NBS technical staff members served as unbiased technical experts on some 1500 voluntary technical standards committees. A part of this work was devoted to dissemination of standards information, and a portion of that played in the international arena through many joint seminars such as those cosponsored with the International Organization for Standardization (ISO). The first of these had the title of "Technological Knowledge Base for Industrializing Countries" [6]. It had the dual purpose of helping to prepare the U.S. for the UN Conference on Science and Technology for Development (UNCSTD) in Vienna, with the benefit of constructive input from IE representatives who had experience of NBS assistance. Former NBS Director Lewis M. Branscomb was a member of the U.S. delegation to the UNDP conference in Vienna.

A special feature of the NBS/NIST influence, with which many IEs were initially uncomfortable, is the American preference, wherever possible, for voluntary instead of mandatory standards. Experience has shown that consensus is more easily achieved when voluntary standards are developed. Furthermore, they are then better understood and adhered to by industry and the

public. Tort law acts to compel compliance with well established voluntary, as well as mandatory, standards.

The Standard Reference Materials program has been another topic for strong collaboration [1, p. 95-105]. Standard Reference Materials (SRMs) bring great benefits to industries. Measurements on materials are needed for raw material selection, process control, and quality assurance. By virtue of SRMs, good measurements are no longer simply the prerogative of the highly industrialized nations with primary metrological laboratories. High-quality measurements can now be made locally in IEs just as they are made in manufacturing centers of highly industrialized countries. One or more of the material properties of SRMs are determined by NBS/NIST with high, generally certified, accuracy. SRMs can then be used for calibration of measuring equipment or direct comparison with closely similar local materials. NBS is the world leader in the supply of reference materials. The optimization of selected SRM candidates, their manufacture, and their introduction are demanding. Assistance from physicists and chemists from IEs who help to certify and use these materials continues to be significant.

Essential to industry is also the availability of evaluated data, especially on material properties. Through the National Standard Reference Data System, NSRDS, Congress gave NBS a leadership role. To evaluate such data from the primary literature and make them available in a user friendly mode is a task for which NBS has received help not only from scientists throughout the United States and other industrialized countries, but from IE specialists as well. China, for instance, has taken a significant part, first on a bilateral basis with NIST and, more recently, through membership in CODATA, under the International Council of Scientific Unions, in which Lewis Branscomb, David Lide, and John Rumble of NBS/NIST have successively taken leadership positions.

To understand how yet another aspect of IEs' collaboration has benefited both NBS and the IEs, we should turn back in the history to former NBS Director G. K. Burgess [7], who instituted the innovative Guest Worker Program almost 75 years ago. After the Seminar [1], L. M. Branscomb permitted the Guest Worker Program to be extended to include staff members of counterpart IE institutions, provided their stay at NBS/NIST was at least six months and provided they worked on NBS' own projects and, initially, provided the cost was not borne by NBS. After their return home, these visitors often introduced projects in their own institutions that were similar to their assigned NBS studies. Both NBS and the IE institutions benefited from this more efficient

use of scarce scientific talent. In the ten years following the Seminar, guest scientists came to NBS from 43 countries. Since then that program has expanded. Today, about one fifth of the NIST technical staff are guest workers, many of them from IE countries, sharing the commitment to accuracy, reliability, and quiet confidence in service to the United States and to their home institutions.

Even before the Seminar [1], in 1967, President Lyndon Johnson, on a visit to Korea and Taiwan, called for NBS to send an advisory team on measurement and standardization. A small team under Forest K. Harris responded by brief visits to both countries. On consideration of the reports by the team, AID wondered whether similar studies, that is surveys of standardization and measurement services, were potentially helpful to a wide range of IEs, while also in the interests of NBS and the United States. That possibility came up again during the Seminar [1] and found a strong affirmative response. Eventually, 10 countries were so “surveyed” (one per year until 1980) with respect to their individual standardization and measurement service needs. In sequential order, these countries were: Korea, Ecuador, Turkey, Bolivia, The Philippines, Thailand, Guyana, Indonesia, Pakistan, and The Sudan. The survey events followed a general pattern set at NBS’ request: The government of the target country requested the survey and committed itself to all in-country expenses for the NBS team and its own counterpart team. The target-country team leader also became committed to be available, on request by NBS, for one or more similar future surveys of other countries in a different part of the world. An NBS team member then visited the country to meet with the counterpart team leader. Jointly they identified the most important needs and outlined a team itinerary. The NBS team leader identified the most suitable team members from NBS or other agencies and representatives from other target countries. The entire multi-country team assembled at NBS for a week’s workshop to examine critically and debate NBS measurement and standardization services, with emphasis on voluntary standards, calibration programs, certified reference materials, standard reference data management, and NBS relations in support of industry. The team was then ready to spend two weeks in the country with a full program of visits and discussions. With target country approval, a detailed final report was issued on the results achieved. In subsequent years, evaluation and follow-up programs were commonly requested and executed. Literature references exist for the 10 survey reports, the respective preliminary workshops, and any follow-up seminars.

It was a special feature of the original Seminar [1] that, at the invitation of the Scientific Apparatus Makers Association, the delegates from abroad were given the opportunity to remain at NBS for an additional week when the IE visitors could observe NBS operations and visit a number of scientific instrument manufacturers. These workshops have been so well appreciated by AID and the IEs themselves that they have become with little change, but with suitably updated content, a regular, continuing feature at NIST.

Whereas most of the above projects are essentially bilateral, a significant portion of continuing AID/NBS assistance to IEs is aimed at multilateral collaboration. An early example is the Seminar in Bolivia on “A System of Standardization and Metrology for Latin America” with advisors from Turkey, Thailand, and Korea. [8]. From this modest beginning the Interamerican Metrology System (SIM) evolved with 34 member countries. It celebrated its 20th anniversary in 1999. A regional seminar that focused on a more specific problem was that in Singapore on “Testing and Certification for Export Products in Industrializing Countries” [9]. South-East Asia is another region which has since instituted strong contact with NIST. Being unable to maintain active bilateral relations with the many countries of Africa, NIST has started regional mechanisms in South Africa, Kenya, Ghana, and Egypt.

NBS collaboration in the Middle East has a long history that precedes the original Seminar [1] to the time when the Congressional PL 480 Program was established. It freed certain non-convertible local currency assets for use in science research of interest to U.S. federal agencies. During the 1970s, NBS received such funds in Israel, Yugoslavia, India, Pakistan, Egypt, and Tunisia [10]. This NBS program had 67 research projects and was particularly successful in Israel, where it led to a continuing binational agreement for industrial research cooperation. After about 1979, most of the remaining PL 480 projects naturally melted into the regional IE cooperations. With India, for example, projects are continued under the U.S.-India Forum in Science and Technology and received strong support from an initially independent effort by Peter Heydemann of NBS/NIST.

Heydemann had been a member of the NBS/AID team survey of Pakistan’s standardization and measurement services (see above). Subsequently he arranged seminars and training courses in Pakistan and India. His many contacts in India prompted the Department of State to appoint him as Science Counselor at the U.S. Embassy in India (1988-1993), resulting in expanded collaborations between U.S. and Indian

technical organizations. At the same time, Heydemann had the opportunity to collaborate with U.S. companies trading with India, with a focus on standards and measurement problems. After Heydemann's return to NIST as Director of Technology Services, he established a Standards in Trade Program to assist U.S. companies to overcome technical barriers in foreign countries. From this program's initial activities in Saudi Arabia, it expanded to countries in the Middle East, Europe, and Latin America. Five NIST standards experts placed in foreign markets, together with the staff of the Global Standards Program in the Office of Standards Services, have been credited with adding almost one billion dollars per year in U.S. exports. Very recently, the Secretary of Commerce confirmed the policy of NIST's support for international trade by making a special award to the NBS Director for International and Academic Affairs, B. Stephen Carpenter, "... an ambassador of goodwill for U.S. measurement capabilities all around the globe."

Among other projects that NBS carried out with AID support was a successful 3-year interlaboratory collaboration across national boundaries with Instituto de Pesquisas Tecnológicas of São Paulo, Brazil. Although relevant notes exist, this NBS/IPT program is not well documented, partly because Brady hoped after retirement to write a small book on that experience. The time was no longer given to him.

Generally, since 1971, NBS/NIST has been the only technical institution in the U.S. government that IEs could look to for guidance on technology-based development strategies. Not only the directors, but virtually all senior staff members of NBS/NIST have actively participated in these IE projects. It is an unheralded but highly significant role with the result that NBS/NIST is much better known in foreign capitals than in our own.

Edward L. Brady (1919-1987) received a BA and an MA from the University of California at Los Angeles and a Ph.D. at the Massachusetts Institute of Technology, under the guidance of Martin Deutsch. His thesis on angular correlations between successive nuclear gamma rays is still regarded as an important contribution. In 1942 he joined the Manhattan Project at the University of Chicago. Later he was assigned to the Clinton Laboratories in Oak Ridge and the GE Knolls Atomic Power Laboratory in Schenectady. Brady enjoyed work in international relations, where, in addition to his scientific knowledge and experience, his human qualities and tact made him outstanding. He

served as U.S. Atomic Energy Commission Representative to the United Kingdom and as Advisor to the U.S. Mission to the International Atomic Energy Agency in Vienna. He came to NBS in 1963 as the first Director of the Standard Reference Data program and later became NBS Associate Director for Information Programs. Brady was a man of compassion, dignity, culture, and grace. His life's early end occurred after a struggle with cancer which his wife, Evelyn, associated with exposures to radiation during his work on atomic-energy projects.

Prepared by Lewis M. Branscomb.

References

- [1] H. L. Mason and H. S. Peiser (eds., with Foreword by L. M. Branscomb), *Metrology and Standardization in Less-Developed Countries: The Role of a National Capability for Industrializing Economies*, Proceedings of a Seminar Held at Airlie House, Warrenton, VA, February 1-4, 1971; NBS Special Publication 359, National Bureau of Standards, Washington, DC (1971).
- [2] H. Steffen Peiser and John A. Birch (eds.), *Standardization in Support of Development*, NBS Special Publication 507, National Bureau of Standards, Washington, DC (1978).
- [3] Marian F. McCurley (ed.), *NIST International and Academic Activities for FY 1997/1998*, NIST Special Publication 940, National Institute of Standards and Technology, Gaithersburg, MD (1999).
- [4] Chester H. Page and Paul Vigoureux (eds.), *The International Bureau of Weights and Measures, 1875-1975: Translation of the BIPM Centennial Volume*, NBS Special Publication 420, National Bureau of Standards, Washington, DC (1975).
- [5] H. Steffen Peiser, Raymond C. Sangster, and Wun Jung, *Metrology in Industry and Government: How to Find out Who Needs What Services*, Proceedings of a Regional Seminar held at the Korea Standards Research Institute, Dae Jeon, Korea, 1978, NBS Special Publication 539, National Bureau of Standards, Washington, DC (1979).
- [6] Raymond C. Sangster (ed.), *The Technological Knowledge Base for Industrializing Countries*, NBS Special Publication 543, National Bureau of Standards, Washington, DC (1979).
- [7] G. K. Burgess, *Research Associates at the Bureau of Standards*, NBS Circular 296, National Bureau of Standards, Washington, DC (1925).
- [8] H. Steffen Peiser and Robert S. Marvin (eds.), *Regional Seminar on a System of Standardization and Metrology for Latin America*, NBS Interagency Report 76-988, National Bureau of Standards, Washington, DC (1976).
- [9] H. Steffen Peiser and Robert S. Marvin, *Testing and Certification for Export Products in Industrializing Countries*, NBS Special Publication 438, National Bureau of Standards, Washington, DC (1976).
- [10] H. S. Peiser, *Recalling the PL-480 Program at NBS*, NBS/NIST SAA Newsletter, 13-14 December, 1998.

Publications Taking Us Toward a Metric America

For almost its entire existence, NBS/NIST has been interested and directly involved in America's bumpy and prolonged transition to the metric system of measurement. This involvement has had and continues to have many facets. On the technical front, NIST works with scientists from around the world to achieve continually improving precision in metric system measurements and unit definitions, and NIST policy specifies metric units in all staff reports. On a public policy front, the Bureau has for many years striven to increase the American public's understanding and acceptance of metric measurement units.

One prime example of an informative and easily read metric publication which effectively reaches out to a non-traditional NBS/NIST audience is the *Metric Style Guide for the News Media* [1]. Originally published in 1976 with revisions and updates in 1992 and 1997, the publication serves as a compact and accurate "metric literacy" reference document, giving the reader an overview of the units and the grammar of the metric system. Size approximations are provided to help readers visualize common metric units, and easy-to-use tables of common metric prefixes and conversions are also included. The *Style Guide* makes the point that Americans will compete more successfully in the global marketplace when they understand and speak the international language of measurement.

The news media have an important role in assisting the American public as we make the transition to the international language of measurement. Correct and positive use of metric terms and symbols by the media helps to smooth this transition. For almost 25 years, the *Style Guide* has continued to be extremely popular, not only with the news media, but also with school teachers and the general public. Teachers, especially, have praised the pamphlet for its ability to aid in the teaching of metric literacy. Approximately 200,000 copies of the *Style Guide* have been printed and distributed.

Two other NBS/NIST publications, *The Chart of the Modern Metric System* [2] and *A Brief History of Measurement Systems with a Chart of the Modern Metric System* [3], also serve as important tools in the effort to promote metric literacy. These publications are especially notable for their long-lived popularity and widespread dissemination. The first of these [2] is a full-color wall chart (ISO A1-sized poster) which highlights, graphically illustrates, and explains the seven

base units of the SI metric system. The chart's usefulness in helping students learn and understand the metric system is enhanced by the inclusion of three well-designed and easy-to-use tables: metric system prefixes, common conversions, and SI names and symbols for units that are derived from the base units.

A sister publication to the large wall chart is the equally-popular 1/4-sized (ISO A3 size) small wall chart [3]. On the reverse side of the small wall chart, a well-written article explains the importance of weights and measures to all societies and traces the history and development of both the English and the metric systems of measurement.

After more than three decades of life, the two charts and the measurement history article remain among the Metric Program's most requested items. Several hundred thousand of these colorful and informative wall charts have been produced, and they can be found hanging everywhere from elementary school classrooms to the offices of physicists. Originally designed and printed in 1968, both of the charts have been revised and reprinted several times, with major changes made in 1986 and 1997.

The Bureau's involvement in the national debate over metrication reached a critical pitch in the late 1960s. In a project that would later be described by Lewis Branscomb as the biggest NBS project of his directorship, the Bureau embarked on the U.S. Metric Study. In the Metric Study Act of 1968 (P.L. 90-472), Congress directed the Secretary of Commerce to conduct an extensive study to determine the advantages and disadvantages of increased metric use in the United States and to submit a full report to Congress within three years. The Secretary of Commerce delegated responsibility for the study to NBS.

The Metric Study Group was directed by Daniel De Simone with a team of over 40 NBS program managers and supporting staff. Also heavily involved in the study were 50 private-sector members of a Metric System Study Advisory Panel. The panel members were appointed by the Secretary of Commerce from organizations representing a wide spectrum of interests. The chairman of the panel was Louis Polk, a director of the Bendix Corporation.

Following a detailed blueprint, the study sought facts and opinions from over 700 major groups representing every sector of society—including labor unions, trade

associations, professional societies, education associations, consumer-related organizations, and many others. Input was obtained through a series of multi-day public hearings, surveys, correspondence, and other supplementary investigations.

The report to Congress was published as a 190-page NBS Special Publication entitled *A Metric America: A Decision Whose Time Has Come* [4]. Intended for wide distribution, this landmark publication details the

findings and conclusions of the U.S. Metric Study. The report includes several specific recommendations for the Nation to achieve a smooth and coordinated transition to the metric system of measurement. Many of these recommendations were summarized in the report's transmittal letter to Congress which was signed by Secretary of Commerce Maurice H. Stans. This letter is reproduced as Fig. 1.

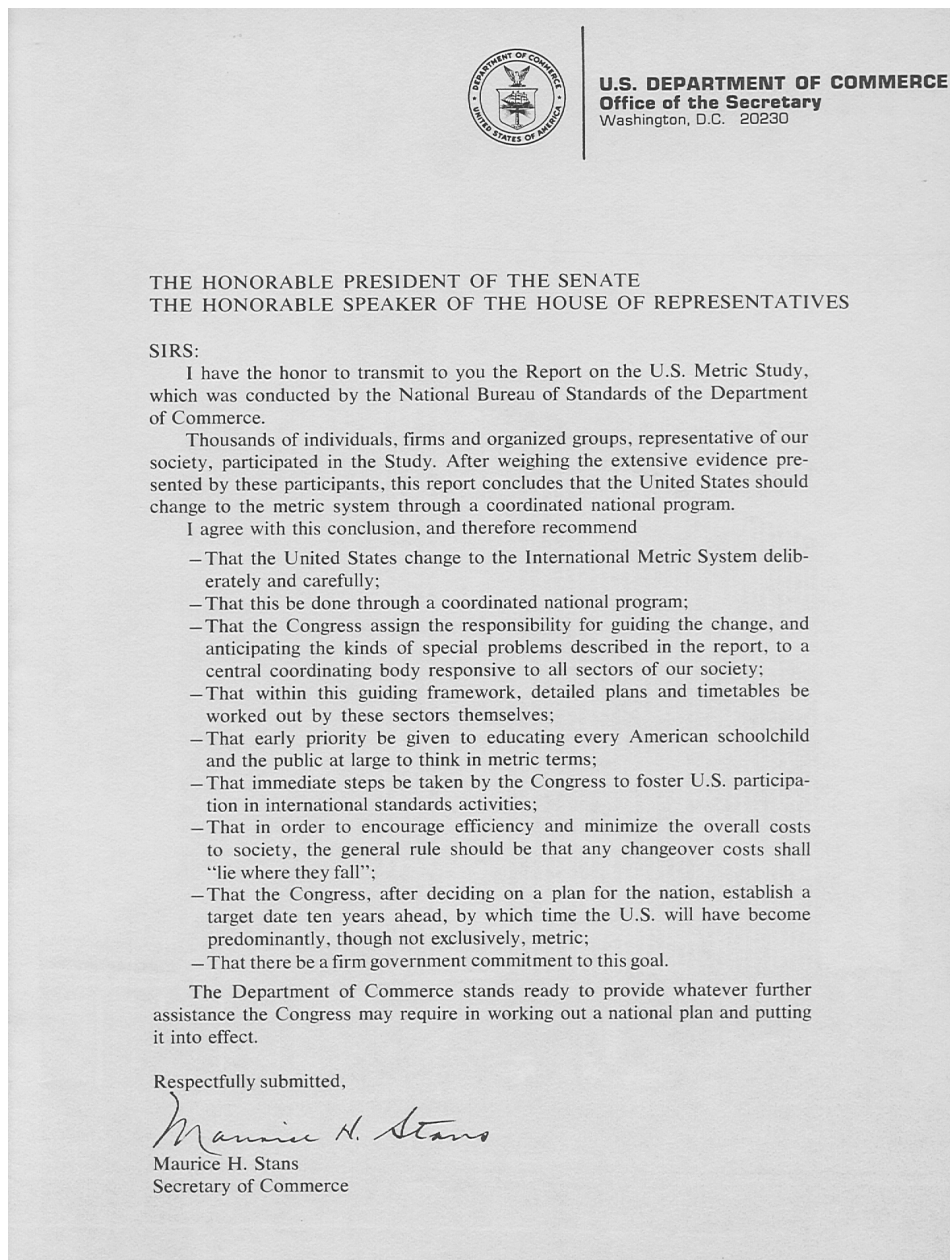

Fig. 1. Letter from the Secretary of Commerce to Congress transmitting the NBS Report on the U.S. Metric Study.

In addition to the main summary report, 12 supporting volumes were produced as part of the project—for a grand total of over 2300 pages of published text. These supporting volumes were entitled:

International Standards (NBS SP 345-1)
Federal Government: Civilian Agencies (345-2)
Commercial Weights and Measures (345-3)
The Manufacturing Industry (345-4)
Nonmanufacturing Business (345-5)
Education (345-6)
The Consumer (345-7)
International Trade (345-8)
Department of Defense (345-9)
A History of the Metric System Controversy in the United States (345-10)
Engineering Standards (345-11)
Testimony of Nationally Representative Groups (345-12).

Because of its importance as the summary document of the most significant study on national metrication issues ever conducted by the United States government, the *Metric America* publication has been (and continues to be) cited as a reference in hundreds of books, magazines, and newspaper articles—the current edition of *Encyclopedia Britannica* being one example.

The report was cited heavily when the 92nd and the 93rd Congresses debated legislative proposals and national conversion issues. Finally, four years after the report was first published, the Metric Conversion Act was passed by the 94th Congress in 1975 and signed into law by President Ford. The Act was an important milestone, yet disappointing to many of the U.S. Metric Study contributors because several of the report's

recommendations—such as the importance of a carefully planned transition, target dates, and a coordinated national program—were not implemented in the final language of the legislation.

In 1988, amendments to the Metric Conversion Act, Congress gave a significant boost to the metric effort by declaring the metric system to be the preferred system of measurement for U.S. trade and commerce. Unfortunately, even today, many of the issues and debates surrounding national metrication still linger.

As America enters the new millennium and NBS/NIST enters its second century, there is an increased desire by Americans to work, communicate, and live as part of the larger, global community—and the metric system is the global community's language of measurement. Increased public understanding and acceptance of metric measures is an on-going effort which NIST continues to support through several excellent publications and many other outreach activities.

Prepared by Ralph A. Richter.

Bibliography

- [1] *Metric Style Guide for the News Media*, NBS Letter Circular 1137, National Bureau of Standards, Washington, DC, December 1976.
- [2] *Chart of the Modernized Metric System*, NBS Special Publication 304, National Bureau of Standards, Washington, DC (1968).
- [3] *Brief History and Use of the English and Metric Systems of Measurement with a Chart of the Modernized Metric System*, NBS Special Publication 304A, National Bureau of Standards, Washington, DC (1968).
- [4] *A Metric America: A Decision Whose Time Has Come*, NBS Special Publication 345, National Bureau of Standards, Washington, DC, July 1971.

A New Approach to Manipulator Control: The Cerebellar Model Articulation Controller

The Cerebellar Model Articulation Controller (CMAC) [1, 2] is a neural network that models the structure and function of the part of the brain known as the cerebellum. The cerebellum provides precise coordination of motor control for such body parts as the eyes, arms, fingers, legs, and wings. It stores and retrieves information required to control thousands of muscles in producing coordinated behavior as a function of time. CMAC was designed to provide this kind of motor control for robotic manipulators. CMAC is a kind of memory, or table look-up mechanism, that is capable of learning motor behavior. It exhibits properties such as generalization, learning interference, discrimination, and forgetting that are characteristic of motor learning in biological creatures.

In a biological motor system, the drive signal for each muscle is a function of many variables. These include feedback from sensors that measure position, velocity, and acceleration of the limb; stretch in muscles; tension

in tendons; and tactile sensations from various points on the skin. Feedback also includes information from the eyes via the superior colliculus and visual cortex about the positions of the hands and feet relative to their intended targets. Drive signals to the muscles also depend on higher level ideas, plans, intentions, motives, and urges. These may be specified by variables that identify the name of the task to be performed and specify the goals that are desired, the procedures and knowledge required to achieve those goals, and the priorities that have been assigned to achieving those goals.

A block diagram of a typical CMAC is shown in Fig. 1. CMAC modules are designed to accept both input command variables from higher levels and feedback variables from sensors. Each CMAC merges these two inputs into a set of memory addresses wherein are stored the correct motor response. The combined input selects a set of memory locations from a large pool of memory locations. The output is the sum of the contents

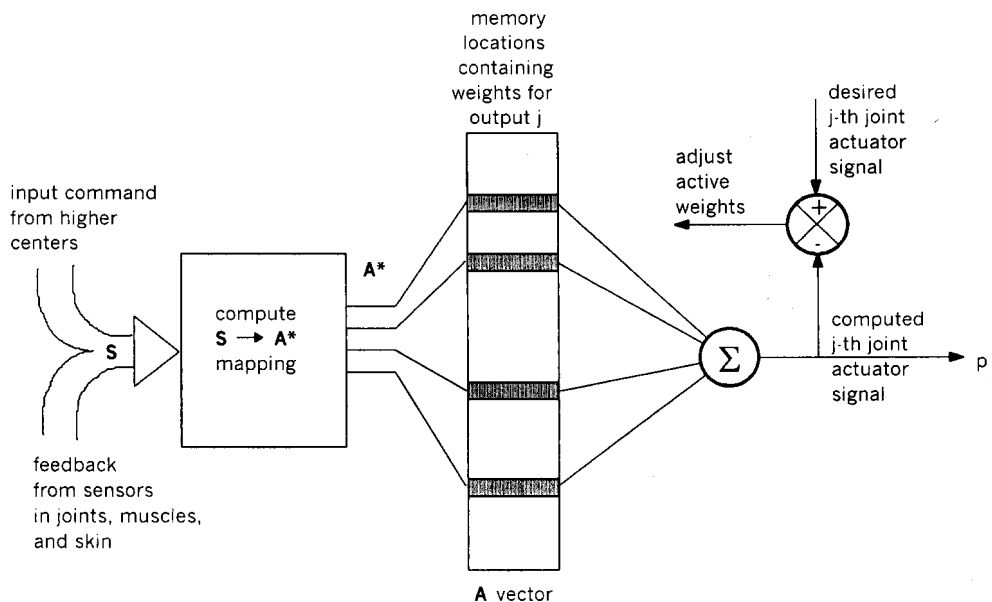

Fig. 1. A block diagram of a CMAC for a single joint actuator. The vector S consists of an input command from higher motor centers combined with feedback from sensors in the joints, muscles, and skin of a limb. Each CMAC separately computes a $S \Rightarrow A^*$ mapping. A^* is the set of locations in memory selected by the mapping. The selected locations in A^* contain weights corresponding to synaptic strength between parallel fibers and dendrites on a cerebellar Purkinje cell. The computed output is the sum of the weights stored in the A^* address set. In this example, the output is a drive signal p_j to the j -th joint actuator controller. The output signal may define a desired position, velocity, or force of the j -th joint actuator depending on the command.

of the selected memory locations. Feedback input from sensors causes the behavior to evolve along a goal-directed stimulus-response chain. As feedback changes, the output changes. This, in turn, causes the sensory feedback to change further. The result is a closed servo loop that makes the behavior reactive. The input command from above effectively selects a region of memory wherein the proper set of stimulus-response pairs to generate the desired behavior can be stored.

For each command, a string of stimuli produces a string of responses. For a different command, the same stimuli may produce a different string of responses. The result is that a CMAC module decomposes each different input command into a different string of subcommands. Each different string of subcommands corresponds to a different behavior. Thus, whenever the command changes, a different behavior is generated. For example, a command such as <pick up object X> will select a region of memory where motor behavior appropriate for picking up an object is stored. A different command such as <scratch itch at skin location Y> will select a different region of memory where scratching behavior is stored.

CMAC learns correct output responses for various input conditions by modifying the contents of the selected memory locations. For each input, the learning process computes the difference between the CMAC output and the desired output (provided by a teacher) as shown in Fig. 1. This difference determines a correction factor that is added to the contents of each of the selected memory locations. The rate of learning depends on a gain factor that determines the magnitude of the correction factor.

The $\mathbf{S} \Rightarrow \mathbf{A}^*$ mapping employed by CMAC has the property that any two input vectors that are similar (i.e., close together in input space) will select a highly overlapping subset of locations in the \mathbf{A}^* set. Thus, the output response of a CMAC to similar input vectors will tend to be similar because of many memory locations in common. Hence, CMAC tends to generalize (i.e., to produce similar outputs for similar inputs.) The amount of generalization depends on the number of overlapping memory locations in the \mathbf{A}^* set.

On the other hand, any two input vectors that are dissimilar (i.e., far apart in input space) will select a highly disjoint subset of locations in the \mathbf{A}^* set. Most often, there will be no common memory locations in \mathbf{A}^* . Thus, the output response of a CMAC to dissimilar input vectors can be independent, making it easy for CMAC to distinguish between dissimilar input vectors. This means that CMAC can classify or recognize input patterns. The sparse nature of the \mathbf{A} vector makes it possible for CMAC to learn to classify a large number of patterns.

The ability to generalize between similar inputs enables CMAC to quickly learn smooth mathematical functions such as are typical of control system operators in a memory of reasonable size. The $\mathbf{S} \Rightarrow \mathbf{A}^*$ mapping and the resulting property of generalization also gives CMAC many of the properties of a fuzzy controller.

To deal with the complexity of motor behavior required to perform tasks in the natural world without either side-stepping the computational difficulties (as with teleoperated systems) or ignoring most of the relevant variables (as with conventional automation) it is necessary to partition the control problem into manageable subproblems. This may be accomplished through a hierarchical organization such as is typical in military, government, and business organizations. In a hierarchical control structure, each agent at each level of the hierarchy takes direction from a supervisor in the level above and issues directives to subordinates in the level below. Each level has its own set of knowledge, skills, and abilities. Each agent performs task decomposition by decomposing input commands from above into output commands to one or more agents at the next lower level. Agents within the same organizational unit often work together to accomplish tasks that require cooperative behavior.

CMAC modules are specifically designed to be integrated into a hierarchy wherein tasks are decomposed into subtasks at each level. At each level, the input \mathbf{S} is a combination of a command vector from a higher level plus a feedback vector from sensors or from a world model or peer agents. The output \mathbf{P} is a command to a lower level module, a next state, and possibly a message to a peer.

At each level, task commands are combined with feedback to select an appropriate subtask command to be issued to the next lower level. When command input changes, the transfer function of the CMAC can change. This enables higher level commands to select among a library of transfer functions, each of which can generate strings of task commands to the next lower level. By this process, a hierarchy of CMAC modules can decompose a complex high-level task into a string of drive signals for individual actuators as shown in Fig. 2. A hierarchy of similar building blocks in the brain can be used to implement a hierarchy of behaviors such as observed by Tinbergen [3] and others in simple creatures such as fish, birds, and insects.

CMAC was based on a neurophysiological model of the cerebellum published by Albus in 1971 and 1972 [6, 7]. This model was, in turn, inspired by a series of experiments performed by Eccles [8] and others during the 1960s that showed a striking resemblance between the structure and function of the cerebellum and the Perceptron neural net developed by Rosenblatt [9] in

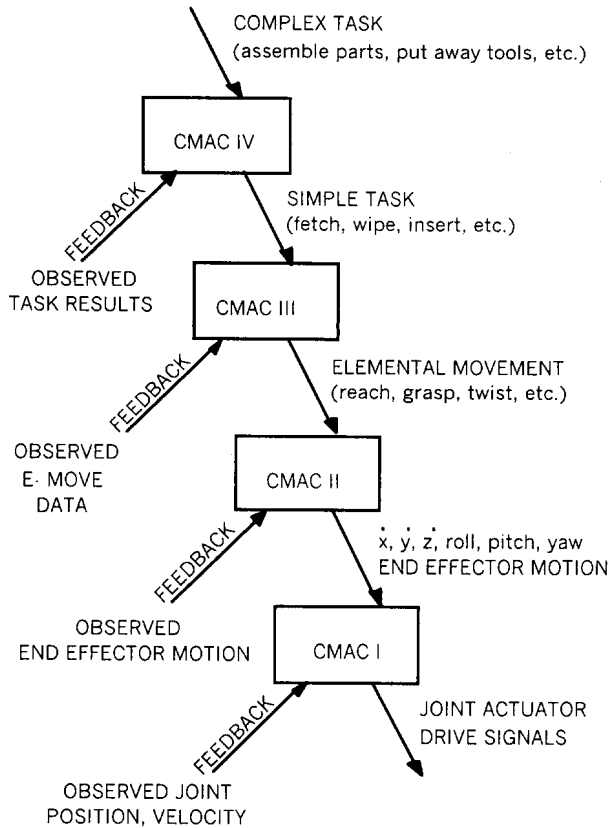

Fig. 2. A hierarchy of CMAC controllers. In response to each input command from a higher level, each CMAC generates a string of output commands to a lower level. These output commands are stimulus-response behaviors that are selected by input commands and driven by feedback variables. This hierarchy of CMACs can be used to partition a manipulator control problem into a manageable set of sub-problems.

the 1950s. The Albus model, combined with a similar model published in 1969 by David Marr [10], have become known as the Marr-Albus model of the cerebellum. The Marr-Albus model has had a profound influence on brain research in the cerebellum and remains one of the most widely accepted and frequently cited models of the cerebellum today.

The short-term impact of CMAC research was modest. CMAC was awarded an IR-100 award and a Department of Commerce Silver Medal, but had little immediate effect on the field of neural nets. At the time of its publication, the field of neural networks had fallen into a state of disrepute. Minsky and Papert had recently published their influential book entitled *Perceptrons* in which they demonstrated some of the theoretical limitations of neural networks [11]. Over-reaction to the negative conclusions of the Minsky-Papert critique had a profound impact on neural net researchers. Virtually

all interest in (and funding support for) neural network research evaporated for almost a decade. Serious interest in neural network research did not recover until the late 1980s with the invention of back propagation, adaptive resonance theory, Hopfield nets, and a number of other new discoveries.

Since 1990, CMAC has begun to attract increasing levels of interest. CMAC has been used for computing plant models for feedforward control on-line in real-time. Miller has shown that CMAC can be used to implement a real-time adaptive controller for various robotic applications [12]. Miller and others have shown that CMAC learning typically converges at least an order of magnitude faster than back propagation. As the properties of CMAC have become apparent, more and more researchers have begun to apply CMAC to their areas of interest. CMAC has become well known by students and researchers in adaptive learning mechanisms and is the subject of neural network studies in a number of laboratories in several countries. The CMAC papers have been cited in the literature over 240 times.

At least as important as its contribution to the field of neural nets, is the influence CMAC has had in providing the conceptual foundation for the Real-time Control System architecture known as RCS. The fact that CMAC could learn a set of transfer functions and transition matrices meant that a CMAC could be designed to implement any state-table or expert system rule base. The CMAC input vector (command, feedback, and state) corresponds to the IF predicate. The output vector corresponds to the THEN consequent and next state. At each compute cycle, the CMAC input vector is compared with the lines on the left side of a state table. For the matching line, the right side of the state table provides the output subcommand and next state. Thus, any CMAC can be emulated by a finite state machine. RCS is a control system built from a hierarchy of finite state machine modules.

RCS was initially developed by Barbara et al. [4] to implement controllers for sensory-interactive robots. RCS enabled NBS robots to use visual feedback to acquire randomly oriented objects and pursue moving targets. During the early 1980s, RCS evolved into the hierarchical shop control system architecture for the Automated Manufacturing Research Facility (AMRF) [5]. In the AMRF, RCS was implemented on the Horizontal Machining Workstation, the Cleaning and Deburring Workstation, the Material Handling Workstation, and the Advanced Deburring and Chamfering System. During the late 1980s, RCS was developed into a control system for the DARPA Multiple Undersea Autonomous Vehicle program and was adopted by NASA for the Space Station Telerobotic Servicer. RCS was adopted by the U.S. Bureau of Mines as a control

system for automated mining operations. At Martin-Marietta, Barbera and Fitzgerald developed RCS for the Army TMAP unmanned vehicle. Later at Advanced Technology Research Corporation, Barbera and Fitzgerald used RCS to build an Automated Stamp Distribution Center and to design a General Mail Handling Facility for the U.S. Postal Service. Commercial versions of RCS are currently being used for controlling machine tools and laser cutting machines. RCS was adapted by General Dynamics Electric Boat as a control system for the next generation nuclear submarine. At NIST, RCS has been used for the Enhanced Machine Controller, the Next Generation Inspection System, the Automated Welding Manufacturing System, the RoboCrane, a computer controlled Man-Lift, and the NIST Unmanned Ground Vehicle [13]. Most recently, RCS has been adopted by the Army for the Demo III Experimental Unmanned Vehicle program [14]. RCS is currently under consideration for the Army's Future Combat Systems program.

By the end of the century, RCS evolved into a canonical reference model architecture with sufficient structure to enable the development of metrics and interface standards for intelligent systems. Elements of RCS have been incorporated into standards activities in both civilian and military sectors. RCS is currently influencing the development of interface standards for machine tools under the Open Modular Architecture Controller (OMAC) group, and for military vehicles under the Joint Architecture for Unmanned Ground Systems Standards (JAUGS) project [15, 16].

For his work on CMAC and RCS applied to the AMRF, Albus was awarded the Department of Commerce Gold Medal, the NIST Applied Research Award, the Japanese Industrial Robot Association Research and Development Award, and the Robot Industries Association Joseph F. Engelberger Award. For the past ten years, Albus has been working on a theoretical foundation for the engineering of intelligent systems [17]. He is currently a Senior NIST Fellow in the Intelligent Systems Division of the Manufacturing Engineering Laboratory.

Prepared by James S. Albus.

Bibliography

- [1] J. S. Albus, A New Approach to Manipulator Control: The Cerebellar Model Articulation Controller (CMAC), *J. Dyn. Syst. Meas. Control, Trans. ASME* **97**, 220-227 (1975).
- [2] J. S. Albus, Data Storage in the Cerebellar Model Articulation Controller (CMAC), *J. Dyn. Syst. Meas. Control, Trans. ASME* **97**, 228-233 (1975).
- [3] Niko Tinbergen, *The Study of Instinct*, Clarendon Press, Oxford (1951).
- [4] Anthony J. Barbera, M. L. Fitzgerald, James S. Albus, and Leonard S. Haynes, RCS: The NBS Real-Time Control System, in *Robots 8: Conference Proceedings, Vol. 2*, Detroit, Michigan, June 1984, Society of Manufacturing Engineers, Dearborn, MI (1984) pp. 19-1-19-33.
- [5] J. A. Simpson, R. J. Hocken, and J. S. Albus, The Automated Manufacturing Research Facility of the National Bureau of Standards, *J. Manuf. Syst.* **1**, 17-31 (1982).
- [6] J. S. Albus, A Theory of Cerebellar Function, *Math. Biosci.* **10**, 25-61 (1971).
- [7] James Sacra Albus, *Theoretical and Experimental Aspects of a Cerebellar Model*, Ph.D. Thesis, University of Maryland, College Park, MD (1972).
- [8] John C. Eccles, Masao Ito, and János Szentágothai, *The Cerebellum as a Neuronal Machine*, Springer-Verlag, New York (1967).
- [9] F. Rosenblatt, The Perceptron: A probabilistic model for information storage and organization in the brain, *Psychol. Rev.* **65**, 386-408 (1958).
- [10] D. Marr, A Theory of Cerebellar Cortex, *J. Physiol. (London)* **202**, 437-470 (1969).
- [11] Marvin Minsky and Seymour Papert, *Perceptrons: An Introduction to Computational Geometry*, MIT Press, Cambridge, MA (1969).
- [12] W. Thomas Miller, III, Sensor-based control of robotic manipulators using a general learning algorithm, *IEEE J. Robot. Autom.* **RA-3**, 157-165 (1987).
- [13] J. S. Albus, The NIST Real-time Control System (RCS): An Application Survey, in *Proceedings of the AAI 1995 Spring Symposium Series*, Stanford University, Stanford, CA, March 27-29, 1995.
- [14] J. S. Albus, 4-D/RCS Reference Model Architecture for Unmanned Ground Vehicles, in *Proceedings IEEE International Conference on Robotics and Automation*, San Francisco, April 22-28, 2000, Institute of Electrical and Electronics Engineers, New York (2000) pp. 3260-3265.
- [15] Homepage of the OMAC Users Group (<http://www.arcweb.com/omac>), OMAC Users Group (2000).
- [16] Joint Architecture for Unmanned Ground Systems (JAUGS) (<http://www.jointrobotics.com/JaugS>), U.S. Department of Defense.
- [17] James S. Albus, Outline for a Theory of Intelligence, *IEEE Trans. Syst. Man Cybern.* **21**, 473-509 (1991).

Three Dimensional Metrology

Building a precision machine has always been a very expensive and time-consuming job. The project described in this paper [1] was part of a revolution in the design and building of precision measuring machines and machine tools. Two very important principles were described in the paper: the error correction of a measuring machine and multiple redundancy and statistical analysis of measurement algorithms. Both concepts were fairly new at the time, and by presenting a theoretical study, implementation, and an example calibration, the paper was truly a tour de force of advanced metrological thinking. A little vocabulary is needed before describing the paper.

For the machines under discussion, there are usually three axes of motion. Of course, none of these motions are perfect. There are, in fact, six main errors associated with straight line motion. A simple case of one-dimensional motion is a waybed, or linear slide. The part is supposed to move in a simple line along the Y axis. The six errors are shown in Fig. 1: scale (the slide doesn't move the desired distance), straightness (the slide can move up/down or left/right), pitch (angular motion front/back), roll (angular motion, left/right) and yaw (rotation about the Z axis).

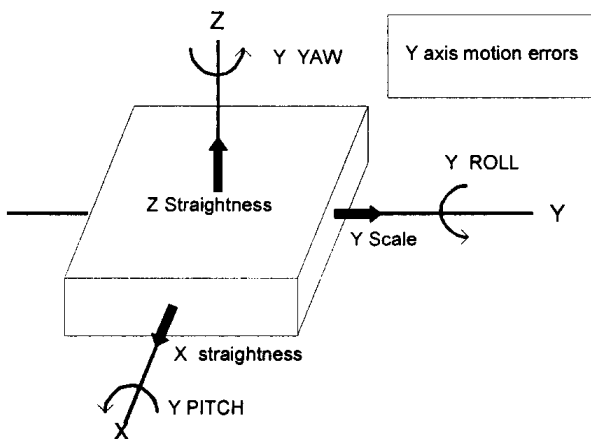

Fig. 1. Six error motions of a one dimensional waybed.

Historically, to make a precision machine the geometry of the ways needed to be as perfect as possible, an expensive and difficult job. The idea of correcting the motion of an assembled machine had been around, but was difficult to implement. There were a number of

scale correction schemes, and even some attempts to measure errors and use correction tables [2], but the process was awkward for measuring machines and not really useful for machine tools.

By the 1960s, the idea of measuring the error motions and making corrections was discussed in precision engineering circles under the name “deterministic metrology” [3]. The idea was simply that machines make errors of two kinds. Some errors are random, and thus can't be predicted or corrected; others are repeatable and thus available for mathematical modeling and correction. The impetus for this was the computer. With a computer the motion of each axis could be measured, the error put in a table, and then used rather easily because the computer did the calculations.

At NBS, John Simpson, the Director of the Center for Manufacturing Engineering, was a rather philosophical scientist [4], an early and enthusiastic believer in the idea of deterministic metrology. Under his guidance, NBS decided to implement these ideas on a three-dimensional coordinate measuring machine (CMM). One of the earliest critical decisions was which CMM to use as a test bed. A low accuracy machine would have the largest potential change in accuracy, but most low accuracy machines had large amounts of random error which could not be corrected. A high accuracy machine would have more modest potential, but would probably have small random errors. Eventually, the choice was for a high accuracy machine, an M5Z CMM from Moore Special Tool, Inc. The actual machine is shown in Fig. 2.

The M5Z was not only an extremely accurate machine to begin with, its repeatability was truly remarkable. A very good source of dimensional metrology information, and an excellent description of how to make a CMM like the M5Z, is *Foundations of Mechanical Accuracy* by Wayne Moore [5]. The X and Y motion repeatability was around 25 nm (1 microinch), and somewhat worse in Z . Thus, nearly all of the admittedly small errors could be measured and potentially corrected for in a computer program.

There were some problems. First, the best way to make the corrections with the computer would be to have the computer run the CMM. At the time the project started, there were no commercial CMMs run by computers, so NBS built a system to run the M5Z from scratch. Such an effort in the early 1970s was, in itself, groundbreaking. The second problem was that the

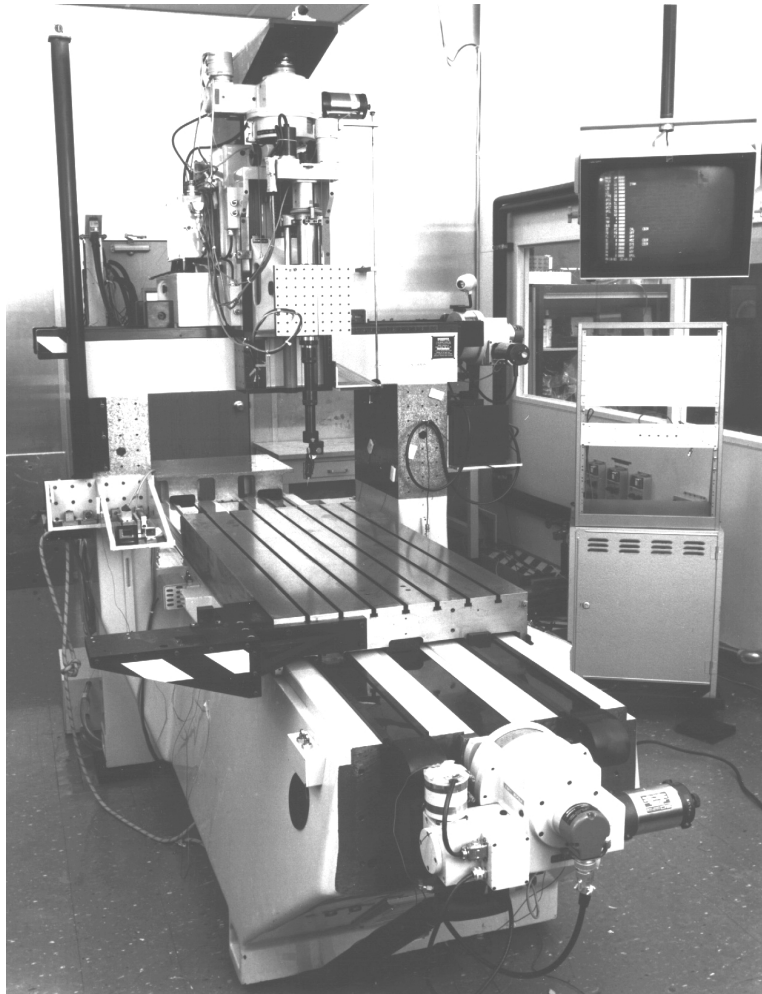

Fig. 2. Moore Special Tool M5Z Coordinate Measuring Machine

machine was much more repeatable than the precision of the major scale of the machine, the lead screw. For this, laser interferometers were added to the machine as the scales, and what was one of the most accurate lead screws in the world was used to move the machine.

Next, because of the inherent accuracy of the machine, the measurement of the motion errors was a state-of-the-art job. Fig. 3 shows a family portrait of the M5Z and some of the equipment used to map the error motions. It included external laser interferometers, straightedges, LVDTs, electronic levels, and a large amount of fixturing.

An interesting note is that there is a vertical cylinder at the center of the very bottom of Fig. 3. This is the stepper motor that provides fine motion, about 13 nm (0.5 microinch) per step. There is one for each axis. Unfortunately, step motors produce heat because they draw current all of the time. The small vertical bar in

front of the motor is a copper tube through which thermostated water was circulated to keep the motor at 20 °C.

There are other possible error motions than the six discussed earlier; they are the error motions of a rigid body. Suppose one pushes a box across the floor, but does not push at the center of the box. As it moves it will rotate. If the box is rigid the angle of rotation of all parts of the box is the same. If the box is not rigid, but can bend, the rotation measured at different parts of the box can be different. Since it was not known how the M5Z would move, or how important the bending would be, the errors were measured on a 5 cm × 5 cm × 5 cm (2 inch × 2 inch × 2 inch) lattice grid over the whole range of motion of the machine. For example, the pitch of the table was measured over the entire machine volume. Further studies showed that most machine movements can be represented in terms of rigid-body motion,

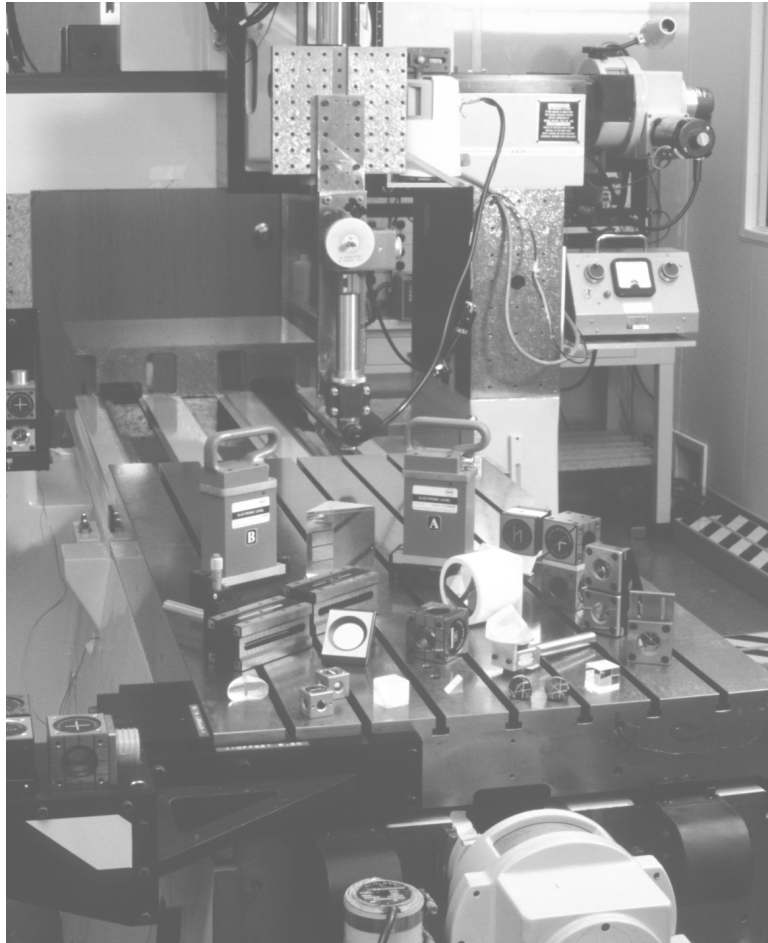

Fig. 3. M5Z and some of the equipment needed to measure the error motions of the three axes.

and consequently can be characterized fairly well with simpler measurements. For example, measurement of the table pitch along only one line, rather than a number of measurements along parallel lines, can be used. An early project to implement this simpler “rigid body” error map was completed at NBS in the early 1980s [6].

The implementation of error mapping CMMs and machine tools changed the design criteria of the machines in a very important way. Previously, a very accurate machine needed to be very repeatable and to have very small error motions. As for any system, two restraints are more expensive than one. With error mapping, the accuracy requirements could be relaxed because the error motions could be measured and programmed into the control computer or, in the case of CMMs, either the controller or the analysis computer. This made accuracy less expensive and, in fact, much of the rapid gain in CMM performance of the 1980s was based on these new design ideas. Virtually all CMMs

are now error mapped; the time between the prototype error mapping experiments to industrial implementation was only a few years.

After a brief introduction to the goals of the project, the authors of the paper [1] discuss the basic kinematics of the measuring machine. Of great importance are the definitions of the various coordinate systems and the transformations between them. The mathematical system varied greatly from paper to paper in the early years, and it took some time for a consensus to form. A reasonable discussion of these issues is given in the book edited by John Bosch [7].

The next section of the paper discusses the view of measurements as a “production process with a product, numbers, whose quality may be controlled by the methods of statistical sampling.” This is a very important idea and is a basic part of much of the NBS measurement philosophy; it was first elucidated by Churchill Eisenhart in his 1963 paper, *Realistic Evaluation of the Precision and Accuracy of Instrument*

Calibration Systems [8], described elsewhere in this volume. The idea of multiple measurements with fixturing changes (rotating grid plates between measurements, for example) to sample the uncorrected errors, as well as the simple repeatability of the instrument, has been used very successfully and is an important technique in the analysis of measurement uncertainty [9,10].

The actual machine calibration is briefly described in the next section. It is of some interest still because the quasi-rigid body assumptions are not generally used today. Thus the method described is a bit more work, but generates a better map.

Finally, the algorithm and measurement process to calibrate a ball plate are discussed. This same procedure, with repeated points to measure drift and multiple measurements in different orientations is the same basic method we use today. For more detailed information on this subject, there are a number of sources [11].

Robert Hocken earned a bachelor degree in physics at Oregon State University in 1969 and went on to a Ph.D. in physics at the State University of New York at Stony Brook in 1973. He came to NBS in 1973 as an NRC Postdoctoral Fellow and worked on the properties of fluids near their liquid-vapor critical points. From thermophysics he moved to the Dimensional Technology Group and later became Chief of the Automated Production Technology Division. These organizations were the home of the M5Z project described in the paper. From NIST, Hocken went to the University of North Carolina at Charlotte to start a program in precision engineering. As the Norvin Kennedy Dickerson, Jr., Distinguished Professor, he built what is now the Center for Precision Metrology at UNC Charlotte. This program, almost unique in the United States, has earned an international reputation for quality research in engineering and metrology. A very good introduction to Hocken and his program can be found in an article in *Quality Magazine* [12].

John A. Simpson received his B.S., M.S., and Ph.D. in physics from Lehigh University. From 1948 to 1956 he was in the NBS Electron Physics Section, rising to Section Chief. In 1971 he became Deputy Chief of the Optical Physics Section and was named Acting Chief of the Mechanics Division in 1975. In 1978 he became the first Director of the Center for Manufacturing Engineering, now named the Manufacturing Engineering Laboratory. Among his many accomplishments was the Automated Manufacturing Research Facility [13] (described elsewhere in this volume), a multi-discipline test bed for advanced concepts in manufacturing, including the deterministic metrology discussed in this paper.

Bruce Borchardt is the only author remaining at NIST. He began working summers and holidays in the Atomic Spectroscopy Division while a student at Yale. After receiving his B.S. in physics in 1971, he became a dimensional metrologist. He has worked on coordinate measurement most of his career and is one of the world's most experienced metrologists in coordinate metrology.

John Lazar was a mechanical engineer in the Dimensional Technology Section and later Automated Precision Technology Division. Besides the M5Z project, in the 1970s he designed and built a number of laser interferometer based measuring instruments for gage blocks, and a long range micrometer for wires, balls, and other common dimensional gages. Each of the instruments was about 10 years ahead of similar commercial instruments.

Charles Reeve was, at the time, a member of the division, but he specialized in the statistical analysis of calibrations. Nearly all of the documentation of the Engineering Metrology Group calibrations was written in the 1970s by Reeve. He eventually joined the Statistical Engineering Division and is currently a statistician for the Westinghouse Savannah River Co. in Aiken, South Carolina.

Phil Stein received a bachelor degree in physics from Columbia College and was one of the few graduates of the NBS-sponsored graduate program in Measurement Science at George Washington University. He worked at NBS from 1963 to 1978 and had the primary interest in the automation of the M5Z. He left NBS to pursue his interest in computers and automation and is now a private consultant. His interest in metrology and measurement also continued, and he is now a Fellow of the American Society for Quality and past Chair of the ASQ Measurement Quality Division. He also is a columnist for the Measurement Quality Division newsletter, "The Standard."

Prepared by Ted Doiron.

Bibliography

- [1] R. Hocken, J. A. Simpson, B. Borchardt, J. Lazar, C. Reeve, and P. Stein, Three Dimensional Metrology, *CIRP Ann.* **26**, 403-408 (1977).
- [2] Chris Evans, *Precision Engineering: an Evolutionary View*, Cranfield Press, Bedford, UK (1989).
- [3] James B. Bryan, The Deterministic Approach in Metrology and Manufacturing, in *Proceedings of the International Forum on Dimensional Tolerancing and Metrology*, CRTD-Vol. 27, The American Society of Mechanical Engineers, New York (1993) pp. 85-95.
- [4] John A. Simpson, Foundations of Metrology, *J. Res. Natl. Bur. Stand.* **86**, 281-292 (1981).

- [5] Wayne R. Moore, *Foundations of Mechanical Accuracy*, Moore Special Tool Company, Bridgeport, CT (1970).
- [6] G. Zhang, R. Veale, T. Charlton, B. Borchardt, and R. Hocken, Error Compensation of Coordinate Measuring Machines, *CIRP Ann.* **34**, 445-448 (1985).
- [7] John A. Bosch (ed.), *Coordinate Measuring Machines and Systems*, Marcel Dekker, Inc., New York (1995).
- [8] Churchill Eisenhart, Realistic Evaluation of the Precision and Accuracy of Instrument Calibration Systems, *J. Res. Natl. Bur. Stand.* **67C**, 161-187 (1963).
- [9] R. J. Hocken and B. R. Borchardt, *On Characterizing Measuring Machine Geometry*, NBSIR 79-1752, National Bureau of Standards, Washington, DC (1979).
- [10] M. R. Raugh, Absolute two-dimensional sub-micron metrology for electron beam lithography, *Precis. Eng.* **7**, 3-13 (1985). [11] Theodore D. Doiron, Grid plate calibration at the National Bureau of Standards, *J. Res. Natl. Bur. Stand.* **93**, 41- 51 (1988).
- [12] Samantha Hoover, A Working Education in Metrology, *Qual. Mag.*, pp. 36-39, October 1999.
- [13] J. A. Simpson, R. J. Hocken, and J. S. Albus, The Automated Manufacturing Research Facility of the National Bureau of Standards, *J. Manuf. Syst.* **1**, 17-32 (1982).

Initial Graphics Exchange Specifications

Drawings created with Computer-Aided Design (CAD) tools, which were introduced in the 1960s, represented tremendous productivity gains over paper drawings, such as ease to revise and archive. CAD tools also opened new opportunities, such as enabling manufacturing instructions to be derived automatically and executed directly from the drawing. Nevertheless, as computer design and manufacturing tools proliferated to meet increasingly complex and diverse engineering needs, so did the formats that each tool used to capture and store product data. While paper drawings can be marked up by anyone with a pencil, a product model that cannot be interpreted by the necessary CAD tool is useless. For organizations to share designs across various CAD and Computer-Aided Manufacturing (CAM) tools, their data files must be formatted in a manner that the tool can recognize. This requirement has become increasingly important in an age where large manufacturers often form joint ventures to address a business opportunity, and where partners in a supply chain are being called upon to deliver an increasingly complex array of services.

Most companies find it difficult to enforce the use of a common set of CAD/CAM tools within their organization, much less across (multiple) supply chains and among joint venture partners. Because of the lack of any common set of tools, a common format for neutral file exchange is needed. Using a neutral standard for transferring information across systems drastically reduces the requirements for translators. The cost benefits are suggested by the reduction in necessary translators shown in Fig. 1. It illustrates that by using a neutral file exchange, the number of translators (for N systems) can be reduced from scaling as $n(n-1)$ to $2n$.

In 1979, a series of events catalyzed the CAD vendor and user community to create the first national standard for CAD data exchange, which is documented in the report *Initial Graphics Exchange Specification, Version 1.0* [1]. CAD systems were less than ten years old, and only a handful of products had any significant market penetration. Even at this early stage, users were overwhelmed by the inability to share data among these tools and with their own internally developed databases.

Efficiency of a Neutral Format for Data Exchange

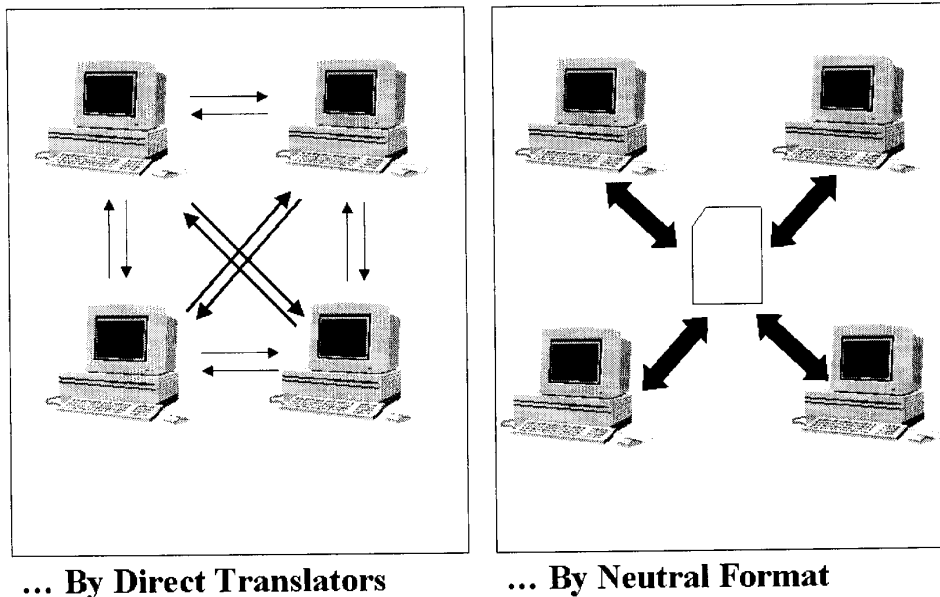

Fig. 1. Illustration of the benefits of using a neutral file exchange.

In September 1979, frustration came to a head at the two-day Air Force Integrated Computer-Aided Manufacturing (ICAM) Industry Days meeting [2]. On the first day, a representative from General Electric (GE) challenged a panel of CAD vendors, which included ComputerVision, Applicon, and Gerber, to work together to enable an exchange mechanism. While this need was intuitive from a user's perspective, this was a very threatening proposition to the CAD vendors—who feared that sharing the structure of their databases publicly would be tantamount to giving away their competitive advantage. It would have been easy to gloss over the challenge; after all, the major vendors all had at least token representation on the ANSI (American National Standards Institute) committee responsible for CAD standards. Instead, the ComputerVision representative responded with a challenge of his own: if Boeing and General Electric (and perhaps others) would contribute the CAD translators they had already developed, the vendors would share their database structures.

What led to this offer was just the right mix of business motivation and intrigue. Large Navy contracts were looming on the horizon, and no vendor wanted to look unresponsive to customer requirements.

In the evening after the panel, several interested parties gathered and asked themselves if a common translator was really possible. The room had the right mix of people and ideas at the right time. This included an Air Force, Navy, and NASA representative, each willing to fund \$25,000 for such an effort. A National Bureau of Standards representative, after a call to his boss at home for approval, was willing to champion it as chair and coordinator. The IGES Organization was formed by NBS in the spring of 1980. With the fundamentals to a common translator decided, conversation turned to a name for this new translation project. A minimalist approach was suggested:

- I** – Interim, to suggest that it would not replace ANSI's work
- G** – Graphics, not geometry, to acknowledge that academics may come up with superior mathematical descriptions
- E** – Exchange, to suggest that it would not dictate how vendors must implement their internal databases
- S** – Specification, not to be as imposing as a standard.

The panel reported on the second day, and the wheels were set in motion to create an "IGES." Once the panel admitted that a common translation mechanism was possible, it was impossible to stop the momentum of the customers' enthusiasm and expectations. Applicon and ComputerVision agreed to open up their internal databases, GE offered its internal database structure, and

Boeing supplied the structure of its Computer Integrated Information Network (CIIN) database. Both GE and Boeing contributed their existing translators. A core team formed, including representatives from NBS (Roger Nagel), Boeing (Walt Braithwaite), and GE (Phil Kennicott). Team members had worked closely with each of the vendors on internal integration projects. This prior experience built the expertise and trust needed to craft a solution in a very short time, and neither vendor felt it gave an unfair advantage to the other.

Soon after the ICAM Industry Days, NBS called an open meeting at the National Academy of Sciences (October 10, 1979). Around 200 people attended to herald the birth of IGES. There was an atmosphere of extraordinary excitement, although not everyone was readily supportive. In addition, although it was hotly debated, the name was accepted eventually with the minor change from "Interim" to "Initial."

After two critical reviews, the IGES team released its first draft in 1980, containing geometry, graphical data, and annotations. The IGES specification was brought to the ANSI Y14.26 committee for standardization. The first version of IGES was adopted as an ANSI standard, Y14.26M-1981 [3].

IGES successfully met a critical need. The IGES publication [1] establishes information structures to be used for the digital representation and communication of product definition data. The specification is concerned with the data required to describe and communicate the essential engineering characteristics of physical objects such as manufactured products. Such products are described in terms of their physical shape, dimensions, and information that further describe or explain the product. The processes that generate or utilize the product definition data typically include design, engineering analysis, production planning, fabrication, material handling, assembly, inspection, marketing, and field service. [4]

The Initial Graphics Exchange Specification is the U.S. national standard for the exchange of data between dissimilar CAD systems. The IGES standard, now in its sixth revision, has been expanded to include most concepts used in major CAD systems. All major and most minor non-PC-based CAD systems support some version of the IGES standard. Some of the over 1000 PC-based CAD systems (including all of the major ones) include some IGES support.

This first edition of IGES [1] served as a landmark to introduce a change in the way manufacturers thought about capturing and sharing their information about product data. As enhancements to the original version continued and IGES became an American National Standard, the *IGES Specification* was routinely in the top best sellers from the National Technical Information

Service (NTIS). Records show that through 1988 NTIS sold 2055 copies of *IGES 3.0*, and through 1991 sold 1295 copies of *IGES 4.0*. This U.S. national standard was also renowned internationally; it was adopted nationally by Australia, Japan, and the United Kingdom, to name a few. IGES was the precursor and provided the technical groundwork to the international standardization effort known as STEP—Standard for the Exchange of Product model data. The national and international impact on the development and deployment of product data standards in manufacturing has provided economic benefits to many implementing companies using product data standards for exchanging their data.

Examples of improvement brought about by the use of IGES include [5]:

- Electric Boat Corporation, along with the rest of the SEAWOLF (the US Navy's newest attack submarine) Team, pioneered the use of IGES to pass construction data in digital format directly from design to manufacturing.
- Honeywell Commercial Flight Systems (Minneapolis Operations), with its use of IGES, reduced engineering change orders from 40-120 (1989) to 0-3 (1991).
- Piccione Machine Tool & Gear made a significant CAD/CAM investment, using IGES for a neutral exchange format. Consequently, the process of manipulating their data was reduced from a manual operation of 200 hours to a mostly automatic process which was completed in less than two working days.
- Unique Tool & Gauge Inc.'s CAD/CAM department has the responsibility of importing customer CAD files into CAM for manufacturing. Utilizing several software packages, the company found with effective IGES translation they were able to use their IGES prowess as a competitive advantage offering services above and beyond what they were previously able to offer.

Today, IGES is still used as a universal tool, providing a neutral format for many companies to transfer engineering data between CAD/CAM systems. As of late 1999, over 25 vendors offered commercial IGES-supporting tools [6].

In 1987, the three authors of *The Initial Graphics Exchange Specification* were recognized collectively for their contributions to the development of IGES Version 1.0 by receiving the AIMTECH Joseph Marie Jacquard

Memorial Award. The first author, Roger Nagel, was a NBS staff member at the time and is now the Harvey Wagner Professor of Manufacturing Systems Engineering in the Electrical Engineering & Computer Science Department at Lehigh University. He created Lehigh's Robotics Research Institute, established and directed the Manufacturing Systems Engineering Program, and served as Executive Director of Lehigh's Iacocca Institute for Competitiveness Research. While an employee of NIST, Nagel was a key member of the scientific team developing the Factory Hierarchical Control System in the Robotics Group. This work on hierarchical control systems, performed with James Albus, Tony Barbera, and Gordon Vanderbrug, has been the basis of hundreds of computer-based control systems for automation over the last 20 years. Nagel continues to serve as a technical advisor and consultant to NIST's Manufacturing Engineering Laboratory.

The other two authors were from industry. Walt Braithwaite is currently Corporate Vice President for Company Offices Administration at the Boeing Company. He has held numerous positions within Boeing, including Director of Program Management for the 737 and 757 airplane programs and Chief of Engineering Operations for the 747 and 767 programs. As the lead engineer responsible for technical direction in developing an information network to integrate computer-aided design and computer-aided manufacturing, he led development of Boeing's common data format and translators, which were used as a basis for developing the IGES protocol.

Philip Kennicott joined the General Electric Research Laboratory in 1961 where he made contributions in the fields of x-ray crystallography and spark-source mass spectrography. As a consultant to General Electric's Computer Aided Design Center, he was instrumental in making General Electric the largest user of CAD/CAM equipment in the world in the 1970s. This work led to the concept of a neutral database, the basis for the General Electric contribution to IGES. Within the IGES community, Kennicott served as a leader of many technical activities, including Editor of the continually evolving IGES standard. He also led a technical team to develop the Department of Energy Data Exchange Format, the first IGES application protocol. He continued this work at Sandia National Laboratories in 1989 and retired from Sandia in 1997.

Prepared by Sharon J. Kemmerer.

Bibliography

- [1] Roger N. Nagel, Walt W. Braithwaite, and Philip R. Kennicott, *Initial Graphics Exchange Specification IGES, Version 1.0*, NBSIR 80-1978, National Bureau of Standards, Washington, DC (1980).
- [2] Brad Smith, Roger Nagel, and Joan Wellington, IGES—Initial Graphics Exchange Specification, in *Autofact III: Conference Proceedings*, November 9-12, 1981, Detroit, Michigan, Society of Manufacturing Engineers, Dearborn, MI (1981).
- [3] Sharon J. Kemmerer (ed.), *STEP, the Grand Experience*, NIST Special Publication 939, National Institute of Standards and Technology, Gaithersburg, MD (1999).
- [4] Initial Graphics Exchange (IGES), (<http://www.nist.gov/sc4/national/usa/iges/iges.htm>), National Institute of Standards and Technology. [5]*Product Data Exchange Technologies Success Story Booklet*, 1997 IPO Winter Meeting.
- [6] IGES Workshop/Tools, (<http://www.nist.gov/iges/igesTools.html>), National Institute of Standards and Technology.

Data Encryption Standard

In 1972, the NBS Institute for Computer Sciences and Technology (ICST) initiated a project in computer security, a subject then in its infancy. One of the first goals of the project was to develop a cryptographic algorithm standard that could be used to protect sensitive and valuable data during transmission and in storage. Prior to this NBS initiative, encryption had been largely the concern of military and intelligence organizations. The encryption algorithms, i.e., the formulas or rules used to encipher information, that were being used by national military organizations were closely held secrets. There was little commercial or academic expertise in encryption. One of the criteria for an acceptable encryption algorithm standard was that the security provided by the algorithm must depend only on the secrecy of the key, since all the technical specifications of the algorithm itself would be made public. NBS was the first to embark on developing a standard encryption algorithm that could satisfy a broad range of commercial and unclassified government requirements in information security.

Ruth M. Davis, then Director of ICST, asked the National Security Agency (NSA) to help evaluate the security of any cryptographic algorithm that would be proposed as a Federal standard. She then initiated the standard's development project by publishing an invitation in the *Federal Register* (May 15, 1973) to submit candidate encryption algorithms to protect sensitive, unclassified data. NBS received many responses demonstrating interest in the project, but did not receive any algorithms that met the established criteria. NBS issued a second solicitation in the *Federal Register* (August 17, 1974) and received an algorithm from the IBM Corp., which had developed a family of cryptographic algorithms, primarily for financial applications. After significant review within the government, NBS published the technical specifications of the proposed algorithm in the *Federal Register* (March 17, 1975), requesting comments on the technical aspects of the proposed standard. NBS received many comments on the security and utility of the proposed standard and held two public workshops during 1976 on its mathematical foundation and its utility in various computer and network architectures. After intense analysis of the recommendations resulting from the workshops, NBS

issued the *Data Encryption Standard* (DES) as Federal Information Processing Standard (FIPS) 46 on November 23, 1977 [1].

Many NBS, NSA, and IBM technical staff members participated in this initiative, which combined expertise from government and industry. In 1973 the Bureau hired Dennis Branstad to lead the new computer security project and to coordinate the DES development process. Miles Smid joined NBS in 1977 to aid in the adoption of the DES in numerous American National Standards. Both worked with their former NSA colleagues to ensure that the standard met its technical criteria and was useful in many commercial and government applications. The major IBM contributors to the design of the DES algorithm and its subsequent adoption as a Federal standard included: Horst Feistel, inventor of a family of encryption algorithms of which DES is a member; Alan Konheim and Don Coppersmith, mathematicians in the IBM research organization; Walter Tuchman, director of the IBM cryptographic competency center and the primary designer of the final DES algorithm; and Carl Meyer and Mike Matyas, who worked with Tuchman in specifying the DES and analyzing its security.

DES did more to galvanize the field of cryptanalysis than anything else. Now there was an algorithm to study. . . . Today, DES is still the primary algorithm used to protect data in the financial services industry.

After NBS published the DES, the algorithm was adopted as an ANSI standard [2] in 1981 and incorporated in a family of related standards for security in the financial services industry. The DES became the world's most widely used encryption algorithm, particularly to protect financial information. Today, the American financial services industry depends almost entirely on the DES to encrypt financial transactions.

The DES algorithm is a block cipher that uses the same binary key both to encrypt and decrypt data blocks, and thus is called a symmetric key cipher. DES operates on 64-bit “plaintext” data blocks, processing them under the control of a 56-bit key to produce 64 bits of encrypted ciphertext. Similarly, the DES decryption process operates on a 64-bit ciphertext block using the same 56-bit key to produce the original 64-bit plaintext block.

DES uses a sequence of operations, including several substitution and permutation primitives, to encrypt a data block. These primitives are subsequently used to reverse the encryption operation. Horst Feistel defined a variety of substitution and permutation primitives which are iteratively applied to data blocks for a specified number of times [3,4]. Each set of primitive operations is called a “round,” and the DES algorithm uses 16 rounds to ensure that the data are adequately scrambled to meet the security goals. The secret key is used to control the operation of the DES algorithm. Each key contains 56 bits of information, selected by each user to make the results of the encryption operations secret to that user. Any of approximately 10^{16} keys could be used by the DES, and an attacker trying to “crack” a DES encrypted message by “key exhaustion” (trying every key) must, on average, try half of the total possible keys before succeeding.

The development of the DES was not without controversy. There were two main objections:

1. NSA worked with NBS throughout the DES development, evaluated the proposed DES algorithm, and recommended several changes to IBM. Specifically, IBM made changes to the S-boxes, the nonlinear substitution transformations that are the heart of the algorithm, to improve the security of the DES. During one of the public workshops, Tuchman stated that he had changed the S-boxes to satisfy a security requirement that he had not previously known, and that his group had optimized S-box operations to satisfy a technical constraint of the electronics that they were currently using. Some critics suspected that NSA had deliberately weakened, rather than strengthened, the S-boxes, or perhaps even introduced a “trap door” that would enable the intelligence part of the agency to decrypt messages encrypted by the DES.
2. A commonly accepted definition of a good symmetric key algorithm, such as the DES, is that there exists no attack better than key exhaustion to read an encrypted message. Critics argued that the 56-bit DES key was too short for long-term security, and that expected increases in computer power would

soon make a 56-bit key vulnerable to attack by exhaustion [5]. NBS responded that the standard was adequate against any practical attack for the anticipated life of the standard and would be reviewed for adequacy every five years. Moreover, although NBS did not stress this in their public response, NBS and Tuchman knew that the “DES core” could be used three times on the same block of data to extend the effective key length to 112 or 168 bits. The critics were not satisfied, contending that encrypted data would remain sensitive for more than 5 years and that DES would be very hard to change once it became widely used.

In retrospect, the DES has proved to be much better than initially thought by its critics. After a quarter century, the DES has proved remarkably resistant to cryptanalytic attack, including attacks unknown in the open literature in the 1970s. It seems certain that, as Tuchman stated, the S-box changes did strengthen the DES in order to withstand several attacks that were not public in 1977.

However, the critics were correct about the continuing improvement in electronic technology. While the lifetime of the DES standard was originally estimated to be 15 years, it is still a Federal Information Processing standard 23 years later. Due to the improvements in technology, any 56-bit secret-key algorithm such as the DES is now vulnerable to key exhaustion using massive, parallel computations. In 1997, a message encrypted with the DES was “cracked” in about 5 months by key exhaustion using a large network of computers. In 1998, the Electronic Freedom Foundation (EFF) constructed a special purpose electronic device to decrypt messages encrypted by the DES using custom-built semiconductor chips at a cost of about \$130,000 [6]. The EFF “DES Cracker” can find the key used by the DES to encrypt a message in an average of about 4.5 days, and using more chips could reduce this time.

The current Data Encryption Standard (FIPS 46-3) [7] recommends an iterative use of the original DES algorithm (as the DES development team envisioned in the 1970s) known as “Triple DES” or “DES-3.” DES-3 encrypts each block three times with the DES algorithm, using either two or three different 56-bit keys. This approach yields effective key lengths of 112 or 168 bits. DES-3 is considered a very strong algorithm, and one recent paper [8] suggests that a 112-bit symmetric key algorithm such as DES-3 should be secure until about the year 2050. The original 56-bit DES algorithm is widely used to protect financial transactions today and can easily be modified to be interoperable with DES-3 and a 112-bit key. Some cryptographers regard DES-3 as the most conservative

choice for very long-term data protection, since the core DES algorithm has been so thoroughly analyzed.

NIST not only made a significant contribution in technology through its development of the DES, but also gained valuable experience in developing such important, but potentially controversial, standards. In 1997, Miles Smid, then manager of the Security Technology Group, initiated the Advanced Encryption Standard (AES) development project. The anticipated AES, is intended to be the DES successor and, like the DES, will be a symmetric key block encryption algorithm. The AES will offer larger key sizes (up to 256 bits) than the DES. However, since DES-3 appears to be secure for some time in the future, the primary near term advantage of the AES is that it will be designed for software implementation and be much faster than DES-3 on most platforms. Barring some unforeseen breakthrough in cryptanalysis or computing power, the AES should be secure for many decades. In response to a public solicitation by NIST, interested parties submitted 21 candidate algorithms to be considered for adoption as the AES. Of those submitted, fifteen met NIST's initial criteria for consideration and five very good algorithms were selected in August 1999 for additional analysis and review. NIST expects to announce the final selection in 2001. NIST, having gained increased stature within the security technology community through its experience gained by its DES initiative, is able to conduct the selection process in an open manner that virtually precludes suspicion of secret trap doors.

Dennis Branstad, who shepherded the development of the original DES, received his Ph.D. in Computer Science from Iowa State University, and worked at the National Security Agency before coming to NBS in 1973. Denny is widely respected in the cryptographic community for his technical abilities, his sage judgment and his considerable interpersonal skills. He has been a mentor and friend to many in the Computer Security Division. At the time of his retirement in 1994, Denny was a NIST Fellow.

Miles Smid received his BS in mathematics from the Univ. of Chicago and his MA in mathematics from the Univ. of Maryland. Miles came to NBS from the National Security Agency in 1977 and worked on the development of numerous Federal Information Processing Standards and ANSI standards in cryptography. Miles was the manager of the NIST Security Technology Group through most of the 1990s, a difficult period of contentious, highly charged policy as well as technical issues in cryptography. Nevertheless, he managed to be respected by nearly everyone, whatever their policy

views, as both a cryptographer and a "straight shooter." Miles orchestrated the still ongoing AES effort in a manner that seems to have satisfied a very broad range of often-contentious interests and which promises to result in a very broadly accepted and used standard. Miles was Acting Chief of the Computer Security Division at the time of his retirement in 1999.

The DES can be said to have "jump started" the nonmilitary study and development of encryption algorithms. In the 1970s there were very few cryptographers, except for those in military or intelligence organizations, and little academic study of cryptography. There are now many active academic cryptologists, mathematics departments with strong programs in cryptography, and commercial information security companies and consultants. A generation of cryptanalysts has cut its teeth analyzing (that is trying to "crack") the DES algorithm. In the words of cryptographer Bruce Schneier [9], "DES did more to galvanize the field of cryptanalysis than anything else. Now there was an algorithm to study." An astonishing share of the open literature in cryptography in the 1970s and 1980s dealt with the DES, and the DES is the standard against which every symmetric key algorithm since has been compared.

One of the consequences of this development of non-military cryptography has been validation of the basic model of public specification and review of encryption algorithms that NBS pioneered with the DES. The DES is well trusted because it has been so intensely studied, but the past 20 years are replete with examples of algorithms designed in secret, whose users attempted to keep the algorithm secret. In many of these cases, not only was the algorithm exposed by reverse engineering or by leaks, but the algorithm, or the overall cryptographic system that used it, was also shown to be insecure after it was already in wide use in products such as digital cellphones or digital video disk players. In addition, many software products offer ad hoc, home-brew encryption which has been cracked by experts after only a few days of study, and there are commercially available products that decrypt files protected by such programs. Time has shown that the public approach NBS chose for developing the DES standard was the best approach from a security point of view. Security by obscurity does not work.

In summary, the DES was a pioneering and farsighted standard which helped set a new paradigm for openly published and reviewed encryption standards. The DES has been an enormously useful and influential standard and remains, when used in its Triple DES mode, secure today, a quarter century after it was first proposed. It is

also, today, still the primary algorithm used to protect data in the financial services industry. The new AES standard builds on the legacy of DES and should meet our needs well into the new century.

Prepared by William E. Burr.

Bibliography

- [1] *Data Encryption Standard*, Federal Information Processing Standards Publication (FIPS PUB) 46, National Bureau of Standards, Washington, DC (1977).
- [2] *Data Encryption Algorithm (DEA)*, ANSI X3.92-1981, American National Standards Institute, New York.
- [3] Horst Feistel, Cryptography and Computer Privacy, *Sci. Am.* **228** (5), 15-23 (1973).
- [4] Horst Feistel, *Block Cypher Cryptographic System*, US Patent 3,798,359, March 19, 1974.
- [5] Whitfield Diffie and Martin E. Hellman, Exhaustive Cryptanalysis of the NBS Data Encryption Standard, *Computer* **10** (6), 74-84 (1977).
- [6] Electronic Frontier Foundation, *Cracking DES: Secrets of Encryption Research, Wiretap Politics and Chip Design*, O'Reilly & Associates, Inc., Sebastopol, CA (1998).
- [7] *Data Encryption Standard (DES)*, Federal Information Processing Standards Publication (FIPS PUB) 46-3, National Institute of Standards and Technology, Gaithersburg, MD (1999).
- [8] Arjen K. Lenstra and Eric R. Verheul, Selecting Cryptographic Key Sizes (<http://www.cryptosavvy.com/>) October 1999.
- [9] Bruce Schneier, *Applied Cryptography, Protocols, Algorithms, and Source Code in C, Second edition*, John Wiley and Sons, New York (1996) p. 267.

OMNIDATA and the Computerization of Scientific Data

For much of its history, the National Bureau of Standards has been a leader in providing the most reliable available technical data to scientific and engineering users. The Bureau has operated large-scale data evaluation programs in a wide variety of disciplines and has distributed the results through various publication channels. With the advent of modern computers, it was natural for NBS data experts to explore how computers could be used both for internal data management activities and for the public dissemination of NBS data collections. During the 1970s, the Office of Standard Reference Data (OSRD) and the various data centers that it coordinated embarked on a number of projects aimed at utilizing the growing power of digital computers to improve the efficiency and effectiveness of the SRD program. NBS quickly became recognized as a pioneer in this area.

At that time, there was a tendency for each data group to develop computer programs to handle the particular type of scientific data of concern to it. Since the SRD program covered such diverse classes of data, there was an incentive for OSRD to investigate the possibility of developing general purpose programs capable of managing a broad range of data. This effort led to the creation of the database management program OMNIDATA, described in the book *OMNIDATA, An Interactive System for Data Retrieval, Statistical and Graphical Analysis and Data-Base Management: A User's Manual* [1], authored by Joseph Hilsenrath and Bettijoyce Breen. This represents the first major publication of the National Bureau of Standards in the area of computerized scientific data management.

In the early 1970s when the OMNIDATA project was begun, data retrieval, data analysis, and data file maintenance were largely done in the batch mode, with programmers submitting punched cards for processing on a mainframe computer and, after an indeterminate period of time, receiving a printout of results. Also, computer programs designed to run routinely were almost always inflexible, and the writing of ad hoc programs to answer specific questions often entailed expense and delay out of proportion to the urgency of the problem that motivated the question in the first place. When early commercial general-purpose data management programs began to appear, primarily intended for business applications, they had adequate and roughly comparable search and retrieval capability, file defini-

tion features, and report generators. None, however, had enough data analysis and data manipulation facilities to handle the numerical and alphanumeric data files required for scientific use, nor did they address unique characteristics of scientific information, such as Greek and mathematical symbols, uncertainties, and varying number of significant figures, all of which added to the complexity to scientific data.

OMNIDATA was designed to overcome many of these shortcomings. Programs were written to analyze and store data. Rudimentary graphics packages created visualizations of data. The 45 unique modules and the supervisory program of the OMNIDATA system could be used not only by the computer professional, but also by the novice with little or no knowledge of computers. It could be run in demand mode, interactively from a computer terminal on a time-shared computer system. In addition to handling such administrative files as personnel, training, inventory, and travel, the system was robust enough to handle diverse scientific data files, including crystal structure data, thermochemical data, chemical kinetics data, and data on physical properties. Finally, OMNIDATA was designed and written to be modular, a hallmark of truly efficient computer programming and systems design, and a visionary precursor to what is today called component-based software.

Most of the individual modules provided tools for data retrieval, analysis, and reporting. Specifically, the system had facilities for searching and reporting; plotting and graphical analysis; arithmetic operations in general, and statistical analysis in particular; file partitioning and subsequent sequential analysis on subfiles; keyword indexing of bibliographic files; flagging, coding, and decoding of data items; analysis of questionnaires and surveys; and a large variety of data management and validation routines of use to both the end user of the data and the database administrator. An important feature of OMNIDATA was its ability to convert data files from other formats for use in the OMNIDATA system and to generate data arrays that could be accessible to other programs written in languages including FORTRAN, COBOL, and X BASIC. Also, the OMNIDATA system interfaced with the OMNITAB II program [2], used extensively at NBS and elsewhere, to provide a repertory of well-tested and highly accurate statistical routines.

The OMNIDATA system allowed for flexibility in file size. With it, one could profitably automate files from those with few records of a small number of data elements to elaborate databases of many records with numerous data fields. In contrast to other management information systems of the era, which limited the number of data items that could be searched or manipulated, each module in OMNIDATA was capable of operating on every data item, and the user could search on any field, even down to the character level. Its modularity, flexibility, and data analysis capabilities made OMNIDATA unique. It was a forerunner of the database management systems marketed today and the systems so essential to the functioning of the World Wide Web.

The use of OMNIDATA quickly spread to other parts of NBS, beyond the Standard Reference Data Program, so much so that there were continuing problems in providing support and extensions for a diverse group of users. The legacy of OMNIDATA was not the software itself, but the realization that scientific data projects could successfully convert to computerized operation—and that they would have to do so in order to continue as viable projects.

The lessons of OMNIDATA were critical to the push to computerize both the internal data operations and the dissemination of databases, which began in earnest in the 1980s. The effort was led by Bettijoyce Breen and John Rumble, Jr., who joined the Office of Standard Reference Data in 1980. During this decade every NBS/NIST data activity created databases of references containing the data of importance to its area of responsibility. Many developed specialized data entry programs that captured not only this bibliographic information, but also the numeric tabular and graphical data contained therein. In addition, the data centers developed suites of software that supported data evaluation through the use of discipline specific analysis, statistical procedures, and correlation techniques. At the beginning of this effort, most of the software incorporated the ideas found in OMNIDATA, with significant extensions to take care of specialized requirements.

Many of the data handling software packages developed at NBS were used by outside organizations. The NIST Crystal Data Center developed AIDS 80, a powerful package that evaluated and managed crystallographic data [3]. The NIST Alloy Phase Diagram Data Center created a suite of graphical digitization and database management tools that supported the international Alloy Phase Diagram Program run jointly by the American Society of Metals and NBS [4]. A similar set of graphics software was developed for handling ceramics phase diagrams under the NBS-American Ceramic Society Phase Diagram for Ceramists Program [5].

The computerized dissemination of NBS collections of evaluated data proceeded likewise. In the late 1970s, NBS worked with the Environmental Protection Agency and the National Institutes of Health to create and operate the Chemical Information System (CIS), which was the first online system to provide scientific numerical data. The CIS featured a powerful substructure and nomenclature search system that allowed users not only to search for data on a specific substance, but also to identify classes of chemical compounds with particular structural features. The CIS integrated databases built by many groups, including NBS thermochemistry and crystallographic data centers.

At the same time, the Standard Reference Data program began offering magnetic tapes of formatted data files suitable for outside users to load onto their own mainframe computers. It was the responsibility of the users to build their own search software and to manage the data. The PC revolution of the 1980s changed all that, and OSRD quickly began offering files similar to those on magnetic tapes on floppy disks. It soon realized, however, that users wanted self-contained packages that were easy to install and that included built-in user interfaces. By 1985 two systems were under advanced development. Steve Stein, then of the Center for Chemical Physics, was building an MS-DOS mass spectral data system, and Chuck Wagner of Surfex and John Rumble, Jr., of NBS were building an x-ray photoelectron spectroscopy (XPS) database on an Apple platform. The mass spectral database was released in 1987 and became an immediate success. Today it is incorporated into virtually every mass spectrometer sold. The next two years saw many other NBS databases released including the XPS database.

In 1982, NBS scientific database management efforts addressed another area, that of materials data. In November of that year, NBS cosponsored with FIZ Karlsruhe (a German government technical information center) and CODATA (the ICSU Committee on Data for Science and Technology) a workshop on computerized materials data. This Fairfield Glade meeting, named after its location in Tennessee, spawned an international activity to build an online materials data system. The proceedings from that workshop, *Computerized Materials Data Systems* [6], edited by Jack Westbrook and John Rumble, Jr., were widely circulated worldwide and became the “bible” for planning such an online system. The seminal meeting addressed the full range of topics related to online materials data systems, including their scope, user interfaces, system development, legal and economic issues, and barriers to be overcome. The Fairfield Glade Workshop concluded that it was not only possible to build such a system, but that one should be built as soon as possible.

Over the next five years, over 15 additional workshops were held covering the full range of engineering materials disciplines, potential user industries, and many other aspects. A prototype system was built with funding from NBS, the Department of Energy, and the Department of the Army. The Metals Properties Council, a trade association of the metals industry, worked with NBS and other groups to establish the non-profit Materials Property Data Network (MPDN). The MPDN, which soon became part of the STN dial-up network of the Chemical Abstracts Service, was a successful online data system in the pre-Internet era.

One offshoot of this effort was the establishment of ASTM Committee E49 on Computerization of Materials Properties Data. This committee, which was chaired by John Rumble from 1988 to 1993, rapidly became the international focal point for standards relating to all aspects of the computerization of materials data, and these standards are in wide use today.

The blossoming of NBS/NIST computerized data dissemination continued unabated until about 1994, when two concurrent changes hit the computer world. These were the release of the Microsoft Windows operating system and the Internet explosion. In one short period, the NIST PC databases and older online systems such as the MPD Network became obsolete as users demanded Windows versions of existing MS DOS data products. In addition, the Internet, and especially the World Wide Web, revolutionized online data delivery. Where previous online systems required years of development, the Web required only months of work. At the present time, NIST operates 15 Web-based data systems that receive thousands of users every day.

Today's scientific database environment is a long way from the mainframe world of 1976 when Hilsenrath and Breen issued their first manual for OMNIDATA, and even of 1986, when the first MPDN prototype came online. These changes have made the creation of databases considerably easier and have brought easy access for users worldwide to the full range of NIST evaluated data. The ideas in *OMNIDATA* and *Computerized Materials Data* were germinal in articulating the core principles of scientific database management and online dissemination. The distance traveled since then is a tribute to Hilsenrath, Breen, and Rumble and their foresight in leading NBS to the forefront of computerizing scientific data.

Joseph Hilsenrath began his career at NBS in 1948, first as a scientist/mathematician specializing in employee training, then as an experimental researcher in

high pressure physics, after which he became Chief of the Equation of State Section of the Heat Division. As the first computers became available at NBS, he became interested in the preparation of tables of thermodynamic data and in putting computer know-how in the hands of Everyman. His OMNITAB statistical packages received wide use in NBS and other Government agencies. He moved to the Office of Standard Reference Data in 1967, where he led the development of computerized typesetting methods that saw use throughout the Government. He retired in 1974, but for many years remained active in NBS reference data activities.

Bettijoyce Breen joined NBS in 1969 as a computer programmer for the Office of Standard Reference Data after receiving her B.S. in chemistry from William and Mary College. After completion of the work on OMNIDATA, she supervised the introduction of the next generation of computerized typesetting technology into NBS and later became head of the OSRD Data Systems Development Group. This group helped the various data centers in NBS and elsewhere to automate their operations and oversaw the preparation of database packages for public dissemination. She received an M.S. in Chemical Information from American University in 1975 and became active in the Chemical Information Division of the American Chemical Society, serving as both Treasurer and Chair of the Division. In 1990, as Bettijoyce Breen Lide, she joined the NIST Advanced Technology Program (ATP), where she set up the first ATP management information system. As an ATP program manager, she established the program on Information Infrastructure for Healthcare and later headed the Information Technology and Applications Office. In 1999 she received the George Uriano Award of NIST for fostering industrial-government interactions.

John Rumble, Jr. joined NBS in 1980 as the OSRD program manager for materials data. In addition, he played a strong role in computerizing NBS/NIST data activities in all disciplines. Rumble became Chief of the Office of Standard Reference Data in 1994. He has been active in many activities related to standards for scientific and technical information and was elected President of CODATA in 1998. He is also a Fellow of the ASM International and the American Society for Testing and Materials.

Prepared by John R. Rumble, Jr.

Bibliography

- [1] Joseph Hilsenrath and Bettijoyce Breen, *OMNIDATA, An Interactive System for Data Retrieval, Statistical and Graphical Analysis and Data-Base Management: A User's Manual*, NBS Handbook 125, National Bureau of Standards, Washington, DC (1978).
- [2] Joseph Hilsenrath, Guy G. Ziegler, Carla G. Messina, Philip J. Walsh, and Robert J. Herbold, *OMNITAB: A Computer Program for Statistical and Numerical Analysis*, NBS Handbook 101, National Bureau of Standards, Washington, DC (1966); David Hogben, Sally T. Peavy, and Ruth N. Varner, *OMNITAB II: User's Reference Manual*, NBS Technical Note 552, National Bureau of Standards, Washington, DC (1971).
- [3] A. D. Mighell, C. R. Hubbard, and J. K. Stalick, *NBS*AIDS80: A FORTRAN Program for Crystallographic Data Evaluation*, NBS Technical Note 1141, National Bureau of Standards, Washington, DC (1981).
- [4] Thaddeus B. Massalski (ed. in chief), *Binary Alloy Phase Diagrams, Vols. 1-3, Second Edition*, ASM International, Materials Park, OH (1990).
- [5] Richard M. Spriggs and Stephen W. Freiman ACerS/NIST Phase Equilibria Update, *Am. Ceram. Soc. Bull.* **75** (1), 83-85 (1996).
- [6] J. H. Westbrook and J. R. Rumble, Jr., *Computerized Materials Data*, National Bureau of Standards, Gaithersburg MD (1983).

FORTRAN Test Programs

The career of Frances E. (Betty) Snyder Holberton, the lead author of SP 399, *NBS FORTRAN Test Programs* [1], closely tracks the evolution of information technology (IT) for the four decades following World War II. Her work at NBS (1966-1983) and her leadership in preparing this landmark publication are best understood in the context of her earlier career.

Her first work remains perhaps the most notable: she was a member of the first team of programmers (composed of six women) to work on the ENIAC [2,7], the first operational, general purpose, electronic digital computer. “Programming” in those early days did not consist of writing code; rather, it meant setting thousands of switches and connecting dozens of cables so as to route data correctly through the machine. ENIAC was built at the Moore School of Electrical Engineering at the University of Pennsylvania. Completed in late 1945, it is widely regarded as a milestone in the history of computer technology. After five years at the Moore school, Holberton left in 1947 to work at the Eckert-Mauchly Electronic Control Company to participate in the development of the UNIVAC.

Her work on the UNIVAC included the development of the C-10 language, one of the first to use mnemonic (symbolic) instructions (e.g., “a” for add, “b” for bring). She also wrote the first sort-merge software, notable as perhaps the first case of a program whose function was to generate another program—a key idea in the notion of a programming language compiler. Compilers make it possible to express computer programs in high-level languages, such as FORTRAN, C, or Java, instead of the low-level instructions which are directly processed by the computer hardware. A line of FORTRAN, such as

```
ANGLE = ATAN (SGMENT / SQRT(X*X + Y*Y))
```

will typically generate several instructions in machine language (so-called object code); producing this machine code directly would be quite tedious and error-prone.

From the appearance of the line of FORTRAN above, one might reasonably guess that its purpose is to square two quantities, labeled X and Y, add them, take the square root of that sum, divide that quantity into SGMENT, take the arctangent of the quotient and save the result as ANGLE. All well and good, but will this line of code work equally well (or work at all) when

processed on different vendors’ machines? Note that vendors A and B may well have completely different underlying hardware (i.e., their low-level machine codes are not the same). Furthermore, each has very likely written its own compiler—so the translation process itself from FORTRAN (the so-called source code) to machine code may well be different. Even assuming that the A and B compiler-writers make no unintentional errors, we still need to make sure that they are working toward the same goal. The very notion of a formal language implies strict rules about the spelling and meaning of its expressions [4,6]. For instance, the square root function must be spelled “SQRT,” not “SQROOT.” Furthermore, even assuming that both compilers accept the standard spelling (i.e., they accept the source code and generate machine code), the problem of semantics remains. For instance, in our example, does the arctangent function return its result in degrees or radians? COBOL and FORTRAN standards committees were established [8] to ensure that just such issues were resolved in a uniform way, and Betty Holberton was an active participant on these committees. As a result, software written according to the standard could be expected to run consistently on a wide variety of machines. Given the cost of developing large software products, this is no small benefit.

By the early 1960’s, industry standards for high-level languages such as FORTRAN and COBOL were becoming widely accepted. One problem remained: how to be sure that the standard was being implemented correctly by the various vendors? Put another way: how to measure the validity of the compiler software itself?

Although metrology had always been a core function of NBS, devising measurement methods for information technology nonetheless represented a novel challenge. Previous work had typically addressed the measurement of physical quantities, such as temperature, electrical charge, mechanical strength, composition, etc. But many of the artifacts of information technology are essentially logical structures. True, software is realized on some physical medium, but most often it is the logical behavior of the software that is of greatest interest, not the details of its physical implementation. (Of course, NBS has had a hand in developing tests for the physical media of computers as well.)

One way to determine the validity of a piece of software is simply for a skilled programmer to read it;

indeed, code review is an important part of the software engineering process. Nonetheless, such a subjective procedure could hardly serve as the basis for an “official” determination that a compiler did or did not conform to the language standard. Moreover, there are operational issues: how well trained are the reviewers? How long would it take them to verify a single compiler? There was a need for a largely automated and objective method for checking compiler conformance to the standard.

This was the problem addressed by Holberton and her colleague Elizabeth Parker in *NBS FORTRAN Test Programs*. Their solution was a set of test programs that methodically exercised all the features of the language to be checked. If the routines were accepted by the compiler and generated the expected output, then the compiler was basically reliable (although no finite set of tests could ever prove that a compiler is completely correct). If not, then the errors would be noted and reported back to the vendor for correction. At first, the only official use of the test sets was to certify conforming implementations, which were then eligible for purchase by Federal agencies. Of course, this provided a strong incentive for vendors to produce standard-conforming software. In time, the idea of test sets to support software standards became widely accepted. This basic strategy is used to this day to validate software development tools, such as language compilers for C and Java and so-called Application Programmer Interfaces (APIs) such as SQL (for database operations) and OpenGL (for 3-D graphics). Since the same programs are used for all vendors, the testing process is transparently fair and objective. Of course, a human operator has to run the tests and examine the output, but this is not much different than a chemist obtaining the results of an experiment from a balance or other measuring instrument.

Furthermore, the test programs were ordered, checking the most basic language features first and then progressing to the more sophisticated aspects. This gave the operator good evidence about which features were the cause of any failures detected. NBS/NIST has since participated in the design, development, and operation of several comprehensive software test sets [3]. It should be stressed that, while the operation of the tests is mostly automated, the development of the tests requires a high degree of skill and understanding of the standard being applied. Test sets often comprise tens, or even hundreds

of thousands, of lines of code. Conformance testing remains an important part of the NIST mission [10].

Betty Holberton worked for Remington-Rand in the early fifties, and then began her long career in government, first at the Applied Mathematics Laboratory of the David Taylor Model Basin (1953-1966), then at the National Bureau of Standards until her retirement in 1983. Her government work was spent largely in the development and testing of standards for computer languages. In 1997, her many achievements were recognized by the Association for Women in Computing, which presented her with its highest honor, the Augusta Ada Lovelace Award [9]. Also in 1997, Women in Technology International (WITI) inducted all six of the original ENIAC programmers into their Hall of Fame [5].

Prepared by John Cugini.

Bibliography

- [1] Frances E. Holberton and Elizabeth G. Parker, *NBS FORTRAN Test Programs*, NBS Special Publication 399 (3 volumes), National Bureau of Standards, Washington, DC, October 1974.
- [2] Rachel K. Adelson, *Programmed to Succeed: Betty Holberton* (<http://www.awc-hq.org/livewire/199705.html>), Association for Women in Computing.
- [3] J. Cugini, *Interactive Conformance Testing for PHIGS, Eurographics '91*, September 1991 (<ftp://ftp.nist.gov/pub/vvrg/pvt/pvt-design.ps>). This paper discusses some recent issues in the application of conformance testing to graphics.
- [4] I. D. Hill and B. L. Meek, *Programming Language Standardisation*, Ellis Horwood Ltd., Chichester, England (1980).
- [5] Kathryn A. Kleiman, Speech for WITI 1997 Hall of Fame Ceremony (<http://www.witi.com/center/witimuseum/halloffame/1997/eniac.shtml>), Women in Technology International.
- [6] Terrence W. Pratt, *Programming Languages: Design and Implementation*, 2nd ed., Prentice-Hall, Englewood Cliffs, NJ (1984).
- [7] Thomas Petzinger, Jr., *The First Computers Were The Women Who Invented Programming* (<http://members.aol.com/dougaseby/Page83.html>). *Wall Street Journal* article on ENIAC programmers, November, 1996.
- [8] American National Standard FORTRAN, ANSI X3.9-1966. This is the original FORTRAN standard, long since superseded by more recent versions.
- [9] Announcement of the 1997 Augusta Ada Lovelace Award (<http://www.awc-hq.org/lovelace/1997.htm>), Association for Women in Computing.
- [10] Homepage of the NIST Software Diagnostics and Conformance Testing Division (SDCT) (<http://www.itl.nist.gov/div897/>), National Institute of Standards and Technology.

Design and Evaluation Criteria for Energy Conservation in New Buildings

In the early 1970s, one-third of the energy consumed in the United States was used to heat and cool buildings and to provide illumination, water heating, and other building services. Shortages of fuel oil, gas and electricity were quite prevalent on a localized basis in the winter of 1972-73. Temporary closing of schools, shutdowns of industry and government facilities during spells of severe weather, and electrical brownouts created strong demands in several states for regulations that would provide for equitable distribution of available supplies during periods of shortage. Responding to these demands in the spring of 1973, the National Conference of States on Building Codes and Standards (NCSBCS) requested the National Bureau of Standards (NBS) to develop a set of design and evaluation guidelines for energy conservation in buildings that states could use pending development of a national consensus standard. These requirements were to be nationally applicable and effective for buildings of all types. NBS drew on its long-term research expertise in the prediction and measurement of building thermal performance and lighting to formulate a technically and economically effective approach to the design of new energy-conserving buildings. In February 1974, shortly after the OPEC oil embargo, NBSIR 74-452, *Design and Evaluation Criteria for Energy Conservation in New Buildings* [1], became available for use.

Most states have delegated their constitutional authority for establishing and enforcing building codes to local units of government. In the late 1960s, Charles T. (Chuck) Mahaffey of NBS conceived a plan to address the problem of non-uniformity in U.S. building codes and standards, based on the way the states and NBS cooperated in the National Conference of Weights and Measures, Cement and Concrete Reference Laboratories (CCRL), and American Association of State Highway and Transportation Officials (AASHTO). As an outgrowth of an exploratory meeting in which state officials in Wisconsin played a major role, NCSBCS was formed on November 20, 1967, at an organizational meeting attended by delegates from 16 states. It was agreed that NCSBCS would provide a forum for discussing administrative problems in building regulation at the state level, and develop and seek adoption of uniform and comprehensive state

building codes and standards. NBS officially furnished secretariat services from April 1970 until October 1976, housed NCSBCS until September 1976, and continued to provide technical support [2,3,4].

NCSBCS soon took up the question of regulations to conserve energy use in buildings. Its Standards and Evaluation (S&E) Committee noted that "the sense of urgency connected with the energy crises may cause some states to enact hastily prepared legislative requirements ill-suited to solving the national problems involved." At the Committee's request, Paul R. (Reece) Achenbach summarized NBS research in the field of energy use in buildings. As a result, the Committee members voted as follows:

1. [We] endorse the concept that energy conservation is of national concern and that related building design and construction is properly a building code subject.
2. Consistent with state NCSBCS objectives, uniform national performance-oriented reference standards should be generated.
3. [We] request continued NBS activity in this area, and specifically the following: Report to the S&E Committee with recommendations on the possible content and strategy for generation of a building related energy conservation reference standard, including the consideration of cost implications. Since the scope of building codes had historically been limited to life safety issues, Item 1 led to a major shift in building regulatory policy in the United States (and Canada).

In August 1973, NCSBCS formally asked for NBS assistance in developing a four-part energy conservation program, including development of a draft performance standard for state regulatory reference and call for a sponsor to act as the secretariat for eventually processing the standard through the American National Standards Institute (ANSI). NBS agreed: 1) to develop the design and evaluation criteria for energy conservation in new buildings (NCSBCS would offer these to a suitable sponsor as a basis for developing an energy conservation performance standard); and 2) to advise NCSBCS on options for advancing its criteria through the consensus process.

The 1974 energy document was developed by a 15-man NBS Task Group and 5 advisors with Reece Achenbach as Program Manager and Jim Heldenbrand as Project Manager. The Task Group investigated a number of different approaches, rating as most likely to attain the objectives a “framework of performance standards supported by performance requirements of subelements.” It was chosen largely because available technical knowledge and economic tools limited a broader performance approach, and because time was short.

The resulting document [1] was regarded as primarily a component performance approach, but it also contained some specification (prescriptive) requirements and had some features of a building performance standard. As illustrated in Fig. 1, it provided three design paths for obtaining a building with acceptable design energy requirements. The basic approach was to describe the performance criteria for the components of a building envelope, and the heating, air conditioning, ventilating, domestic water heating, and lighting systems to provide for efficient use of energy. Having first determined the annual energy requirement of a given design in accordance with this basic approach, the designer could use any other combination of building and equipment characteristics that would require equal or less energy on an annual basis for the same building function. Under the third alternative, the designer would receive a bonus of up to half of any energy supplied by solar or wind-powered equipment in determining the annual energy requirements for the proposed building.

The 1974 document saw a need for more energy and economic information to improve the energy performance criteria. The information fell into four areas:

1. procedures and data for determining economic efficiency;
2. energy analysis data
 - part-load efficiency data; control characteristics
 - air distribution
 - standard weather data for energy analysis
 - engineering data for nonconventional systems
 - simplified and reliable energy calculation procedures;
3. testing procedures;
4. infiltration.

NBS was positioned to advance the state of research-based data and procedures in several of these areas. The building energy conservation program at NBS accelerated in the early 1970s, having begun with heat transfer work by the Heat Division in the first 10 years of NBS’ existence and continued with the establishment of the Building Technology Division in 1947 with Douglas Parsons as its Chief. In the 1960s this work was conducted in the newly established Building Research Division with James R. Wright as Chief. Much of the building research work is documented in two series of publications, *Building Materials and Science* (over 150 publications) and the current *Building Science Series*. Building research through 1968 was well documented by Achenbach [5].

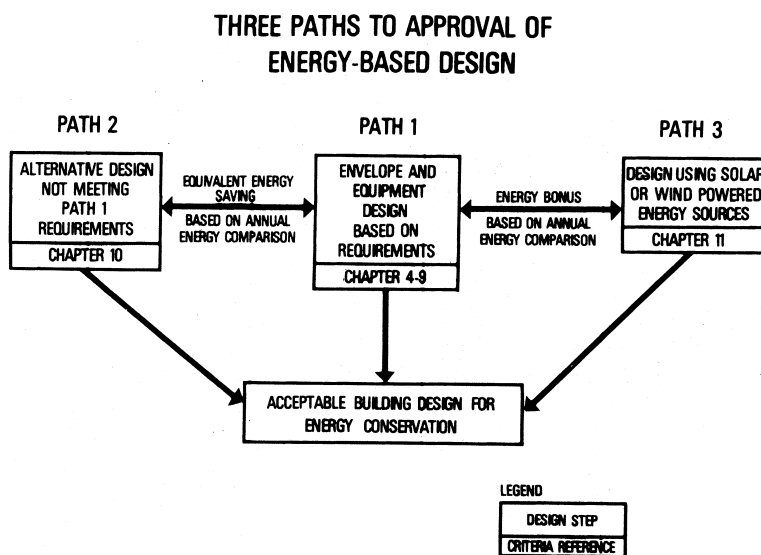

Fig. 1. Three paths to approval of energy-based design.

The energy crisis demanded more sophisticated engineering calculation methods and design, based on quantitative predictions. NBS was ready for the challenge with its background in heat transfer, use of a temperature controlled building shell enclosing a full scale bungalow at the Connecticut Avenue site for measuring efficiency of heating and cooling systems, and the experience of testing and rating heat pumps, including projects *in situ*. At the Gaithersburg site, NBS had state-of-the-art laboratory facilities, including environmental chambers for controlled temperatures from -45°C to 65°C (-50°F to 150°F) with humidity control, as well as outdoor testing facilities, including the Bowman house. Engineering (slide rule) calculations normally consisted of estimating the “steady-state” maximum heating and cooling loads using peak weather data, heat and air transfer calculations, and estimates of imponderables like occupant living patterns, rate of window and door openings, and hot water and appliance usage. When energy was cheap and readily available, this system worked well because equipment could be oversized with factors of safety. What was needed for the high-cost energy crisis was accurate predictions based on measured data, hourly weather data covering all seasons of the year in any location and the dynamic profile of hourly energy required by a proposed building design for a full year. A rapid computer capability was available for computations at NBS; the National Oceanic and Atmospheric Administration could supply hourly weather data for a whole year or for many years for many cities in the United States and globally; and the American Society of Heating, Refrigerating, and Air-Conditioning Engineers (ASHRAE) was rapidly coming up on the learning curve of dynamic computer calculations.

Tamami (Tom) Kusuda at NBS developed a dynamic computer calculation program called the National Bureau of Standards Load Determination Program (NBSLD), described elsewhere in this volume, to address these problems in depth. With availability of a 70,000 cubic foot environmental chamber at NBS, a series of experiments was devised to validate NBSLD using three-dimensional structures whose exteriors could be subjected to dynamic temperature and humidity boundary conditions. The results of experimental validation testing of NBSLD were published in Building Science Series (BSS) 45 in 1973 [6] and in BSS 57 in 1975 [7]. The response factor space load prediction methodology of NBSLD was found to be accurate, and the agreement between calculated and observed heating energy rate was considered excellent. This work had landmark impact because the tools for energy design

and savings procedures were convincingly demonstrated to be reliable.

NBS recommended that its 1974 energy conservation document be used as a basis for development of a national voluntary consensus standard. NCSBCS requested that ASHRAE process the NBS report as a national consensus standard [1]: ASHRAE established an extraordinary effort to analyze and refine the NBS report and, in August 1975, published ASHRAE Standard 90-75 (revised 1977) Energy Conservation in New Building Design, with the technical support of IES (now IESNA).

In January 1977, representatives of NCSBCS and the three model building code organizations put ASHRAE 90-75 into code language under sponsorship of the Energy Research and Development Administration (ERDA) and submitted it to public review and hearings. In December, 1977 the final version was published by the Council of American Building Officials (CABO). Subsequent revisions are known as the Model Energy Code (MEC) [8]. Over the ensuing decade, all 50 states enacted regulations based on the ASHRAE 90 Series Standards, the Model Energy Code, or one of several regional and State codes that also used these ASHRAE Standards as a technical base. ANSI approved a jointly sponsored revision, ANSI/ASHRAE/IES 90A-1980, as an American National Standard [9]. Standard 90A-1980 was a revision of Sections 1-9 of ASHRAE 90-75. An addendum was issued in 1987 to supplement the residential requirements in 90A.

In view of the need for more procedures and data for determining economic efficiency, the NBS/CBT Office of Applied Economics (OAE) addressed the U.S. Department of Energy’s (DOE) Building Energy Performance Standards (BEPS) program—and the need to revise ASHRAE Standard 90 to save more non-renewable energy—with three publications published in 1978-81: *The Role of Economic Analysis in the Development of Energy Standards for New Buildings* [10], A “Reference Building” Approach to Building Energy Performance Standards for Single-Family Residences [11], and *Economics and Energy Conservation in the Design of New Single-Family Housing* [12]. These economic applications to standards for building energy design were based on principles published in 1974 by Stephen R. Petersen in BSS 64 [13] and on OAE Chief Harold E. Marshall’s support of development by ASTM Committees of consensus standards for economic definitions, terms and practices as tools for evaluating energy conserving investments in buildings and building systems [14]. OAE wrote a separate NBSIR report as the basis for each of these ASTM

Standards. These standards have come into use world wide for making both energy and other types of building investment decisions. The economic methods and software initiated with Petersen's work in 1974 and continued to the present have provided the underpinnings of ASTM standard methods universally used for evaluating the economics of energy conservation in buildings.

In 1983-84 the ASHRAE 90 project was reorganized into two project committees, 90.1 covering commercial and high-rise residential buildings and 90.2 covering low-rise residential buildings. A major revision of the commercial building requirements, ASHRAE/IESNA 90.1-1989, was approved by the ASHRAE Board of Directors (BOD) on June 24, 1989 for publication, later updated by seven addenda. ANSI approved ANSI/ASHRAE/IESNA 90.1-1989 with addenda as an American National Standard on July 9, 1996 [15]. In this revision, the complexity and size of the Standard 90 Series was considerably increased by incorporating

building design criteria based on dynamic (e.g., diurnal) heat flow analysis and hourly weather conditions rather than assuming steady-state conditions.

ASHRAE/IES Standard 90.1-1989 for commercial and high-rise residential buildings and the CABO Model Energy Code 1992 for low-rise residential buildings were referenced as minimum requirements in Congressional legislation entitled the Energy Policy Act of 1992 [16]. An energy conservation standard for federal buildings was also developed by DOE under this Public Law and published in DOE regulations, in recognition of different tax laws and economic objectives.

During the 1990s, Standing Standard Project Committee (SSPC) 90.1 maintained the standard by issuing numerous addenda and three public reviews of a major rewrite. The ASHRAE Board of Directors (BOD) voted on June 24, 1999 to approve publication of the revised Standard 90.1-1999 as an ASHRAE/IESNA Standard [17] (Fig. 2), pending ANSI approval of the

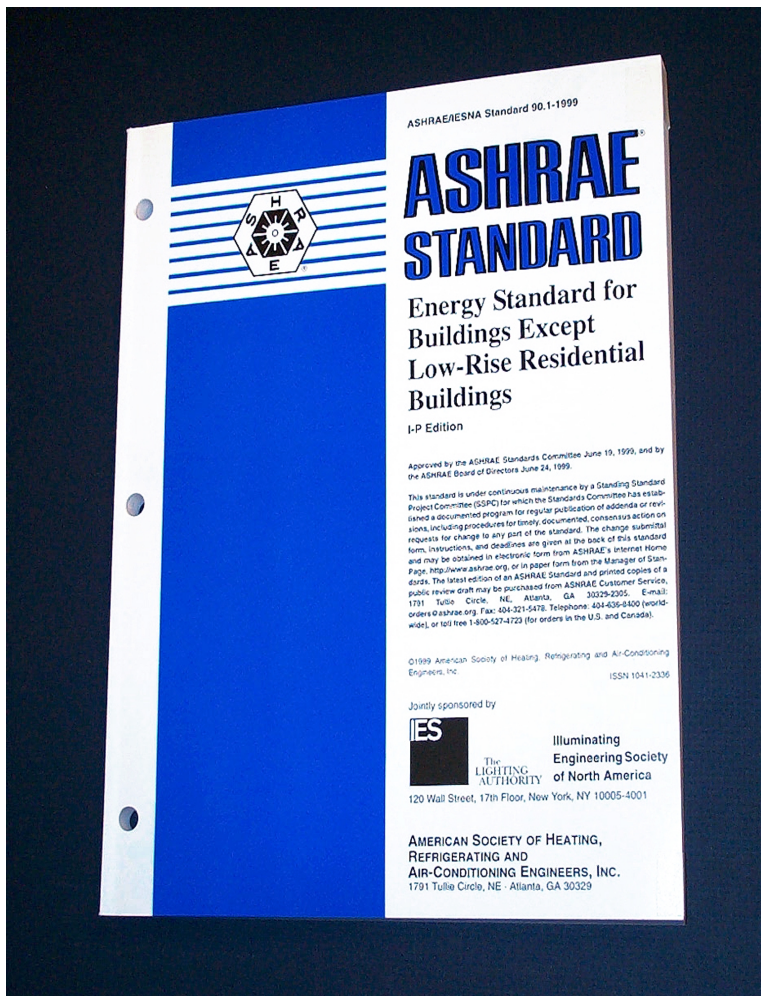

Fig. 2. ASHRAE/IESNA Standard 90.1-1999, *Energy Standard for Buildings Except Low-Rise Residential Buildings*.

revision as an American National Standard. This revision incorporates nine addenda to 90.1-1989, a reorganized document, scope expanded to cover new systems and equipment in existing buildings, code compatible language, and publication in separate IP (inch-pound) and SI versions. More than two-dozen newly proposed addenda were also recommended by the SSPC for public review approval. Over the years, the Standard 90 Series has been the best seller among ASHRAE Standards.

A case study in NISTIR 5840, *Benefits and Costs of Research: Two Case Studies in Building Technology* [18], provided estimates of the economic impacts from past BFRL research leading to the introduction of ASHRAE Standard 90-75—specifically, that portion of the standard dealing with single-family residential energy conservation. The goal of this study was to demonstrate how standardized evaluation methods can be used to evaluate the benefits and costs of research. The energy costs of houses designed according to 90-75 was compared to those of pre-1973 oil embargo standards. More than \$900 million (in 1975 dollars) of the energy savings from 90-75 modifications in single-family houses were directly attributable to BFRL activities that promoted the development of ASHRAE 90-75.

The late Paul R. Achenbach, a mechanical engineer and chief of the Building Environmental Division of the Center for Building Technology, was born in Alberta, Canada. During his 43 year career at NBS, which started in 1937, he pioneered many new developments in the testing, evaluation, and modeling of the performance of building heating and air-conditioning equipment. Many dealt with improving the energy efficiency of this equipment and buildings decades before a concern for energy conservation became widespread. He initiated the programs on energy conservation in buildings and communities at NBS in 1970, for which he received the Department of Commerce Gold Medal in 1975. He had previously received the DOC Silver Medal in 1956 and the NBS Edward B. Rosa Award in 1970 for outstanding achievement in the development of engineering standards.

Throughout his career, Achenbach placed great emphasis on getting his work and that of his staff transferred into practice through the publications, conferences, and standards of ASHRAE. He served on the ASHRAE Board of Directors, and as its Vice President, receiving its Distinguished Service Award; he was named a Fellow and received its highest award for technical achievements, the F. Paul Anderson Award. He served as the Department of Commerce representative on the U.S. National Committee of the International

Institute of Refrigeration (IIR) and was an honorary president of Commission VII of IIR.

Prepared by Jim L. Heldenbrand.

Bibliography

- [1] Jim L. Heldenbrand (ed.), *Design and Evaluation Criteria for Energy Conservation In New Buildings*, NBSIR 74-452, National Bureau of Standards, Washington, DC (1974). Revised in 1976. Includes a February 27, 1974 letter, bound into the document, from F. Karl Willenbrock, Director of the Institute for Applied Technology, NBS, to Bernard E. Cabelus, 1973-74 NCSBCS President.
- [2] Jim L. Heldenbrand, Development and Application of Design Performance Standards for Energy Conservation in Buildings, *Industrialization Forum*, **8** (3), 9-20 (1977) (Ref. p. 9).
- [3] P. R. Achenbach and J. L. Heldenbrand, Development of Performance-Based Energy Conservation Standards for Buildings, in *Proceedings, First Canadian Building Congress: Energy and Buildings*, Toronto, 25 to 27 October 1976, NRCC 15870, Canadian Committee On Building Research of the National Research Council of Canada, Ottawa, Canada (1976) pp. 213-224 (p. 214).
- [4] Delmont C. Thurber, NCSBCS Lifetime Historian, *History of the National Conference of States on Building Codes and Standards, Inc. 1967— . . .*, NCSBCS, Herndon, VA (updated annually). The foreword includes a useful, edited version of early NCSBCS history written by Gene A. Rowland, first NCSBCS President, 1967-68, with comments by Bernard E. Cabelus, NCSBCS President in 1973-74. The main document includes a chronology and narratives of events of the first 20 years, and yearly updates of later NCSBCS conferences.
- [5] Paul R. Achenbach, *Building Research at the National Bureau of Standards*, Building Science Series 0, National Bureau of Standards, Washington, DC, October 1970.
- [6] Bradley A. Peavy, Frank J. Powell, and Douglas M. Burch, *Dynamic Thermal Performance of an Experimental Masonry Building*, Building Science Series 45, National Bureau of Standards, Washington, DC, July 1973.
- [7] B. A. Peavy, D. M. Burch, F. J. Powell, and C. M. Hunt, *Comparison of Measured and Computer-Predicted Thermal Performance of a Four-Bedroom Wood-Frame Townhouse*, Building Science Series 57, National Bureau of Standards, Washington, DC, April 1975.
- [8] Robert Brown and Carolyn Fitch, Introduction to Energy Codes, originally published in *Technical Bulletin*, National Conference of Building Codes and Standards, May 1994, and republished in *Southern Building*, September/October 1994, pp. 29-31 (Ref. p. 30).
- [9] *Energy Conservation In New Building Design*, ANSI/ASHRAE/IES 90A-1980, American Society of Heating, Refrigerating and Air-Conditioning Engineers, Inc., New York, May 16, 1980.
- [10] Stephen R. Petersen, *The Role of Economic Analysis in the Development of Energy Standards for New Buildings*, NBSIR 78-1471, National Bureau of Standards, Washington, DC, May 1978.
- [11] Stephen R. Petersen and Jim L. Heldenbrand, A "Reference Building" Approach to Building Energy Performance Standards for Single-Family Residences, NBSIR 80-2161, National Bureau of Standards, Washington, DC, October 1980.

- [12] Stephen R. Petersen, *Economics and Energy Conservation in the Design of New Single-Family Housing*, NBSIR 81-2380, National Bureau of Standards, Washington, DC, August 1981.
- [13] Stephen R. Petersen, *Retrofitting Existing Housing For Energy Conservation: An Economic Analysis*, Building Science Series 64, National Bureau of Standards, Washington, DC, December 1974. Also, Stephen R. Petersen, *BLCC—The NIST Building Life-Cycle Cost Program*, first software release, 1985, is based on BSS 64.
- [14] *Standard Practice for Measuring Life-Cycle Costs of Buildings and Building Systems*, ASTM E917, American Society for Testing and Materials, West Conshohocken, PA.
- Standard Practice for Measuring Benefit-to-Cost and Savings-to-Investment Ratios for Buildings and Building Systems*, ASTM E964, American Society for Testing and Materials, West Conshohocken, PA.
- Standard Practice for Measuring Internal Rate of Return and Adjusted Internal Rate of Return for Investments In Buildings and Building Systems*, ASTM E1057, American Society for Testing and Materials, West Conshohocken, PA.
- Standard Practice for Measuring Net Benefits for Investments in Buildings and Building Systems*, ASTM E1074, American Society for Testing and Materials, West Conshohocken, PA.
- Standard Practice for Measuring Payback for Investments in Buildings and Building Systems*, ASTM E1121, American Society for Testing and Materials, West Conshohocken, PA.
- Standard Guide for Selecting Economic Methods for Evaluating Investments in Buildings and Building Systems*, ASTM E1185, American Society for Testing and Materials, West Conshohocken, PA.
- [15] *Energy Efficient Design of New Buildings Except Low-Rise Residential Buildings*, ANSI/ASHRAE/IESNA 90.1-1989, American Society of Heating, Refrigerating and Air-Conditioning Engineers, Inc., Atlanta, GA, June 29, 1989; with supplemental addenda approved as an American National Standard on July 9, 1996.
- [16] *Energy Policy Act of 1992*, Public Law 102-486, Title I-Energy Efficiency, Subtitle A-Buildings, Sec. 101. Building energy efficiency standards, October 24, 1992.
- [17] *Energy Standard for Buildings Except Low-Rise Residential Buildings*, ASHRAE/IESNA 90.1-1999, American Society of Heating, Refrigerating and Air-Conditioning Engineers, Inc., Atlanta, GA, June 24, 1999.
- [18] Robert E. Chapman and Sieglinde K. Fuller, *Benefits and Costs of Research: Two Case Studies in Building Technology*, NISTIR 5840, Office of Applied Economics, Building and Fire Research Laboratory, National Institute of Standards and Technology, Gaithersburg, MD, July 1996 (Ref. pp. 47 and 69).

Computer Program for Heating and Cooling Loads in Buildings

In the late 1960s, under the sponsorship of the Department of Housing and Urban Development, Tamami Kusuda began to develop a computer program to help architects and engineers predict the thermal performance of a building. Important enough at the time, this work was to balloon in significance in the context of the energy shortages and rapidly escalating energy prices of the 1970s. The computer program was named the National Bureau of Standards Load Determination (NBSLD) program [1,2]. It combined algorithms for transient conduction in the building

structure, solar heat gains and radiant transfer, and convection between building surfaces and the room air to allow the prediction of temperatures and heating and cooling loads under dynamic conditions. Moreover, the algorithms employed in NBSLD were adopted by the American Society of Heating, Refrigerating and Air-Conditioning Engineers (ASHRAE) as a recommended procedure for computerized energy calculations. They were presented to the Society in a special publication [3] which was sold for many years.

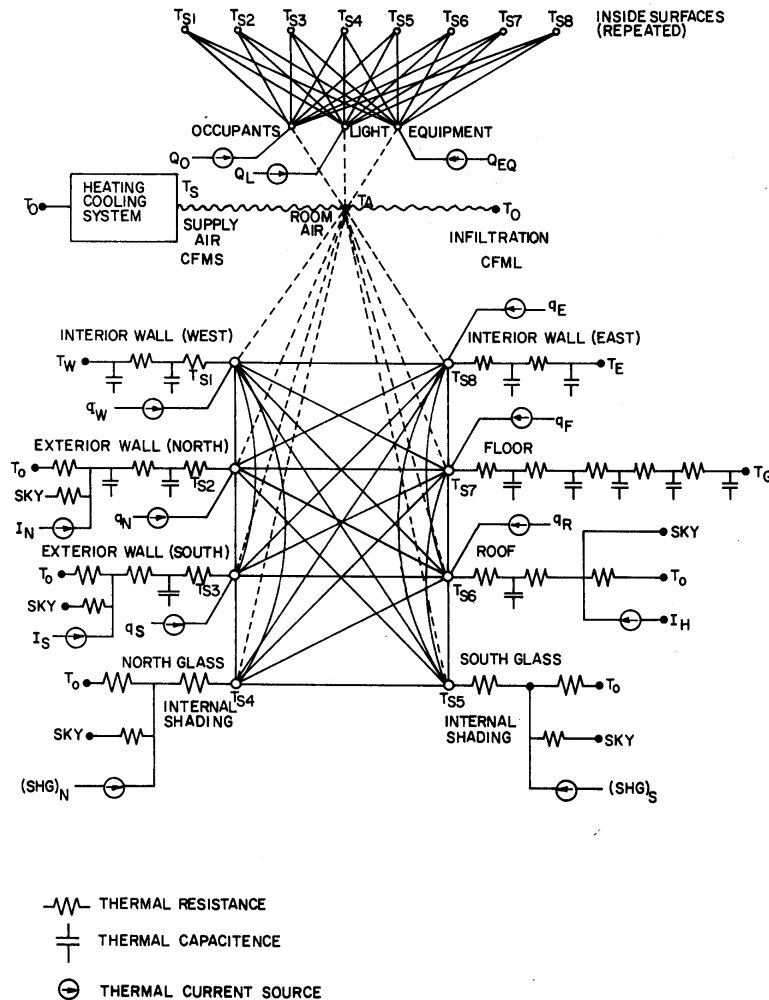

Fig. 1. Analogous electric circuit for heat exchange process in a room.

NBSLD simulated a very simple building model because of the computer limitations of its time. The model included the walls, windows, ceiling, and floor of a single space which might represent a room or an entire building. The user described the geometry of this space, the thermal properties of the building surfaces, optical properties of windows, air infiltration, heat sources such as equipment and occupants, and weather data, including temperature, humidity, and solar radiation values for periods from one day to an entire year. The program converted the building data into the coefficients of a set of simultaneous equations which were solved for temperatures of all the building components as they responded to the internal and external heat sources over time. By fixing the space air temperature to a desired value, the solution of the simultaneous equations gave

the amount of energy that had to be added or removed, i.e., heating or cooling loads, necessary to maintain that temperature.

NBSLD was the result of many years of leadership in this field by Kusuda. His earlier work included development of numerical methods to quickly compute transient conduction through building walls [4] and to determine the thermal properties of moist air [5]. He organized the first three symposia on the Use of Computers for Environmental Engineering Related to Buildings. The first was held at NBS in 1970 [6], the second in Paris in 1974, and the third in Banff, Canada, in 1978. NBSLD was developed with the cooperation of ASHRAE's Task Group on Energy Requirements, in particular the Subcommittee on Heating and Cooling Load Calculations which Kusuda chaired. The members

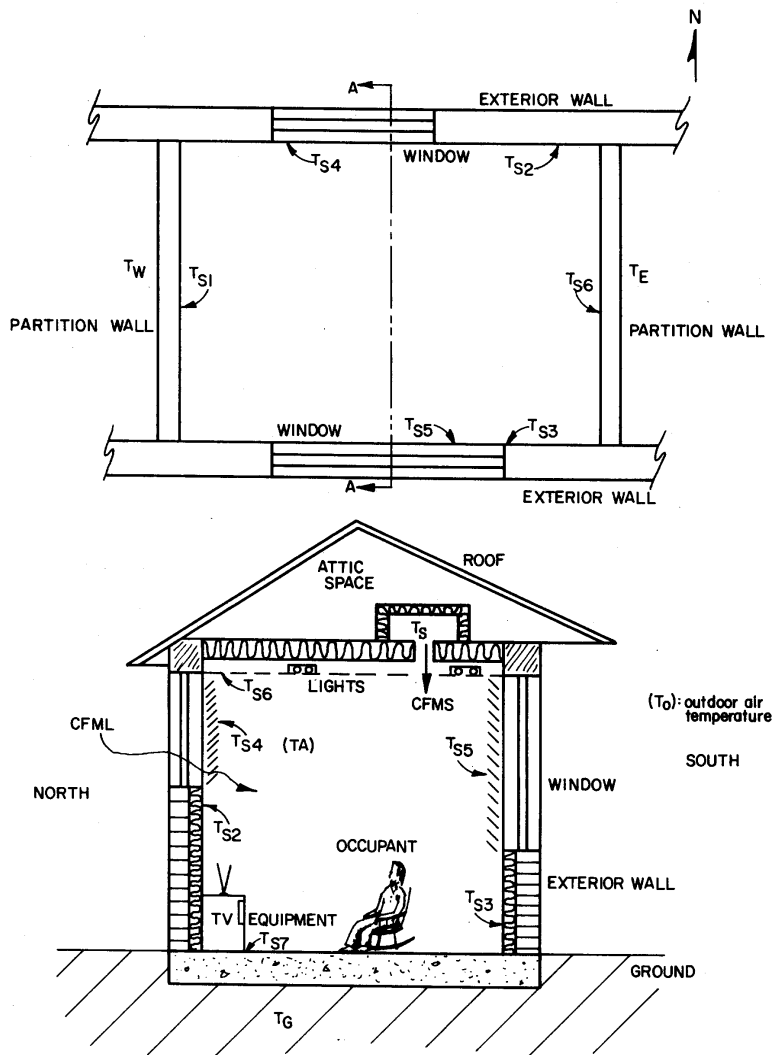

Fig. 2. Physical model of a typical room represented by the circuit in Fig. 1.

of the subcommittee shared their specialized work and computer algorithms. Kusuda developed and implemented the NBSLD framework for putting the algorithms together, and, together with NBS staff, filled in the missing components of the complete model. The Bureau's experimental facilities were used for validation of the program [7,8].

Kusuda's work with the Task Group on Energy Requirements and subsequent technical committees led to his recognition as a fellow of ASHRAE, the society's highest honor. In 1969 the Automated Procedures Engineering Consultants (APEC) awarded Kusuda its first Honorary Membership to recognize his pioneering work on the use of computers for heating, cooling and ventilating engineers.

NBSLD and related research were applied to the energy crisis of the 1970s in the analysis of energy conservation options for specific buildings [9] and in the development of general guidelines [10,11]. Kusuda's work continued in related areas, such as using sunlight in place of electric lighting [12] and studying heat exchange to the ground from buildings and pipes [13]. Recognition for this work includes a Lifetime Achievement Award from the International Building Performance Simulation Association and Silver and Gold Medals from the Department of Commerce.

In addition to the research and energy conservation design done with the NBSLD program, the documentation of its algorithms provided the basis for the development of other building energy simulation programs, both public and private. The algorithms were used almost immediately in the U.S. Army Construction Engineering Research Laboratory's (CERL) first building energy analysis program [14]. In the following years CERL developed new program code to simulate multiple rooms and allow a greater degree of integration of the building loads with the air handling system and plant equipment such as boilers and air conditioners. CERL's BLAST program [15] was released in 1977. The gradual development of multizone airflow calculations has led to a tool [16] for studying indoor air quality and even designing smoke control systems.

At present, the Department of Energy is developing the EnergyPlus program [17], which merges the best features of BLAST and the DOE-2 program. In particular, it is using the heat balance [18] concepts from BLAST which were derived from NBSLD. Because of the need to gather the latest such procedures in a single document, as was originally done by Kusuda, ASHRAE is currently working to provide improved algorithms based on a quarter century of research since the publication of the NBSLD algorithms.

Tamami Kusuda was born in Seattle, Washington. His family returned to Japan before World War II and lived there during the war (and the bombing). He received his B.S. degree from Tokyo University in 1947 and his M.S. and Ph.D. degrees from the University of Minnesota in 1952 and 1955.

Prepared by George Walton.

Bibliography

- [1] Tamami Kusuda, *NBSLD, the Computer Program for Heating and Cooling Loads in Buildings*, Building Science Series 69, National Bureau of Standards, Washington, DC (1976).
- [2] T. Kusuda, *NBSLD, Computer Program for Heating and Cooling Loads in Buildings*, NBSIR 74-574, National Bureau of Standards, Washington, DC (1974).
- [3] ASHRAE Task Group on Energy Requirements, *Procedure for Determining Heating and Cooling Loads for Computerizing Energy Calculations: Algorithms for Building Heat Transfer Subroutines*, American Society of Heating, Refrigerating and Air-Conditioning Engineers, New York (1975).
- [4] T. Kusuda, Thermal Response Factors for Multi-Layer Structures of Various Heat Conduction Systems, *ASHRAE Trans.* **75** (Part 1), 246-271 (1969).
- [5] T. Kusuda, *Algorithms for Psychrometric Calculations, (Skeleton Tables for the Thermodynamic Properties of Moist Air)*, Building Science Series 21, National Bureau of Standards, Washington, DC (1970).
- [6] T. Kusuda (ed.), *Use of Computers for Environmental Engineering Related to Buildings*, Building Science Series 39, National Bureau of Standards, Washington, DC (1971).
- [7] Bradley A. Peavy, Frank J. Powell, and Douglas M. Burch, *Dynamic Thermal Performance of an Experimental Masonry Building*, Building Science Series 45, National Bureau of Standards, Washington, DC (1973).
- [8] B. A. Peavy, D. M. Burch, F. J. Powell, and C. M. Hunt, *Comparison of Measured and Computer-Predicted Thermal Performance of a Four Bedroom Wood-Frame Townhouse*, Building Science Series 57, National Bureau of Standards, Washington, DC (1975).
- [9] Tamami Kusuda, James E. Hill, Stanley T. Liu, James P. Barnett, and John W. Bean, *Pre-Design Analysis of Energy Conservation Options for a Multi-Story Demonstration Office Building*, Building Science Series 78, National Bureau of Standards, Washington, DC (1975).
- [10] G. Kelly, T. Kusuda, and J. Hill, Potential for Energy Conservation in Heating, Ventilating, and Air-conditioning Equipment for Buildings, in *Energy Conservation Through Effective Energy Utilization*, Jesse C. Denton, Stephen Webber, and John Moriarty, (eds.), NBS Special Publication 403, National Bureau of Standards, Washington, DC (1976) pp. 163-191.
- [11] T. Kusuda, Use of Simulation Models of Buildings in Assessing Energy Conservation Strategies, in *Energy Conservation Strategies in Buildings: Comfort, Acceptability, and Health*, Jan A. J. Stolwijk (ed.), John B. Pierce Foundation, New Haven, CT (1978).

- [12] T. Kusuda and J. W. Bean, Comparison Between a Simplified Daylighting Calculation Procedure and a Comprehensive Inter-reflection Model Calculation Procedure, in *Proceedings of the Third International Symposium on the Use of Computers for Environmental Engineering Related to Buildings*, Alberta, Canada, CNRC Publ. 17376, National Research Council of Canada, Ottawa, Canada (1978).
- [13] T. Kusuda, M. Mizuno, and J. W. Bean, *Seasonal Heat Loss Calculation for Slab-on-Grade Floors*, NBSIR 81-2420, National Bureau of Standards, Washington, DC (1982).
- [14] D. Hittle and B. Sliwinski, *CERL Thermal Loads Analysis and Systems Simulation Program Volume 2: Program Reference Manual*, CERL Interim Report E-81, US Army Construction Engineering Research Laboratory, Champaign, Illinois (1975).
- [15] D. C. Hittle, *The Building Loads Analysis and System Thermodynamics (BLAST) Program*, CERL Technical Report E-119, US Army Construction Engineering Research Laboratory, Champaign, Illinois (1977).
- [16] George N. Walton, *CONTAM96 User Manual*, NISTIR 6056, National Institute of Standards and Technology, Gaithersburg, MD (1997).
- [17] D. B. Crawley, L. K. Lawrie, C. O. Pedersen, R. J. Liesen, D. E. Fisher, R. K. Strand, R. D. Taylor, F. C. Winkelmann, W. F. Buhl, A. E. Erdem, and Y. J. Huang, EnergyPlus: A New-Generation Building Energy Simulation Program, in *Building Simulation '99*, Volume I, Kyoto, Japan, International Building Performance Simulation Association (1999) pp. 81-88.
- [18] R. Strand, F. Winkelmann, F. Buhl, J. Huang, R. Liesen, C. Pedersen, D. Fisher, R. Taylor, D. Crawley, and L. Lawrie, EnergyPlus: Enhancing and Extending the Capabilities of the Building Heat Balance Simulation Technique for Use in Energy-Plus, in *Building Simulation '99*, Volume I, September 1999, Kyoto, Japan, International Building Performance Simulation Association (1999) pp. 653-660.

Methods for Testing and Rating the Performance of Heating and Air Conditioning Systems

The U.S. Congress enacted the Energy Policy and Conservation Act (EPCA, Public Law 94-163) in December 1975. It was subsequently amended four times, most recently in 1992. As amended, EPCA requires:

- the U.S. Department of Energy (DOE) to establish energy conservation standards (minimum efficiency or maximum energy use) for all major energy consuming products in a residence,
- the National Bureau of Standards (NBS) to develop test procedures for the same products, and
- the U.S. Federal Trade Commission (FTC) to develop a program of labeling the products to encourage purchase of energy efficient equipment.

EPCA required NBS to develop test procedures for each product for the determination of estimated annual operating cost and at least one other useful measure of energy consumption likely to assist consumers in making purchasing decisions. An additional requirement of the law was that “any test procedures prescribed be reasonably designed to produce test results which reflect energy efficiency, energy use, or estimated annual operating cost during a representative average use cycle and not be unduly burdensome to conduct.”

Beginning in 1975, NBS staff reviewed the test procedures already in use within the appliance and heating and cooling industry. By the early 1980s, test procedures were in place for all covered products. Throughout the development, NBS staff worked closely with industry representatives experienced in testing the equipment to obtain their review and recommendations, particularly on energy conservation innovations that were being considered for future products.

This review found many test procedures that could be used with minor modifications and recommended them for adoption. The industry procedures that required little change were primarily for “white” appliances, those used for cooking, cleaning, refrigerating food, etc. For them, the performance and annual cost of operation were primarily dependent on the use schedule. Therefore, NBS adopted steady-state tests plus a calculation procedure assuming a specific daily operating schedule.

In the case of residential heating and cooling systems, however, entirely new procedures had to be developed, as described in these publications [1,2]. At the time, steady-state tests were used in the industry for central heating and cooling equipment. However, the equipment cycled on and off frequently throughout most days. During the start-up and shut-down periods, most of the equipment experienced non-trivial energy losses or inefficiencies associated with warm-up, cool-down, and/or migration of refrigerant. In addition, the performance of this equipment was almost independent of the user (except for thermostat setting) and primarily dependent on the weather conditions. As a result, NBS staff developed new procedures for this type of equipment that included steady-state and cycling tests coupled with a calculation procedure that accounted for the changing weather conditions throughout the heating and cooling seasons.

Kelly and Chi published the initial procedure for central furnaces and boilers in 1978 [1]. The testing required was simple, but the estimation of yearly performance was done through an elaborate calculation procedure. They found that the performance of furnaces and boilers under part-load, on-off operation could be described by a simple “time-constant” model, and that data required to determine the time-constant could be obtained during “warm-up” and “cool-down” periods before and after a steady-state test without extensive cycling tests.

Based on the test data, five major loss terms were calculated and subtracted from 100 to obtain the value of the seasonal efficiency.

1. Latent Heat Loss, due to the presence of uncondensed water vapor in the flue gas.
2. On-Period Sensible Heat Loss, due to the heating of combustion products and excess air from room temperature up to the flue gas temperature.
3. On-Period Infiltration Loss, due to heating on-cycle combustion and relief air from the outdoor temperature up to room temperature.
4. Off-Period Sensible Heat Loss, due to the heating of the off-cycle draft air up to a temperature in excess of the indoor air temperature.

5. Off-Period Infiltration Loss, due to the heating of the off-cycle draft and relief air from the outdoor up to the indoor air temperature.

In developing the calculation procedure, Kelly and Chi found that they could evaluate the loss terms at the heating season average outdoor air temperature and obtain virtually identical results with a more complicated “bin” analysis with a separate calculation of efficiency for each “bin.” In addition, the manufacturer had to calculate an annual fuel utilization efficiency (AFUE) which differed from the seasonal efficiency if there was consumption of energy by a pilot light operating during the non-heating season.

After the publication of the original test procedure, Kelly and his colleagues modified it to handle advances in furnace and boiler technology such as:

1. pulse combustion and condensing furnaces [6]
2. modulating and two-step controls on furnaces and boilers [7]
3. furnaces with inlet dampers [8]
4. furnaces with post purge design [9].

Didion and Kelly [2] used the same approach in developing the test and calculation procedure for central air conditioners and heat pumps as for furnaces and boilers. However, because of the different ways refrigerant migrated from one component to another during

the off-cycle, they could not describe the performance during the off-cycle by a simple time constant model. As a result, the testing procedure was considerably more complicated and required cycling tests.

The tests for central air conditioners and heat pumps operating in the cooling mode consisted of three steady-state tests and one cycling test. In all tests, the capacity, electrical energy input, and coefficient of performance (COP) were determined. Didion and Kelly expected to develop a procedure with only two tests: one at full capacity and one at some part-load condition requiring the unit to cycle. In both tests, the indoor coil would be wet with dehumidification occurring. However, in preliminary studies, they found that a wet-coil cycling test at part-load conditions presented significant experimental problems. The capacity was determined by measuring the enthalpy increase across the indoor coil. This measurement was unreliable under periodically varying conditions. Fortunately, they found that the ratio of the COP in the cycling mode to that under steady-state conditions was the same for dry-coil and wet-coil conditions for the same part-load conditions. Consequently, two tests were conducted to determine a degradation coefficient describing the losses due to cycling under dry-coil conditions. These results were used to modify a wet-coil steady-state test where the unit would normally cycle. Manufacturers could use an assumed value of the degradation coefficient in lieu of conducting the two dry coil tests. Finally, a full-load steady-state test was conducted at a hot outdoor temperature.

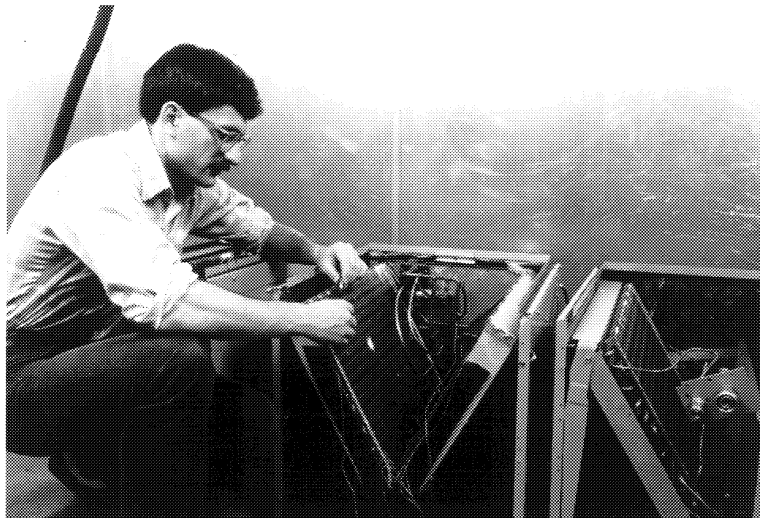

Fig. 1. Maciej Chwalowski prepares central air conditioning units for test.

As with furnaces and boilers, Didion and Kelly intended to use a bin method for calculating a seasonal energy efficiency ratio (SEER), where the performance was weighted by the number of hours the unit operates in each temperature bin. Again, they found the variation in SEER with climate for typical units to be only slight. Consequently, the SEER was calculated for a climate with a specific average operating outdoor temperature.

Four tests were also required for heat pumps operating in the heating mode: a full load steady-state test at a high outdoor temperature and one at a low temperature to determine how the capacity and power varied with temperature differences; a third test to determine cycling degradation; and a fourth to determine the effect of frosting on the outdoor coil. The calculation procedure to obtain a heating season performance factor (HSPF) was a bin method. They were not able to find a short-cut procedure as with furnaces and boilers and air conditioners operating in the cooling mode.

After the publication of the original test procedure, Didion and his colleagues modified it to handle variable-speed equipment [10]. This increased the number of mandatory tests to ten and optional tests to five. In addition, they developed procedures to rate mixed systems: those where the indoor coil of one tested system is installed with the outdoor compressor-condenser unit of another tested system [11,12].

The development of the new test procedures for central heating and cooling caused a revolution in the way industry tested such equipment. They resisted and fought the changes for several years because of the

increased cost and complexity of testing. Ultimately the tests were accepted, used throughout the industry, and adopted by the American Society of Heating, Refrigerating, and Air-Conditioning Engineers (ASHRAE) as ASHRAE Standards 103 (Central Furnaces and Boilers) and 116 (Unitary Air Conditioners and Heat Pumps).

Residential equipment accounted for 20 % of U.S. national energy consumption during the last quarter of the 20th century. The development of these test procedures, a labeling program for some of the equipment, and the threat of mandatory standards resulted in substantial increases in U.S. equipment efficiency. The American Council for an Energy Efficient Economy (ACEEE) [13] reported average efficiency increases from 1972 to 1987 of 96 % for refrigerator-freezers, 35 % for central air conditioners and heat pumps, 30 % for room air conditioners, and 18 % for gas furnaces.

George E. Kelly came to NBS in 1970 as a National Research Council/NBS Postdoctoral Research Associate. For two years, he conducted research on condensation and the theory of droplet growth in homogeneous nucleation. He joined the predecessor organization of the Building and Fire Research Laboratory (BFRL) in 1972 and began immediately working on the program of testing heating and cooling equipment for seasonal performance described above. Because of its significant impact, George received the Department of Commerce Silver Medal in 1978. He went on to establish a significant new research program on building controls beginning in 1980. Over a period of 20 years, he and his staff gained a world-wide reputation for their work. They developed an advanced dynamic building/HVAC

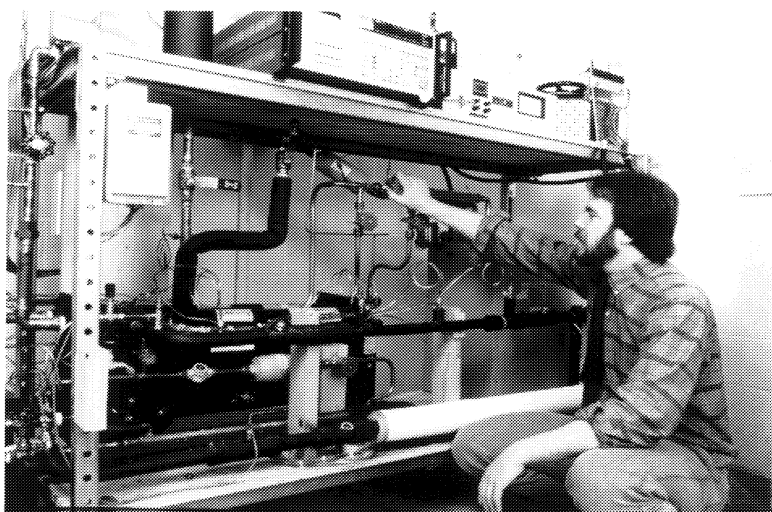

Fig. 2. David Aaron adjusts flow conditions in refrigeration loop where flow restrictors are evaluated.



Fig. 3. Brian Dougherty prepares super-efficient heat pump for tests.

control simulation program HVACSIM+, pioneered an innovative method for testing and evaluating computerized control systems using a building emulator, and developed a standard communication protocol for building controls, BACnet, which was adopted nationally as ASHRAE Standard 135, adopted internationally by ISO, and named by Engineering News Record in 1999 as one of the 100 top innovations of the 20th century in the construction industry. For his work, George was named the Department of Commerce Engineer of the Year in 1992. He was promoted to Chief of the Building Environment Division of BFRL in 1999.

David A. Didion came to NBS in 1971 and immediately began working on the performance of heating and cooling equipment. He too received the Department of Commerce Silver Medal in 1981 for his work. In 1980, Dave and his staff began an intense research program on refrigeration machinery and the use of refrigerant mixtures to improve their performance. When ozone depletion in the stratosphere was recognized as an international environmental crisis and the first international protocol/regulation was established in 1987, chlorofluorocarbons (CFC) were phased out of use in refrigeration equipment. Dave's research team was ideally poised to lead the national effort in identifying

refrigerant mixtures that ultimately replaced the CFCs. For this work he was recognized with numerous awards; among them the Department of Commerce Gold Medal (1987), the NIST Applied Research Award (1987), the Edward Uhler Condon Award (1988), the William P. Slichter Award (1995), and the first Gustav Lorenzen Prize from the International Institute of Refrigeration (1999). He was elevated to NIST Fellow in 1995.

Prepared by James E. Hill.

Bibliography

- [1] Joseph Chi and George E. Kelly, A Method for Estimating the Seasonal Performance of Residential Gas and Oil-Fired Heating Systems, *ASHRAE Trans.* **84**, Part 1, 405-421 (1978).
- [2] David A. Didion and George E. Kelly, New Testing and Rating Procedures for Seasonal Performance of Heat Pumps, *ASHRAE J.* **21** (9), 40-44 (1979).
- [3] George E. Kelly, Joseph Chi and Mark E. Kuklewicz, *Recommended Testing and Calculation Procedures for Determining the Seasonal Performance of Residential Central Furnaces and Boilers*, NBSIR 78-1543, National Bureau of Standards, Washington, DC, September 1978.
- [4] G. E. Kelly and W. H. Parken, Jr., *Method of Testing, Rating, and Estimating the Seasonal Performance of Central Air-Conditioners and Heat Pumps Operating in the Cooling Mode*, NBSIR 77-1271, National Bureau of Standards, Washington, DC, April 1978.
- [5] Walter H. Parken, George E. Kelly, and David A. Didion, *Method of Testing, Rating, and Estimating the Heating Seasonal Performance of Heat Pumps*, NBSIR 80-2002, National Bureau of Standards, Washington, DC, April 1980.
- [6] George E. Kelly and Mark E. Kuklewicz, *Recommended Testing and Calculation Procedures for Estimating the Seasonal Performance of Residential Condensing Furnaces and Boilers*, NBSIR 80-2110, National Bureau of Standards, Washington, DC, April 1981.
- [7] Esher Kwellner and Robert L. Palla, Jr., *A Test Method and Calculation Procedure for Determining Annual Efficiency for Vented Household Heaters and Furnaces Equipped with Modulating-Type Controls*, NBSIR 82-2497, National Bureau of Standards, Washington, DC, May 1982.
- [8] Stanley T. Liu, George E. Kelly, and Charles P. Terlizzi, *Testing and Rating of an Atmospheric, Gas-Fired Furnace Equipped with a Burner Air Inlet Damper*, NISTIR 4717, National Institute of Standards and Technology, Gaithersburg, MD, November 1991.
- [9] Stanley T. Liu, George E. Kelly, and Charles P. Terlizzi, *Evaluating the Off-Cycle Losses of a Gas-Fired, Power Vented Furnace Employing Post Purge*, NISTIR 4908, National Institute of Standards and Technology, Gaithersburg, MD, August 1992.
- [10] Piotr A. Domanski, *Recommended Procedure for Rating and Testing of Variable Speed Air Source Unitary Air Conditioners and Heat Pumps*, NISTIR 88-3781, National Institute of Standards and Technology, Gaithersburg, MD, May 1988.
- [11] Piotr A. Domanski, *Rating Procedure for Mixed Air-Source Unitary Air Conditioners and Heat Pumps Operating in the Cooling Mode—Revision 1*, NISTIR 89-4071, National Institute of Standards and Technology, Gaithersburg, MD, May 1989.
- [12] Piotr A. Domanski, *Rating Procedure for Mixed Air-Source Unitary Heat Pumps Operating in the Heating Mode*, NISTIR 90-4298, National Institute of Standards and Technology, Gaithersburg, MD, May 1990.
- [13] Howard S. Geller, *Residential Equipment Efficiency: 1988 Update*, American Council for an Energy-Efficient Economy, Washington, DC, August 1988.

System for Fire Safety Evaluation of Health Care Facilities

The Fire Safety Evaluation System (FSES) for Health Care Facilities [1] was the first of a series of FSES documents covering a variety of types of occupancies including apartment buildings [2], prisons and jails [3], office and laboratory buildings [4], overnight accommodations in National Parks [5], and board and care facilities [6]. These have provided means for meeting or exceeding the level of safety prescribed by the applicable code while providing the designer with a wide range of cost saving and functional options.

The FSES's have been adopted into building codes and similar regulations and have been institutionalized by the establishment of a special technical committee of the National Fire Protection Association (NFPA) charged with the responsibility for Alternative Methods for Life Safety in Buildings. This committee maintains NFPA Standard 101A [8] in support of the FSES's, thereby ensuring that each FSES remains current and an appropriate reflection of the changing safety levels prescribed by building codes and regulations. This description, however, focuses on the FSES for Health Care Facilities, as a representative sample of the complete series.

The FSES for Health Care Facilities was part of a broad fire safety effort sponsored by the Department of Health and Human Service in response to an important need to develop a means for meeting the fire safety objectives of prescribed codes without necessarily being in explicit compliance with the code. In the 1960s, with the birth of the Medicare and Medicaid programs, Congress prescribed conformance with the requirements of the Life Safety Code, National Fire Protection Association Standard 101, in all nursing homes and hospitals receiving funds under those programs. A nation-wide inspection and enforcement program was established to ensure compliance. Most, if not all, inspected facilities were found to be in some degree of non-compliance with the specific requirements of the Life Safety Code. A significant number were closed as a result. Others undertook correction programs. Many, including some of the Nation's largest and most prestigious hospitals, were declared to fail this safety standard.

The FSES for Health Care Facilities was developed to discover alternate solutions, delivering at least an equivalent level of safety as compared to that produced by exact compliance with the detailed prescriptions of the Life Safety Code. In the case of one large hospital

complex, the use of the FSES reduced the cost of compliance from an estimated \$30 million to \$60 million to less than \$2 million. Equally important, the development of alternative approaches allowed the improvements to be made without interruption of hospital services.

The FSES is a grading system designed to determine the overall level of fire safety of an existing or proposed facility in comparison with a hypothetical facility that exactly matched each requirement of the Life Safety Code. The enclosed figure shows Table 4 and 5 of the FSES for Health Care Facilities. These two tables are the most critical to the evaluation. These tables describe most of the universe of common building factors that determine fire safety, such as type of construction, partitioning and finishes, hazardous activities, fire detection and suppression, and fire alarm systems. For practical considerations, however, factors relating to building utilities, furniture, and emergency procedures are handled elsewhere in the FSES.

The levels of parameter values in Table 4 represent the levels of performance that exist in the real world of health care facilities. Some are those required by the code, while others have either more or less impact on safety than the code requirements.

The values assigned to each level are dimensionless, developed through consensus and designed to be comparative in relative value in both the evaluation of the levels within a parameter and between parameters. The specific values for each element in a parameter were developed by iteration through three separate Delphi panels. The base scale of measurement was established by these panels with the directive that the most powerful safeguard was assigned a score of 10, and an element that neither added to or detracted from safety was score 0. Using this scale, all other elements were scored with negative numbers representing an element detrimental to life safety and positive numbers representing elements additive to life safety.

Computer analysis was used to evaluate all possible permutations. The overall safety of the resulting solutions was then evaluated by the Delphi groups. The iterative process of adjusting parameter element values and appraising the resultant level of safety continued until all of the panels concurred that all solutions indicating a level of fire safety that equaled or exceeded the level provided by rigid conformance with the letter of the code did deliver that indicated level of safety.

TABLE 4. SAFETY PARAMETERS VALUES

PARAMETERS	PARAMETERS VALUES						
	COMBUSTIBLE				NONCOMBUSTIBLE		
1 CONSTRUCTION	WOOD FRAME		ORDINARY		NONCOMBUSTIBLE		
FLOOR OR ZONE	UNPROTECTED	PROTECTED	UNPROTECTED	PROTECTED	UNPROTECTED	PROTECTED	FIRE RESIST.
FIRST	-2	0	-2	0	0	2	2
SECOND	-7	-2	-4	-2	-2	2	4
THIRD	-9	-7	-9	-7	-7	2	4
4 TH & ABOVE	-13	-7	-13	-7	-9	-7	4
2 INTERIOR FINISH (Corr. & Exit)	CLASS C		CLASS B		CLASS A		
	-5		0		3		
3 INTERIOR FINISH (Rooms)	CLASS C		CLASS B		CLASS A		
	-3		1		3		
4 CORRIDOR PARTITIONS/WALLS	NONE OR INCOMPLETE -10(0)*	<1/2 HR 0	≥1/2 TO 1 HR 1(0)*	≥1HR 2(0)*			
5 DOORS TO CORRIDORS	NO DOOR -10	<20 MIN FR 0	≥20 MIN FR 1(0)††	≥20 MIN FR AND AUTO CLOS. 2(0)†††			
6 ZONE DIMENSIONS	DEAD END MORE THAN 100 -6(0)**		DEAD END 30 – 100 -4(0)**		NO DEAD ENDS >30 & ZONE LENGTH IS		
					>150 -2	100 – 150 0	<100 1
7 VERTICAL OPENINGS	OPEN 4 OR MORE FLOORS -14		OPEN 2 OR 3 FLOORS -10		ENCLOSED WITH INDICATED FIRE RESIST.		
					<1 HR 0	≥1 HR – 2 HR -2(0)†	>2 HR 3(0)†
8 HAZARDOUS AREAS	DOUBLE DEFICIENCY		SINGLE DEFICIENCY		NO DEFICIENCIES		
	IN ZONE -11	OUTSIDE ZONE -5	IN ZONE -6	OUTSIDE ZONE -2	0		
9 SMOKE CONTROL	NO CONTROL -5(0)***	SMOKE PARTITIONS 0		MECH. ASSISTED SYSTEMS			
				BY ZONE 3	BY CORRIDOR 4		
10 EMERGENCY MOVEMENT ROUTES	<2 ROUTES -8	MULTIPLE ROUTES					
	DEFICIENT CAPACITY -2	W/O HORIZONTAL EXITS 0		HORIZONTAL EXITS 3		DIRECT EXITS 5	
11 MANUAL FIRE ALARM	NO MANUAL FIRE ALARM -4		MANUAL FIRE ALARM				
			W/O F.D. CONN. 1		W.F.D. CONN. 2		
12 SMOKE DETECTION & ALARM	NONE 0	CORRIDOR ONLY 2		ROOMS ONLY 3	CORRIDOR & HABIT. SPACE 4		TOTAL ZONE 5
13 AUTOMATIC SPRINKLERS	NONE 0	CORRIDOR 2(0)††	CORRIDOR & HABIT. SPACE 8		TOTAL BLDG 10		

NOTE * Use 0 when item 5 is -10
 ** Use 0 when item 10 is -8
 *** Use 0 on zone with less than 31 patients in existing buildings

† Use 0 when item 1 is based on first floor zone or on an unprotected type of construction
 †† Use 0 when item 1 is based on an unprotected type of construction
 ††† Use 0 when item 4 is -10

Fig. 1a. Illustration of the FSES rating system (Part 1).

The parameter values established in Table 4 are transferred to Table 5. Table 5 evaluates the importance of each parameter to the fire safety sub-objectives of fire containment, extinguishment, and people movement. This approach avoids the overdependence on any single parameter and ensures a degree of redundancy as expected as part of the overall fire safety of a facility.

The scoring derived from Table 5 is compared with the score developed by the previously mentioned hypothetical facility. If the score of the facility under evaluation equals or exceeds that of the hypothetical facility in all sub-objectives, the facility is deemed to be in conformance with the objectives of the Life Safety Code.

The validity of the FSES rests primarily on:

- the completeness of the universe of parameters and parameter factors in Table 4;
- the appropriateness of the relative parameter values assigned in Table 4; and
- the relationships established in Table 5.

The details of how this validity was achieved are contained in reference [1]. An informative discussion of the relevance of the approach to validity is available in Nelson's paper *An Approach to Enhancing the Value of Professional Judgement in the Determination of Performance Criteria* [7].

TABLE 5. INDIVIDUAL SAFETY EVALUATIONS

SAFETY PARAMETERS	CONTAINMENT SAFETY (S ₁)	EXTINGUISHMENT SAFETY (S ₂)	PEOPLE MOVEMENT SAFETY (S ₃)	GENERAL SAFETY (S _G)
1. CONSTRUCTION				
2. INTERIOR FINISH (Corr. & Exit)				
3. INTERIOR FINISH (Rooms)				
4. CORRIDOR PARTITIONS/WALLS				
5. DOORS TO CORRIDOR				
6. ZONE DIMENSIONS				
7. VERTICAL OPENINGS				
8. HAZARDOUS AREAS				
9. SMOKE CONTROL				
10. EMERGENCY MOVEMENT ROUTES				
11. MANUAL FIRE ALARM				
12. SMOKE DETECTION & ALARM				
13. AUTOMATIC SPRINKLERS			÷ 2 =	
TOTAL VALUE	S ₁ =	S ₂ =	S ₃ =	S _G =

Fig. 1b. Illustration of the FSES rating system (Part 2).

The FSES for Health Care Facilities was adopted by the National Fire Protection Association as part of the 1981 edition of the Life Safety Code. It provided a recognized means of developing alternative approaches to determine compliance with the code in that and later editions of the Life Safety Code.

Subsequently, the Life Safety Code adopted FSES's developed by NBS/NIST covering Detention and Correctional Occupancies (i.e., prisons and jails), Board and Care Occupancies, and Office Occupancies. In 1995 the National Fire Protection Association created a new document NFPA 101A, *Guide on Alternative*

Approaches to Life Safety [8] to gather and contain the FSES's in a single publication and place them in the care of a single technical committee. Harold Nelson was the initial chair of this committee, and upon his retirement the chair was given to David Stroup, also of NIST.

The FSES's have stood the test of time and are now a regular part of life safety design in many buildings. They have both improved safety and reduced costs. In the NIST study *Benefits and Costs of Research: A Case Study of the Fire Safety Evaluation System* by Chapman and Weber [9], an estimated savings of almost \$1 billion up to 1995 was credited to the FSES for Health Care Facilities. Unmeasured but significant savings have also been achieved by the other FSES's.

In the early 1980's Chapman and his colleagues [10] extended the work of Nelson's team by the development of a cost optimizer computer program enabling the

user to determine the best cost acceptable alternatives to achieving equivalent safety with the Life Safety Code requirements for Health Care Facilities. In 1994 this work was used to develop the computer program *ALARM 1.0, Decision Support Software for Cost-Effective Compliance with Fire Safety Codes* [11].

Nelson retired from NIST in 1992 but continues actively as a consultant in fire safety matters. Nelson's honors include the Department of Commerce Silver and Gold Medals; Federal Research Laboratory Consortium Special Award for Technology Transfer; Society of Fire Protection Engineers, Harold E. Nelson Professional Service Award (inaugural awardee); Standards Medal of the National Fire Protection Association; and the Kawaoe Metal of the International Association for Fire Safety Science for lifetime contributions to fire safety science.



Fig. 2. Harold Nelson.

In the long term, the principal importance of the fire safety evaluation systems lies not only in the specific objective of delivering safety with lower cost and greater design flexibility, but also in the demonstration that a total performance approach to fire safety is feasible.

Prepared by Harold Nelson.

Bibliography

- [1] H. E. Nelson and A. J. Shibe, *A System for Fire Safety Evaluation of Health Care Facilities*, NBSIR 78-1555-1, National Bureau of Standards, Washington, DC (1978).
- [2] H. E. Nelson and A. J. Shibe, *A System for Fire Safety Evaluation for Multifamily Housing*, NBSIR 82-2562, National Bureau of Standards, Washington, DC (1982).
- [3] H. E. Nelson and A. J. Shibe, *The Development of a Fire Evaluation System for Detention and Correctional Occupancies*, NBSIR 84-2976, National Bureau of Standards, Washington, DC (1984).
- [4] H. E. Nelson, *Fire Safety Evaluation System for NASA Office/Laboratory Buildings*, NBSIR 86-3404, National Bureau of Standards, Gaithersburg, MD (1986).
- [5] H. E. Nelson, A. J. Shibe, B. M. Levin, S. D. Thorne, and L. Y. Cooper, *Fire Safety Evaluation System for National Park Service Overnight Accommodations*, NBSIR 84-2896, National Bureau of Standards, Washington, DC (1984).
- [6] H. E. Nelson, B. M. Levin, A. J. Shibe, N. E. Groner, R. L. Paulsen, D. M. Alvord, and S. D. Thorne, *A Fire Safety Evaluation System for Board and Care Homes, Final Report*, NBSIR 83-2659, National Bureau of Standards, Washington, DC (1983).
- [7] H. E. Nelson, An Approach to Enhancing the Value of Professional Judgement in the Derivation of Performance Criteria, in *Proceedings of the 3rd ASTM/CIB/RELIM Symposium on the Performance Concept in Buildings*, Lisbon, March 29–April 2, 1982.
- [8] *Guide on Alternative Approaches to Life Safety*, ANSI/NFPA 101A-1998, National Fire Protection Association, Quincy, MA (1998).
- [9] Robert E. Chapman and Stephen F. Weber, *Benefits and Costs of Research: A Case Study of the Fire Safety Evaluation System*, NISTIR 5863, National Institute of Standards and Technology, Gaithersburg, MD (1996).
- [10] Robert E. Chapman, *A Cost-Conscious Guide to Fire Safety in Health Care Facilities*, NBSIR 82-2600, National Bureau of Standards, Washington, DC (1982).
- [11] S. F. Weber and B. C. Lippiatt, *ALARM 1.0—Decision Support Software for Cost-Effective Compliance with Fire Safety Codes*, NISTIR 5554, National Institute of Standards and Technology, Gaithersburg, MD (1994).

Estimation of Rate of Heat Release by Means of Oxygen Consumption Measurements

Intuitively, the rate of heat release from an unwanted fire is a major indication of the threat of the fire to life and property. This is indeed true, and a reliable measurement of a fire's heat release rate was a goal of fire researchers at NBS and other fire laboratories at least as early as the 1960s. Historically, heat release measurements of burning materials were based on the temperature rise of ambient air as it passed over the burning object. Because the fraction of heat released by radiant emission varies with the type of material being burned, and because not all the radiant energy contributes to temperature rise of the air, there were large errors in the measurements. Attempts to account for the heat that was not captured by the air required siting numerous thermal sensors about the fire to intercept and detect the additional heat. This approach proved to be tedious, expensive, and susceptible to large errors, particularly when the burning "object" was large, such as a full-sized room filled with flammable furnishings and surface finishes.

A novel alternative technique for determining heat release rate was developed at NBS during the 1970s. It had distinct advantages over the customary approach, but its widespread acceptance was hampered by uneasiness in the fire science community concerning potential errors if the technique were used in less-than-ideal circumstances. In 1980 Clayton Huggett, a fire scientist at NBS, published the seminal paper [1] that convinced the fire science community that the new technique was scientifically sound and sufficiently accurate for fire research and testing. The technique is now used worldwide and forms the basis for several national and international standards.

The underlying principle of the new heat release rate technique was "discovered" in the early 1970s. Faced with the challenge of measuring the heat release of combustible wall linings during full-scale room fire tests, William Parker, Huggett's colleague at NBS, investigated an alternative approach based on a simple fact of physics: in addition to the release of heat, the combustion process consumes oxygen. As part of his work on the ASTM E 84 tunnel test, Parker [2] explored the possibility of using a measurement of the reduction of oxygen in fire exhaust gases as an indicator of the amount of heat released by the burning test specimens. Indeed, for well-defined materials with known chemical composition, heat release and oxygen consumption can

both be calculated from thermodynamic data. The problem with applying this approach to fires is that in most cases the chemical compositions of modern materials/composites/mixes that are likely to be involved in real fires are not known. In the process of examining data for complete combustion (combustion under stoichiometric or excess air conditions) of the polymeric materials with which he was working, Parker found that, although the heat released per unit mass of material consumed (i.e., the specific heat of combustion), varied greatly, the amount of heat released per unit volume of oxygen consumed was fairly constant, i.e., within 15 % of the value for methane, 16.4 MJ/m³ of oxygen consumed.

This fortunate circumstance—that the heat release rate per unit volume of oxygen consumed is approximately the same for a range of materials used to construct buildings and furnishings—meant that the heat release rate of materials commonly found in fires could be estimated by capturing all of the products of combustion in an exhaust hood and measuring the flow rate of oxygen in that exhaust flow. The technique was dubbed *oxygen consumption calorimetry*, notwithstanding the absence of any actual calorimetric (heat) measurements.

Later in the decade, Huggett [1] performed a detailed analysis of the critical assumption of constant proportionality of oxygen consumption to heat release. Parker's assumption was based on enthalpy calculations for the complete combustion of chemical compounds to carbon dioxide, water, and other fully oxidized compounds. Indeed, a literature review by Huggett revealed that Parker's findings were actually a rediscovery and extension of the work of W. M. Thornton [3], published in 1917, which found that the heat released per unit amount of oxygen consumed during the complete combustion of a large number of organic gases and liquids was fairly constant. Nevertheless, since in real fires and fire experiments the oxygen supply is sometimes limited, incomplete combustion and partially oxidized products can be produced. Huggett's paper examined in detail the assumption of constant heat release per amount of oxygen consumed under real fire conditions and assessed its effect on the accuracy of heat release rate determinations for fires.

Instead of expressing results on a unit volume basis, as Parker did, Huggett expressed results in the more convenient and less ambiguous unit mass of oxygen

consumed. Huggett began by presenting values for the heat of combustion and heat of combustion per gram of oxygen consumed for typical organic liquid and gas fuels, assuming the products are CO_2 , H_2O (g), HF, HCl, Br_2 , SO_2 , and N_2 . Notwithstanding large variations in the molar heat of combustion (up to a factor of 4) for this group of fuels, the heats of combustion per unit mass of oxygen consumed fell within $\pm 3\%$ of their average value of 12.72 kJ/g. Huggett explained that this near constancy was not surprising because the energetic processes are the result of breaking either carbon-carbon or carbon-hydrogen bonds, and these have similar bond strengths.

An examination of the same data for typical synthetic polymers, some of which Parker did not consider, produced similar results; for this class of materials the heats of combustion per unit mass of oxygen consumed fell within $\pm 4\%$ of their average value of 13.03 kJ/g. Fuels of natural origin (e.g., cellulose, cotton, newsprint, corrugated box, wood, etc.), which are likely to be found in large quantities in building fires, have heats of combustion per unit of oxygen consumed that range within $\pm 5.3\%$ of their average of 13.21 kJ/g.

The results presented so far assumed complete combustion. Huggett explored the effects of incomplete combustion on the assumption of constant heat release per unit mass of oxygen consumed. He did this by making several conservative, but realistic, assumptions concerning incompleteness of combustion for a range of materials likely to be found in a structural fire. For example, carbon monoxide often is present in a fire's combustion products, but usually at a very low level, and rarely exceeds 10% of the carbon dioxide concentration produced by the fire. Huggett then calculated the heat of combustion per unit mass of oxygen consumed for the burning of cellulose in limited air, such that the carbon monoxide concentration was about 10% of the carbon dioxide concentration. The result was 13.37 kJ/g of O_2 , compared with 13.59 kJ/g for the excess air case. The difference was very small and, if necessary, could be corrected for if the carbon monoxide concentration was measured.

Another consideration was that cellulosic fuels tend to form a carbonaceous char that can affect the heat release rate. By examining a hypothetical reaction that forces production of pure carbon, Huggett demonstrated that the effect was small: 13.91 kJ/g of O_2 when pure carbon was produced vs. 13.59 kJ/g when the reaction took place in excess air.

Other partial oxidation reactions can occur and affect the heat release rate. Huggett argued that although their details are unknown, the effects could be assessed via representative examples; the actual material in the example was not important since only the chemical bonds that were rearranged by the reaction significantly

affected the results. He considered partial oxidation of propylene, polyacrylonitrile (which produces hydrogen cyanide under some combustion conditions), and polytetrafluoroethylene and argued that under worst-case conditions the heats of combustion per unit mass of oxygen consumed range from 10.76 kJ/g to 13.91 kJ/g; thus such substances, if present in small quantities, would not introduce a significant error in heat release based on oxygen consumption. All these scenarios were considered limiting cases; the effect in real fires usually would be less than that presupposed in the analyses. In situations where large quantities of incomplete combustion products were produced, corrections could be made if these products were measured.

Huggett concluded that the assumption of constant heat release rate per unit mass of oxygen consumed would be sufficiently accurate for most fire and fire-test applications. For fires burning conventional organic fuels, Huggett recommended the constant 13.1 kJ/g, which should produce heat release rate results accurate to $\pm 5\%$ or better. Ever since its publication, this value has been the accepted value for oxygen-consumption calorimetry when burning conventional materials.

Huggett examined other factors that influence the overall accuracy of oxygen consumption calorimetry. For example, dilution by products of combustion in the exhaust flow, where the oxygen concentration measurement is made, is a source of error because the number of moles of products is not the same as the number of moles of oxygen consumed. This dilution factor is a function of the fuel's stoichiometry and can be taken into account if the stoichiometry is known. In general, however, this is not the case and the dilution factor must be estimated. Through analysis of limiting cases, Huggett reasoned that if an appropriate dilution factor were not available, then assuming a value of 1.6 would lead to an error of less than 6% in the amount of oxygen consumed.

This watershed paper by Huggett was published just as the rate of heat release was beginning to be recognized as the central property affecting fire growth [4]. The novel new technique was rapidly incorporated by Babrauskas and Twilley [5] in their invention of the Cone Calorimeter, a bench-scale device now used worldwide for heat release rate measurements. It also became the technique used in fire calorimeters of larger (room) size at NIST and at most fire laboratories throughout the world. The oxygen-consumption technique forms the basis for several national (ASTM [6], NFPA [7]) and international (ISO [7]) standards.

Clayton Huggett graduated from the University of Wisconsin and received his Ph.D. in chemistry from the University of Minnesota. During World War II he and his colleagues at Minnesota developed the fuel for the U.S. Navy's first air-to-air missile. Subsequently he

worked on rocket propellants with Amcel Propulsion and on the fire safety program for the Apollo rockets while at the Arthur B. Sloan Foundation, with ties to the Atlantic Research Corporation. A patent issued to him for *habitable but combustion discouraging atmospheres* still is used today. Clayton joined the Center for Building Technology at NBS in 1970 and began his research in flammability of apparel. In addition to heat release rate measurements and applications, he studied flame spread on floor coverings in corridors and the flammability of electrical insulating materials. He retired from NBS in 1985 while in the position of Deputy Director of the Center for Fire Research.

Prepared by Kenneth D. Steckler.

Bibliography

- [1] C. Huggett, Estimation of Rate of Heat Release by Means of Oxygen Consumption Measurements, *Fire Mater.* **4**, 61-65 (1980).
- [2] W. J. Parker, *An Investigation of the Fire Environment in the ASTM E 84 Tunnel Test*, NBS Technical Note 945, National Bureau of Standards, Washington, DC, August 1977.
- [3] W. M., Thornton, The Relation of Oxygen to the Heat of Combustion of Organic Compounds, *Philos. Mag., Ser. 6* **33**, 196-203 (1917). [4] V. Babrauskas and R. D. Peacock, Heat Release Rate: The Single Most Important Variable in Fire Hazard, *Fire Saf. J.* **18**, 255-272 (1992).
- [5] V. Babrauskas, Development of the Cone Calorimeter—a Bench-scale Heat Release Rate Apparatus Based on Oxygen Consumption, *Fire Mater.* **8**, 81-95 (1984).
- [6] *Standard Test Method for Heat and Visible Smoke Release Rates for Materials and Products using an Oxygen Consumption Calorimeter* ASTM E 1354-99, *Annual Book of ASTM Standards*, **4.07**, American Society for Testing and Materials, West Conshohocken, PA (1999).
- [7] *Heat Release Rates for Materials and Products Using an Oxygen Consumption Calorimeter*, (revision and redesignation of ANSI/NFPA 264-1995), ANSI/NFPA 271-1998, National Fire Protection Association, Quincy, MA (1998).
- [8] *Fire Tests—Reaction to fire—Part 1: Rate of heat release from building products—(Cone calorimeter method)*, ISO 5660-1:1993, Technical Corrigendum 1, International Organization for Standardization, Geneva (1993).

Probability-Based Load Criteria for Structural Design

Structural codes and standards provide the foundation of good engineering practice and a framework for addressing safety and serviceability issues in structural design. They identify natural and man-made forces that must be considered, define magnitudes of these forces for design, and prescribe methods for determining structural resistance to these forces. The framers of these documents on which the structural engineer places so much reliance must address the question: "How safe is safe enough?" on behalf of society as a whole. Code development is a grave responsibility and, for the most part, has clearly been done well since failures of constructed facilities are rare. On the other hand, such failures, when they do occur, are highly visible and their consequences are severe in human and economic terms for all involved. This publication, *Development of a Probability-based Load Criterion for American National Standard A58* [1], marked a major advance in the approach to formulating such codes.

At the root of the structural safety problem is the uncertain nature of the man-made and environmental forces that act on structures, of material strengths, and of structural analysis procedures that, even in this computer age, are no more than models of reality. The natural consequence of uncertainty is risk. Structural engineering, as applied to civil construction and in contrast to other engineering fields, relies heavily on analysis and computation rather than on testing because of the scale and uniqueness of typical civil projects in both public and private sectors. Structural codes are linked to computational methods of safety assessment, and their primary purpose is to manage risk and maintain safety of buildings, bridges and other facilities at socially acceptable levels.

Until the 1960s, the safety criteria in structural codes were based on allowable stress principles. The structural system being designed was analyzed under the assumption that it behaved elastically (the fact that structures seldom behave elastically to failure was disregarded). Uncertainties were addressed by requiring that the computed stresses did not exceed a limiting stress (at yielding, rupture, instability) divided by a factor of safety. These factors of safety were selected subjectively; one might, for example, identify the load acting on a structure and then design the structure so

that the elastic stresses due to that load remain below 60 % of the stress at yield (implying a factor of safety of 5/3). Of course, no one knew what the risk of failure was for such a structure. The factor of safety of 5/3 simply represented a value judgment on the part of the standard-writers, based on past experience. During the past century, with the advent of formal structural calculations, the trend in the factor of safety generally has been downward.

This judgmental approach to safety works well as long as the technology being dealt with is stable or evolves slowly and there is opportunity to learn from experience in the standard development process. Occasionally, of course, engineers become overconfident, ignorance catches up, or construction practice overreaches the state of the art; then failures occur. More than in most other engineering disciplines, the profession of structural engineering seems to have progressed by learning from its mistakes. To the discomfort of many structural engineers, this learning process usually takes place in the public arena.

During the late 1960s and 1970s, a number of natural disasters occurred worldwide that caused extensive loss of life and property damage and focused the attention of the structural engineering community and the public on the need to advance building practices for disaster mitigation. Professional staff from the Structures Division in the Center for Building Technology (CBT) of the National Bureau of Standards were involved in a number of the damage surveys and failure investigations that followed these disasters. Among the more notable of these were the structural failure investigations that followed the San Fernando, California, Earthquake of 1971, the Managua, Nicaragua, Earthquake of 1972, and the Miyagi-ken-oki Earthquake of 1978; the investigation of snow and rain load conditions prior to the collapse of the Hartford Civic Arena roof in 1978; and the evaluations of wind loads, wind load effects, and building performance following Hurricane Camille on the Gulf Coast (1969) and Cyclone Tracy in Darwin, Australia (1974). These and other investigations of building performance revealed a number of deficiencies in the provisions for structural safety appearing in the codes of practice of the time, and emphasized the need for improvements in design for natural hazards.

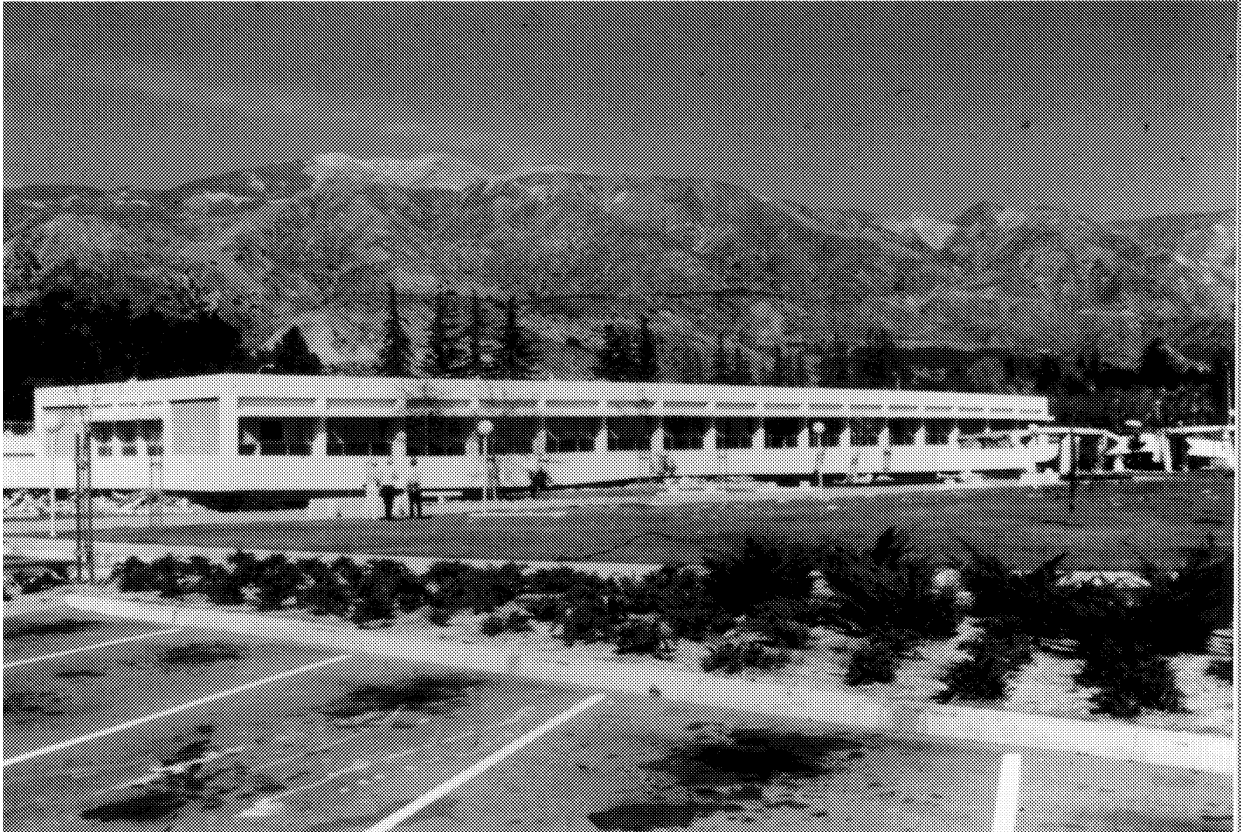

Fig. 1. Collapse of the Psychiatric Unit of the Olive View Medical Hospital (San Fernando Earthquake of February 9, 1971).



Fig. 2. Collapse of the Hartford Civic Arena roof following a winter storm with snow and freezing rain (January 18, 1978).



Fig. 3. Damage to buildings due to hurricane winds (Hurricane Camille, August 17, 1969).

The late 1960s also witnessed the beginnings of the move toward a new philosophy of structural design in the United States, Canada, and Western Europe. The shortcomings of allowable stress design were recognized in many quarters, and a search was underway for more rational approaches to distinguish between various conditions (termed limit states) that affect building performance, to ensure safety under rare but high-hazard conditions, and to maintain function under day-to-day conditions. Concurrently, the new field of structural reliability was developing around the notion that many of the uncertainties in loads and strengths could be modeled probabilistically. Advances were being made in first-order reliability analysis, stochastic load modeling and supporting statistical databases. Several probabilistic code formats were suggested [2], including an early version of Load and Resistance Factor Design (LRFD) for steel buildings [5]. However, these early proposals were relatively narrow in scope and dealt with single construction technologies in isolation from one another. With this lack of coordination, there was a risk that as different standard-writing groups moved toward probability-based limit states design, each would develop load requirements independently, and that these load requirements would be mutually incompatible in structural engineering practice, where construction technologies usually are mixed. Leaders of the profession agreed that structural load requirements must be independent of construction technology to facilitate design with different construction materials.

At that time, the Secretariat for American National Standard Committee A58 on Minimum Design Loads for Buildings and Other Structures was administered in the Structures Division of the Center for Building Technology. The antecedents at NBS for this standard dated back to 1924, when the Building and Materials Division published a report under the auspices of the Department of Commerce Building Code Committee on Minimum Live Loads. Research on probabilistic methods in structural codes was a central thrust in the CBT throughout the 1970s, with the work of Bruce Ellingwood in probabilistic analysis of live and snow loads [3,7] and load combinations for reinforced concrete design [4], and of Simiu and Marshall in wind loads [6]. This work stood at the intersection of research and practice, and its products were internationally recognized in both research and professional communities. Various standard-writing groups in the United States agreed that the A58 Standard was the logical place for material-independent load criteria to appear.

In 1978, Ellingwood accepted the challenge of leading the development of a set of common probability-based load requirements for limit states design that would be compatible with all common construction technologies. He arranged for three other leaders in reliability-based structural codes, T. V. Galambos, J. G. MacGregor, and C. A. Cornell, to join him at NBS during the summer of 1979 to develop a set of load requirements using advanced structural reliability analysis methods and statistical databases. The

objectives of this joint effort were to: (1) recommend a set of load factors and load combinations for inclusion in the A58 Standard that would be appropriate for all types of building construction (e.g., structural steel, reinforced and prestressed concrete, engineered wood, masonry, cold-formed steel and aluminum); and (2) provide a methodology for various material specification groups to select resistance criteria consistent with the A58 load requirements and their own specific performance objectives.

The product of this collaboration is NBS Special Publication 577, *Development of a Probability-based Load Criterion for American National Standard A58* [1], which was published in June 1980. Subsequent developmental work on probability-based codes in the United States in such diverse applications as buildings, bridges, offshore structures, navigation facilities, and nuclear power plants in the intervening two decades can all be traced back to this one seminal document.

The basic notions underlying the probability-based load requirements and resistance criteria contained in NBS Special Publication 577 are relatively simple. Structural failure occurs if the resistance, R , is less than the structural action, Q , due to the applied loads. If R and Q are modeled as random variables, the limit state (or failure) probability can be computed as the probability that R is less than Q [1]. Much of the early history of structural reliability revolved around difficulties in performing this computation. If a desired or target limit state probability for design can be established (by assessing historically acceptable designs, professional consensus, or legislative or regulatory fiat), then structural design should strive to achieve solutions yielding limit state probabilities close to that target value. Design solutions with higher limit state probabilities are unacceptable from a safety point of view; designs with lower probabilities are needlessly expensive.

In probability-based limit states design, the structural reliability formulation is presented in such a way as to make it practical for design by engineers who may not be familiar with reliability concepts or have access to the necessary statistical data. Structural safety requires that

$$\text{Required strength} < \text{Design strength} \quad (1)$$

where the required strength is determined from structural analysis utilizing the specified design loads, and the design strength is calculated from principles of structural mechanics with specified material strengths and structural element dimensions. With the performance requirement that the member reliability should

exceed a target reliability, Eq. (1) can be restated for practical design purposes as

$$\Sigma \gamma_i Q_i < \phi R_n \quad (2)$$

In this equation, R_n is the nominal strength corresponding to the limit state of interest and Q_i is the nominal load. These strengths and loads traditionally have been provided in codes and standards, and most engineers are familiar with them. The factors ϕ and γ_i are resistance and load factors that reflect (1) uncertainty in strength and load, and (2) consequence of failure, reflected in the target reliability measure. The right hand side of Eq. (2) is the purview of each material specification (steel, concrete, engineered wood, etc.). The left-hand side is defined for all construction materials by American National Standard A58, Building Code Requirements for Minimum Design Loads for Buildings and Other Structures [8], the national load standard referenced by the Model Codes and other regulatory documents in the United States.

The probability-based load criteria in NBS Special Publication 577 [1] were first implemented through the voluntary consensus process in the 1982 edition of American National Standard A58. They have appeared in all editions of that Standard (the standard has been published as American Society of Civil Engineers (ASCE) Standard 7 since 1985) since then, most recently ASCE Standard 7-98, and have remained essentially unchanged since 1982. They have been adopted by reference in all standards and specifications for limit states design in the United States, including the American Institute of Steel Construction's LRFD Specification for Steel Structures (1986, 1994 and 2000 editions), ASCE Standard 16-95 on LRFD for Engineered Wood Construction, and American Concrete Institute Standard 318-96 (Appendix B). They also have been adopted in the International Building Code 2000, the new single model code in the United States. In retrospect, the move toward probability-based limit states design may seem like a small step, but in fact it was not. It required a thorough re-examination of the philosophical and technical underpinnings of the current bases for structural design, as well as the development of supporting statistical databases. Much of this supporting research is still utilized in code development and improvement activities worldwide. It has become the basis for structural design as it is now practiced by professional engineers in the United States.

It is unlikely that these probability-based load criteria efforts would have been completed and implemented in professional practice successfully had they been managed by any other than CBT/NBS.

CBT was viewed as representing the structural engineering community at large rather than any one special interest group. The load criteria were completed successfully because they were developed by engineering researchers who were familiar, first of all, with the structural engineering issues involved, as well as with the reliability tools necessary for analyzing uncertainty and safety.

In a more general sense, the load criteria that were developed in this study and reported in NBS Special Publication 577 have had a profound influence on structural codes used worldwide in design of buildings and other structures. The approach taken—developing supporting statistical databases, calibrating to existing practice, and calculating load and resistance factors to achieve desired reliability levels—was followed in a subsequent National Cooperative Highway Research Program study to develop limit states design procedures for highway bridges, now published as an American Association of State Highway and Transportation Officials standard. The National Building Code of Canada will adopt a similar approach to combining loads in its 2000 edition. Standard development organizations in other countries, including Australia, New Zealand, South Africa, Japan, and Western Europe (through the Eurocodes) have adopted similar load combination requirements for structural design. The NBS Special Publication 577 load combinations have been recognized internationally as the first developed using modern probability-based load combination analysis techniques. They have stood the test of time, and only minor changes have been required as a result of additional research and advances in other areas of structural load modeling during the past two decades.

The probabilistic approach to structural safety embodied in this groundbreaking activity continues to resonate in the structural engineering community. The aftermath of natural and man-made disasters during the past two decades, rapid evolution of design and construction methods, introduction of new technologies, and heightened expectations on the part of the public, all have made judgmental approaches to ensuring safety of the built environment increasingly difficult to defend. The traditional practice of setting safety factors and revising codes based solely on experience does not work in this environment, where such trial and error approaches to managing uncertainty and safety may have unacceptable consequences. In an era in which standards for public safety are set in an increasingly public forum, more systematic and quantitative approaches to engineering for public safety are essential. The probabilistic approach addresses this

need, and in the past two decades has been widely accepted worldwide as a new paradigm, for design of new structures and evaluation of existing facilities. NBS Special Publication 577 was the path-breaking study in this area.

Bruce Ellingwood held the position of Research Structural Engineer in the Structures Division of the Center for Building Technology, NBS, at the time this work was conducted. Ellingwood was responsible for administering the Secretariat of the A58 Committee, and provided the technical leadership for the load combination development. He left NBS in 1986 to accept an academic appointment at Johns Hopkins University, where he chaired the Department of Civil Engineering from 1990 to 1997. He currently holds the Willard and Lillian Hackerman Chair in Civil Engineering, and continues to be actively involved in a number of standard-writing activities. Theodore V. Galambos was Professor at Washington University, and widely recognized as the father of LRFD for steel structures. He accepted a position at the University of Minnesota in 1981, from which he retired in 1997. He maintains an active schedule, particularly with the American Institute of Steel Construction. Professor James G. MacGregor recently retired from the University of Alberta, Canada. He has been a leading figure in both the American Concrete Institute and the Canadian Standards Association for three decades and continues his involvement with concrete standards activities in Canada and the United States. C. Allin Cornell was Professor at MIT, and had proposed one of the early probability-based structural codes in the late 1960s. In recent years as Professor at Stanford University, his research and consulting activities have involved risk analysis of offshore structures and other critical facilities and earthquake-resistant design of building structures.

A number of archival publications were prepared from the NBS study. Most notably, references [9] and [10] were awarded the American Society of Civil Engineers' Norman Medal in 1983. The Norman Medal is the oldest and most prestigious of ASCE's prizes, and is awarded annually to the paper(s) that the ASCE Awards Committee and the Board of Directors judge most significant and meritorious for the advancement of the civil engineering profession. Reference [11] was an invited contribution to the inaugural issue of the *Journal of Structural Safety*, which in the intervening period has become the leading international journal in the field of structural reliability and integrated risk assessment.

Prepared by Bruce R. Ellingwood.

Bibliography

- [1] Bruce Ellingwood, Theodore V. Galambos, James G. MacGregor, and C. Allin Cornell, *Development of a Probability-Based Load Criterion for American National Standard A58*, NBS Special Publication 577, National Bureau of Standards, Washington, DC (1980).
- [2] C. Allin Cornell, A Probability-Based Structural Code, *J. Am. Concr. Inst.* **66**, 974-985 (1969).
- [3] Bruce Ellingwood and Charles Culver, Analysis of Live Loads in Office Buildings, *J. Struct. Div., ASCE* **103**, 1551-1560 (1977).
- [4] Bruce Ellingwood, Reliability-Based Criteria for Reinforced Concrete Design, *J. Struct. Div., ASCE* **105**, 713-727 (1979).
- [5] Mayasandra K. Ravindra and Theodore V. Galambos, Load and Resistance Factor Design for Steel, *J. Struct. Div., ASCE* **104**, 1337-1353 (1978).
- [6] Emil Simiu, Michael J. Changery, and James J. Filliben, Extreme Wind Speeds at 129 Airport Stations, *J. Struct. Div., ASCE* **106**, 809-817 (1980).
- [7] Bruce Ellingwood, Wind and Snow Load Statistics for Probabilistic Design, *J. Struct. Div., ASCE* **107**, 1345-1350 (1981).
- [8] *Minimum Design Loads for Buildings and Other Structures*, ANSI Standard A58/ASCE Standard 7.
- [9] Theodore V. Galambos, Bruce Ellingwood, James G. MacGregor, and C. Allin Cornell, Probability-Based Load Criteria: Assessment of Current Design Practice, *J. Struct. Eng., ASCE* **108**, 959-977 (1982).
- [10] Bruce Ellingwood, James G. MacGregor, Theodore V. Galambos, and C. Allin Cornell, Probability-Based Load Criteria: Load Factors and Load Combinations, *J. Struct. Eng., ASCE* **108**, 978-997 (1982).
- [11] Bruce Ellingwood and Theodore V. Galambos, Probability-based Criteria for Structural Design, *Struct. Saf.* **1**, 15-26 (1982).

Resistivity-Dopant Density Relationship for Phosphorus-Doped Silicon

This paper [1], together with its companion [2], *Resistivity-Dopant Density Relationship for Boron-Doped Silicon*, documents the work done from about 1975 to 1980 to obtain a more accurate relationship between the resistivity and dopant density of silicon. The conversion between these two material properties is widely used in the semiconductor industry since silicon is the primary material which has powered the information age. A conversion is needed because many applications involve relating resistivity, which is known or can be readily measured, to dopant density, the desired quantity which is very difficult to measure directly. To model the processing of an integrated circuit, the conversion is used to calculate the surface carrier concentration of a diffused layer from the sheet resistance—junction depth product and to determine the dopant density profile from incremental sheet resistance measurements. Significant error in the results of these measurements occurs when incorrect expressions are used to relate resistivity and dopant density.

The work was initiated because of disagreements between measured values and those calculated using the existing relationships. Numerous measurement methods were used for the redetermination of the relationship for silicon doped with boron (*p*-type) or phosphorus (*n*-type). Results were obtained from more than 77 wafers, mostly donated by industry, that spanned the dopant density range from 10^{13} cm^{-3} to 10^{20} cm^{-3} . For dopant densities less than 10^{18} cm^{-3} , resistivity and junction capacitance-voltage measurements were made on processed wafers. For more heavily doped material, data were obtained from Hall effect and resistivity measurements on samples cut from bulk silicon wafers. These primary methods were supplemented for phosphorus-doped material by neutron activation analysis and a photometric technique [3], and for boron-doped material by the nuclear track technique [4]. Analytical curves were fitted to the resistivity-dopant density product as a function of resistivity and dopant density for temperatures of both 23 °C and 27 °C. Similar curves were obtained for the calculated carrier mobility as a function of resistivity and carrier density.

A comprehensive report on the work, including tables of the data and curve fitting details, was published as an NBS Special Publication [5]. For phosphorus-doped silicon, the results of this work differed by 5 % to 15 % from the then commonly used curve. For boron-doped

silicon the results differed significantly from the *p*-type curve in use at the time. A maximum deviation of 45 % occurred at a boron density of $5 \times 10^{17} \text{ cm}^{-3}$. Because of the large differences, ASTM Committee F-1 decided that the semiconductor industry needed a recommended conversion. The results of this work formed the basis of a new ASTM Standard Practice [6] for the conversion between resistivity and dopant density. It remains the accepted conversion to use, and either the original publications or the ASTM document are referenced in many papers and textbooks, as well as in five other ASTM measurement standards. The graph of dopant density vs. resistivity in Fig. 1, reproduced from the ASTM standard, is the reference chart normally used by workers in the field. This chart and the associated analytical fits are commonly referred to as the Thurber curves.

W. Robert Thurber was born in Butte, Nebraska, on July 10, 1938. He received an A. B. degree in physics from Nebraska Wesleyan University in 1960 and an M. S. degree in physics from the University of Maryland in 1963. He has been with NIST since 1962 and is presently an experimental physicist in the Semiconductor Electronics Division.

He has had broad experience in the measurement of the electrical and optical properties of semiconductors. Past projects include the electrical properties of gold-doped silicon, infrared absorption due to oxygen in silicon and germanium, and microelectronic test structures for the measurement of parameters important for integrated circuit processing. The characterization of impurities in semiconductors using deep level transient spectroscopy (DLTS) is another area of expertise. A novel method to detect nonexponential capacitance transients was developed. Thurber was heavily involved in writing an ASTM method on transient capacitance measurements and was in charge of a round robin to verify the method.

Thurber has also worked on the high-priority project to investigate the problems of infrared detectors used on the NOAA GOES satellites. An ac impedance method was developed for measuring the very high resistivity of silicon ingots used for detector applications. He also did research on the photo response in *p*-type silicon containing oxygen. Recently, he assembled a Hall effect and resistivity measurement system which he is using to characterize GaAs samples for an upcoming inter-

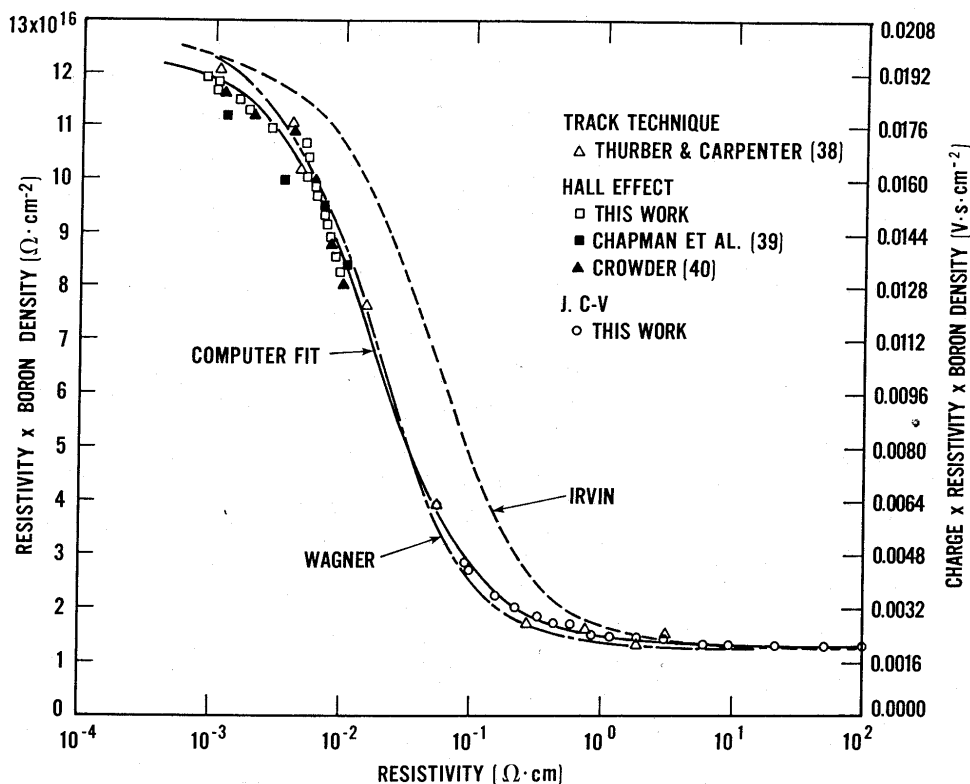

Fig. 1. One of the two “Thurber Curves”; there is a companion curve for phosphorous-doped silicon. Plotted is resistivity-dopant density product as a function of resistivity at 300 K for boron-doped silicon. The junction capacitance voltage and Hall effect measurements are compared with the published work of Thurber and Carpenter [4] and other values in the literature. The solid curve is an analytical fit to portions of these data. Values of the product of charge, resistivity, and boron density are on the right ordinate.

national Hall effect round robin which NIST will coordinate. He helped put together a tutorial Hall effect web page which invites viewer comments and will also be used to report results of the round robin.

Prepared by W. R. Thurber.

Bibliography

[1] W. R. Thurber, R. L. Mattis, Y. M. Liu, and J. J. Filliben, Resistivity-Dopant Density Relationship for Phosphorus-Doped Silicon, *J. Electrochem. Soc.* **127**, 1807-1812 (1980).

- [2] W. R. Thurber, R. L. Mattis, Y. M. Liu, and J. J. Filliben, Resistivity-Dopant Density Relationship for Boron-Doped Silicon, *J. Electrochem. Soc.* **127**, 2291-2294 (1980).
- [3] W. Robert Thurber, A Comparison of Measurement Techniques for Determining Phosphorus Densities in Semiconductor Silicon, *J. Electron. Mater.* **9**, 551-560 (1980).
- [4] W. Robert Thurber and B. Stephen Carpenter, Boron Determination in Silicon by the Nuclear Track Technique, *J. Electrochem. Soc.* **125**, 654-657 (1978).
- [5] W. R. Thurber, R. L. Mattis, Y. M. Liu, and J. J. Filliben, *The Relationship Between Resistivity and Dopant Density for Phosphorus- and Boron-Doped Silicon*, NBS Special Publication 400-64, National Bureau of Standards, Washington, DC (1981).
- [6] *Standard Practice for Conversion Between Resistivity and Dopant Density for Boron-Doped, Phosphorus-Doped, and Arsenic-Doped Silicon*, ASTM Designation: F 723-99 (originally published as F 723-81), *Annual Book of ASTM Standards*, Vol. 10.05, American Society for Testing and Materials, West Conshohocken, PA, April 2000.

Critical Data for Critical Needs

As a national laboratory dedicated to the advancement of measurement science and engineering, NBS/NIST recognized early in its history that the assessment of the quality of measurement results is a fundamental component of its mission. The 1981 paper by David Lide, *Critical Data for Critical Needs* [1], offers both a status report and a prognosis of major changes expected from the revolution in information technology that was beginning at that time.

The compilation and critical evaluation of material property data as an important NBS function can be dated to the Bureau's involvement in preparation of the *International Critical Tables* [2] in the 1920s. NBS played a leadership role in the project to produce this seven-volume series, whose contributors included hundreds of scientists from all parts of the world. The Editor-in-Chief was E. W. Washburn, Chief of the NBS Chemistry Division, and the Editorial Board included NBS Director G. K. Burgess. Many Bureau staff members contributed to the work, which is still used and cited 80 years later. Over the ensuing decades, NBS started new specialized data activities in areas such as phase equilibrium for ceramics (1930s), chemical thermodynamics (also 1930s), and atomic spectroscopy (late 1940s). However, the rapid build-up of government-supported science and engineering after World War II brought increased demands for a systematic program, fully integrated into the NBS research agenda.

NBS leaders such as Allen Astin, Edward Brady, and Lewis Branscomb worked with Congress and President Johnson's administration to establish the world's first formal government-endorsed data evaluation program. This effort culminated in the enactment of the Standard Reference Data Act of 1968 (PL 90-298, now designated as 15 U.S.C. 290). This Act of Congress established the National Standard Reference Data System (NSRDS), a coordinated and comprehensive program with an objective to "ensure that reliable reference data are easily accessible by scientists, engineers, and the general public." NBS was given the responsibility for coordination of the NSRDS, but other government agencies and private organizations were expected to participate.

In response, NBS set up a series of formal data evaluation centers that covered a wide range of physical, chemical, and materials disciplines. Joint projects were started with other agencies, professional societies, trade

associations, and foreign laboratories. Several publication channels were established, in particular the *Journal of Physical and Chemical Reference Data*, which was published in partnership with the American Institute of Physics and the American Chemical Society. This journal served not only as an outlet for compilations done at NBS, but also attracted many data reviews and compilations from outside authors. Other scientific societies were engaged to publish compilations on specialized topics. As an example, four volumes of the *Crystal Data Determinative Tables*, prepared at NBS, were published through the Joint Committee for Powder Diffraction Standards [3].

The start of the 1980s saw NBS data activities on the brink of a new era. With data evaluation procedures for different types of data now well established, taking advantage of the computer revolution became the next obvious step. At the same time, major private sector organizations realized the advantage of working with NBS to improve the quality and accessibility of data of importance in their world of interest. As this new era began, the paper *Critical Data for Critical Needs* was published in *Science*. The genesis of this paper dates to the 1980 International CODATA Conference in Kyoto, Japan, where the keynote speaker was Phillip Abelson, then Editor of *Science*. Abelson was intrigued by the talks he heard on new technology for automated retrieval and dissemination of scientific data, as well as the evidence of growing international collaboration, and he offered *Science* as a vehicle for publicizing these developments. At once the paper documents the progress towards better quality data as well as the opportunity presented by computerization and by cooperative ventures. The paper sub-headings indicate its coverage: classes of data; the growing need for good data; quality control of data bases; the electronic revolution in data dissemination; and the need for cooperation.

The discussion could not be clearer, nor the vision better defined. What had been accomplished to date was impressive, but the future was equally promising.

The paper begins by creating a context for NBS data work, namely that of the "information explosion" of the last 25 years. In reaction to this exponential increase in scientific and technical information, numerous organizations had begun creating electronic collections of literature citations, abstracts, and even documents themselves in an effort to facilitate identification and retrieval of relevant information. However, the bulk of

that work was concerned with helping users locate the scientific literature that reported research results. If users were to take advantage of the power of computers, the entire range of scientific content including *the data resulting from research*, which are usually in numerical or graphical format, would have to be available in electronic form. The remainder of the paper covered all major aspects of scientific data storage, retrieval, and dissemination.

After defining what is meant by the term “data”—repeatable measurements, observations and statistical results—Lide discussed the importance of quality in data activities. As science and engineering were confronting increasingly complex problems, from depletion of the ozone layer to shortage of critical materials, important decisions required data of the best quality to be available. With the advent of computer modeling as a major technology, data quality was even more important because of the potential for modeling results whose dependency on input data would be difficult to trace. The National Standard Reference Data System, as established by NBS, was a concerted attempt to involve expert scientists in the effort to assess the quality of reported measurements. As already mentioned, NSRDS maintained a series of continuing data centers with expertise in a well-defined discipline. Lide described several of these data centers and their current approach to evaluation of laboratory data on well-defined substances and materials. He also described parallel activities of the World Data Centers, which had been established by the International Council of Scientific Unions to perform a similar data quality assessment task for observational data in fields such as geophysics, oceanography, and atmospheric physics.

The paper then turns to the challenges of the electronic revolution and, somewhat surprisingly, defines the two paradigms for computer delivery of data that are still used today: installation on one’s own computer and access via networking to remote data collections. At the time the paper was written, the first recognizable personal computers were just beginning to appear. Yet the essential features of scientific databases stored on PCs are all addressed, namely local control, heavy use, inclusion of search software, and the facility to transfer data to computational software and other applications. The description of online data services is equally prescient, even though it was based on a model of subscription services in which the user connects directly to a remote computer rather than through the World Wide Web of the year 2000. What is particularly interesting is the recognition that users routinely require a multitude of data resources to solve real-life problems, so

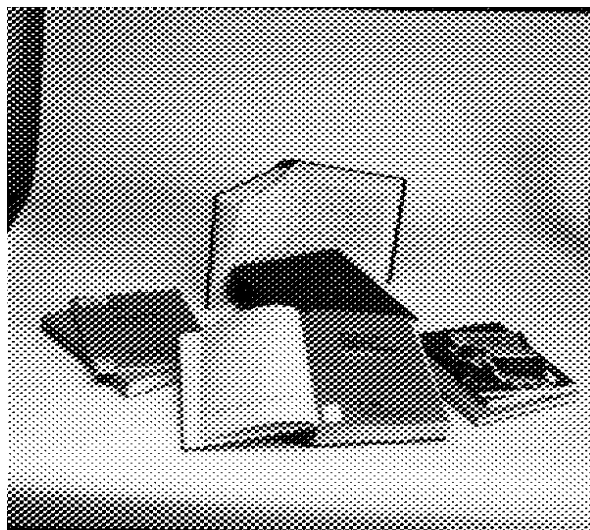

Fig. 1. A sample of current Standard Reference Data products.

that online data resources need to be integrated together to provide maximum impact and benefit.

The last major section of the paper describes a time of rapidly evolving cooperation to handle the flood of data and to take advantage of the electronic revolution. The cost of data evaluation is high, the volume of data too great, and the change in technology too rapid for any group to go it alone without ample resources. Further, in many cases, the need for consistency among collections of recommended data can be a prime motivator to work together rather than in competition. Lide mentions CODATA, the Committee on Data for Science and Technology of the International Council of Scientific Unions, as a major factor in bringing together data experts on an international basis.

The paper concludes with a prediction of three trends: the need for reliable data becoming more pressing; computer-based data dissemination methods, especially online systems, growing in use; and coordination in the development of computer-based systems being essential.

Unlike the majority of papers in this Centennial volume, this paper does not present original research results. Instead, it describes one of NBS’s largest and best-known programs, the Standard Reference Data Program. More importantly, the paper describes quite accurately what challenges the NBS data programs were facing in the last three decades of the NBS/NIST first century. At the time of publication, NBS was beginning a series of intensive and large-scale cooperative programs that changed the availability and quality of data in many areas of interest to industry. The names of the programs suffice for description:

- American Society for Metals–NBS Alloy Phase Diagram Program
- American Ceramics Society–NBS Phase Diagrams for Ceramists Program
- National Association of Corrosion Engineers–NBS Corrosion Data Program
- Design Institute for Physical Property Data (DIPPR), in cooperation with the American Institute of Chemical Engineers
- NIST fluids property data programs, in cooperation with the Gas Producers Association, the Compressed Gas Association, and the Supercritical Fluids Extraction Consortium.

The trend continues today with NIST recently forming the Research Collaboratory for Structural Biology with Rutgers University and the University of California at San Diego to operate the Protein Data Bank.

In the years following the publication of Lide's paper, NBS/NIST expanded its data activities even further to include engineering data and even data used to "calibrate" statistical and other kinds of software. At the same time, the proliferation of personal computers, as envisioned by Lide, transformed forever the dissemination of NIST/NBS data. By 1995, over 70 PC databases were available for sale from NIST. Parallel efforts on traditional online services and the Internet/World Wide Web brought even increased availability. As of May 2000, NIST was already providing online access to its evaluated data via 15 web-based systems.

The basic components of the NIST data activities in 2000 remain essentially the same as defined in Lide's paper. Quality is the defining feature. The hallmark of NIST data work remains the evaluation by recognized experts. Easy availability is equally important so that the return on the taxpayer investment in data is maximized by the widest possible dissemination of data. Finally, cooperation ensures that limited resources are not wasted on duplicative efforts and that users are not confronted by competing claims for best quality.

Data evaluation remains an important component of the overall NIST measurement portfolio, providing a

snapshot at a given time of the quality of measurement technology in different fields. NIST is the world's leader in the evaluation of physical science and other data, a tribute to the foresight and vision of leaders such as David Lide, Edward Brady, and many others. The paper *Critical Data for Critical Needs* remains a classic in defining the scope and importance of data in the advancement of science and technology and of the impact computers have had on scientific data work.

David R. Lide was hired by NBS in 1954 to set up a microwave spectroscopy laboratory in the Thermodynamics Section of the Heat and Power Division. In the early 1960s he led the integration of NBS research programs in infrared, microwave, and ultraviolet spectroscopy into a single Molecular Spectroscopy Section, which he headed until he became Director of the Office of Standard Reference Data in 1969. He was active in various national and international organizations, including stints as Secretary General and later President of CODATA and President of the Physical Chemistry Division of the International Union of Pure and Applied Chemistry. He received Department of Commerce Silver and Gold Medals and the Samuel Wesley Stratton Award of NBS for his research in spectroscopy, as well as the Herman Skolnik Award and the Patterson-Crane Award of the American Chemical Society for contributions to chemical information. After leaving NIST in 1988, he became Editor-in-Chief of the *CRC Handbook of Chemistry and Physics* and has published several other books and electronic databases.

Prepared by John R. Rumble, Jr.

Bibliography

- [1] David R. Lide, Jr., *Critical Data for Critical Needs*, *Science* **212**, 1343-1349 (1981).
- [2] Edward W. Washburn (editor-in-chief), *International Critical Tables of Numerical Data, Physics, Chemistry, and Technology*, Vols. 1-7, published for the National Research Council by the McGraw-Hill Book Company, New York (1926-1933).
- [3] J. D. H. Donnay and Helen M. Ondik (eds.), *Crystal Data Determinative Tables, Vol. 1-4*, Third Edition, National Bureau of Standards and Joint Committee on Powder Diffraction Standards, Swarthmore, PA (1972-1978).

Materials at Low Temperatures

An offhand comment by a long forgotten colleague provided the impetus to develop one of the most comprehensive books available on the study of materials at low temperature. As the 30-year era of the NBS Cryogenics Division was coming to a close, it was remarked, perhaps more than once, that the accumulated expertise of the division should be gathered and preserved. Thus, the idea was born to pull together a tutorial text and apply the resident expertise to a critical evaluation of the existing data on cryogenic materials. It is rare enough that such an opportunity presents itself, but rarer still that 13 authors should work together to create such a text. That the result had widespread impact and influence on the low-temperature community, however, was no surprise.

The book, *Materials at Low Temperatures* [1], consists of 14 chapters, each a combination of tutorial text and critical data analysis for 14 different properties of materials at cryogenic temperatures. It was written during the years 1980-1982 by the staff members of the former Cryogenics Division while the Division was being disbanded during a major reorganization, with the staff being distributed throughout three different Centers that have since evolved into three laboratories: Electronics and Electrical Engineering Laboratory (EEEL), Materials Science and Engineering Laboratory (MSEL), and Chemical Science and Technology Laboratory (CSTL). The 590-page book represents the consolidation of an estimated 600 staff-years of experience accumulated by the Division staff while it led the world in research and development of cryogenic technology. The history of that experience can be traced from its beginning with nuclear weapons, through the rapid growth of the space age, and into the world of low-temperature physics and superconductivity.

The book contains nearly 3000 references to extensive collections of theoretical and experimental work, much of it data for the critical analyses. The book is organized into the following 14 chapters:

- Chapter 1 – *Elastic Properties*, H. M. Ledbetter
- Chapter 2 – *Specific Heat*, L. L. Sparks
- Chapter 3 – *Thermal Expansion*, A. F. Clark
- Chapter 4 – *Thermal Conductivity and Thermal Diffusivity*, J. G. Hust
- Chapter 5 – *Electrical Properties*, F. R. Fickett
- Chapter 6 – *Magnetic Properties*, F. R. Fickett and R. B. Goldfarb

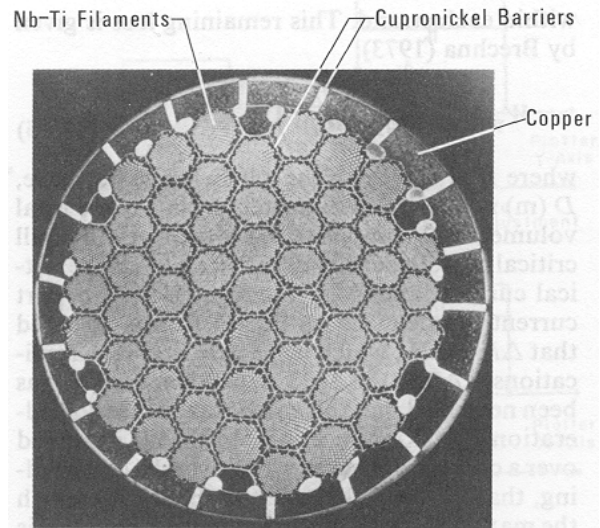

Fig. 1. Practical superconducting wires often are composite structures consisting of many fine superconducting filaments embedded in a matrix of normal metal to give the composite stability. When an ac current is passed through the superconductor, substantial energy losses can occur due to eddy currents. These losses must be minimized so that they do not heat the superconductor above its critical temperature. Subdividing the copper sheathing with sheets or fins of low conductivity Cu-Ni helps to reduce those losses. The figure shows a multifilamentary superconductor with cupronickel barriers (white areas) to prevent coupling currents from flowing around filament clusters and the outer copper stabilizing sheath. Copper areas are dark and the Nb-Ti filaments are gray. [Figure courtesy of Imperial Metal Industries.]

- Chapter 7 – *Mechanical Properties*, D. T. Read
- Chapter 8 – *Fracture Mechanics*, R. L. Tobler and H. I. McHenry
- Chapter 9 – *Martensitic Phase Transformations*, R. P. Reed
- Chapter 10 – *Compatibility of Materials with Cryogens*, J. C. Moulder and J. G. Hust
- Chapter 11 – *Structural Alloys*, H. I. McHenry
- Chapter 12 – *Composites*, M. B. Kasen
- Chapter 13 – *Superconductors*, J. W. Ekin
- Chapter 14 – *Temperature, Strain, and Magnetic Field Measurements*, L. L. Sparks

Each chapter is complete on its own, yet there is an interweaving that was done by the editors, drawing from the interactions of the authors, who were all colleagues and who compared notes and ideas as they were writing. The book is readable by the most inexperienced

layman while remaining a valuable reference to even the old hands of cryogenics. This coherent presentation is exemplified by the chapter on thermal expansion by A. F. Clark. He begins with a simple observation: "Warming a solid body from absolute zero requires energy. In a free body, this energy manifests itself in two ways: an increase in temperature and a change in volume. Both of these are directly related to the additional vibrational energy of the individual atoms; the former simply because more atomic energy states are excited, the latter because the mean interatomic distance changes with energy. The ratio of the change in energy to the change in temperature is the specific heat. The ratio of the change in volume to the change in temperature is the thermal expansion." Thus, in this remarkably lucid introduction, Clark establishes the significant conceptual relation between two extremely important properties, specific heat and thermal expansion. He goes on to explain, "... the volume expansion is due to

the anharmonic behavior of atomic vibrations and the specific heat is due primarily to the vibrations themselves..." From there, one quickly proceeds to learn about the wide-ranging importance of understanding the thermal properties, from the dimensional stability needed to maintain the critical alignment of a large telescope operating in the very cold environment of space while being warmed by the sun, to the earthbound commercial consequences of the thermal expansion or contraction of a low-temperature storage tank. In a commercial storage tank for liquefied natural gas (LNG), the tank itself cools as the LNG is added. The volume of the fully cooled storage tank may be as much as thirty thousand liters smaller than it was at the ambient temperature! Having explained the concepts and the consequences, Clark then proceeds to review the essential theoretical elements and the principal measurement methods, and concludes with an evaluation of the pertinent data.

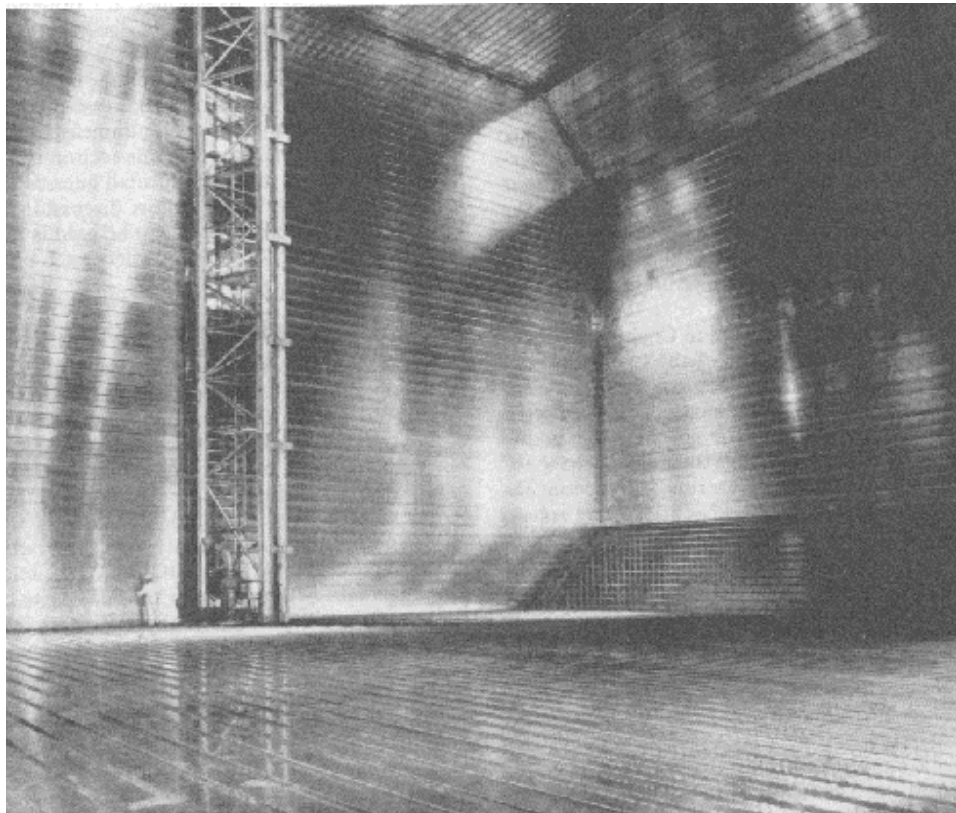

Fig. 2. An interior view of a liquefied natural gas tank lined with a low thermal expansion alloy. [Figure courtesy of McDonnell Douglas, Astronautics Laboratory and Gaz-Transport.]

The approach exemplified by Clark's chapter is followed throughout the book by a collection of authors who, at the time of writing, were considered by many to be the world's best experts on virtually all aspects of cryogenic technology. To have some of the best researchers in the field outline and explain the low-temperature behavior of materials creates an unusually complete reference. To have those same experts evaluate the available data, explain them, and indicate future research directions, creates a sound, thorough, and scientifically excellent work.

The book has been used as a text in courses on cryogenic technology and as a reference by cryogenic engineers and low-temperature physicists throughout the world. Book reviews of that time used such words as "extraordinarily useful," "extensive," "understandably written," and "indispensable reference." Personal feedback to the authors was, and some cases still is, always very positive. Two categories of users were often more lavish in their praise, those new to the field and those in the depths of low-temperature experiments, responding respectively to the tutorial text and the data evaluations, the two primary objectives of the book.

The volume, published by the American Society for Metals, sold out rapidly. Of the approximately 1000 books printed, none are still available for purchase. Copies are widely distributed in university, government, and industrial laboratories throughout the world. These books have been seen on shelves from New England to New Zealand, from China to Scotland, and from Argentina to Finland. Visits to the many laboratories that have copies show them all to be both dog-eared and treasured. But probably the strongest indication of use has come from personal feedback to the authors, all of it anecdotal and all of it very positive. Typical are "It's always within reach," "I never let it out of the office," and "It's always researched whenever we start something new."

The extent of the compilation and evaluation of data is truly comprehensive. Even today, newly measured

data fit within the ranges and predictions of the authors. The explanatory text is, of course, still valid and just as relevant as when the book was published. For anyone attempting to design, build, or interpret an experiment at low temperatures, even 17 years later or 17 years hence, the book is, and will be, an extraordinarily useful reference.

Richard Reed received his Ph.D. in physical metallurgy in 1966. At NBS, he served as Chief of the Fracture and Deformation Division through 1986. Officially retired now, he still consults on the low-temperature properties of materials. Reed and Clark are credited with founding the International Cryogenic Materials Conference, and each has served as editor of many conference proceedings and journals.

Alan Clark received his Ph.D. in physics in 1964. With a specialty in low-temperature physics and superconductivity, he has served as Group Leader of both the Superconductor and Magnetic Measurements group (NBS-Boulder) and the Fundamental Electrical Measurements group (NIST-Gaithersburg). He also has served as a Liaison Scientist for the Office of Naval Research, London. He is now Deputy Chief of the Optoelectronics Division (NIST-Boulder).

Of the thirteen authors, six are still employed at NIST, three in EEEL (Al Clark, Jack Ekin, and Ron Goldfarb) and three in MSEL (Fred Fickett, Hassel Ledbetter, and Dave Read). Five are retired from NIST (Jerry Hust, Bud Kasen, Harry McHenry, Dick Reed, and Larry Sparks); several of these now have small consulting businesses. One (John Moulder) is deceased.

Prepared by Fred Fickett.

Bibliography

- [1] Richard P. Reed and Alan F. Clark (eds.), *Materials at Low Temperatures*, American Society for Metals, Metals Park, OH (1983).

Optical Fiber Characterization

NBS Special Publication 637, *Optical Fiber Characterization* [1], is a two-volume compilation of previously published NBS Technical Notes concerning the characterization of optical fibers used for telecommunications. The Technical Notes appeared in the late 1970s and early 1980s, which was the period of commercial infancy of optical telecommunications fiber. During that period, the commercially viable fibers were of the multimode type rather than single mode; that is, they supported the transmission along the fiber of a number of electromagnetic modes having different combinations of electric field and magnetic field configurations. Consequently, SP 637 (as this publication is commonly called) is mainly concerned with the characterization of multimode fiber. While single mode fibers could be fabricated, the technology to exploit them was not readily available at the time. In the earliest fiber, large concentrations of the highly polar hydroxyl radical (OH) in the glass caused high loss at the long wavelengths effective for single-mode operation. Also, the small core size of single-mode fiber requires connectors, splices, and special sources to be aligned with high dimensional accuracy, and it took years to develop such components

that could be manufactured at an acceptable cost. Multimode fibers with core diameters in the 50 μm to 100 μm range could be easily joined with low loss, and light from laser diodes with large emitting areas could be readily launched into the large cores in a simple manner. The large core size also allowed the use of LED (light emitting diodes) sources in designing practical systems.

There were no standard measurement procedures available in the early period of development of optical fiber. An effort was started by the military to draft "mil standards" for fiber. It was a useful start, and a standards document was produced. However, the technical challenges were difficult, and rapid changes were occurring in the industry. A larger United States standards effort, principally among manufacturers, started in the Electronic Industries Association (EIA). NBS staff attended the first EIA organizational meetings where attendees determined the important technical areas and established a network of committees. It was soon evident that there was a role for NBS. Manufacturers had developed their own measurement methods, and in many instances different technical

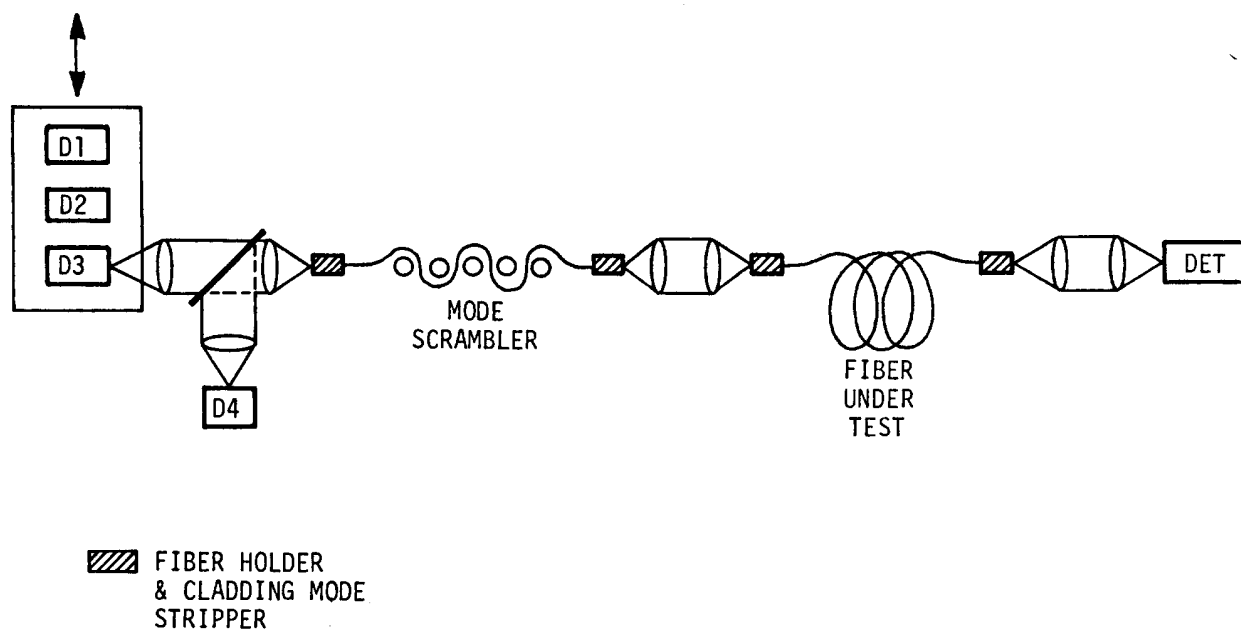

Fig. 1. A schematic diagram of early apparatus used to measure material dispersion by simultaneous propagation of pulses from pairs of laser diodes. Such measurements are important in avoiding interference between pulses of different wavelengths that are transmitted down a single optical fiber.

approaches were being employed. NBS acted as a neutral party to evaluate many procedures through round robin comparisons.

Fiber optic technology is measurement intensive. Measurements can take place at fabrication, cabling, incoming inspection, and installation. Compared to single mode fibers, multimode fibers present significant characterization problems; thus quality control measurements were a substantial production cost for multimode fiber. The large core sizes result in hundreds of propagating waveguide modes having independent loss and group delay. Consequently, the transmission properties depend on how light is launched into the fiber; i.e., which waveguide modes are excited by the source. An early measurement round robin in 1979, conducted by NBS, revealed significant interlaboratory differences in the measurement of the attenuation coefficient. Such differences resulted from difficulties in achieving a common distribution of launched light and in following a specified methodology. In subsequent years, NBS worked closely with the Electronic Industries Association (EIA, which gave birth to the Telecommunications Industry Association), at its request, to standardize light launch conditions for measuring the transmission properties of graded-index optical fibers. Many of the issues involved in selecting and creating the launching conditions are contained in the chapters of SP 637.

Another factor adding to measurement uncertainty was the use of multiple test methods based on different technical approaches. Standards groups often allowed a multiplicity of test methods for any given parameter. A

large part of the technical effort at NBS during this period was to determine the systematic differences between test methods.

It is of interest to put the work contained in SP 637 in historical perspective. Multimode fiber dominated the first telecommunication systems. The first wavelengths utilized were near 850 nm, followed later by applications at 1300 nm. In the early 1980s, the OH content of the glass, and consequently the attenuation, was greatly reduced. The highly desirable properties of single mode fiber became technically accessible, and operation was possible at a wavelength of 1550 nm, where the attenuation is a minimum. Compared to multimode fiber, single mode offers both reduced attenuation and substantially higher bandwidth. Thus today's long distance and metropolitan networks consist solely of single mode fiber.

Nevertheless, multimode fiber has found an important niche in high speed local area data networks with concepts such as "fiber to the desk" and "gigabit ethernet." The large core fiber offers inexpensive connections, high launching efficiency with large area sources, and the use of inexpensive plastic optics. Data rates for the more advanced systems are in the range of 1 Gbit/s to 10 Gbit/s. The Vertical Cavity Surface Emitting Laser (VCSEL) is a common source for high-speed multimode networks. This laser typically operates near 850 nm, which was the first wavelength window in the early multimode systems. Therefore, the contribution of SP 637 remains technically relevant to current high-speed local area networks.

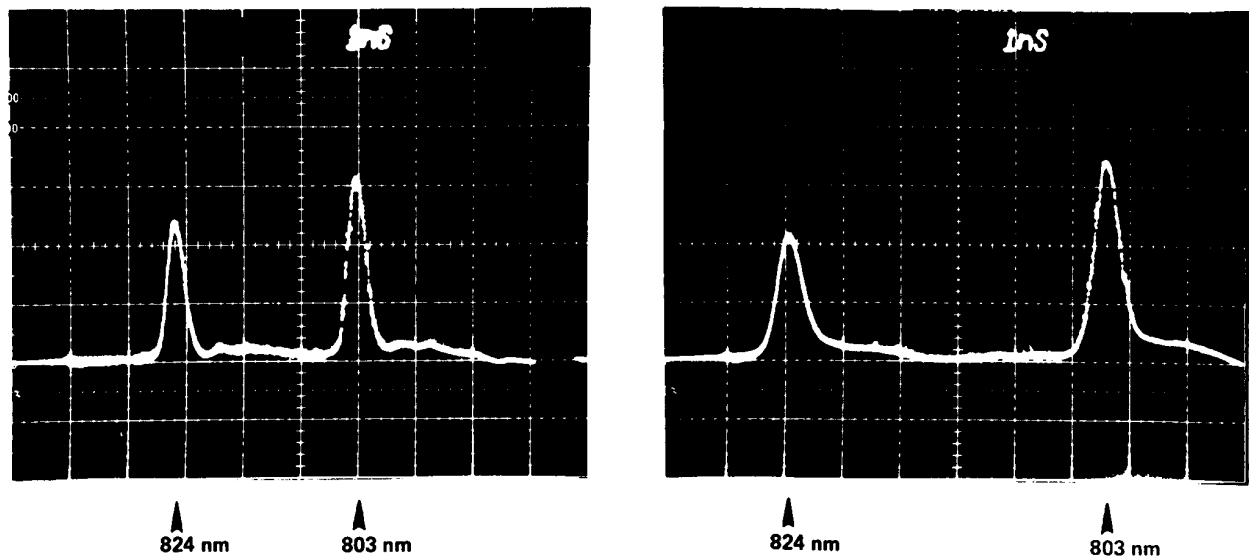

Fig. 2. An example of group-delay material dispersion with pulses at 824 nm wavelength (left pulse in each oscilloscope photograph) and 803 nm wavelength before (left photograph) and after propagating through a 1 km length of fiber.

Among the measurements on multimode optical fiber discussed in SP 637, attenuation is perhaps the most important fiber parameter because it establishes the maximum length of fiber along which signals may be sent without requiring a repeater (a device that amplifies the signal for transmission along the next section of fiber). At the time SP 637 appeared, a premium was charged for lower loss fibers, so there was a financial incentive for reliable values of the attenuation parameters. Next in importance is probably bandwidth, a measure of the potential information carrying capacity of the fiber. Bandwidth is specified in the frequency domain, but can be measured in either the time or frequency domains. SP 637 describes methods for obtaining 200 ps duration pulses from laser diodes for time-domain measurements, along with methods for launching the light into the fiber. SP 637 also describes a system for measuring the fiber frequency response directly in the frequency domain.

The author also discusses the radiation pattern of light at the exit end of the optical fiber and describes systems for measuring radiation patterns, giving comparisons with other methods for measuring core diameter and “numerical apertures.” The radiation pattern measurements are straightforward and without much controversy in their implementation, but they are important because they are commonly practiced in the trade and commerce of fibers.

SP 637 also describes a technique called “refractive-ray scanning (RNF)” to determine the refractive index profile across a fiber diameter. The index profile is not a parameter specified in the trade and commerce of fibers, but it is very important to fiber manufacturing. Only by having the appropriate near-parabolic shaped index profile can the full bandwidth potential of graded-index fibers be achieved. SP 637 describes the construction of an RNF system and a novel method for calibrating the absolute value of refractive index using a series of index-matching fluids of known refractive index.

The efforts described in SP 637 provided the impetus for future NBS/NIST programs in optical fiber metrology. In following years, the work was greatly expanded and concentrated on single-mode fibers. Within NIST, staff was added, and the program grew from project to group status. Fiber metrology is now a major component of the Optoelectronics Division. In 1980, NBS staff initiated the “Symposium on Optical Fiber Measurements.” This conference, held biennially for 20 years, is one of the premier international conferences on optical fiber measurements. NIST staff now chair committee

positions within the Telecommunications Industry Association and serve on the program committees of major conferences devoted to lightwave communications.

Douglas L. Franzen joined NBS as a National Research Council Postdoctoral Fellow in 1970 and spent his first six years developing improved methods of measuring the output power of lasers. In 1976, he and two colleagues initiated the Optical Fiber Measurement Program at NBS. Thirteen standards, which provide the measurement basis needed by manufacturers to control and enhance quality and to demonstrate compliance with purchase specifications, are based on Franzen’s research. In 1980, he helped found the biennial Symposium on Optical Fiber Measurements, and he has continued to serve as its general chairman. His work has been recognized by a number of awards, including election as a Fellow of the Optical Society of America; Department of Commerce Bronze, Silver, and Gold Medals; the Applied Research Award of NIST; and the NTT (formerly Nippon Telegraph and Telephone Corporation) Director’s Award, for collaborative work on an innovative optical sampling instrument.

Gordon W. Day has been a leader in optoelectronics work at NBS/NIST since 1976. He has advanced the NIST efforts to meet special measurement needs of the emerging lightwave communications industry, especially for optical fibers, lasers, and optical fiber sensors. In 1993 he was given the responsibility of forming a new division at NIST dealing with optoelectronics. Day’s research has been in the metrology related to optoelectronics and has resulted in more than 130 publications and a variety of awards, such as the Gold and Silver Medals of the Department of Commerce, two IR-100 Awards from R&D Magazine, and a Technology Transfer Award from the Federal Laboratories Consortium. He is a fellow of both the Institute of Electrical and Electronics Engineers (IEEE) and the Optical Society of America. In 1999-2000 he was President of the IEEE Lasers and Electro-Optics Society.

Prepared by D. L. Franzen.

Bibliography

- [1] G. E. Chamberlain, B. L. Danielson, G. W. Day, D. L. Franzen, R. L. Galawa, E. M. Kim, and M. Young, *Optical Fiber Characterization, Volumes 1 and 2*, NBS Special Publication 637, National Bureau of Standards, Gaithersburg, MD (1982).

Quasicrystals

The well ordered world of solid materials was forced to reassess its rules of order by the spectacular results of D. Shechtman, I. Blech, D. Gratias, and J. W. Cahn [1]. By the year 1801, the fundamental laws of crystal morphology had been well established, and in the last two decades of that century, theories of the internal symmetries of crystals were being discussed [2]. Early in the following century, 1912-1916, the development of x-ray diffraction techniques allowed the periodic arrangement of atoms in a crystal to be established experimentally [3]. By 1984 it was universally accepted that an x-ray diffraction pattern with sharp peaks could only be the result of a periodic arrangement of atoms or molecules occurring in a crystalline solid, and every possible crystal symmetry was known [4].

In general, crystals are classified according to their allowed translational and rotational symmetry operations. Each possible crystal lattice is characterized by having a smallest structural unit, called a unit cell, and when those cells are stacked together face-to-face, an infinite region of space can be filled without leaving a single hole. Quite notable in the mathematics of crystal symmetry is the impossibility of a three dimensional crystal possessing a five-fold axis of rotation.

“We report herein the existence of a metallic solid which diffracts electrons like a single crystal but has point group symmetry $m\bar{3}5$ (icosahedral) which is inconsistent with lattice translations.” [1]

That pronouncement appearing in *Physical Review Letters* in 1984 heralded the discovery of a new class of materials, now called quasicrystals, which possessed the heretofore forbidden icosahedral point symmetry!

It is not surprising that there followed immediately several years of raging controversy regarding the origin of the diffraction symmetry, but importantly, sufficient results from electron diffraction experiments were reported in this initial paper to confirm that the icosahedral symmetry was indeed real. The primary point of contention was the well-known experience that disallowed diffraction patterns could be produced artificially as a result of a superposition of multiple allowed, but rotated, patterns. As a crystal is grown, it is not uncommon for the growth direction to change suddenly resulting in a process called twinning. Indeed, John Cahn said [5], “My reaction was, ‘Go away, Dany. These are twins and that’s not terribly interesting.’”

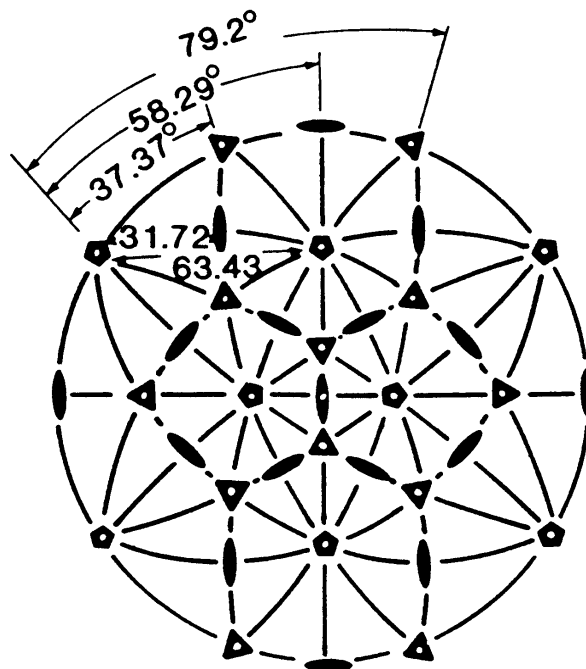

Fig. 1. Stereographic projection of the symmetry elements of the icosahedral group $m\bar{3}5$.

However, to produce the five-fold symmetry, twinning would have to occur five times in succession. That hypothesis can be tested experimentally by focusing the diffraction beam on smaller and smaller regions of the specimen. When the size of the diffraction volume becomes too small to enclose all five twins, the five-fold symmetry must disappear. Such was not the case in the work of Shechtman, Blech, Gratias, and Cahn! The five-fold symmetry persisted to the smallest dimension that was examined, about 10 nm, and there was no evidence of twinning.

Rather quickly, a number of models were developed to explain the icosahedral symmetry of the diffraction patterns. The leading contenders were a relatively disordered “icosahedral glass” phase and a highly ordered tiling model.

The icosahedral glass model, initially proposed by Shechtman and Blech [6] and developed by Stephens and Goldman [7], is composed of many interconnected aligned polyhedra of icosahedral symmetry. These glasses possess long range orientational order, but no long range translational symmetry. Although these structures do not form a regular lattice, models indicate



Fig. 2. John Werner Cahn, NIST Senior Fellow, received the 1998 National Medal of Science, conferred by the President of the United States on the recommendation of the National Science Foundation.

that they are able to produce diffraction peaks as sharp as those that were measured in the earliest icosahedral phases. However, the glass models have too great a degree of disorder to be consistent with the extremely sharp diffraction spots of icosahedral phases such as Al-Cu-Fe and Al-Cu-Ru phases that were observed subsequently.

The tiling models are based on a concept devised by Roger Penrose in 1974 for tiling the plane quasiperiodically using two tile shapes rather than a single unit cell [8]. In 1981 Alan Mackay generalized the Penrose tiling to three dimensions using two types of rhombohedra [9]. In the following year, Mackay designated the two- and three-dimensional patterns as “quasi-lattices” and speculated on possible structures where atoms sit on the quasi-lattice points of the 2-D structure. He showed that these structures give rise to optical diffraction patterns with ten-fold symmetry! In 1984 Peter Kramer and Reinhardt Neri of Tübingen [10] and Dov Levine and Paul Steinhardt [11] of the University of Pennsylvania independently developed a three-dimensional generalization of Penrose tilings by projecting a three dimen-

sional cut through a higher-dimensional periodic lattice. These three-dimensional tilings filled space using two or more rhombohedra and the calculated diffraction patterns were quite similar to the 3-fold and 5-fold patterns published by Shechtman, *et al.* Other models using the 6-D projection approach were developed and shown to be capable of matching the diffraction patterns quite well.

By rotating tiles or clusters of tiles in a Penrose pattern, structures intermediate to the perfectly ordered Penrose tiling models and the icosahedral glass models can be obtained. This additional disorder generates a strain which is consistent with the experimentally observed systematic broadening of diffraction spots. The disordered tiling model thus can account for the varying degrees of strain observed for various alloy systems. It has been suggested that the presence of disorder even contributes to the stability of the structures through an increase in entropy.

The physical realization of quasicrystals and the intellectual understanding of their formation thus has been achieved. At the foundation of this discovery is the work of Shechtman, Blech, Gratias, and Cahn, which has spawned an entirely new branch of materials science. Already, papers numbering in the thousands have been published on this subject in the disciplines of physics, crystallography, and mathematics. It may be noted that Shechtman and Cahn have continued to lead, stimulate, and encourage much of this work.

Dan Shechtman is the Philip Tobias Professor of Materials Science at the Israel Institute of Technology (Technion, Haifa, Israel). His work on both the theoretical and experimental aspects of quasi-periodic structures has earned him numerous awards. He received the Physics Award from the Friedenbergs Fund for the Advancement of Science and Education in 1986; the International Award for New Materials from the American Physical Society in 1987; the New England Academic Award of the Technion for Academic Excellence in 1988; the Rothchild Prize in Engineering in 1990; and the Weizmann Prize in Science in 1993. While quasicrystals remain a major focus of his work, he is also pursuing research on chemical vapor deposited (CVD) diamond wafers, metallic multilayers, and rapidly solidified metallic alloys.

John Cahn has had a remarkably prolific career as scientist and teacher. He has published approximately 250 papers and delivered approximately 400 invited lectures to technical audiences worldwide. The excellence of his work has been recognized in more than thirty national and international awards, including the

Nation's highest scientific award, the National Medal of Science (1998). He was conferred with membership in both the National Academy of Sciences (1973) and the National Academy of Engineering (1998). He has received gold medals from organizations as diverse as the U.S. Department of Commerce, the Japan Institute of Metals, and Acta Metallurgica. He has been accorded the status of Fellow at NIST, the American Academy of Arts and Sciences, the Japan Society for the Promotion of Science, the American Institute of Metallurgical Engineers, and the ASM International. He has been honored no less than eleven times as a Distinguished Lecturer and has received honorary doctorates from Universit d'Evry (France, 1996) and Northwestern University (1990), and an honorary professorship from Jiao Tong University (Shanghai, China, 1980). His awards for distinguished work include the Harvey Prize (Israel Institute of Technology, 1995), the Rockwell Medal (International Technology Institute, 1994), the Hume-Rothery Award (AIME, 1993), the Michelson and Morley Prize (Case Western University, 1991), the Sauveur Award (ASM International, 1989), the Stratton Award (NBS, 1986), the von Hippel Award, (Materials Research Society, 1985), the Dickson Prize (Carnegie-Mellon University, 1981), and the S. B. Meyer Award (American Ceramic Society, 1966). He is currently Senior Fellow in the NIST Materials Science and Engineering Laboratory where he is continuing his pioneering work on the thermodynamics and kinetics of phase transitions, diffusion, and interface phenomena.

Prepared by Ronald Munro in consultation with Frank Gayle and Carol Handwerker.

References

- [1] D. Shechtman, I. Blech, D. Gratias, and J. W. Cahn, Metallic Phase with Long-Range Orientational Order and No Translational Symmetry, *Phys. Rev. Lett.* **53**, 1951-1953 (1984).
- [2] P. P. Ewald (ed.), *Fifty Years of X-Ray Diffraction*, International Union of Crystallography (1962).
- [3] J. M. Bijvoet, W. G. Burgers, and G. Hägg (eds.), *Early Papers on Diffraction of X-rays by Crystals*, International Union of Crystallography (1969).
- [4] F. W. Gayle, Introduction to: Metallic Phase with Long-Range Orientational Order and No Translational Symmetry, in *The Selected Works of John W. Cahn*, W. Craig Carter and William C. Johnson (eds.), The Minerals, Metals & Materials Society, Warrendale, Pennsylvania (1998).
- [5] Mort La Brecque, Opening the Door to Forbidden Symmetries, *Mosaic (Washington, D.C.)* **18** (4) 2-13+ (1987/8).
- [6] D. Shechtman and I. A. Blech, The Microstructure of Rapidly Solidified Al₆Mn, *Metall. Trans. A* **16A**, 1005-1012 (1985).
- [7] Peter W. Stephens and Alan I. Goldman, Sharp Diffraction Maxima from an Icosahedral Glass, *Phys. Rev. Lett.* **56**, 1168-1171 (1986).
- [8] R. Penrose, The Role of Aesthetics in Pure and Applied Mathematical Research, *Bull.-Inst. Math. Appl.* **10**, 266-271 (1974).
- [9] Alan L. Mackay, De Nive Quinquangula: On the Pentagonal Snowflake, *Sov. Phys. Crystallogr.* **26**, 517-522 (1981).
- [10] P. Kramer and R. Neri, On Periodic and Non-periodic Space Fillings of E^m Obtained by Projection, *Acta Crystallogr.* **A40**, 580-587 (1984).
- [11] Dov Levine and Paul Joseph Steinhardt, Quasicrystals—A New Class of Ordered Structures, *Phys. Rev. Lett.* **53**, 2477-2480 (1984).

Protein Crystallography by Joint X-Ray and Neutron Diffraction

By 1984, the quest to understand the internal dynamics of protein molecules had created a pressing need for well-refined, high resolution data on protein structures. In a landmark contribution to the field of protein crystallography [1], Wlodawer, Walter, Huber, and Sjölin undertook an innovative joint application of x-ray and neutron diffraction methods to determine the structure of a new crystal form of bovine pancreatic trypsin inhibitor (BPTI). This work was the first to determine the atomic positions in a protein of this size to within the diameter of a hydrogen atom. By comparing structures from two crystalline forms of BPTI, the paper offered the first detailed analysis of how protein structure is affected by molecular packing. In addition, the paper provided the first detailed experimental picture, atom-by-atom, of hydrogen-deuterium exchange in a folded protein, revealing the existence of eleven “protected” amine hydrogens which exchanged at anomalously slow rates. This work also established that joint x-ray-neutron refinement could produce structural detail consistent with the then emerging technique of two-dimensional NMR protein crystallography and provided the baseline data for the further development of multi-dimensional NMR.

X-ray and neutron beams falling on a crystal are diffracted by its atomic constituents, and the periodic structure of the crystal causes the diffracted rays to be sharply defined. The directions and intensities of the diffracted rays are sensitively determined by the three-dimensional arrangement of the atoms and by specific aspects of their interactions with the incident radiation. Proteins do not occur as crystalline material in nature. However, it is possible to grow their structures artificially into crystals, which then can be studied by diffraction methods. BPTI previously had been prepared in a crystalline form (form I) that was not suitable for high resolution studies but, importantly, Walter and Huber had just succeeded in synthesizing BPTI into a new crystalline form (form II) that appeared to be more promising [2] for structural studies.

Protein crystallography raises many challenges. It is hard to make protein crystals of the size and quality needed for diffraction studies. Even with good data, the large number of atoms in proteins and their steric complexity make it difficult to determine such structures accurately at resolutions near 0.1 nm (1 Å), the diameter of a hydrogen atom. A major theoretical

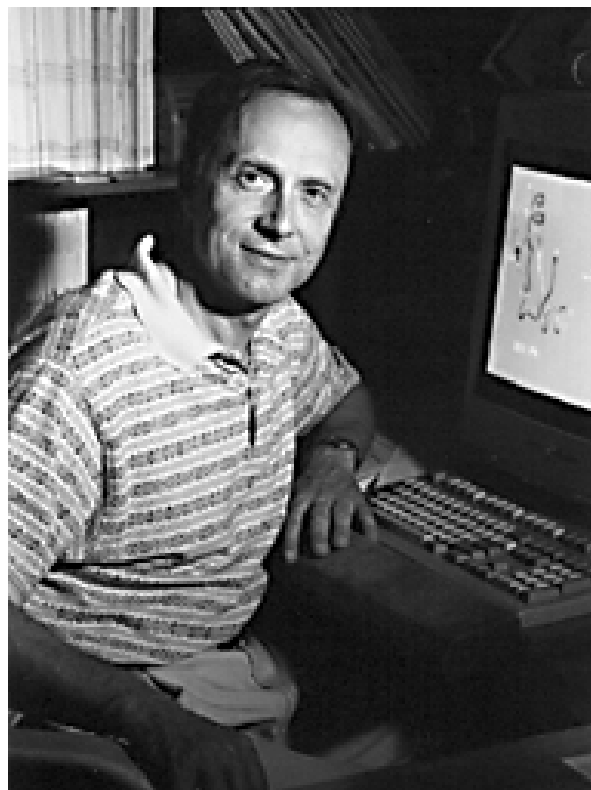

Fig. 1. Alexander Wlodawer, ca. 1999.

constraint also intrudes. Diffraction patterns depend only on pairwise relationships among atomic positions, and these are not unique attributes of structures. Protein crystallography does not yield a direct route from the experimental data to the atomic structure. The determination of atomic positions requires analytical procedures in which putative structures are refined against the data in stages of increasing detail, a computationally intensive process in which chemical and biological knowledge and intuition play significant parts.

Bovine pancreatic trypsin inhibitor is one of the most thoroughly studied of all proteins, even though it is of minor biological moment. BPTI was interesting at the time of this work because it is a small protein (only 58 amino acids) with well-understood functionality. Its three-dimensional structure had already been determined to 2.5 Å resolution using x-ray diffraction and related techniques as early as 1970 by Robert Huber and coworkers [3] in a crystal form that became known as

form I. Subsequent studies had increased the x-ray resolution of the structure to 1.5 Å, and a large amount of work on BPTI structure and dynamics using various techniques had appeared in the 1970s and early 1980s. In fact, BPTI was the first protein for which detailed experimental information about the folding of the polypeptide chain became available. The quality of protein crystals was the major limitation to increasing the resolution of diffraction studies. In the early 1980s resolution was extended to an ångstrom or slightly less, but in proteins smaller than BPTI.

The work described in the 1984 paper was started when coauthor Lennart Sjölin, Wlodawer's postdoctoral worker at NBS (but then already on the faculty of the Chalmers Polytechnic in Goteburg, Sweden), learned that coauthors Robert Huber (who would win the 1988 Nobel Prize in Chemistry) and Jochen Walter at the Max-Planck-Institute for Biochemistry in Martinsried, Germany, had managed to grow a new crystal of BPTI, which they called form II. In Alex Wlodawer's words: "Since that molecule was at that time the 'hydrogen atom' of protein chemistry, and most physico-chemical techniques being developed were initially tested with it, we wanted very much to take neutron data on that protein. The previously available crystals, however, were tricky to grow and simply not good enough—they did not grow very large and did not diffract very well. So the new crystal form, growing easily, large, and with superb diffraction, was of clear interest. Lennart got Huber and me together on this project, and we were off and running." The authors also were alert to the scientific implications of having a new crystal form of BPTI to compare with the well-characterized form I, so that changes in protein structure could be correlated with the different molecular packings in the two forms.

However, Alex continues: "In the meantime, we found out that Wayne Hendrickson, one of the most prominent American crystallographers, also had these crystals, and we were afraid that he would go after the neutron data at Brookhaven." Wlodawer and Hendrickson, together, had already pioneered the simultaneous refinement of x-ray and neutron data in 1982 [4], showing that it can provide more information about protein structure than either type of data alone. Hydrogen locations, in particular, can be determined more precisely with neutrons since hydrogen is a strong neutron scatterer while being nearly invisible to x rays. "So there was also an element of competition as well," Alex allows. Wlodawer and Sjölin were in a good position to move quickly, since they had already published several papers on the joint refinement technique and were well armed with methodology. Moreover, neutron beam time and excellent instrumentation were available to them at the NBS Research Reactor, and Division 856 (the Reactor Radia-

tion Division, now the NIST Center for Neutron Research) possessed a Vax 11/780, one of the most powerful minicomputers of the day, and an Evans & Sutherland display system, the most powerful tool available for three-dimensional visualizations of molecular structures.

Although Alex mentions the form II BPTI crystals as "growing easily," the 1984 paper describes an involved preparation protocol, including a two-month period of undisturbed growth from a seed crystal, followed by another three months for heavy water exchange for the neutron measurements. Heavy water greatly reduces background neutron scattering from the protein crystal. In addition, the exchange of deuterium atoms from the heavy water for hydrogen atoms in the structure provides additional information about the hydrogen locations in the protein. Curiously, the paper informs us that the heavy water used "was manufactured in 1983 by the facility in Rjukan, Norway." Alex explains: "The heavy water that we used came from the famous facility in Rjukan, Norway, and was produced in 1938. As many know, the Allies took great pains to destroy the place during WWII to prevent the Germans from having access to heavy water. So, in the page proofs, I had the bright idea that since half the authors were German, I should just insert the Rjukan bit (otherwise having no bearing on the contents of the paper). I did just that in the Materials and Methods section (p. 303), and then forgot about it. Last year, however, I told the story to somebody who looked up the paper and told me that the year of production of the sample was given as 1983, killing the joke. Clearly, an eager editor caught my 'obvious' error in transposing the numbers (how could anybody use a 1938 sample in 1984?) and 'corrected' me. So it goes."

The paper did not have an immediate impact, but after a year's gestation its influence grew very rapidly. Wlodawer attributes its long-range influence to several factors. The work resulted in one of the best-refined protein structures at that time, and so the paper has been extensively quoted as a baseline for the quality of protein structures. The work on hydrogen-deuterium exchange was influential, since interest in the kinetics of exchange persisted for some time. Also, its results bear on many fields of current interest, including protein folding and protein chemistry. Its achievement of a high resolution protein structure, especially the accurate hydrogen positions, was, and continues to be, influential in the field of NMR, which is also sensitive to hydrogen locations. Since BPTI had been chosen as a platform for the development of two-dimensional NMR in the early 1980s, the appearance of this paper was very well timed from a historical perspective. "I suspect the paper will be cited for quite a few years longer," Alex says.

The paper concludes with the words: “This paper is dedicated to Professor Paulina Wlodawer on the occasion of her seventieth birthday.” Alex adds: “On a personal note, I am happy that this is the paper that will have its lifetime extended by inclusion in the NIST history. This was the only paper ever that I dedicated to my mother, who is a biochemist and provided major impetus for me becoming a scientist. Thus if one of my papers should be remembered, I am glad that this is the one.”

Alexander Wlodawer, a native of Poland, received his Ph.D. from the University of California, Los Angeles, in 1974. Having completed his postdoctoral training at Stanford University, he joined the National Bureau of Standards in 1976, where he engaged in many studies of protein crystallography until 1987, when he moved to the ABL-Basic Research Program at the National Cancer Institute-Frederick Cancer Research and Development Center. From October 1998 to March 1999, he was on sabbatical as an elected Visiting Fellow of Sidney Sussex College, University of Cambridge. In 1999 Wlodawer was appointed the Associate Director of the Program in Structural Biology in the Division of Basic Sciences of the National Cancer Institute, where he is Chief of the Macromolecular Crystallography Laboratory and of the Protein Structure Section. He is a member of the American Crystallographic Association and the Protein Society and has been an elected officer in both organizations.

Robert Huber shared the 1988 Nobel Prize in Chemistry with Johann Deisenhofer and Hartmut Michel for “the determination of the three-dimensional structure of a photosynthetic reaction centre.” He is in the Department for Protein Crystallography at the Max-Planck-Institut für Biochemie, Martinsried, Germany. Lennart Sjölin is an Associate Professor in the Department of Inorganic Chemistry, Protein Crystallography Group, at the Chalmers University of Technology in Goteborg Sweden.

Prepared by Norman F. Berk.

Bibliography

- [1] A. Wlodawer, J. Walter, R. Huber, and L. Sjölin, Structure of Bovine Pancreatic Trypsin Inhibitor, Results of Joint Neutron and X-ray Refinement of Crystal Form II, *J. Mol. Biol.* **180**, 301-329 (1984).
- [2] J. Walter and R. Huber, Pancreatic Trypsin Inhibitor—a New Crystal Form and Its Analysis, *J. Mol. Biol.* **167**, 911-917 (1983).
- [3] R. Huber, D. Kukla, A. Rühlmann, O. Epp, and H. Formanek, The Basic Trypsin Inhibitor of Bovine Pancreas. I. Structure Analysis and Conformation of the Polypeptide Chain, *Naturwissenschaften* **57**, 389-392 (1970).
- [4] A. Wlodawer and W. A. Hendrickson, A Procedure for Joint Refinement of Macromolecular Structures with X-ray and Neutron Diffraction Data from Single Crystals, *Acta Crystallogr. A* **38**, 239-247 (1982).

Strain Effects in Superconducting Compounds

This paper [1] was presented by invitation at the 1983 International Cryogenic Materials Conference at a crucial point in the scale-up of superconductor magnet applications. It synthesizes a wide range of electromechanical strain data into what has become known as the Strain Scaling Law, which has had a strong impact on the design of large-scale, high-field superconductor magnet coils since that time. The Strain Scaling Law was the result of a unique high-field electromechanical measurement capability, developed by Jack Ekin at NBS, which led to the discovery and systematization of the intrinsic strain effect in practical superconductors.

In the years leading up to this work, it was known that superconductors have a “critical surface” that is a function of temperature, current density, and applied magnetic field. It had not been known that the critical surface also depends on an additional fundamental parameter, mechanical strain. Fig. 1 shows the scaling of the superconductor critical surface with this variable.

This discovery was especially important to the development of large-scale superconductor applications because early work had focused only on small coils of superconducting wire in which the magnetic forces were small. However, the need to handle large forces emerged with the development of large-scale magnets for particle accelerator machines, magnetic plasma confinement in fusion energy, superconducting magnetic energy storage (SMES), and medical magnetic resonance imaging (MRI) systems.

Ekin had focused primarily on the electrical properties of metals and superconductors in his thesis work at Cornell University and postdoctoral work at Rutgers University before joining NBS in 1975. The focus of his group at NBS was predominantly on mechanical properties, which led him to probe the unexplored niche between the electrical and mechanical research worlds. This coincidence of two fields of expertise ultimately resulted in the discovery of the superconductor strain effect and the Strain Scaling Law.

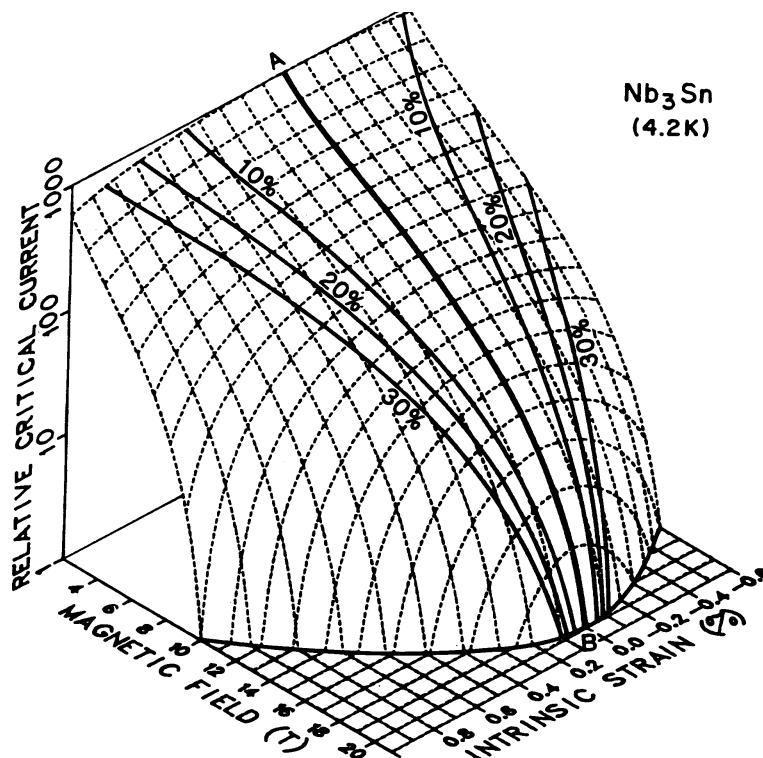

Fig. 1. J - B - ϵ critical surface for multifilamentary Nb_3Sn superconductors.

Prior work in this unique electromechanical field was scarce and had focused on small experimental samples of new superconducting materials, including thin films [2], monofilamentary wires [3], and single crystals [4]. However, the intrinsic non-hydrostatic strain effect was not measured in practical filamentary NbTi conductors until 1975, when the first measurements on the effect of strain on critical current (I_c) were reported by Ekin, Fickett, and Clark [5]. The interaction could not be explained simply by superconductor filament breakage, heating, or cross-sectional area reduction, but appeared to be intrinsic to the superconducting material itself.

About a year later, a much larger effect of strain on I_c was found in multifilamentary Nb₃Sn conductors by Ekin [6], Easton and Schwall [7], and McDougall [8]. This area of research then expanded when an accompanying strain effect was found for critical temperature T_c [9,10], as well as the upper critical field (B_{c2}) [11,12]. Ekin's systematic high-field measurements synthesized these effects into a strain scaling law that was first presented by him in a widely cited earlier paper in 1980 [13]. Then, in *Strain Effects in Superconducting Compounds*, he demonstrated that the Strain Scaling Law had wide applicability in virtually all practical high-field superconductors at the time. Fig. 2 is the first set of nearly universal curves showing the effect of

strain on the upper critical field B_{c2} of the set of superconductors having the A-15 crystal structure. Each of these curves corresponds to the thick-line curve shown in the base plane of the critical surface in Fig. 1; they are the prime determinant of the entire superconductor critical surface.

The paper also presented the first strain-effect data on a relatively new superconductor, Nb₃Al. As seen in Fig. 2, Nb₃Al has a remarkably small strain effect in comparison with Nb₃Sn, the most widely studied superconductor of the day. This discovery of the relative strain insensitivity of Nb₃Al resulted in an international effort to produce this superconductor material commercially in practical lengths. That goal has been realized, and Nb₃Al is currently being explored for use in a new class of high-field magnets made using a much more efficient "react-and-wind" technique. These magnets are being developed for use in energy storage, high energy physics accelerators, and medical imaging systems.

Today, NIST continues to be the world leader in electromechanical measurement techniques, particularly since the advent of high-temperature superconductors, as well as the mechanical challenges inherent to these brittle ceramic oxide materials. Most superconductor applications are also being scaled up in size with an attendant increase in magnet stress, underscoring the

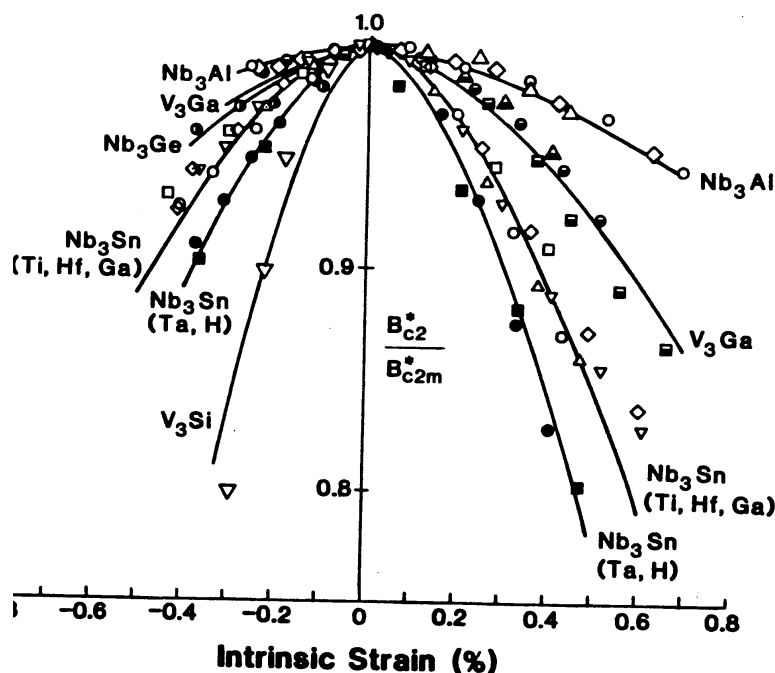

Fig. 2. Effect of uniaxial strain on the upper critical field of practical A-15 superconductors.

need for precise measurements of electromechanical performance. NIST measurement expertise is also sought for its third party independence in evaluating superconductor performance, particularly with the expansion of superconductor applications in the electric power industry, which is currently undergoing deregulation.

Jack Ekin was born in Pittsburgh, Pennsylvania, on August 31, 1944. He received a B.S. degree in physics from the University of Michigan, Ann Arbor, in 1966; a Fulbright Scholarship for beginning graduate study in physics at the University of Heidelberg; and a Ph.D. in solid state physics from Cornell University in 1971. From 1971 to 1973 he was a Postdoctoral Research Associate at Rutgers University. In 1973, he joined NBS through a National Research Council Research Associateship. He joined the permanent staff at NBS as a research physicist in 1975, where his work has specialized in the study of electromechanical properties of superconductors, transport properties and critical current measurements, thin film interfaces in high temperature superconductors, and development of low resistivity contacts to high temperature superconductors. He has published over 150 articles and several book chapters on low-temperature transport properties of superconductors and normal metals, and received six patents for superconductor fabrication methods and devices. Currently, his research at NIST is focused on electromechanical measurements for the development of the "second generation" high temperature superconductors, the extension of the Strain Scaling Law from one to three dimensions, and the writing a textbook on cryogenic measurement techniques.

Prepared by J. W. Ekin.

Bibliography

- [1] J. W. Ekin, Strain Effects in Superconducting Compounds, *Adv. Cryo. Eng.* **30**, 823-836 (1984).
- [2] W. A. Pupp, W. W. Sattler, and E. J. Saur, Superconductivity of Thin Nb₃Sn Films Under Tensile Stress, *J. Low Temp. Phys.* **14**, 1-13 (1974).
- [3] J. P. McEvoy, Effect of uniaxial stress on the superconducting transition temperature of monocrystalline Nb₃Sn, *Physica* **55**, 540-544 (1971).
- [4] M. Pulver, Kritisches Verhalten von V₃Si und Nb₃Sn unter uniaxialen Zug im transversalen Magnetfeld, *Z. Phys.* **257**, 261-271 (1972).
- [5] J. W. Ekin, F. R. Fickett, and A. F. Clark, Effect of stress on the critical current of niobium-titanium (NbTi) multifilamentary composite wire, *Adv. Cryo. Eng.* **22**, 449-452 (1977).
- [6] J. W. Ekin, Effect of stress on the critical current of Nb₃Sn multifilamentary composite wire, *Appl. Phys. Lett.* **29**, 216-219 (1976).
- [7] D. S. Easton and R. E. Schwall, Performance of multifilamentary Nb₃Sn under mechanical load, *Appl. Phys. Lett.* **29**, 319-321 (1976).
- [8] I. L. McDougall, Stress induced degradation of critical currents in filamentary Nb₃Sn, in *Proceedings of the Sixth International Cryogenic Engineering Conference, Grenoble, 11-14 May 1976*, K. Mendelssohn (ed.), IPC Science and Technology Press, Guildford, England (1976) pp. 396-399.
- [9] Thomas Luhman and M. Suenaga, The influence of thermally induced matrix stresses on the superconducting properties of Nb₃Sn wire conductors, *IEEE Trans. Magn.* **MAG-13**, 800-802 (1977).
- [10] H. Hillmann, H. Kuckuck, H. Pfister, G. Rupp, E. Springer, M. Wilhelm, K. Wohlleben, and G. Ziegler, Properties of multifilamentary Nb₃Sn conductors, *IEEE Trans. Magn.* **MAG-13**, 792-795 (1977); G. Rupp, Improvement of the critical current of multifilamentary Nb₃Sn conductors under tensile stress, *IEEE Trans. Magn.* **MAG-13**, 1565-1567 (1977).
- [11] G. Rupp, Stress induced normal-superconducting transition in multifilamentary Nb₃Sn conductors, *IEEE Trans. Magn.* **MAG-15**, 189-192 (1979).
- [12] J. W. Ekin, Strain dependence of the critical current and critical field in multifilamentary Nb₃Sn composites, *IEEE Trans. Magn.* **MAG-15**, 197-200 (1979).
- [13] J. W. Ekin, Strain scaling law for flux pinning in practical superconductors. Part 1: Basic relationship and application to Nb₃Sn conductors, *Cryogenics* **20**, 611-624 (1980).

Dental Research at the National Bureau of Standards

George Colby Paffenbarger was a man of considerable insight. Nearing the end of his life as a result of prostate cancer, he perceived a need to educate the dental profession and the public about the enormous benefits to dentistry and public health that were being wrought through the cooperative research of the American Dental Association (ADA) and the National Bureau of Standards. Tax dollars, allocations from ADA dues, and funding from the National Institute of Dental Research were being used to support this work, and it was important for everyone to know that this investment was yielding benefits which far exceeded costs. Elsewhere, an oversupply of graduating practitioners and a reduced demand for dental care was leading to the closing of some dental schools and an attendant pressure to reduce all sources of funding for dental research. What George Paffenbarger saw, and others did not, was the continued evolution of (then unappreciated) dramatic benefits from dental research, even as the primary emphasis for research began to shift away from treatments for caries (the incidence of which had already declined) to treatments for other oral diseases and conditions. Paffenbarger's solution to this problem was to publish a paper [1] that would place the ADA/NBS dental research program into a clear and succinct context.

Paffenbarger undertook this project in collaboration with John A. Tesk and W. E. Brown at NBS. Together, they documented the development of modern dental materials research, beginning with the inception of a dental research program at NBS in 1919.

The beginning can be traced to a request by the U.S. Army to develop a bid specification for the purchase of dental amalgam. That effort, headed and championed by Dr. Wilmer Souder, focused on the properties of amalgams, including their compositions, dimensional changes on setting, compressive strengths, and flow characteristics [2]. That work led to the collaboration between NBS and the Weinstein Research Laboratory to measure the physical properties of the whole range of materials being used by dentists, for which the literature of the day was rather scant and often controversial [3]. The impact of that eight-year study is credited with the development of the cooperative program of the ADA and NBS, which continues to this day.

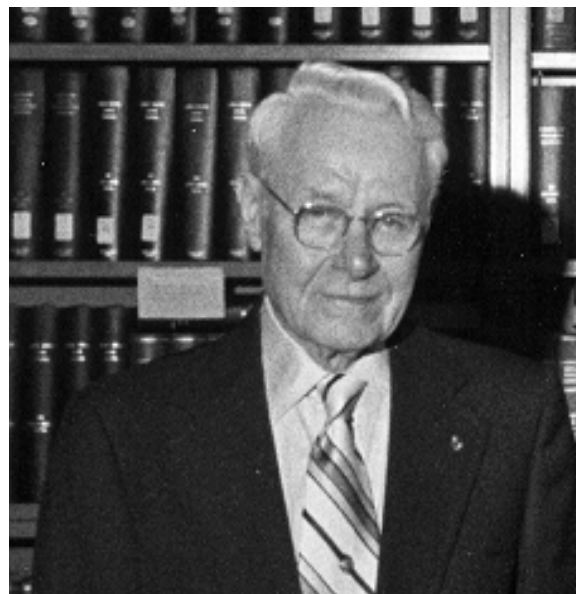

Fig. 1. George C. Paffenbarger.

The review by Paffenbarger, Tesk, and Brown paints a picture of a remarkable and far-reaching program that touches on every aspect of dentistry and, hence, public health. The thrust of the program was not simply the measurement of properties or even the development of standards and certification programs. Dental professionals and the public needed to be informed about the significance of the results, particularly with respect to self-serving promotions of products that had been propagated unchecked early in the century. "Aside from probable deceptive claims (for the exploitation of dental materials) exposed in the individual surveys, reports were published by the Association at NBS showing the fraudulent nature of some of the deceptions." [1]

Dental practices were also an important part of the program. As the ADA/NBS program began to understand more about the physical and chemical properties of amalgams, the influence of impurities and contaminants on the degradation of restorations also began to be understood. In one case, the practice of dentists mulling the amalgam mix in the palms of their hands was found to add moisture and sodium chloride to the mix, which subsequently led to severe corroding of zinc-bearing amalgams [4].



Fig. 2. The contra-angle handpiece, developed in the ADA/NBS program, is used in virtually every modern dental office in the world.

The growth of the ADA/NBS program was breathtaking in itself. Since the 1950s, the program has included research on crystal structures, crystal chemistry of minerals, solubility studies, calcium phosphate cements, topical fluoridation procedures, enamel etching, the formation mechanisms of caries, the *in situ* microanalysis of carious and sound enamel, the characterization of cardiovascular calcifications, and the development of new materials and instruments. Among the most noteworthy developments that sprang from this program are the modern high-speed-turbine, contra-angle handpiece; the panoramic x-ray unit; modern dental composite restoratives and sealants; and the national and international standards programs for dentistry.

With respect to the waning support for dental research in the mid-1980s, this accounting by Paffenbarger et al. was successful in helping to sway the members of the ADA to preserve its support of dental research and to seek alternative methods to help curtail the rise in ADA dues. It was clear that the ADA/NBS program had saved the public and the dental profession billions of dollars over the years, at a cost that seemed insignificant in comparison to the benefit.

George Paffenbarger received the degree of DDS from Ohio State University in 1924 and after a brief time in private practice and teaching, joined the research staff of the ADA at NBS in 1929. During part of his tenure, Paffenbarger served as Director of the ADA research unit at NBS. Among his most recognized research contributions were his investigations into the stability of both dental impression materials and polymer based denture materials, and studies of the retentive mechanisms of dental cements. He also became a staunch champion of the modern tooth-colored composite restoratives that emanated from the research of R. Bowen (another accomplished ADA researcher at NBS). He was also instrumental in the

development of dental standards activities throughout the world. Paffenbarger was recognized by numerous academic institutions, including Ohio State (his alma mater), Fairleigh Dickenson, Georgetown, and Nihon (Japan) Universities, through the receipt of honorary degrees. St. Andrews University, Scotland, invited him to be Praelector In Dentistry for the Faculty of Medicine. He was an honorary member of numerous national and international dental societies and organizations, including the ADA, the Japanese Dental Association, the Federation Dentaire Internationale, and French, German, British, Argentine societies. He was also a Fellow of the Washington Academy of Science. He was the recipient of an almost countless number of awards, including the Wilmer Souder award, the highest award for dental materials research bestowed by the International Association for Dental Research (IADR, a society that he also helped to found). During World War II, Paffenbarger served in the United States Navy, with responsibility for procurement and testing of dental supplies. By 1959, when he retired from the United States Naval Reserve, he had risen to the rank of Rear Admiral. When he lectured before domestic dental societies he was known to emphasize the importance of dental research by saying “now this is something that you paid for, but look at what you’ve gotten in return.” He was an unyielding opponent of the drawing of conclusions from poor research and unsubstantiated results, but he was a warm, friendly mentor for those who recognized the need for improvements in their work and who sought his counsel to strive toward the ideals of excellence that embodied his life.

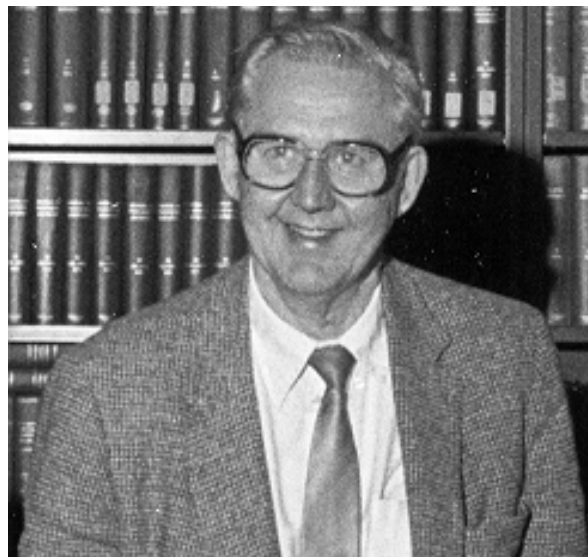

Fig. 3. Walter E. Brown.

Walter Brown received his Ph.D. degree from Harvard University in 1949. From 1948 to 1962 he conducted research on the crystallography and chemistry of calcium phosphates for the Tennessee Valley Authority. In 1962 he joined the ADA research unit at NBS, where he directed research on the solubility and crystal chemistry of mineralized tissues, including tooth calculus. He became director of the ADA unit in 1967 and served in that capacity until his retirement in 1983, after which he continued as a research associate until his death, from Parkinson's disease, in 1993. Brown, like Paffenbarger, received numerous honors and awards. He was recognized universally for his contributions to the crystallography, chemistry, and biochemistry of calcium phosphate compounds. His theories are among the main underpinnings of modern calcium phosphate chemistry. His pioneering studies of the physicochemical properties of mineralized tissues, such as teeth and bone, provided the foundation for much of the modern research on diseases such as dental caries, osteoporosis and arteriosclerosis, and in the development of topical fluoride treatments for teeth. His work also lay at the heart of modern calcium biomaterials. During his life it was said that he was known "from biomineralization to fertilizer" and he delighted in both the truth and the humor of that statement. Among his awards were the Mineralized Tissue Research award of the IADR, the highest award of its kind; an NBS citation for "Outstanding Leadership of the ADA Research Group at NIST," and the Rudjer Institute (Zagreb, Yugoslavia) Founder's Plaque for "contributions to scientific exchange"; he was also an honorary member of the ADA. He followed Paffenbarger as Director of the ADA research unit at NIST.

John Tesk received his Ph.D. degree from Northwestern University in 1963. Prior to his NBS experience, which began in 1978, his career encompassed employment as: Engineer-in-Training with a company in the natural gas industry; Assistant Professor of Materials Engineering at the University of Illinois, Chicago; consultant to Argonne National Laboratory on low temperature neutron damage in metals and, later, Assistant Metallurgist with Argonne on the development of the breeder reactor; Director of Research with a dental company; and Director of Education Services, with the Institute of Gas Technology, for training of engineers and technicians in Algeria. As an employee of NBS, he served as Leader of the Dental and Medical Materials Research group, which included the ADA researchers, from 1983 to 1994. In 1994 he was given the assignment of searching for other health-related needs toward which NIST expertise might be applied. In



Fig. 4. John A. Tesk.

1995, along with Stephen Hsu (a renowned tribologist in the Ceramics Division) and six of the world's largest orthopedic companies, he formed the first orthopedic Cooperative Research and Development consortium in the Materials Science and Engineering Laboratory. The consortium's goal was to develop a reliable, accelerated screening test for orthopedic implant joint bearing materials (wear being a primary cause necessitating the removal of these joint implants). Because of the variety of both his experiences and the topics of his publications, John often joked that he was "*known well* for not being *well known*." His honors include the Bronze Medal from NBS and awards from the ADA and the American Society for Testing and Materials for work in national and international standards. In 1998, for contributions made in collaboration with many Japanese dental researchers (including a best paper award, co-author, Professor Kenzo Asaoka) he became the third foreigner elected to honorary membership in the Japanese Society for Dental Materials.

Prepared by John Tesk and Ronald Munro.

Bibliography

- [1] G. C. Paffenbarger, J. A. Tesk, and W. E. Brown, Dental Research at the National Bureau of Standards: How It Changed the Practice of Dental Health Service, *J. Am. Dent. Assoc.* **111**, 83-89 (1985).
- [2] W. Souder and C. G. Peters, Investigation of Physical Properties of Dental Materials, *Dent. Cosmos* **62**, 305-335 (1920).
- [3] R. L. Coleman, Physical Properties of Dental Materials (Gold Alloys and Accessory Materials), *Bur. Stand. J. Res.* **1**, 867-938 (1928).
- [4] I. C. Schoonover, W. Souder, and J. R. Beall, Excessive Expansion of Dental Amalgam, *J. Am. Dent. Assoc.* **29**, 1825-1932 (1942).

Handbook for Standard Reference Materials Users

Standard Reference Materials (SRMs) are well-characterized materials produced in quantity and certified for one or more physical or chemical properties. They are issued under the NIST trademark and are characterized using state-of-the-art measurement methods. SRMs are designed to ensure the accuracy, traceability, and compatibility of measurement results in many diverse fields of science, industry, and technology both in the United States and throughout the world. SRM users recognize that reliable measurements can help avoid costly manufacturing mistakes and unnecessary over-design of products and systems. Good measurements can provide the basis for sound and economical environmental and safety regulations and can improve health care by enhancing the validity of clinical tests and procedures. Thus the use of SRMs for measurement reliability contributes to the strength of this nation's economy and the well being of its citizens.

Many users of SRMs are interested in the details of the procedures used at NIST to certify the SRMs. In 1985, the late John Keenan Taylor prepared SP 260-100, *Handbook for SRM Users* [1] to provide guidance for the use of SRMs and to explain the philosophy behind the SRM Program. The book is dedicated to the dissemination of information on the phases of preparation, measurement, certification, and use of SRMs. While written from the viewpoint of a chemist, the basic concepts described are applicable to most areas of metrology. Taylor arranged the *Handbook* by sections in a logical progression, starting with the concepts of precision and accuracy, followed by discussions of calibration procedures and quality assurance of the measurement process, the use of SRMs to evaluate various kinds of measurements, and the reporting of data with evaluated limits of uncertainty. The statistical considerations most frequently applicable for the evaluation and interpretation of measurement data are reviewed in the Appendices. Each section is written with some degree of independence so that it can be comprehended without frequent reference to the content of others.

The original *Handbook* was published in 1985 and required a second printing in 1987. In 1992, work was begun on a revision of Special Publication 260-100 [2] to upgrade dated information and to reflect significant changes that had occurred within NIST and the Standard Reference Materials Program since the document was

first issued in 1985. N. M. Trahey of the Standard Reference Materials Program performed an extensive editorial and technical review of the *Handbook* and its appendices. The text was determined to be consistent with current NIST guidance on measurements, but various sections and appendices (including Sections 8 and 9, Appendices A, B, and C, and the Guide for Requesting Development of Standard Reference Materials) required revision. There were extensive revisions in Appendix C. Statistical Tools, rewritten in accordance with current NIST policy by S. B. Schiller of the NIST Statistical Engineering Division. Two other sections and the remaining appendices were rewritten by N. M. Trahey, who also prepared new introductory material. The editing process had not yet begun when John Taylor passed away, and every effort was made to preserve those parts of the text that Taylor had prepared, essentially as he wrote them. Fifteen years after the original *Handbook for SRM Users* was published, the Standard Reference Materials Program continues to get approximately 800 requests for copies per year.

The National Bureau of Standards began to provide reference materials, originally known as standard samples, in 1906 in response to the needs of the metals industry. The SRM inventory has since become far more diverse and now contains over 1300 different SRMs and related samples. A large number of materials useful in physical metrology and engineering are included. Some technical areas are covered more completely than others for historical reasons, priorities for national issues, and to some extent the degree of industrial awareness of the quality assurance concept. Modern SRMs take into consideration the fact that a given substance for which an analysis is carried out may occur in different matrix environments. Thus the users must be made aware of the need to take the specific environment into account.

The *Handbook* is still making an impact on SRM users. It contains some of the course material used by John Taylor to teach classes at NBS/NIST and at national and international meetings of the American Chemical Society and the Pittsburgh Conference on Analytical Chemistry and Applied Spectroscopy. At those meetings Taylor spent many hours in dialogues with reference materials users, analysts, and accreditors regarding reference materials and their importance in the metrology of chemical and physical measurements. Eight years after his death, the *Handbook* continues to

spark conversations with those who knew him and used his book. Former students are eager to tell how his teachings influenced their careers, and they cite the *Handbook* as one book they consider a collector's item that they will always keep in their library.

For 3 years at the Pittsburgh Conference, the Standard Reference Materials Program honored the author by sponsoring the *J. K. Taylor Symposium on the Development and Use of Reference Materials*. Taylor himself conceived the workshop, based on his feeling that U.S. industry needed to be both educated and informed of NIST's Standard Reference Materials role regarding measurement quality and data comparability.

John Keenan Taylor joined the National Bureau of Standards in 1929 at the age of 16; while working at the Bureau, he received his B.S. in Chemistry from George Washington University and later his PhD in Physical Chemistry from the University of Maryland. Over the course of a professional career spanning 57 years, Taylor performed research and directed activities in the Microanalysis, Gas and Particulate Science, and Standard Samples (a forerunner of the Standard Reference Materials Program) Sections of the NBS Analytical Chemistry Division. Even after his retirement from NBS in 1986, he devoted much of his time and attention to measurement quality control and assurance in the field of analytical chemistry. Taylor served as coordinator for Quality Assurance of the NIST Chemical Science and Technology Laboratory and continued to write articles, design seminars, and teach

classes on the subject of quality assurance as applied to chemical measurements until shortly before his death on March 26, 1992.

Taylor was honored by the Department of Commerce with its Silver and Gold Medals. He was a member of the American Chemical Society, the Alpha Chi Sigma Chemical Fraternity, the American Institute of Chemists (AIC), and several ASTM technical committees, including Committee D22 on Sampling and Analysis of Atmospheres which he chaired from 1984 to 1990. He received an Award of Merit from ASTM, the Fitch Memorial Chemistry Award from George Washington University, the DC Educational Society Award, the AIC Honor Award, and the Chemical Society of Washington Achievement Award. He authored three books and some 200 scientific journal publications, served as editor of four books, and held two patents.

Prepared by Thomas E. Gills.

Bibliography

- [1] John K. Taylor, *Handbook for SRM Users*, NBS Special Publication 260-100, National Bureau of Standards, Gaithersburg, MD (1985).
- [2] John K. Taylor (edited by Nancy M. Trahey), *Handbook for SRM Users*, 1993 Edition, NIST Special Publication 260-100, National Institute of Standards and Technology, Gaithersburg, MD (1993).

A Practical Josephson Voltage Standard at One Volt

This paper [1] is considered the seminal, definitive paper describing the revolutionary one-volt Josephson-junction array standard. NIST changed forever high-accuracy voltage measurements with this development, which built on earlier work at NIST and a microwave feed design from the then West German standards laboratory, Physikalisch-Technische Bundesanstalt (PTB). The basic element of the array is the Josephson junction, in the form of a superconductor-insulator-superconductor sandwich. When irradiated with microwave energy, such a junction exhibits a dc potential uniquely determined by the frequency of the radiation, the electronic charge, and Planck's constant, with a single junction providing a few millivolts. In other words, a Josephson junction can act as a superb frequency-to-dc voltage converter. A properly designed and fabricated array of junctions can be excited to produce a series of very accurate quantized voltages, or steps.

As developed and demonstrated by the NIST team [1-8], a Josephson-junction-based voltage standard system consists of microwave source and feed, cryostat, probe, chip, and readout and control system. Microwave energy is fed into the chip mounted in the probe's chip carrier and cooled by liquid helium. The array standard microchip is fabricated by techniques analogous to those used to fabricate silicon integrated circuits, although with very different material systems.

For almost 80 years, starting in 1901, the U.S. Legal Volt was maintained by several groups of standard cells. There was a large effort in the late nineteenth century and the early twentieth century to establish a standard for electromotive force (emf) based on electrochemical reactions within chemical cells. The first legal unit of voltage for the United States was based on the Clark cell, developed by Latimer Clark in 1872, with its output assigned a value of 1.434 international volts by the 1893 International Electric Congress. Public Law 105, passed by the U.S. Congress in 1894, made this the legal standard of voltage in the U.S. During the years between 1893 and 1905, the standard cell devised by Edward Weston was found to have many advantages over the Clark cell [9]. The Weston cell consists of a cadmium amalgam anode and a mercury-mercurous sulfate cathode with a saturated cadmium sulfate solution as the electrolyte. In 1908, at the London International Conference on Electrical Units and Standards, the

Weston cell was officially adopted for maintaining the volt. After 1908, only Weston cells were used for maintaining the national standard in the United States.

The Weston standard cell can be disturbed by transport or if it is subjected to a change in temperature or a small electrical current. When at times it was necessary to eliminate cells—due to changes in emf of a cell relative to the mean of the group—new cells could be added. In 1965 the National Reference Group of standard cells [10] included 11 cells made in 1906, seven cells made in 1932, and 26 cells made in 1948. Long-term stability of the volt reference was also maintained by comparisons of neutral and acid cells, preparing and characterizing new cells, and through international comparisons and absolute ampere and ohm experiments. According to Driscoll and Olsen [11], the results of the absolute current-balance measurements could be regarded “as assigning a value to the emf of the standard cell used to control the strength of the current” and as a check on the emf of the NIST standard cell bank. The use of the Weston cell as the national standard of voltage was supported by a considerable amount of research in electrochemistry and related fields at NBS.

Before the Josephson effect was discovered, it was difficult to provide incontrovertible evidence regarding the long-term stability of the U.S. Legal Volt. However, considerable evidence indicated that the unit of emf preserved with standard cells was unlikely to have changed by any significant amount, relative to the best measurements of the time, from the early 1900s to the 1960s.

In the late 1950s, research in solid-state physics stimulated the growth of the semiconductor industry. A new type of voltage standard based on a solid-state device, the Zener diode, appeared in the early 1960s. W. G. Eicke at NBS first reported the possibility of using Zener diodes as transport standards [12]. In the following years, after several manufacturers started making commercial Zener voltage standards, these references began to replace standard cells in commercial use. Although Zener voltage standards exhibit higher noise characteristics than standard cells and are affected by environmental conditions of temperature, atmospheric pressure, and relative humidity, they are now widely used in many metrology laboratories because of their robust transportability.

In 1962, Brian Josephson, a graduate student at Trinity College, Cambridge, England, predicted that electrons can tunnel in pairs (Cooper pairs) between two superconductors separated by a thin insulating barrier (a weak link or Josephson junction). An applied dc voltage V across the barrier would generate an ac current at the frequency $f = 2eV/h$, where e is the elementary charge and h is Planck's constant. Conversely, an applied ac current of frequency f would generate a dc voltage V_n at the quantized values

$$V_n = nhf/2e ,$$

where n is an integer and the value of $2e/h$ is approximately 483.6 MHz/ μ V.

One of the issues was whether this relationship was materials independent. In 1968 Parker, Langenberg, Denenstien, and Taylor [13] compared, via a potentiometer, the Josephson voltages of junctions consisting of five different superconducting materials and various combinations of thin-film tunnel junctions or point contacts with 1.018 V Weston saturated standard cells [10] calibrated by NBS. They obtained a value of $2e/h$ with a one-standard-deviation fractional uncertainty of 3.6×10^{-6} .

It was argued on fundamental grounds that the above must be exact. The use of superconducting-quantum-interference device (SQUID) null detectors in the early 1970s allowed this to be tested to a few parts in 10^9 , and thus the Josephson effect had obvious potential for use as a voltage standard [14]. By the early 1970s, NIST staff had set up a potentiometric measurement system in Gaithersburg that compared 2 mV to 10 mV dc Josephson junction voltages with 1.018 V standard cells to a few parts in 10^8 [15,16]. International comparisons in 1971-72 among national metrology institutes (NMIs), including NBS, the National Physical Laboratory (NPL) in the U.K., the National Research Council (NRC) in Canada, the National Standards Laboratory (NSL) in Australia, and the Physikalisch-Technische Bundesanstalt (PTB) in Germany, as well as the International Bureau of Weights and Measures (BIPM), found that the measured values of $2e/h$ agreed with each other to within 2×10^{-7} [17].

These results from the NMIs suggested the course of adopting a value of $2e/h$ for use in maintaining units of voltage. The United States was the first nation to do this, and the value of $2e/h$ to be used at NBS was chosen to prevent a discontinuity when NIST converted from standard cells to the Josephson effect [18]. NBS began maintaining and disseminating the U.S. volt based on the Josephson effect in July 1972, using a 10 mV measurement system with relative uncertainty of 2×10^{-8} . Soon after, the Consultative Committee on

Electricity (CCE) of the CIPM recommended the value $K_{J-72} = 483\,594$ GHz/V, which was adopted by all countries except the United States, France, and the Soviet Union.

In many applications, Josephson junctions were undoubtedly better references than standard cells, which are sensitive to environmental conditions, can shift values on transport, and can drift by a few parts in 10^8 per year. The typical 5 mV to 10 mV reference output from early Josephson devices made from a few junctions required both very low-level voltage balances and scaling by a factor of 100, both of which seriously limited the accuracy of measuring 1.018 V standard cells.

Then in 1977, M.T. Levinson and colleagues showed that unbiased Josephson junctions would spontaneously develop quantized dc voltages when irradiated with microwaves, opening the path to successful Josephson junction arrays. C. A. Hamilton, R. L. Kautz, F. L. Lloyd, and others of the NBS Electromagnetic Technology Division at Boulder began developing and improving Josephson standards based on series arrays of junctions operated near zero dc voltage bias [3,19].

Stable 1 V zero-crossing arrays were operating at NBS [1] and PTB [20] by 1985, using about 1500 junctions and rf fields of 70 GHz to 90 GHz. Arrays with output voltages at the level of 1 V soon were used in NMIs throughout the world [21]. By 1989, NIST had made a 19 000 junction, 12 V array [2]. The widespread use of Josephson junction arrays in national standards laboratories, and better SI determinations of $2e/h$, led the CCE to recommend a new exact conventional value for the Josephson constant:

$$K_{J-90} = 483\,597.9 \text{ GHz/V} ,$$

which is fractionally larger by 8×10^{-6} than the 1972 conventional value. The new value was adopted worldwide on January 1, 1990, and thereby became the new basis for the U.S. Legal Volt. This definition of K_{J-90} is the present volt representation, based on an ideal Josephson voltage standard. The conventional value was assumed by the CCE to have a relative standard uncertainty of $0.4 \mu\text{V/V}$. By convention, this uncertainty is not included in the uncertainties of the representation of the volt, since any offset from the SI volt will be consistent among different laboratories using the Josephson effect standard.

The term "intrinsic standard" is sometimes used to describe a type of standard, such as a Josephson Voltage Standard (JVS), quantum Hall resistance standard, triple point cell, deadweight pressure gauge, etc., based on physical laws rather than on the stability of physical

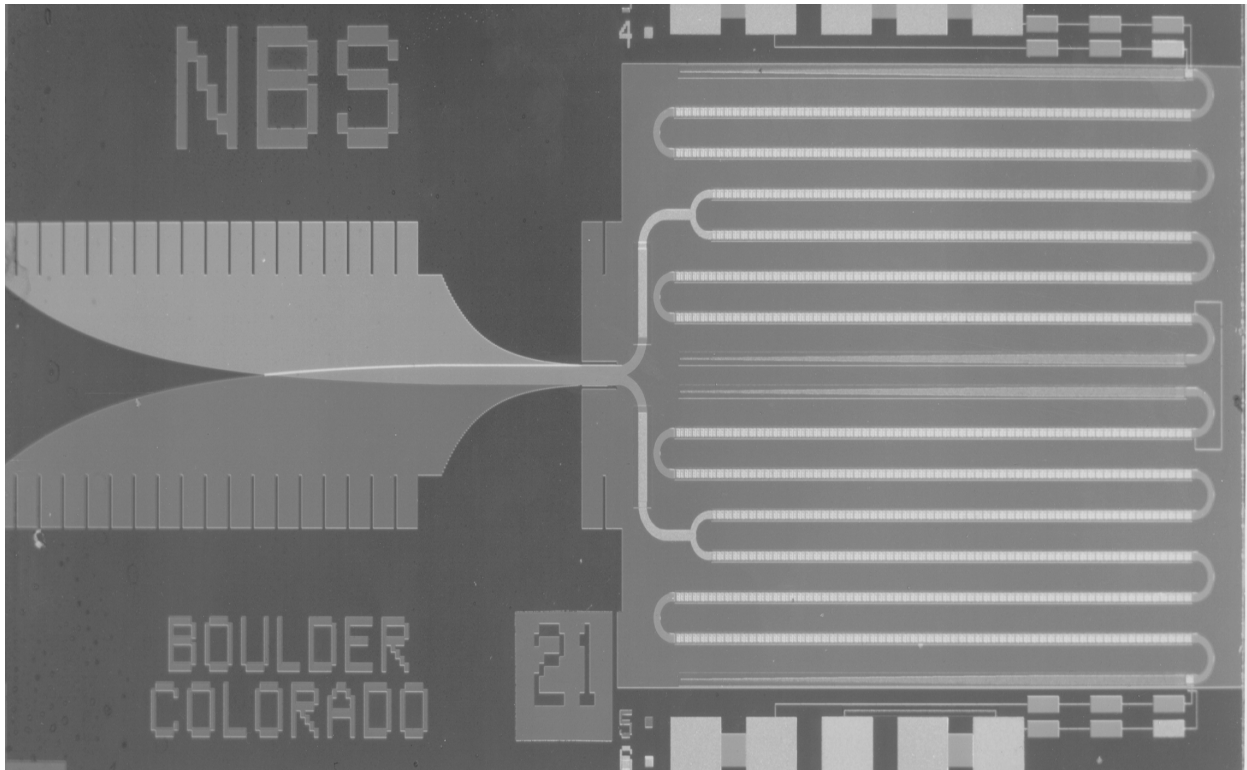

Fig. 1. One-volt NIST Josephson Junction array standard having 3020 junctions. The chip was designed and built by staff of the Electromagnetic Technology Division in Boulder in the cryoelectronic fabrication laboratory. It operates at liquid-helium temperatures; microwave energy is fed to four chains of junctions through the finguide structure at the left. The thin tapered structures at the end of each chain are terminations to prevent reflection of energy back up the chain.

artifacts that depend on bulk materials properties. There are approximately twenty industrial and military calibration laboratories throughout the United States that operate a JVS as a basis for traceable calibration measurements. The JVS consists of many cryogenic and microwave components, and each of these, as well as the environment and the user technique, can contribute uncertainty to the voltage measurement. Accordingly, it is necessary to make intercomparisons among independent JVS laboratories, to ensure the correctness of the measurements in these laboratories, just as it is at the international level. In 1991 NIST conducted the first JVS laboratory comparison experiment using transportable 10 V Zener standards, in which five other U.S. industrial and military laboratories participated [22]. Such comparisons are now carried out regularly under the auspices of the National Conference of Standards Laboratories, an industry trade association, with support from NIST as necessary.

Prepared by Y. Tang, N. B. Belecki, and J. F. Mayo-Wells based on excerpts from the paper The Ampere and Electrical Units [23], authored by members of the Electricity Division.

Bibliography

- [1] C. A. Hamilton, R. L. Kautz, R. L. Steiner, and Frances L. Lloyd, A Practical Josephson Voltage Standard at 1 V, *IEEE Electron Device Lett.* **EDL-6**, 623-625 (1985).
- [2] Clark A. Hamilton, Frances L. Lloyd, Kao Chieh, and Wayne C. Goeke, A 10-V Josephson Voltage Standard, *IEEE Trans. Instrum. Meas.* **38**, 314-316 (1989).
- [3] R. L. Kautz and Frances L. Lloyd, Precision of Series-Array Josephson Voltage Standards, *Appl. Phys. Lett.* **51**, 2043-2045 (1987).
- [4] Frances L. Lloyd, Clark A. Hamilton, J. A. Beall, Diane Go, R. H. Ono, and Richard E. Harris, A Josephson Array Voltage Standard at 10 V, *IEEE Electron Device Lett.* **EDL-8**, 449-450 (1987).
- [5] Clark A. Hamilton, Richard L. Kautz, Frances L. Lloyd, Richard L. Steiner, and Bruce F. Field, The NBS Josephson Array Voltage Standard, *IEEE Trans. Instrum. Meas.* **IM-36**, 258-261 (1987).
- [6] R. L. Kautz, C. A. Hamilton, and Frances L. Lloyd, Series-Array Josephson Voltage Standards, *IEEE Trans. Magn.* **MAG-23**, 883-890 (1987).
- [7] C. A. Hamilton, R. L. Kautz, and Frances L. Lloyd, The NBS Josephson Array Voltage Standard, in *CPEM 86 Digest: 1986 Conference on Precision Electromagnetic Measurements*, June 23-27, 1986, National Bureau of Standards, Gaithersburg, MD, Ronald F. Dziuba, (ed.), Institute of Electrical and Electronics Engineers, New York (1986) pp. 108-109.

- [8] C. A. Hamilton, F. L. Lloyd, and R. L. Kautz, A Josephson Series Array Voltage Standard at One Volt, in *Proceedings of the NCSL Workshop and Symposium*, July 15-18, Boulder, CO, (1985) pp. 71-77.
- [9] F. B. Silsbee, *Establishment and Maintenance of the Electrical Units*, NBS Circular 475, National Bureau of Standards, Washington, DC (1949).
- [10] Walter J. Hamer, *Standard Cells—Their Construction, Maintenance, and Characteristics*, NBS Monograph 84, National Bureau of Standards, Washington, DC (1965).
- [11] R. L. Driscoll and P. T. Olsen, Application of nuclear resonance to the monitoring of electrical standards, in *Precision Measurement and Fundamental Constants*, D. N. Langenberg and B. N. Taylor (eds.), NBS Special Publication 343, National Bureau of Standards, Washington, DC (1971) pp. 117-121.
- [12] W. G. Eicke, Commentaires sur l'utilisation des diodes de zener comme étalons de tension, Comité Consultatif d'Électricité, 11e Session, BIPM, Paris, France (1963) pp. 1874-1877.
- [13] W. H. Parker, D. N. Langenberg, A. Denenstein, and B. N. Taylor, Determination of e/h , using macroscopic quantum phase coherence in superconductors: I. Experiment, *Phys. Rev.* **177**, 639-664 (1969).
- [14] B. N. Taylor, W. H. Parker, D. N. Langenberg, and A. Denenstein, On the use of the ac Josephson effect to maintain standards of electromotive force, *Metrologia* **3**, 89-98 (1967).
- [15] F. K. Harris, H. A. Fowler, and P. T. Olsen, Accurate Hamon-pair potentiometer for Josephson frequency-to-voltage measurements, *Metrologia* **6**, 134-142 (1970).
- [16] B. F. Field, T. F. Finnegan, and J. Toots, Volt maintenance at NBS via $2e/h$: a new definition of the NBS volt, *Metrologia* **9**, 155-166 (1973).
- [17] Woodward G. Eicke and Barry N. Taylor, Summary of international comparisons of as-maintained units of voltage and values of $2e/h$, *IEEE Trans. Instrum. Meas.* **IM-21**, 316-319 (1972).
- [18] Barry N. Taylor, History of the present value of $2e/h$ commonly used for defining national units of voltage and possible changes in national units of voltage and resistance, *IEEE Trans. Instrum. Meas.* **IM-36**, 659-664 (1987).
- [19] R. L. Kautz, Noise, chaos, and the Josephson voltage standard, *Rep. Prog. Phys.* **59**, 935-992 (1996).
- [20] J. Niemeyer, L. Grimm, W. Meier, J. H. Hinken, and E. Vollmer, Stable Josephson reference voltages between 0.1 and 1.3 V for high-precision voltage standards, *Appl. Phys. Lett.* **47**, 1222-1223 (1985).
- [21] Richard L. Steiner and Bruce F. Field, Josephson array voltage calibration system: operational use and verification, *IEEE Trans. Instrum. Meas.* **38**, 296-301 (1989).
- [22] R. L. Steiner and S. Starley, MAP voltage transfer between 10 V Josephson array systems, in *Proceedings of the NCSL Workshop and Symposium NCSL'91*, Natl. Conf. Stand. Lab., Boulder, CO (1991) pp. 205-209.
- [23] R. E. Elmquist, M. E. Cage, Y. Tang, A-M. Jeffery, J. R. Kinard, R. F. Dziuba, N. M. Oldham, and E. R. Williams, The Ampere and Electrical Units, *J. Res. Natl. Inst. Stand. Technol.*, January-February (2001).

Plane-Wave Scattering-Matrix Theory of Antennas and Antenna-Antenna Interactions

This monograph [1] represents David Kerns's final compilation on the subject of near-field antenna measurements. It was published shortly before he retired, and it remains the best and most exhaustive treatment of planar near-field scanning theory. The author developed much of the material in the course of teaching graduate electrical engineering courses in the University of Colorado.

As outlined in the author's preface, the monograph is distinguished by the use of plane-wave spectra for the representation of fields in space and by the consideration of antenna-antenna (and antenna-scatterer) interactions at arbitrary separation distances. The plane-wave representation is eminently suitable for this purpose as well as for the expression of conventional asymptotic quantities of antenna theory, such as power gain, effective area, and polarization.

The primary objective of the monograph is to facilitate the critical acceptance and proper application of antenna and field measurement techniques deriving more or less directly from the plane-wave scattering-matrix (PWSM) theory of antennas and antenna-antenna interactions. A secondary objective is to present

some recent and some new theoretical results based on this theory. To some extent the second objective supports the first one.

The expository plan is based upon experience at NBS in developing, discussing, teaching, and reporting on the PWSM theory and techniques, as well as upon observing at close hand the development of major NBS facilities for practical antenna measurement applications. All field and antenna measurements involve measurements of antenna outputs and inputs. This part of the total process is the approximate dividing line between the domain of antenna theory and the domain of microwave measurement techniques including instrumentation. Or perhaps instead of a dividing line there is a gap or crevice.

Elaborate measurements made on expensive antennas with expensive measuring equipment can be (and have been) vitiated by improper microwave network calculations or by improper adjustments due to improper interpretation of impedance-matching requirements. This is in part a reflection of omitted, inadequate, or even incorrect discussions of relatively simple network calculations in the literature.

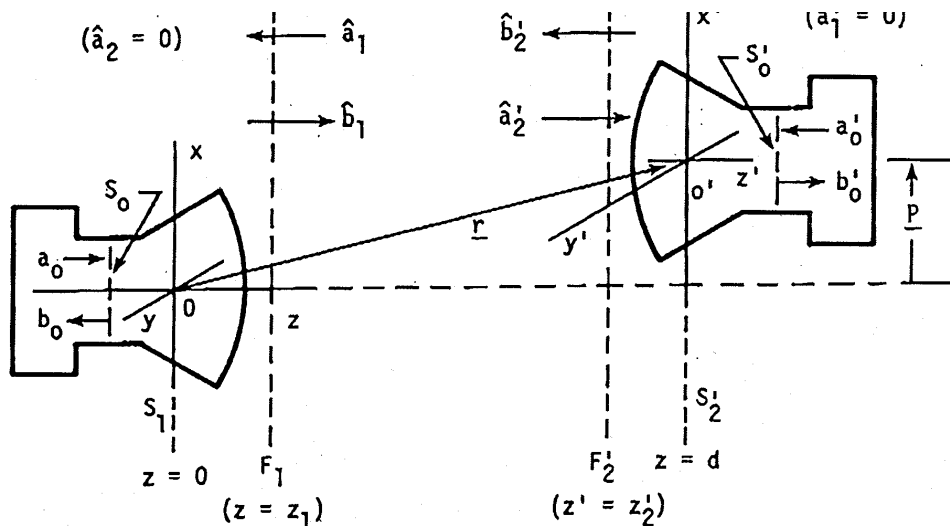

Fig. 1. The figure provides a hint of the complexity of the analyses addressed in the monograph. It represents a pair of antenna systems operating in a homogeneous, isotropic, dissipationless medium; one antenna is transmitting, and the other receiving. The complete treatment of a transmission system must include effects of scattering by both antennas and thus automatically includes treatment of reflection systems, in which one antenna functions in both transmitting and receiving modes and the other antenna represents an arbitrary passive (linear) scattering object.

One quantity, characteristic of the type of antenna measurements of interest here, is the transfer normalization required to obtain the ratio of receiving antenna output to transmitting antenna input correctly in magnitude and relative phase. This normalization, even if done correctly with good instruments and good technique, may represent the single largest contribution to the inaccuracy or uncertainty of the eventually determined antenna or field data. In short, to be able to make good microwave antenna measurements, one must be able to make good microwave measurements. This is true regardless of the brand of antenna theory that one uses.

The theoretical basis and the techniques of microwave network calculations receive little or no emphasis in most books on electromagnetic theory and, apparently, surprisingly little in the training and background of microwave and microwave-antenna engineers. Chapter I of this monograph is intended to supply some of the missing emphasis. It consists of a revision and adaptation of part 1 of the book by Kerns and Beatty [2] with an added section giving basic microwave network equations selected and discussed with antenna measurement applications in mind. The general theoretical foundation provided in this chapter has an additional role in the present monograph.

The use of the plane-wave representation of the spatial fields (as contrasted to the use of spherical or cylindrical waves) simplifies and strengthens the theoretical analogy between an antenna and an ordinary waveguide junction (or N-port) described in terms of a finite number of discrete waveguide input or output modes, and it greatly simplifies the analogy between coupled antennas and coupled waveguide junctions.

Chapter I is intended to be concise as well as elementary, but it is elementary only with respect to its principal subject. The reader is assumed to have a good working acquaintance with Maxwell's equations, vector analysis, and elementary matrix algebra. Transmission-line theory may be underrepresented in the discussion, but the use of the traveling-wave resolution of fields more or less automatically takes care of the need for transmission-line equations.

Chapter II gives a formulation of the PWSM theory of antennas and antenna-antenna interactions together with basic analytical techniques for measurement applications. The formulation is relatively thorough and complete, whereas the measurement techniques are treated briefly. The reason for this imbalance is that the measurement techniques are acquiring their own literature, to which references are given. Chapter II contains all of the material in the previous most complete discussion of the PWSM theory [3] with revisions to improve the exposition. The bias is toward the subject of measurements as an end and not merely as a means,

with emphasis on accurate measurements, or at least measurements with controlled approximations. Both generality and detail are required to avoid over-idealization, to permit the framing of precise definitions, and to permit cognizance and the possibility of control of approximations. Less general theorems and simplified formulas might improve appearances of the pages of the monograph, but would tend to be much less convenient and useful to a measurement-oriented person interested in accurate measurements. It is much easier to reduce, than to increase, the generality of a given set of equations.

The generality of the PWSM formulation is such that it is not necessary to single out any particular types or classes of antennas for purposes of discussion of measurement equations. The measurement related theorems and equations are valid for arbitrary types of antennas, such as the so-called linear antennas, aperture antennas, and arrays of antenna elements.

The third and last chapter is in essence a rather lengthy research paper. It relies upon the first three of the four sections of Chapter II for definitions, theorems, and motivation; in turn, the analytical results obtained in Chapter III support and illustrate Chapter II.

The use of examples is a feature of the exposition (38 numbered examples are included, most of them in Chapter III). The examples serve several purposes: the rederivation or restatement of certain well-known results in the PWSM format is expected to lend perspective, establish confidence, and show some of the connections to existing theory. Examples are used to provide extensions of the text material not readily available elsewhere and to form part of the development of the subject. Most of the examples are suitable as material for exercises (but so also are many equations and assertions for which detailed argument is not given).

Kern's ground breaking 1960 paper [4] on the *Theory of diffraction in microwave interferometry* was the seminal work that marks the beginning of modern near-field antenna metrology. Under the leadership of Kerns and other pioneers at NBS, near-field techniques have become the preferred methods for characterizing the radiating properties of microwave antennas. In addition to the well-known NIST antenna group, several universities maintain active near-field measurement research programs. Half a dozen companies market near-field scanning equipment and well over 200 laboratories worldwide routinely perform near-field measurements. The IEEE Antennas and Propagation Society has published a special issue (*IEEE Transactions on Antennas and Propagation, June 1988*) and regularly features sessions on near-field techniques at its conferences.

Prepared by A. G. Repjar and J. F. Mayo-Wells.

Bibliography

- [1] David M. Kerns, *Plane-Wave Scattering-Matrix Theory of Antennas and Antenna-Antenna Interactions*, NBS Monograph 162, National Bureau of Standards, Washington, DC (1981).
- [2] David M. Kerns and Robert W. Beatty, *Basic Theory of Wave-guide Junctions and Introductory Microwave Network Analysis*, Pergamon Press, Oxford (1967) p. 29 ff.
- [3] David M. Kerns, Plane-wave scattering-matrix theory of antennas and antenna-antenna interactions: formulation and applications, *J. Res. Natl. Bur. Stand.* **80B**, 5-51 (1976).
- [4] D. M. Kerns and E. S. Dayhoff, Theory of diffraction in microwave interferometry, *J. Res. Natl. Bur. Stand.* **64B**, 1-13 (1960).

The Automated Manufacturing Research Facility

Over the years, NBS/NIST has built various experimental facilities to support its assigned functions of custody, maintenance, and development of national measurement standards, and provision of the means and methods for making measurements consistent with those standards. Such facilities include a nuclear reactor, a cold neutron source, a linear accelerator, a fire research facility, and dead weight force generators. It was in this tradition that the Automated Manufacturing Research Facility (AMRF) was established. The AMRF was designed to anticipate the measurement and standards needs of the discrete parts manufacturing industry in the 1990s and beyond. This 1982 paper [1] describes the history of NBS efforts to meet the measurement needs of U.S. manufacturing industries, beginning with artifact standards and calibrations during the first half of the century, and evolving to measurement protocols based on laser interferometer calibrations of coordinate measuring machines by the 1960's. The paper also describes early work in control system architectures that provided the basis for the AMRF research in interface standards for information exchange within computer-based manufacturing systems.

During the 1970s, two significant trends had become clear:

- 1) Computers were playing an increasingly important role in manufacturing.
- 2) Measurements were increasingly integrated into the closed-loop control of machines and processes.

The first trend meant that interface standards would be needed to facilitate exchange of information between computer systems. The second meant that in-process measurement technology would be needed for real-time feedback control. To address interface standards, the AMRF focused on developing information exchange requirements and a reference model architecture to understand the interactions between components of computer-based manufacturing systems. To address the in-process measurement issues, the AMRF focused on methods for instrumenting machines and integrating measurements into the machining process. Inspection would be performed on-line while parts were being manufactured, in addition to, or instead of, off-line after the fact.

Prior to the 1970s, most measurements of manufactured products were based on artifact standards such as gage blocks, thread gages, and line scales. NBS supported industry by providing calibrations that tied these artifacts to national and international standards of length. Industry compared their manufactured products with these artifact standards by statistical quality control methods. Products were typically inspected off-line after the manufacturing process had been completed.

During the 1960s and 1970s, the concept of Measurement Assurance Programs began to emphasize the system aspects of measurement. Coordinate measuring machines (CMMs) were introduced into the inspection process and closed loop feedback methods became part of metrology management. CMMs increased the reliability with which comparison with artifacts could be accomplished and improved productivity by reducing the time required to make measurements. Of course, coordinate measuring machines were themselves subject to errors that were consequently introduced into the measurement process. However, these errors were in large part systematic. Simpson and Hocken observed that a typical coordinate measuring machine was an order of magnitude more repeatable than it was accurate [2]. This suggested that if the systematic errors were modeled and stored in a computer, then the computer could compensate for those errors. During the 1970s, NBS work in calibration and computer correction of coordinate measuring machine errors made a significant contribution to measurement technology for manufacturing [3]. The concept of in-process measurement and computer based error compensation also provided the conceptual foundation for the AMRF approach to measurement technology.

Also during the 1970s, NBS work in robotics and neural networks began to address issues of intelligent control. The goal of this research was to bridge the gap between high level concepts of artificial intelligence (such as perception, knowledge representation, and planning) and low level concepts of feedback control. The approach was to develop a system architecture that could support the decomposition of high level manufacturing tasks into lower level subtasks in a succession of hierarchical steps until, at the bottom, subtask commands could be input directly to servo control loops. At each level of the hierarchy, signals from sensors were processed to extract the information needed for

real-time control decisions at that level. This sensory-interactive goal-directed control architecture became known as the Real-time Control System (RCS.) RCS was intended to be a reference model architecture with a canonical form that could be used to define standard interfaces between modular components [4].

Concurrent with the development of RCS, work was begun on interface standards to facilitate exchange of information between various commercial Computer-Aided Design (CAD) systems. Under the technical leadership of Roger Nagel and Bradford Smith, the Initial Graphics Exchange Specification (IGES), which is described elsewhere in this volume, became a national standard. IGES was an immediate success. Within a few years, virtually all manufacturers of CAD systems

provided IGES interfaces for their systems [5]. Together, the RCS control architecture and the IGES data exchange standard provided the conceptual foundation for the AMRF work on interface standards [6]. Fig. 1 is a diagram of the AMRF control system architecture.

AMRF consisted of six workstations integrated into a group technology cell. Orders were input through cell control [7]. (The shop control shown in Figure 1 was never implemented.) There were three machining workstations, a cleaning and deburring workstation, an inspection workstation, and a material handling workstation. Part designs and process plans were developed interactively by human programmers off-line. A management information system provided information about the status of the factory [8, 9, 10].

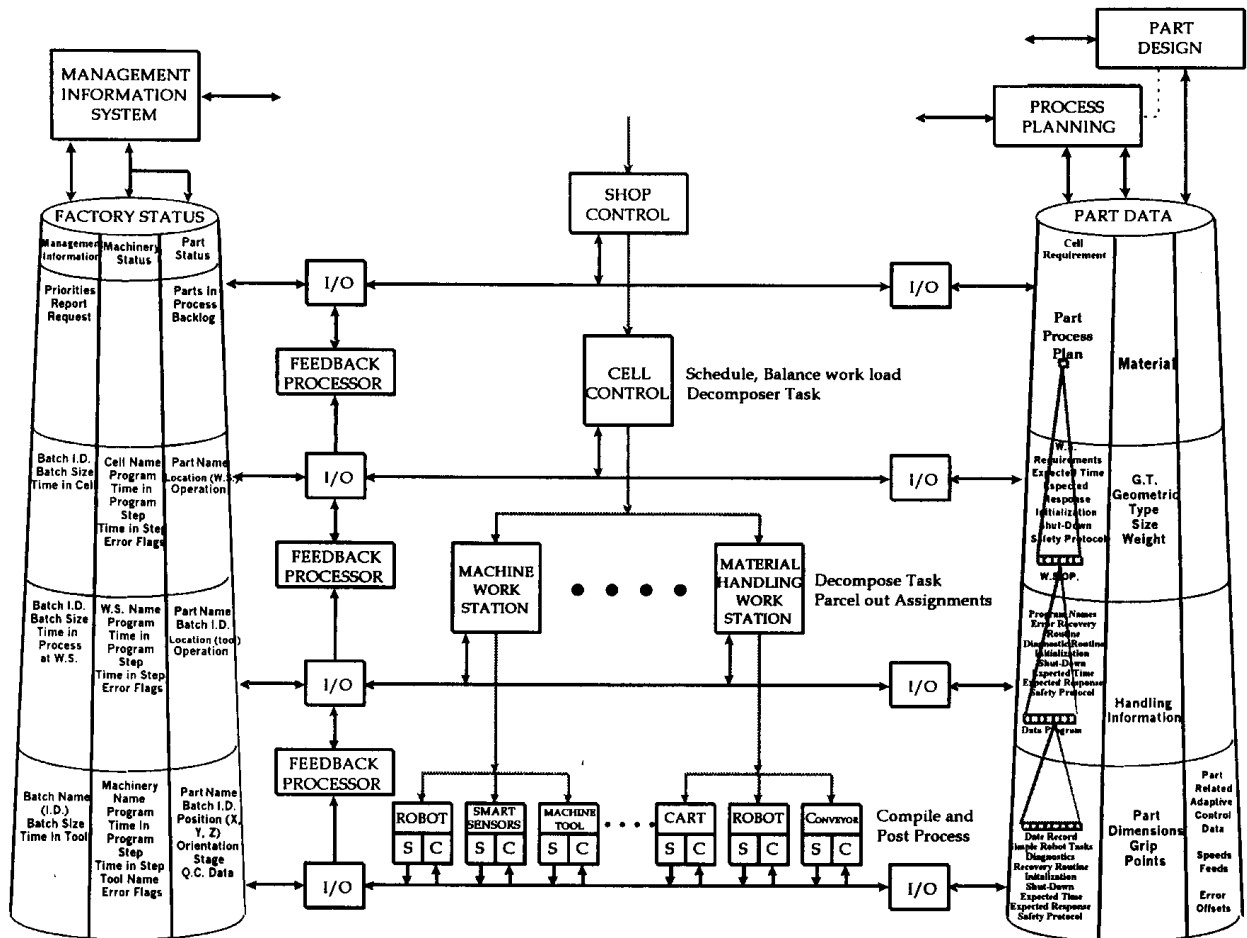

Fig. 1. Architecture for the NBS Automated Manufacturing Research Facility (AMRF). On the right is a hierarchical database containing process plans and control programs that define how to manufacture parts. On the left is a hierarchical database containing information about the state of the parts and machines in the AMRF. In the middle are the controllers that compute plans, sequence commands, measure results, and compute actions to compensate for errors between plans and results. The arrows represent a communications system that moves information throughout the architecture [1].

The six workstations included the:

1) *Horizontal Machining Workstation*

The major subsystems of the HWS included a horizontal spindle milling machine, a robot, and a set of buffers. The machine tool was equipped with a tool changer, a pallet shuttle, and an automatic vise for holding parts. The buffers were used to store tools, parts, and fixtures. They were serviced by an automatic wire-guided vehicle. All of the HWS subsystems were coordinated by the RCS workstation controller. The robot, machine tool, buffer, and automatic fixture were also equipped with RCS control systems that enabled them to accept commands from the workstation controller. The robot had vision and tactile sensors that enabled it to sense the position and orientation of parts and tools, and to load and unload them to and from the machine tool. The robot vision system used structured light to detect the three-dimensional position and orientation of parts in a buffer tray and to measure their size and shape. Tactile sensing enabled the robot to “feel” a part being grasped and to sense when it had been properly inserted into a fixture for machining. The HWS robot had the dexterity to remove a part from the fixture, turn it over, and re-insert it for machining the opposite side. It could also load tools into the machine’s tool carousel. The robot was equipped with a quick-change wrist so that different grippers for different shaped parts and tools could be handled. The RCS controllers, each typically consisting of several computers on a bus, were integrated through an experimental AMRF network and database [11, 12, 13].

2) *Vertical Machining Workstation (VWS)*

The VWS consisted of a vertical spindle milling machine, a robot, and a menu-driven programming system whereby parts could be designed and machined automatically from a feature-based design. A simple two-and-a-half dimensional part could be designed and machined within an hour, allowing half an hour for design input. Workstation activity was divided into design, process planning, data execution, and physical execution stages. To make VWS operation safe and accurate, extensive error prevention and verification procedures were incorporated in the data preparation stages. Automatic verification included design editor dialogues, design enhancement, design verification, process plan verification, work-piece verification, and part model checking. Interactive verification included design drawing, work-piece model drawing, and tool path drawing [14, 15, 16].

3) *Turning Workstation (TWS)*

The major components of the TWS included a turning lathe, a robot to load and unload parts and tools, and buffers to store parts, tools, and fixtures. The TWS was equipped with position sensors, accelerometers, thermal sensors, and laser interferometers. A special purpose gripper was developed with a micro-manipulator that enabled the robot to perform high precision insertions required for loading parts in the lathe collet. The Turning Workstation addressed problems associated with untended turning operations. These included automatic tool changing, work piece loading and unloading, and tool setting. The TWS enhanced the accuracy of the turning lathe by real-time software error compensation. Thermally induced errors were predicted based on calibration and measurement of machine position, direction of motion, and temperature profile. During machining, predicted errors were compensated by machine servo algorithms. Software error correction improved overall machine accuracy by about an order of magnitude [17].

4) *Inspection Workstation (IWS)*

The IWS contained a four-axis coordinate measuring machine, a robot, and a variety of inspection probes for measuring part dimensions and surface finish. Parts were delivered to the IWS by automatic wire-guided vehicles. They were loaded onto the coordinate measuring machine by the robot and inspected. Measurements were compared against dimensions and tolerances in the part design data. Statistics were kept on dimensions within tolerance so that machining operations could be adjusted to maintain quality. Dimensions outside of tolerance were flagged. Surface finish data was also collected [18].

5) *Cleaning and Deburring Workstation (CDWS)*

The CDWS consisted of two robots, a set of buffing wheels, a set of deburring tools, a part holding fixture, a washer/dryer, and a storage buffer. Both robots had integrated force/torque sensors that enabled them to sense forces and modify their motions so as to correct for small errors and tool wear. One robot performed buffing operations. The second had a tool changer that enabled it to use a variety of abrasive brushes and deburring tools. The CDWS controller had a computer-aided programming system that enabled an operator to select tool orientation, force, and speed parameters for each deburring operation. The system then automatically generated a control program for the tool path and

manipulation operations necessary to load each part into a fixture and perform the specified set of deburring operations [19, 20].

6) *Material Handling Workstation (MHWS)*

The MHWS workstation consisted of a part and tool storage carousel, a storage and retrieval system, an automatic wire-guided delivery cart, and a workstation controller. The storage carousel had sufficient capacity for one week of operation. The MHWS controller responded to requests by the other workstations for delivery and pickup of parts and tools. The MHWS planned a route and dispatched its delivery cart to the appropriate workstation at the proper time [21].

The AMRF also included three infrastructure support projects. These were the Integrated Manufacturing Data Administration System (IMDAS) [22], the AMRF Network Communications system [23, 24], and the Hierarchical Control System Emulator [25]. IMDAS provided the database management services necessary to store and retrieve the control programs that specify how to manufacture each part, and the part data files that specify geometry and tolerances for each part feature. The Network Communications system provided the data transmission services required to support the AMRF control system architecture. The control system emulator enabled programmers to develop software in a virtual environment. Control programs could be tested and debugged on emulated machines that were indistinguishable from real machines to the control system software.

During its lifetime, several thousands of people visited the AMRF and explored with its scientists and engineers issues of concern to their companies. Examples of the comments received from industrial visitors are:

“The AMRF provides a good architecture for factory automation which we are using in our internal factory automation program. We are picking up a lot of concepts such as feedback loops, world modeling, and planning. We are developing a generic cell based on the AMRF architecture.” [26].

Mr. Bob Solberg, Chairman,
Factory Automation Council
Boeing Computer Services,
Boeing Company

In 1984 I joined the Aircraft Engine Group of General Electric as the Manager of Automation for a flexible turning center to be built in Lynn, MA. The NBS/AMRF hierarchical control structure was one of the models we used in designing the computerized control system for that plant. More than this, the AMRF provided us with a reference, something we could check ourselves against. Some of the things being done at the AMRF are profound in my view. For example, AMRF researchers introduced error maps to facilitate the use of computer-based temperature correction to upgrade the precision of a milling machine.” [26].

Mr. Robert D. French, Manager
T700/CT7 Engine Programs
General Electric Company,
Aircraft Engine Business Group

Over the years, technology from the AMRF was transferred into industrial production. As a follow-on to the AMRF Turning Workstation, NBS researchers designed and built a flexible manufacturing workstation for the Mare Island Naval Shipyard. The Mare Island workstation was developed to manufacture a family of 40 different pipe connectors designed to inhibit the transmission of sound in nuclear submarines. The workstation was equipped with an NC lathe, live tooling, a robot, an automated storage and retrieval system, and an AMRF style control system. It was designed to work unattended. Previous manual techniques required 17 hours to produce a typical part. The new workstation could manufacture the same part in as little as 20 minutes.

Lessons learned from the Mare Island workstation were put into practice in another version of the AMRF Turning Workstation built for the Portsmouth Naval Shipyard. The Portsmouth workstation was designed to manufacture and inspect class-1 fasteners (i.e., critical bolts, studs, and cap screws) for nuclear submarines. These fasteners were made of k-monel, a very strong, corrosive-resistant metal that is difficult to machine. Personnel from the Portsmouth shipyard worked closely with NIST scientists to make the technology transfer successful [27].

The RCS control system architecture developed for the AMRF was adapted for use in several areas outside of manufacturing. Under DARPA funding, RCS was

adapted for control of multiple autonomous undersea vehicles. DARPA also supported the adaptation of RCS for command and control systems aboard next generation nuclear submarines. The U.S. Bureau of Mines adopted RCS as an architecture standard for automated mining operations. RCS was adopted by the U.S. Postal System for control of a stamp distribution center and a general mail facility. NASA adopted a version of RCS called NASREM (NASA/NBS Reference Model) as a controller for the Space Station telerobotic servicer. NASREM was also adopted by the European Space Agency as a model for their robotics program. For the past ten years, RCS has been used by the Army for their research program in Unmanned Ground Vehicles [28]. The Air Force Next Generation Controller program and the industry led Open Modular Architecture Control (OMAC) consortium have been influenced by the AMRF control architecture.

Among the long term results of the AMRF was the influence it had on the transformation of NBS to NIST. According to a report by the National Academy of Sciences [29]:

“The AMRF served as a platform to develop needed technology for flexible, integrated, and automated manufacturing of discrete parts. Originally conceived as a testbed for integration of advanced automation, it successfully proved a number of concepts and eliminated less promising ones. It has played a significant role in the identification and development of emerging technologies in manufacturing. It has had considerable influence on various private efforts throughout the nation. It was also the catalyst for the legislative process that resulted in the Technology Competitiveness Act” (the section of the Omnibus Trade Act of 1988 which reauthorized NBS and NIST.)”

Besides changing the name from NBS to NIST, the Trade Act added two new programs to the NIST responsibilities: The Advanced Technology Program (ATP), and the Manufacturing Technology Centers (MTC) which became the Manufacturing Extension Partnership (MEP.) The MTC program was originally conceived as a mechanism for transferring manufacturing technology from the AMRF to industry.

The AMRF was jointly funded by NBS and the Navy Manufacturing Technology Program. The program managers for the Navy were Jack McInnis and Steve Linder. The number of people involved in the AMRF is much too large to give proper credit to everyone by name or to cite every related publication. The bibliography gives a sampling of the more significant publications.

Prepared by James S. Albus.

Bibliography

- [1] J. A. Simpson, R. J. Hocken, and J. S. Albus, The Automated Manufacturing Research Facility of the National Bureau of Standards, *J. Manuf. Syst.* **1**, 17-32 (1982).
- [2] John A. Simpson, Mechanical Measurement and Manufacturing, in *Control and Dynamic Systems: Advances in Theory and Applications, (Manufacturing and Automation Systems: Techniques and Technologies, Vol. 45)*, Richard H. F. Jackson and C. T. Leondes, (eds.), Academic Press, San Diego (1992) pp. 17-30.
- [3] M. A. Donmez, D. S. Blomquist, R. J. Hocken, C. R. Liu and M. M. Barash, A General Methodology for Machine Tool Accuracy Enhancement by Error Compensation, *Precis. Eng.* **8**, 187-196 (1986).
- [4] Anthony J. Barbera, M. L. Fitzgerald, James S. Albus, and Leonard S. Haynes, RCS: The NBS Real-Time Control System, in *Robots 8: Conference Proceedings, Vol. 2*, Detroit, Michigan, June 1984, Society of Manufacturing Engineers, Dearborn, MI (1984) pp. 19-1 – 19-33.
- [5] Bradford Smith, Gaylen R. Rinaudot, Kent A. Reed, and Thomas Wright, *Initial Graphics Exchange Specification (IGES) Version 4.0*, NBSIR 88-3813, National Bureau of Standards, Gaithersburg, MD (1988).
- [6] James S. Albus, Anthony J. Barbera, M. L. Fitzgerald, Ernest Kent, Harry Scott, and Roger Kilmer, A Control System for an Automated Manufacturing Research Facility, in *Robots 8: Conference Proceedings, Vol. 2*, Detroit, MI, June 1984, Society of Manufacturing Engineers, Dearborn, MI (1984) pp. 13-28–13-44.
- [7] C. R. McLean, *A Cell Control Architecture for Flexible Manufacturing*, SME Technical Paper MS88-473, SME Cell Controllers Clinic, Schaumburg, Illinois, April 26-27, 1988.
- [8] J. S. Albus, C. R. McLean, A. J. Barbera, and M. L. Fitzgerald, An Architecture for Real-Time Sensory-Interactive Control of Robots in a Manufacturing Facility, in *Proceedings of the Fourth IFAC/IFIP Symposium on Information Control Problems in Manufacturing Technology*, Gaithersburg, Maryland, October 1982, pp. 81-90.
- [9] Mary Mitchell, Yuhwei Yang, Steve Ryan, and Bryan Martin, *Data Model Development and Validation for Product Data Exchange*, NISTIR 90-4241, National Institute of Standards and Technology, Gaithersburg, MD, January 1990.
- [10] Albert T. Jones and Charles R. McLean, A Proposed Hierarchical Control Model for Automated Manufacturing Systems, *J. Manuf. Syst.* **5**, 15-25 (1986).
- [11] Albert J. Wavering and John C. Fiala, *The Real-Time Control System of the Horizontal Workstation Robot*, NBSIR 88-3692, National Bureau of Standards, Gaithersburg, MD, December 1987.
- [12] W. G. Rippey and H. A. Scott, Real-time Control in a Machining Workstation, in *Proceedings of the 20th Annual Meeting and Technical Conference, Numerical Control Society*, Cincinnati, Ohio, April 10-13, 1983, Numerical Control Society, Glenview, IL (1983).
- [13] Harry Scott and Kathleen Strouse, Workstation Control in a Computer Integrated Manufacturing System, in *Autofact 6: Conference Proceedings*, Anaheim, CA, October 1984, Society of Manufacturing Engineers, Dearborn, Michigan (1984) p. 22.
- [14] T. R. Kramer and J. Jun, Software for an Automated Machining Workstation, in *Proceedings 3rd Biennial International Machine Tool Tech Conference*, September 1986.

- [15] T. R. Kramer, Process Planning for a Milling Machine from a Feature-Based Design, in *Proceedings of Manufacturing International '88*, Atlanta, Georgia, April 1988, ASME Vol. III, American Society of Mechanical Engineers, New York (1988) pp. 179-189.
- [16] T. R. Kramer and W. T. Strayer, Error Prevention and Detection in Data Preparation for a Numerically Controlled Milling Machine, in *Proceedings of 1987 ASME Annual Meeting, (ASME PED Vol. 25)*, American Society of Mechanical Engineers, New York (1987) pp. 195-213.
- [17] Alkan M. Donmez, Robert J. Gavin, Lew Greenspan, Kang B. Lee, Vincent J. Lee, James P. Peris, Eric J. Reisenauer, Charles O. Shoemaker, and Charles W. Yang, *The Turning Workstation in the AMRF*, NBSIR 88-3749, National Bureau of Standards, Gaithersburg, MD (1988).
- [18] Howard T. Moncarz, *Architecture and Principles of the Inspection Workstation*, NBSIR 88-3802, National Bureau of Standards, Gaithersburg, MD (1988).
- [19] H. G. McCain, R. D. Kilmer, and K. N. Murphy, Development of a Cleaning and Deburring Workstation for the AMRF, in *Deburring and Surface Conditioning '85: Conference Proceedings*, September 23-26, 1985, Chicago, Illinois, Society of Manufacturing Engineers, Dearborn, Michigan (1985).
- [20] F. M. Proctor, K. N. Murphy, and R. J. Norcross, Automating Robot Programming in the Cleaning and Deburring Workstation of the AMRF, in *Deburring and Surface Conditioning '89*, San Diego, CA, February 1989, Society of Manufacturing Engineers, Dearborn, Michigan (1989).
- [21] S. Szabo, M. Juberts, and R. D. Kilmer, Automated Guided Vehicles at the National Bureau of Standards Automated Manufacturing Research Facility, *Journal of Unmanned Vehicle Systems*, pp. 38-47, Summer 1984.
- [22] D. Libes and E. Barkmeyer, The Integrated Manufacturing Data Administration System (IMDAS)—An Overview, *Int. J. Comput. Integr. Manuf.* **1**, 44-49 (1988).
- [23] Siegfried Rybczynski, Edward J. Barkmeyer, Evan K. Wallace, Michael L. Strawbridge, Don E. Libes and Carol V. Young, *AMRF Network Communications*, NBSIR 88-3816, National Bureau of Standards, Gaithersburg, MD (1988).
- [24] Charles McLean, Mary Mitchell, and Edward Barkmeyer, A Computer Architecture for Small-Batch Manufacturing, *IEEE Spectrum* **20** (5), 59-64 (1983).
- [25] Howard M. Bloom, Cita M. Furlani, and Anthony J. Barbera, Emulation as a Design Tool in the Development of Real-Time Control Systems, in *1984 Winter Simulation Conference Proceedings*, Dallas, Texas, November 28-30, 1984, Institute of Electrical and Electronics Engineers, New York (1984) pp. 627-636.
- [26] W. P. Meade, *The National Bureau of Standards' Automated Manufacturing Research Facility (AMRF)—A Manufacturing Technologies Resource Center*, Management Collaborative Group, Chapel Hill, NC (1988).
- [27] K. B. Lee, *Computer-Controlled Fastener Manufacturing Workstation*, Technical Paper Series 941719, Society of Automotive Engineers, Warrendale, PA (1994).
- [28] J. S. Albus, The NIST Real-time Control System (RCS): An Application Survey, in *Proceedings of the AAI 1995 Spring Symposium Series*, Stanford University, Stanford, CA, March 27-29, 1995.
- [29] *An Assessment of the National Institute of Standards and Technology Programs, Fiscal Year 1990*, National Academy Press, Washington, DC (1991).

Submicrometer Linewidth Metrology

In 1987, the semiconductor industry was undergoing a technological transition into the submicrometer range of device dimensions. Small dimensions that are very important to device performance or yield are called critical dimensions (CD). Optical metrology technology was adequate to measure the critical dimensions above 1 μm , but as these dimensions shrunk into the submicrometer regime, the industry felt that the development of a new technology would be necessary. Scanning electron microscopy began to be employed as the new “tool” to measure submicrometer structures. In an effort to assist the industry in this transition, two papers were published in the same issue of the NBS *Journal of Research* summarizing the knowledge on optical metrology at that time. These papers discussed the capabilities for extension into the submicrometer regime and reported on the promising scanning electron microscopy and its potential to take over from optical metrology. The two pioneering review papers, *Submicrometer Linewidth Metrology in the Optical Microscope* [1] by Diana Nyssonen and Robert Larrabee, and *Submicrometer Microelectronics Dimensional Metrology: Scanning Electron Microscopy* [2] by Michael T. Postek and David C. Joy, helped to reorient the metrology direction of the semiconductor industry, with impacts being felt even today.

By the year 1987 optical microscopes had been used for looking at small things for several centuries and had been optimized for this purpose. However, they were not optimized for accurate dimensional metrology in the submicrometer regime. Scanning electron microscopes had also been used for looking at small things, but only for decades instead of centuries. They also were not optimized for submicrometer dimensional metrology. Accurate measurements of submicrometer dimensions in both kinds of microscopes were more difficult to make and interpret than was generally recognized at that time.

These two back-to-back papers [1,2] served to clarify a number of misconceptions by those in industry who were actually manufacturing the microscopes or using them to make critical submicrometer dimensional measurements. Both papers were aimed directly at submicrometer measurements for quality control purposes in the semiconductor and magnetic-storage tape-head industries. An unusually large number of requests for reprints were received from readers in the United States, and the oral feedback revealed that the

papers were extensively faxed between colleagues in foreign countries. It is impossible to document the savings to industry due to the resulting improvements in quality control attributable to these papers because quality control information is often considered proprietary. Anecdotal feedback at subsequent technical meetings and during the authors’ visits to industry clearly indicated that material in the papers was important and that the savings were substantial.

As the dimensions of interest continued to shrink in the years following publication, these papers helped set the stage: 1) for the improvements in the basic instrumentation used for optical and SEM metrology, 2) for the motivation to develop theoretical models for interpretation of such measurements, and 3) for the more intelligent use of the resulting measurement data. The information in these papers is still relevant to submicrometer metrology even though much progress has occurred since their publication. They should still provide useful background information on micrometer and submicrometer measurements for new metrologists and for new, or more demanding, applications in the new millennium (e.g., for linewidth and overlay measurements in the semiconductor industry and for critical dimensions in tape-head, microfabrication, micromachining industries).

The submicrometer optical metrology paper [1] assessed the capabilities and limitations of optical submicrometer dimensional metrology and how well it would be able to meet the measurement needs of future semiconductor processing technologies (e.g., linewidth measurements). The fact that the wavelength of the commonly used visible light in the optical measuring tools was comparable to the feature sizes of interest led to serious limitations. The paper discussed the need to model mathematically the effects of diffraction in the image and thereby develop a meaningful criterion for deciding which point on the image corresponds to the edge of the feature whose dimensions were being measured. Nyssonen and Kirk developed such a model [4] and Nyssonen used that model for the calibration of NIST’s first photomask linewidth standards [5]. The modeling (and the measurement) is much more difficult for opaque specimens (e.g., silicon wafers) and becomes increasingly difficult as the feature heights become larger than about a quarter wavelength and as the aspect ratio (feature-height/width) approaches unity. These factors, plus the non-vertical edge shapes of the

features, severely compromised the accuracy of dimensional measurements in the submicrometer regime.

The general problem of optical linewidth metrology was discussed with emphasis on: 1) definition of linewidth for non-ideal features, 2) precision and accuracy (now referred to as Type 1 and Type 2 errors), 3) effects of measurement errors on process control, 4) instrument design, 5) resolution of the measuring microscope, 6) optical-based linewidth standards, and 7) alternative linewidth measurement techniques. The factors affecting measurements of small feature dimensions were discussed and illustrated by calculated image waveforms for a typical patterned polysilicon line on a silicon dioxide layer upon a silicon substrate. In these calculations the waveform changed as the silicon dioxide layer thickness was varied and the edge geometry of the line deviated from vertical. In addition, the different kinds of microscopes used in optical metrology were discussed and illustrative image profiles under various illumination conditions were presented.

Perhaps the main message of this paper was that submicrometer optical metrology was more difficult than commonly envisioned at the time and that many factors came into play that were often overlooked, ignored, or inadequately treated in practical applications. With the ongoing impetus of the semiconductor industry toward ever-smaller submicrometer dimensions at that time, this attitude had to change if the anticipated future needs for decreased measurement uncertainty and increased accuracy were to be met. This paper helped set the stage for the change that did, in fact, occur.

The scanning electron microscope used in low accelerating voltage mode was initially felt to be the panacea for the problems encountered by optical submicrometer metrology. The paper by Postek and Joy [2] demonstrated that, although the SEM was capable of precise measurements, accuracy was another issue altogether. It also pointed out a number of pitfalls associated with the instrument, making use of a simple micrograph of a dime (Fig. 2). This micrograph drove home the point that just because an image came from an SEM did not mean that it was an accurate representation. As important as it was to understanding the instrumental problems, this paper also pointed out that the main limitation of the SEM for accurate submicrometer metrology is the electron beam/sample interaction, which affects the generation and collection of the measured signals. This was the first paper to stress the need for understanding the electron beam/sample interaction as a requirement for accurate metrology with the SEM.

Following the publication of this paper, a heightened awareness of the issues associated with SEM metrology prompted significant improvements in the instrumenta-

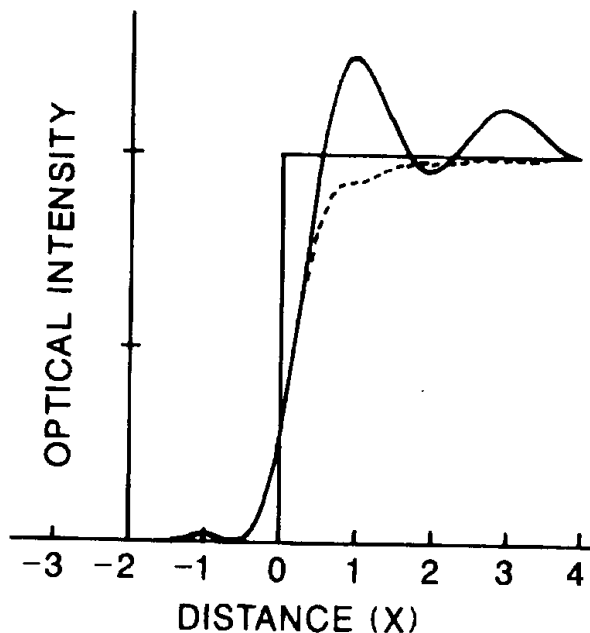

Fig. 1. Comparison of calculated image profiles of the edge of an opaque vertical-wall small-height (e.g., photomask) line. The ordinate is relative transmitted light intensity and the abscissa is the distance from the edge of the line in micrometers. The step-function rise to full transmission shown by the straight lines in the figure represents what one would ideally expect. The bright-field image (solid curve) and the confocal image (dashed curve) show that the edge is not located at the point of 50% of full transmission.

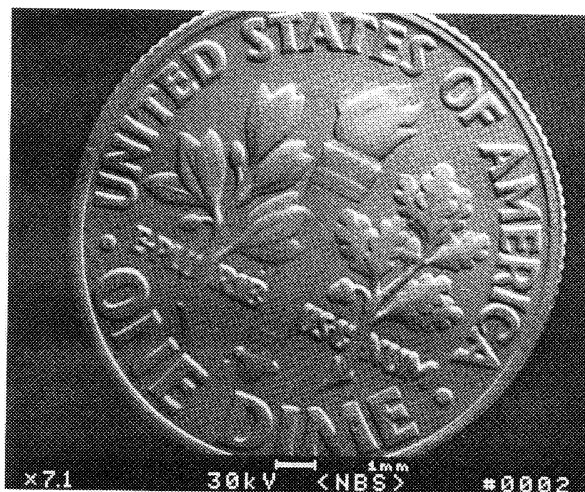

Fig. 2. Scanning electron micrograph of a dime. This image and the discussion in the original paper clearly demonstrated to the reader that one cannot assume that just because the micrograph was taken with an SEM and that the magnification and linescale are displayed that they are accurate. The proper magnification should be 4.6x. This simple demonstration showed that the read-out of the commercial SEM should not necessarily be trusted at face value and thus led many users to scrutinize their SEM measurements more carefully, setting the stage for many new improvements in SEM metrology.

tion as described in later publications [7,10]. Today, fully automated CD-SEM instruments are routinely being utilized in semiconductor production applications throughout the world.

Diana N. Nyyssonen joined NBS as a physicist in 1969 and quickly developed the first photomask linewidth standards. Her work at NBS showed how optical image simulation modeling could be used as a tool for applying optical microscopes in submicrometer metrology and, by so doing, exceed the classical resolution limits of imaging microscopes. She won the Department of Commerce Silver Metal for her work in this area. In 1985, she left NBS to form her own R&D company specializing in optical dimensional metrology. She later joined IBM Corporation and specialized in scanning probe microscopes.

Robert D. Larrabee joined NBS in 1976 as a physicist specializing in the electrical characterization of bulk silicon. In 1985 he became the Group Leader of the Microelectronics Dimensional Metrology Group, replacing Diana Nyyssonen. Under his leadership, the group continued the existing photomask linewidth projects and initiated new SEM metrology programs with Michael Postek and other members of his group [3]. He held the position of Group Leader until his retirement in 1994. In 1999 he participated in the award of the Department of Commerce Bronze metal Team Award for his post-retirement work in developing a new optical overlay metrology tool and a novel standard for use in its alignment.

David C. Joy is currently a Distinguished Scientist, Director of the EM Facility, and Professor at the University of Tennessee. He also holds a joint appointment with Oak Ridge National Laboratory, where he is a member of the Staff in the Materials and Ceramics Division. Since publication of the subject paper, he has contributed to the improvements in SEM and SEM modeling. He has recently published two books, *Monte Carlo Modeling for Microscopy and Microanalysis and Semiconductor Characterization by Scanning Electron Microscopy*. He has contributed to the evolution of the scanning electron microscope as a viable production tool through his research in low accelerating voltage electron microscopy, modeling, electron holography, and nano-tip development.

Michael T. Postek is currently the Leader of the Nano-scale Metrology Group at NIST. Since this paper appeared, he has worked closely with International SEMATECH and its member companies in the development of scanning electron microscopy as a tool for

semiconductor production. He has been awarded a 1998 R&D 100 award for the development of SEM Monitor (a tool used to test the performance level of automated production SEMs) and two Department of Commerce Silver Medals for his work in metrology with the scanning electron microscope. He is currently completing development of an accurate low accelerating voltage SEM magnification standard (SRM 2090), a sharpness standard RM 8091, and a production-critical SEM width standard.

Prepared by Michael T. Postek and Robert D. Larrabee.

Bibliography

- [1] Diana Nyyssonen and Robert D. Larrabee, Submicrometer Linewidth Metrology in the Optical Microscope, *J. Res. Natl. Bur. Stand.* **92**, 187-204 (1987).
- [2] Michael T. Postek and David C. Joy, Submicrometer Microelectronics Dimensional Metrology: Scanning Electron Microscopy, *J. Res. Natl. Bur. Stand.* **92**, 205-228 (1987).
- [3] Robert D. Larrabee and Michael T. Postek, Parameters Characterizing the Measurement of a Critical Dimension, in *Handbook of Critical Dimension Metrology and Process Control*, (SPIE Critical Review, Vol. CR52), Kevin M. Monahan (ed.), SPIE Optical Engineering Press, Bellingham, WA (1994) pp. 2-24.
- [4] Michael T. Postek, Scanning Electron Microscope-based Metrological Electron Microscope System and New Prototype Scanning Electron Microscope Magnification Standard, *Scanning Microsc.* **3**, 1087-1099 (1989).
- [5] R. D. Larrabee, L. Linholm, and M. T. Postek, Microlithography Metrology: Scanning Electron Microscope Metrology, in *Handbook of VLSI Microlithography: Principles, Technology and Applications*, William B. Glendinning and John N. Helbert (eds.), Noyes Publications, Park Ridge, NJ (1991) pp. 148-238.
- [6] Michael T. Postek, Jeremiah R. Lowney, Andras E. Vladar, William J. Keery, Egon Marx, and Robert D. Larrabee, X-ray Lithography Mask Metrology: Use of Transmitted Electrons in an SEM for Linewidth Measurement, *J. Res. Natl. Inst. Stand. Technol.* **98**, 415-445 (1993).
- [7] Michael T. Postek, Critical Issues in Scanning Electron Microscope Metrology, *J. Res. Natl. Inst. Stand. Technol.* **99**, 641-671 (1994).
- [8] Michael T. Postek, Andras E. Vladar, Samuel N. Jones and William J. Keery, Interlaboratory study on the lithographically produced scanning electron microscope magnification standard prototype, *J. Res. Natl. Inst. Stand. Technol.* **98**, 447-467 (1993).
- [9] J. R. Lowney, M. T. Postek, and A. E. Vladar, A Monte Carlo Model for SEM Linewidth Metrology, in *Integrated Circuit Metrology, Inspection, and Process Control VII*, (Proceedings SPIE 2196), SPIE, Bellingham, WA (1994) pp. 85-96.
- [10] M. T. Postek, Scanning Electron Microscope Metrology, in *Handbook of Critical Dimension Metrology and Process Control*, (SPIE Critical Review, Vol. CR52), Kevin M. Monahan (ed.), SPIE Optical Engineering Press, Bellingham, WA (1994) pp. 46-91.

Observation of Atoms Laser-Cooled Below the Doppler Limit

This 1989 paper [1] reported a breakthrough which led to a Nobel Prize for William D. Phillips—the first Nobel to be awarded to a NBS/NIST staff scientist. The experiment described in the paper demonstrated that light from a laser could be used to cool atoms to a much lower temperature than was previously thought possible. The fact that light carries momentum and can exert a force on objects was realized by James Clerk Maxwell in his theory of electromagnetism, developed in the 19th century. At the turn of the century, experiments by Lebedev [2] and Nichols and Hull [3] for the first time measured these forces in the laboratory. This concept of radiation pressure helped explain why comet tails point away from the sun and was important in understanding the stability of certain types of stars, but it had little laboratory relevance until the advent of the laser. In 1975, two groups proposed the counter-intuitive idea that radiation pressure from a laser could be used to *cool* atoms [4,5]. By carefully choosing the frequency of the laser, it appeared possible to cause the atoms to emit light at a slightly higher frequency (energy) than they absorbed, carrying away the thermal energy of the atom. This frequency difference derived from the Doppler shift due to the motion of the atoms. Doppler cooling was first demonstrated [6] with trapped ions in 1978 (at NBS by the Wineland group).

William Phillips joined the Electricity Division at NBS in 1978 to work on the gyromagnetic ratio of the proton and the SI ampere experiments, with the understanding that he could devote some of his time to developing laser cooling ideas for neutral atoms and atomic beams. He was joined in his efforts by a long-term visitor to NBS, Harold Metcalf from the State University of New York at Stony Brook. Several of the key achievements in neutral-atom laser cooling were produced by what would become the Laser Cooling Group. These included the demonstration of efficient ways of decelerating atomic beams with laser light: Zeeman cooling [7], in which the changing Doppler shift of a decelerating atomic beam is compensated by a spatially-varying magnetic field, and “chirped” cooling [8], where the Doppler shift is compensated by a changing laser frequency. These two methods are still the only methods used today to decelerate atomic beams. Another significant accomplishment of the Laser Cooling Group was the first trapping of neutral atoms with magnetic fields [9] in 1985. Magnetic

trapping is now widely used in dozens of experiments studying Bose-Einstein condensation of dilute gases.

By the late 1980s a few groups around the world were investigating the properties of “optical molasses,” the name given to a “sticky” configuration of laser beams that could cool and hold on to atoms for as long as a few seconds. The action of the light upon the atoms created a viscous environment for the atoms, hence the “molasses” appellation. A group at Bell Laboratories, headed by Steven Chu, had measured a temperature of 240 μK [10] for a sample of sodium optical molasses, in accord with the Doppler cooling theory that had been developed a few years earlier. The NBS group had made a number of measurements of the properties of a sodium molasses, such as the lifetime of the atoms in the molasses. Each measurement they made had disturbing discrepancies between the results and the Doppler theory. At the urging of one of the members of the team, Paul Lett, then a recently arrived postdoctoral fellow, they set out to measure the temperature of the atoms. This was something that they had shied away from earlier because its measurement was rather difficult and it had already been done at Bell Labs. They crafted a new, sensitive technique to measure the velocity distribution of the cold atoms, and thus extract the temperature. The time-of-flight technique they developed looked for fluorescence from atoms that traversed a probe laser beam after being released from the molasses. The duration of the pulse of fluorescence would be inversely proportional to the atomic velocity, which would allow the extraction of the temperature. For reasons of convenience, they placed the probe above the molasses (at 240 μK the atoms would have plenty of thermal velocity to overcome gravity to reach the probe). After a number of puzzling days with no signals, they moved the probe *under* the molasses and immediately saw a strong pulse of fluorescence (Fig. 1). To their great surprise, the temperature that they found was 40 μK (the atoms were so cold that gravity turned them around before they could reach the probe placed above the molasses). This result was six times lower than what the theory had predicted was the ultimate limit, the so-called Doppler limit, as well as contradicting the Bell Labs results [11]. To assure that some unknown feature of their new measurement technique was not deceiving them, they measured the temperature with three other methods, all of which were

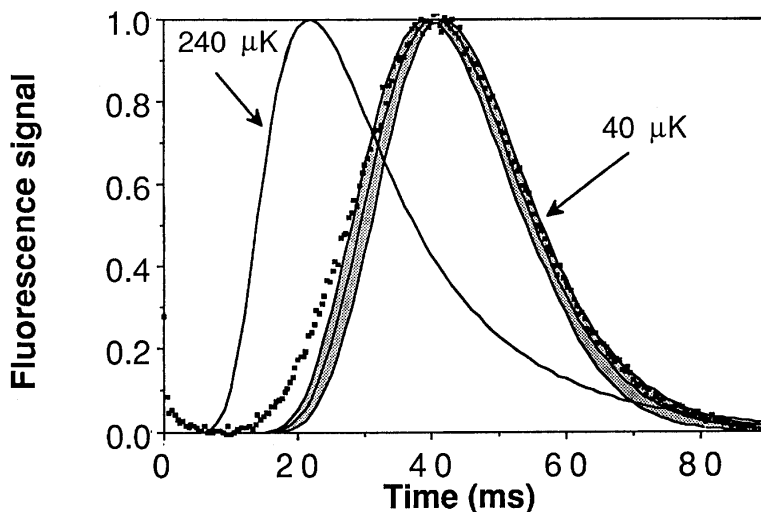

Fig. 1. Time-of-flight measurement of the temperature of optical molasses. The points show the experimental measurements of the time-of-flight distribution of atoms falling from an optical molasses through a probe laser beam situated 12 mm below. The solid lines show the predicted distribution curves for 40 μK and 240 μK (the predicted lower limit of Doppler cooling). The band around the 40 μK curve reflects the uncertainty in the measurement of the geometry of the molasses and probe.

in agreement—the temperature of optical molasses was much lower than anyone had thought possible. This was announced in *Physical Review Letters* and was rapidly confirmed in other laboratories around the world (including that of Chu, who had moved to Stanford). Almost as rapidly, a new theory of laser cooling was developed that explained these results [12]. Not only did it extend the simple theory by taking into account the detailed atomic structure of the atoms, but it also showed that there existed qualitatively different laser-cooling mechanisms that had not been anticipated. (Claude Cohen-Tannoudji shared the 1997 Nobel Prize in Physics with Phillips and Chu, in part for his development of the sub-Doppler laser-cooling theory.)

Spurred in part by the spectacularly low temperatures possible with these new cooling mechanisms, laser-cooling experiments blossomed around the world with more than 100 laboratories involved in such research by the late 1990s. These ultracold temperatures have had an impact in many areas of atomic physics, spawning whole new areas of research, such as ultracold collision physics and optical lattices. They were critical as the first step in the creation of the much sought after Bose-Einstein condensation of an atomic gas, achieved in 1995 at NIST/JILA [13]. The table-top aspect of laser-cooling experiments has spurred their introduction into many undergraduate laboratory courses, providing for many students the first exposure to modern laser technology and atomic physics.

The most significant societal impact of this discovery is in time-keeping, one of the traditional core responsi-

bilities of NBS/NIST. The second is defined with respect to a microwave transition in the cesium atom, which fortuitously is an ideal atom to laser-cool. The sub-Doppler laser-cooling temperature for cesium (1 μK to 2 μK) can be *100 times* lower than the Doppler limit. Because such cold atoms move so slowly, they can be observed for a much longer time than was previously possible, dramatically increasing the precision and accuracy of a cesium frequency standard. Using an idea from 1954, well ahead of its time but now made possible with sub-Doppler laser cooling, the cesium atoms form an atomic fountain, undergoing a one meter high parabolic trajectory in the earth's gravitational field with a resulting hundred-fold increase in the observation time. This has led to an immediate improvement of the performance of frequency standards and, as of this writing, the definition of the second is in large part determined by laser-cooled cesium atomic clocks, including NIST's F-1 fountain standard which came on line in December 1999.

William Phillips joined the Electricity Division at NBS in 1978, and began his research in laser cooling soon thereafter, while continuing involvement in the Ampere experiment. Paul Lett, Richard Watts, Christoph Westbrook, and Phillip Gould were all post-doctoral fellows in the group in 1988 at the time of the publication of the sub-Doppler cooling paper. Lett has remained at NIST as a staff physicist in the Laser Cooling and Trapping Group; Watts was a staff physicist in the Photon Physics Group at NIST, but died in 1996; Westbrook left NIST in 1993 to become a staff physicist



Fig. 2. Current permanent staff members of the NIST Laser Cooling and Trapping Group, as photographed in Stockholm for the awarding of the 1997 Nobel Prize in Physics. From the left: Paul Lett, Steven Rolston (joined NBS in 1988), William Phillips, and Kristian Helmerson (joined NIST in 1991).

at l' Institut d'Optique, Orsay, France; Gould left NBS in 1988 to become a professor of Physics at the University of Connecticut. Harold Metcalf was a visiting scientist at NBS/NIST and is a professor of physics at the State University of New York at Stony Brook. The Laser Cooling and Trapping Group moved to the Atomic Physics Division in the Physics Laboratory at NIST in 1991. The group has continued to be an active, prolific group, with over 25 publications in premier journals such as *Physical Review Letters*, *Nature*, and *Science*. They are recognized world leaders in the areas of laser cooling, ultracold collision physics, optical lattices, and Bose-Einstein condensation. Phillips was recognized as a co-recipient of the 1997 Nobel Prize in Physics "for development of methods to cool and trap atoms with laser light" [14].

Prepared by Steven Rolston.

Bibliography

- [1] P. D. Lett, R. N. Watts, C. I. Westbrook, W. D. Phillips, P. L. Gould and H. J. Metcalf, Observation of atoms laser cooled below the Doppler limit, *Phys. Rev. Lett.* **61**, 169-172 (1988).
- [2] P. Lebedev, Untersuchungen über die Druckkräfte des Lichtes, *Ann. Phys.* **6**, 433 (1901).
- [3] E. F. Nichols and G. F. Hull, A Preliminary communication on the pressure of heat and light radiation, *Phys. Rev.* **13**, 307-320 (1901).
- [4] D. Wineland and H. Dehmelt, Proposed $10^{14} \Delta\nu < \nu$ laser fluorescence spectroscopy on Tl^+ mono-ion oscillator III, *Bull. Am. Phys. Soc., Ser. II*, **20**, 637 (1975).
- [5] T. W. Hänsch and A. L. Schawlow, Cooling of gases by laser radiation, *Opt. Commun.* **13**, 68-69 (1975).
- [6] D. J. Wineland, R. E. Drullinger and F. L. Walls, Radiation-pressure cooling of bound resonant absorbers, *Phys. Rev. Lett.* **40**, 1639-1642 (1978).
- [7] W. D. Phillips and H. Metcalf, Laser deceleration of an atomic beam, *Phys. Rev. Lett.* **48**, 596-599 (1982).
- [8] J. V. Prodan and W. D. Phillips, Chirping the Light—Fantastic? Recent NBS Atom Cooling Experiments, in *Laser-cooled and Trapped Atoms*, W. D. Phillips (ed.), NBS Special Publication 653, National Bureau of Standards, Washington, DC (1983) pp. 137-141.
- [9] A. L. Migdall, J. V. Prodan, W. D. Phillips, T. H. Bergeman, and H. J. Metcalf, First observation of magnetically trapped neutral atoms, *Phys. Rev. Lett.* **54**, 2596-2599 (1985).
- [10] S. Chu, L. Hollberg, J. E. Bjorkholm, A. Cable and A. Ashkin, Three-dimensional viscous confinement and cooling of atoms by resonance radiation pressure, *Phys. Rev. Lett.* **55**, 48-51 (1985).
- [11] The high temperatures measured at Bell Labs have been attributed to the stray magnetic fields from an ion pump.
- [12] J. Dalibard and C. Cohen-Tannoudji, Laser cooling below the Doppler limit by polarization gradients: simple theoretical models, *J. Opt. Soc. Am. B* **6**, 2023-2045 (1989).
- [13] M. H. Anderson, J. R. Ensher, M. R. Matthews, C. E. Wieman, and E. A. Cornell, Observation of Bose-Einstein Condensation in a Dilute Atomic Vapor, *Science* **269**, 198-201 (1995).
- [14] Steven Chu, The manipulation of neutral particles, *Rev. Mod. Phys.* **70**, 685-741 (1998); Claude N. Cohen-Tannoudji, Manipulating atoms with photons, *ibid.*, pp. 707-719; William D. Phillips, Laser cooling and trapping of neutral atoms, *ibid.*, pp. 721-741. These papers are the Nobel lectures in physics, 1997.

Laser-Excited Hot-Electron Induced Desorption

The quest for femtochemistry provided a guiding motivation for many researchers [1,2] far in advance of the award of the 1999 Nobel Prize in Chemistry to Ahmed Zewail “for his pioneering investigation of fundamental chemical reactions, using ultra short laser flashes, on the time scale on which the reactions actually occur” [3]. The rich array of possibilities that femtochemistry potentially offered within the domain of surface-science-related phenomena was the driving force for a very significant research effort, starting in the mid 1980s, involving core members of the Surface Dynamical Processes Group within the Surface Science Division (SSD). This group was first part of the Center for Chemical Physics, then the Center for Atomic, Molecular, and Optical Physics, and most recently the Chemical Science and Technology Laboratory. The initial desorption results with pulsed laser-induced surface processing reported in 1988 [4] strongly suggested that an entirely new physical mechanism, different from that operating in gas phase femtochemistry, was required to account for the laser-induced molecular processes on solid surfaces. Stimulated by this discovery, a transient quantum wave packet model was conceived, developed, and first reported in the 1990 paper *Laser-excited hot-electron induced desorption: a theoretical model applied to NO/Pt(111)* [1]. In this model, laser-excited hot electrons produced within the solid are inelastically scattered from the surface chemical system via resonance formation of a temporary negative ion. This picture has become a standard paradigm for modeling, and hence understanding, almost all hot-electron-induced molecular processes at surfaces involving not only laser excitation, but also STM (Scanning Tunneling Microscope)-, tunnel junction-, and electrochemically-produced hot electrons. For this reason among others, the consequences of this coupled theoretical and experimental research are expected to have an active and lasting impact on our understanding and control of many of the most important electron-induced surface processes of chemical significance [5].

The decade of the 1970s was filled with the excitement accompanying the initial development, utilization, and theoretical interpretation of surface-sensitive spectroscopic probes which enabled a quantum mechanical description of clean and composite surfaces. Our ability to determine not only the electronic state of the surface

[6], but also the properties characterizing the quantized nuclear motion of the bound constituent atoms, as revealed in vibrational spectroscopies [7], were opening up entirely new vistas in conceptualizing and understanding surface properties and processes. Once the machinery for static surface characterization was in place, it was natural to address next the intellectual and technical challenges presented in surface dynamics. This was understood to mean the observation and control of time-dependent fundamental processes that are the atomic-level (both spatial and temporal) building blocks determining the rates for excitation, decay, growth, aging, chemical reactions, catalysis, etc. Bond-selective nonequilibrium placement of energy within a molecular system, subsequent energy flow and redistribution, intentional use of the out-of-equilibrium state, and production of far-from-statistical product distributions and branching ratios became the new goals.

In the late 1970s, Rich Cavanagh came to NBS as an NRC Postdoctoral Fellow working with John Yates, initially on infrared and neutron surface vibrational spectroscopy and thermal desorption. About the same time, David King joined the laser chemistry group headed by John Stephenson to study time-dependent, laser-assisted molecular processes in the gas phase. A propitious collaboration was initiated between Cavanagh and King which produced the first-ever quantum-state-specific (translational, vibrational, and rotational) energy distribution measurements of molecules thermally desorbed from metal surfaces (NO/Ru(001)) in which laser excited fluorescence (LEF) techniques were used to deduce the internal state population distributions [8]. In early 1988, new NRC Postdoctoral Fellows Steve Buntin and Lee Richter joined Cavanagh and King to study “fast” pulsed laser-induced desorption, again using LEF to interrogate the desorbed molecules. This combination of laser applications, both as an active participant in the process under study (desorption) and also as a diagnostic tool (energy distributions), was crucial in the development of femtosecond surface chemistry [9,10]. In their “paradigm-establishing” 1988 note in *Physical Review Letters* [4], convincing evidence was presented which suggested that, contrary to expectations, desorption was caused not by local laser heating of either the substrate lattice or by the direct pumping of the adsorbate-surface bond, but instead by some as yet unknown mechanism involving electrons

that were “super-heated” far in excess of the surface temperature. As more fully understood later, the degree of excess electron heating is very dependent on the temporal width of the incident laser pulse; tens of femtosecond pulses produce much hotter electrons (but for a shorter length of time!) and, as a result, cause different surface reactions than do pico-to-nanosecond pulses with equal energy content [9,11]. This distinction has turned out to be very important in the pursuit of surface femtochemistry [9,10]

From the theoretical point of view, Bill Gadzuk had for a long time been keenly interested in the electronic properties of adsorbed systems [6]. By the 1980s, his considerations had also shifted towards problems in surface dynamics, particularly ones involving atomic motion triggered by electron charge transfer [12] and resonance scattering [13] involving atoms on surfaces. At the time of the first laser desorption experiments, he was working with John Yates (formerly from the SSD, then and now at the University of Pittsburgh [14]) on what appeared to be resonant electron stimulated desorption [15]. Together with Charles Clark, he developed a model that explained observations from Yates’ group showing a highly sensitive dependence of the desorption yield of NO/Pd(111) on the energy of the incident exciting electron beam, exactly in the fashion of a hot-electron resonant desorption process [16]. Since

the model did not care how the energetic or hot electrons got “hot,” it was as applicable to the laser-induced hot-electron desorption phenomena under study experimentally by Buntin et. al [4] as to the external electron-beam experiments of Yates’ group [15]. With this realization, it was relatively easy to work the ESD theory [15,16] into a theory for laser desorption, an exercise which produced the 1990 paper [1] and later refinements [2].

The proposed optically driven non-thermal desorption version of the general hot-electron model unfolds in the following way. The incident photon pulse excites a non-equilibrium continuous distribution of hot electrons with energies in the range $\epsilon_{\text{Fermi}} < \epsilon_{\text{in}} < \epsilon_{\text{Fermi}} + h\nu$ where ϵ_{Fermi} is the Fermi level of the substrate and $h\nu$ the photon energy, as illustrated in Fig.1. This results in a transient flux of hot electrons incident upon the surface from within. For those photoexcited electrons resonant with the lowest unoccupied “level” of the adsorbate (labeled as the $2\pi^*$ orbital for NO/Pt), the incident electron with energy ϵ_{in} may hop onto the adsorbed NO, reside in this resonance for a time τ_{R} , and then scatter back into an unoccupied conduction band state with energy $\epsilon_{\text{fin}} \leq \epsilon_{\text{in}}$, leaving behind some part of the adsorption system excited with energy $\epsilon = \epsilon_{\text{in}} - \epsilon_{\text{fin}}$. With regards to the NO-surface interaction, labeled $V_{\text{a}}(z)$ in Fig.2, when the incident electron becomes trapped in

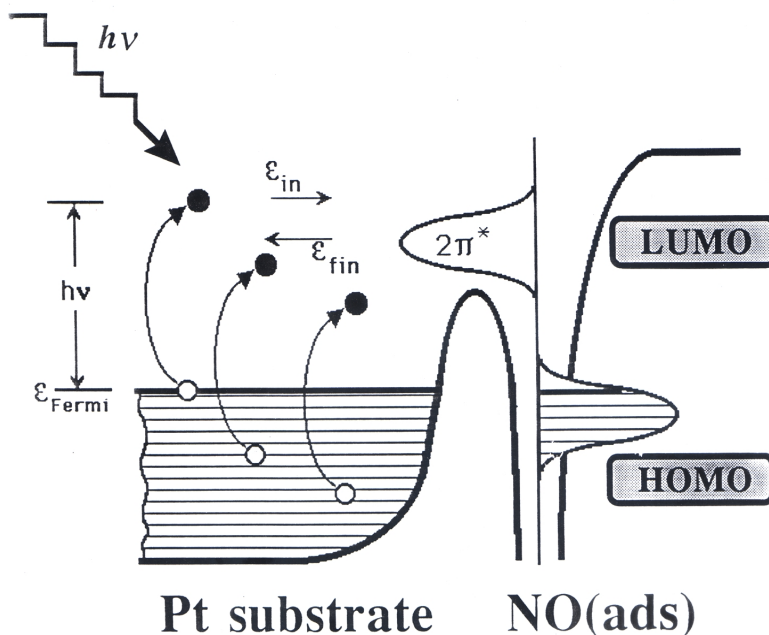

Fig. 1. Energy level diagram for inelastic hot electron scattering through the lowest unoccupied molecular orbital (LUMO) resonance associated with the adsorbed molecule, also showing the highest occupied molecular orbital (HOMO) resonance level.

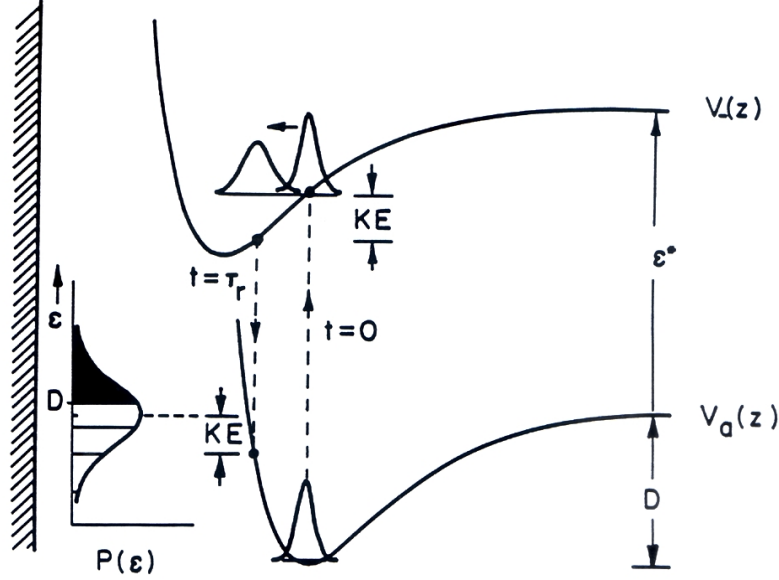

Fig. 2. Schematic potential energy curves for center of mass translational motion of adsorbed neutral and negative ion species with respect to the surface, showing wavepacket propagation throughout the time sequence involving the negative ion resonance. The distribution of final adsorbate states between vibrationally excited bound and desorptive continuum states is shown as $P(\epsilon)$ versus ϵ .

the $2\pi^*$ resonance, an additional ionic attraction is turned on, resulting in an augmented negative ion/surface potential labeled $V_-(z)$. The desired attribute is that the intermediate state is one in which attractive forces are applied to the NO^- , thus requiring different equilibrium geometries for the two charge states.

With these thoughts in mind, it was hypothesized that the actual resonance desorption event occurs in the following way. Upon capture of the incident electron in the $2\pi^*$ orbital, ϕ_0 , the ground state wavepacket characterizing the nuclear motion of the adsorbed NO, suddenly finds itself as $\phi(t)$, a time-evolving non-stationary state on $V_-(z)$, as in a Franck-Condon transition, and thus accelerates inwards towards the surface. After a time interval τ_R = the negative ion resonance lifetime, the trapped electron on NO^- departs, and the moving displaced and distorted wavepacket is returned to $V_a(z)$, possibly on the steeply repulsive inner wall, again as a Franck-Condon transition, but this time involving the projection of a moving initial state wavepacket on both the discrete bound and continuum desorptive states of $V_a(z)$. The theory established that the translational energy distribution of excited states resulting from this sequence of electronic transitions is given by:

$$P(\epsilon; \tau_R) = \frac{1}{2\pi} \int_{-\infty}^{\infty} dt' e^{i\epsilon t'} \langle \phi(t'=0; \tau_R) | \phi(t'; \tau_R) \rangle$$

which is the Fourier transform of the time-dependent overlap of $|\phi(t'=0; \tau_R)\rangle$, the state initially prepared on V_a at $t = \tau_R$ after experiencing the forces on the negative

ion, with $|\phi(t'; \tau_R)\rangle$ the subsequent neutral state which time evolves on V_a . Theoretical methods for evaluating such expressions using intuitively straightforward semiclassical Gaussian wavepacket dynamics were available at that time and were incorporated into the theory [13]. The desorption or bond-breaking probability per resonance event $\equiv P_D(\tau_R)$ is given by the integral over those states with energy greater than D , the desorption energy as represented by the area under the filled-in region of the final state distribution labeled $P(\epsilon)$ in Fig. 2. As is apparent, the dynamics on $V_-(z)$, the intermediate state potential energy curve, can easily lead to a substantial electron-assisted desorption probability.

The desorption rate, which is in principle a measurable quantity of importance, is proportional to the product of $P_D(\tau_R)$ multiplied by the rate of electron capture into the resonance which, by microscopic reversibility equals $1/\tau_R$, the decay rate or inverse resonance lifetime. The theory provided relationships between the independent parameters defining the desorption system, namely: the time scale for atomic or wave packet motion on the potential curves in Fig. 2 and τ_R , the resonance lifetime, both given in terms of ω_0 , the oscillator frequency of the well; D , the desorption energy; and Δz , the displacement of the minimum of V_- with respect to V_a which is a measure of the force on the adsorbate when it is a temporary negative ion. An example of the theoretical results [2] are shown as dN_{des}/dt vs. $\omega_0\tau_R$ plots in Fig. 3 for a range of Δz , with $D \approx 1$ eV (as for NO/Pt). An initial increase in desorp-

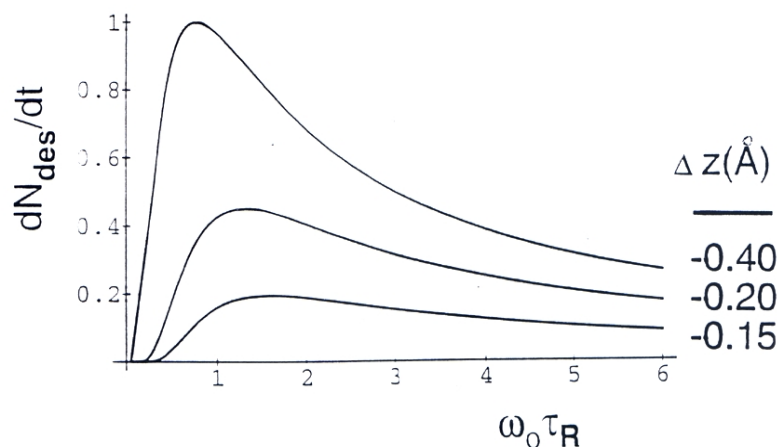

Fig. 3. Desorption rate versus resonance lifetime (in units of $\omega_0 = 2\pi/T$ where T , the vibrational period associated with the adsorption potential well, ≈ 70 fs for NO/Pt) with selected values of displacement for V_- , the negative ion potential, with respect to V_a , as labeled. While the absolute scale of the dN_{des}/dt axis is arbitrary, the curves are properly scaled with respect to each other.

tion rate is experienced as τ_R increases from zero due to the increasing displaced nuclear dynamics. Larger Δz , hence larger forces, results in larger desorption rates. Ultimately the diminishing electron capture rate implied by longer τ_R wins out, the desorption rate achieves a maximum and then decreases with further increases in τ_R . Emphasis has been placed on the crucial role of τ_R because it is also the time interval between switching on and off the intermediate state potential. Human control of this attribute allows for the selective control of reaction outcomes [17], the hallmark of femtochemistry [2]. The unification of system characteristics of this sort has provided an intuitively clear picture of resonant hot electron induced bond excitation processes that has subsequently been used as the basic model in many new and developing areas of molecular processing in surface science, surface femtochemistry, current-driven STM atom transfer, manipulation, and fabrication, and in novel meso-scopic and nanotechnology applications.

Throughout the decade since this work was carried out, all five participants have remained active in various roles at NIST. The experimentalists continued their forefront studies in controlled, time-resolved molecular processes at surfaces, particularly those involving time-delay, pump-probe techniques to observe time-resolved phenomena at the femtosecond level. Some of this work has been summarized in a Feature Article in the *Journal of Physical Chemistry* [9]. The authors have presented numerous invited talks at international scientific meetings, workshops, and Gordon Conferences, introducing the surface science, chemical physics, and chemical

technology worlds to the allures and potentialities of surface femtochemistry. Lee Richter is currently developing new chemically sensitive probes for biologically interesting surfaces and interfacial systems based on near field scanning optical microscopy and on sum-frequency generation [18]. Steve Buntin is engaged in the study of radical reactions with well characterized surfaces that are of industrial relevance [19].

It appears that doing laser-excited surface experiments is good training for management careers at NIST. Over the intervening years, Rich Cavanagh has risen to become Chief of the Surface and Microanalysis Science Division. Buntin has succeeded him as leader of the Surface Dynamical Processes Group. Dave King spent five years as a program manager in the Advanced Technology Program and now serves as Science Advisor to the Undersecretary of Commerce for Technology. Bill Gadzuk has remained engaged in theoretical studies involving hot electrons, femtochemistry, tunneling phenomena [6], and related topics. In a recent commissioned Topical Review that appeared in the *Journal of Physics B* [20], he emphasized the intellectual stimulation provided by numerous NIST colleagues from other organizational units. As in many other NBS/NIST achievements, these cross-disciplinary interactions have played a key role in the success of his research. In at least one vision of an ideal world, this is how things should work!

Prepared by J. W. Gadzuk.

Bibliography

- [1] J. W. Gadzuk, L. J. Richter, S. A. Buntin, D. S. King, and R. R. Cavanagh, Laser-excited hot-electron induced desorption: a theoretical model applied to NO/Pt(111), *Surf. Sci.* **235**, 317-333 (1990).
- [2] J. W. Gadzuk, Resonance-assisted, hot-electron-induced desorption, *Surf. Sci.* **342**, 345-358 (1995).
- [3] Ahmed H. Zewail, Femtochemistry: Atomic-Scale Dynamics of the Chemical Bond, *J. Phys. Chem. A* **104**, 5660-5694 (2000).
- [4] Steven A. Buntin, Lee J. Richter, Richard R. Cavanagh, and David S. King, Optically Driven Surface Reactions: Evidence for the Role of Hot Electrons, *Phys. Rev. Lett.* **61**, 1321-1324 (1988).
- [5] W. Ho, Reactions at Metal Surfaces Induced by Femtosecond Lasers, Tunneling Electrons, and Heating, *J. Phys. Chem.* **100**, 13050-13060 (1996).
- [6] E. W. Plummer, J. W. Gadzuk, and R. D. Young, Resonance Tunneling of Field Emitted Electrons Through Adsorbates on Metal Surfaces, *Solid State Commun.* **7**, 487-491 (1969).
- [7] John T. Yates, Jr. and Theodore E. Madey (eds.), *Vibrational Spectroscopy of Molecules on Surfaces*, Plenum Press, New York (1987).
- [8] Richard R. Cavanagh and David S. King, Rotational- and Spin-state Distributions: NO Thermally Desorbed from Ru(001), *Phys. Rev. Lett.* **47**, 1829-1832 (1981).
- [9] R. R. Cavanagh, D. S. King, J. C. Stephenson, and T. F. Heinz, Dynamics of Nonthermal Reactions: Femtosecond Surface Chemistry, *J. Phys. Chem.* **97**, 786-798 (1993).
- [10] J. W. Gadzuk, Hot-Electron Femtochemistry at Surfaces, in *Femtosecond Chemistry, Vol. 2*, J. Manz and L. Wöste (eds.), VCH Verlagsgesellschaft, Weinheim (1995) pp. 603-624.
- [11] Hua Guo, Peter Saalfrank, and Tamar Seideman, Theory of photoinduced surface reactions of ad molecules, *Prog. Surf. Sci.* **62**, 239-303 (1999).
- [12] J. W. Gadzuk, Surface Harpooning, *Comments At. Mol. Phys.* **16**, 219-240 (1985).
- [13] J. W. Gadzuk, The Semiclassical Way to Molecular Dynamics at Surfaces, *Annu. Rev. Phys. Chem.* **39**, 395-424 (1988).
- [14] Ted Madey and John Yates, Electron-Simulated Desorption, in *A Century of Excellence in Measurements, Standards, and Technology: A Chronicle of Selected NBS/NIST Publications, 1901-2000*, David R. Lide (ed.), NIST Special Publication 958, U.S. Government Printing Office, Washington, DC (2001) pp. 219-223.
- [15] Alon Hoffman, Xingcai Guo, John T. Yates, Jr., J. W. Gadzuk, and C. W. Clark, Electron-stimulated desorption and surface species conversion: The observation of a desorption resonance for atomic oxygen on the Pd(111) surface, *J. Chem. Phys.* **90**, 5793-5800 (1989).
- [16] J. W. Gadzuk and C. W. Clark, Resonance enhanced electron stimulated desorption, *J. Chem. Phys.* **91**, 3174-3181 (1989).
- [17] Stuart A. Rice and Meishan Zhao, *Optical Control of Molecular Dynamics*, John Wiley, New York (2000).
- [18] Lee J. Richter, Teresa P. Petralli-Mallow, and John C. Stephenson, Vibrationally resolved sum-frequency generation with broad-bandwidth infrared pulses, *Opt. Lett.* **23**, 1594-1596 (1998).
- [19] Steven A. Buntin, Dynamics of the H atom abstraction of D adsorbed on Si(100), *J. Chem. Phys.* **108**, 1601-1609 (1998).
- [20] J. W. Gadzuk, Breathing mode excitation in near-harmonic systems: resonant mass capture, desorption and atoms in optical lattices, *J. Phys. B: At. Mol. Opt. Phys.* **31**, 4061-4084 (1998).

Measurement of the Universal Gas Constant Using an Acoustic Resonator

Competition is a great motivator. The 1988 measurement of the universal gas constant R at NIST [1] was stimulated by an error made at a rival national metrology institute, Great Britain's National Physical Laboratory (NPL). In 1976, a group at NPL reported a "new" value for the universal gas constant R that had a standard uncertainty of 8.4 ppm (1 ppm = 1 part in 10^6). The "new" value was 159 ppm larger than the "older" 1972 value of R that had an uncertainty of 31 ppm (See Fig. 1.).

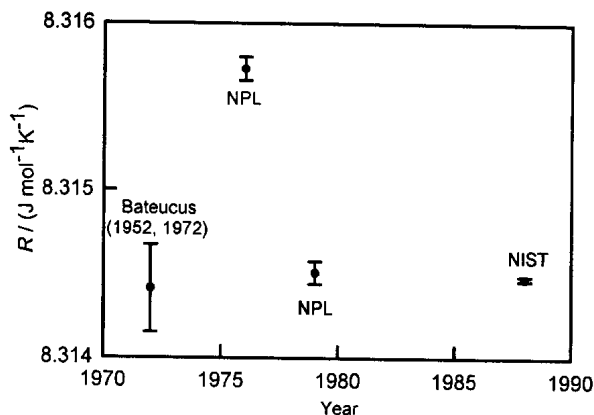

Fig. 1. History of measurements of R . The standard uncertainty of NIST's 1988 measurement is $14 \mu\text{J mol}^{-1} \text{K}^{-1}$, a value that is approximately the size of the plotted symbol.

The mutually inconsistent "old" and "new" values of R troubled many scientists, including Ralph Hudson, Chief of the Heat Division of NBS. Ralph solicited proposals to redetermine R in novel ways. In response, Mike Moldover proposed to determine R by measuring the speed of sound in argon using a spherical acoustic resonator [2]. This proposal was never formally funded; it was never a milestone in a performance plan. However, Moldover was encouraged to proceed on a part-time basis. Soon, Jim Mehl at the University of Delaware became a collaborator. Guest scientists Martin Trusler and Terry Edwards joined in the mid 80s, followed by Rich Davis, NBS' expert in mass metrology.

Twelve years after research began, the measurements were successfully completed. As shown in Fig. 1, NIST's 1988 value of R (and NPL's corrected 1978

value) are consistent with the "old" value of R albeit with the much smaller standard uncertainty of 1.7 ppm. The NIST result $R = 8.314\,472(15) \text{ J mol}^{-1} \text{ K}^{-1}$ was recommended by CODATA in 1999, and the research effort was honored with NIST's Stratton Award.

After completing the measurement of R in 1988, Moldover and his collaborators [3] used the same acoustic resonator in the temperature range 217 K to 303 K to measure the thermodynamic inconsistency of the ITS-90, the International Temperature Scale of 1990. (The ITS-90 is a set of carefully crafted recipes for accurately determining the temperature from procedures such as measuring the resistance of very pure platinum wire.)

In characteristic NBS/NIST fashion, the insights gained from measuring R and studying the ITS-90 are being applied to industrial problems. NIST's Fluid Science Group uses acoustic resonators to measure the thermodynamic and transport properties of gases, including environmentally acceptable refrigerants and semiconductor process gases. In 1997, the spherical resonator was given to NIST's Temperature Group where Dean Ripple and his collaborators rebuilt it to study the ITS-90 up 800 K.

In order to place the 1988 measurement of R in context, we shall describe the role that R plays in temperature metrology, the connection between R and the speed of sound, and the remarkable symmetry that made the accurate acoustic measurement of R possible. Then, to convey the flavor of the metrology, we describe the measurement of the resonator's volume. We conclude with a few remarks concerning acoustic thermometry.

With commercially available thermostats, platinum resistance thermometers, and triple point cells, it is much easier to reproduce any particular temperature than it is to measure any of the fundamental statistical mechanical quantities that characterize that temperature (e.g., the average kinetic energy E in a mechanical degree of freedom). Simply put, it is much easier to measure a " T " than E . This very practical consideration led the designers of the International System of Units (SI) to define temperature as an independent physical quantity. The definition specifies that the kelvin (K) is the unit of the temperature and that the temperature of the triple point of water T_w is exactly 273.16 K. In this context, the Boltzmann constant is $k_B = 2E/T_w$ and the

universal gas constant is $R = N_A k_B = 2EN_A/T_w$, where N_A is the well-known Avogadro constant, which relates the atomic mass unit to the kilogram. Thus, the 1988 measurement of R was equivalent to measuring E at the temperature T_w .

The 1988 measurement of R immediately led to a 5-fold reduction in the uncertainty of both the Boltzmann constant k_B and the Stefan-Boltzmann constant σ . [$\sigma \equiv 2\pi^5 k_B^4 / (15h^3 c^2)$ is used in radiation measurements. Here, h is Planck's constant and c is the speed of light.] The more accurate values of R , k_B , and σ will be used by national metrology institutes for calibrating a few vital primary thermometers that have designs that do not permit their use at T_w . (Primary thermometers, such as gas, noise, acoustic, and radiation thermometers measure E or its equivalent, and are used to calibrate other thermometers, such as platinum resistors.)

The most common use of R is in calculating gas densities ρ from the virial equation of state:

$$pV = \rho RT[1 + b(T)\rho + \dots]$$

Today, the uncertainty of R is much smaller than the uncertainties of the other quantities in this equation.

The 1988 measurement of R was based on measuring the speed of sound in argon. The speed of sound u was deduced from the resonance frequencies f_n of radially symmetric acoustic oscillations of argon enclosed by a thick spherical shell that had a carefully measured internal volume ($V \approx 3$ L. See Fig. 2.) An exactly known eigenvalue z_n connects these quantities through $u = V^{1/3} f_n / z_n$. A detailed theory correcting this equation had to be derived and tested by rigorous measurements [4].

In a dilute gas, the speed of sound u is connected to E by kinetic theory and hydrodynamics:

$$E = \frac{1}{2} m v_{\text{rms}}^2 = \frac{3}{2} k_B T, \quad u^2 = \gamma v_{\text{rms}}^2$$

(Here, v_{rms} is the root mean square speed of a gas molecule, m is the mass of one molecule, and γ is the heat capacity ratio that has the zero-pressure limit 5/3 for the monatomic gases.) These equations can be rewritten in terms of the molar quantities $M = N_A m$ and $R = N_A k_B$ to get a simple equation for R :

$$R = \frac{M}{T} \lim_{p \rightarrow 0} \frac{u^2}{\gamma} = \frac{M}{273.16 \text{ K}} \frac{3}{5} \lim_{p \rightarrow 0} \left(\frac{V^{1/3} f_n}{z_n} \right)^2$$

Thus, to measure R one must measure M , V , and f_n , all at T_w , and extrapolate to the limit of low pressure.

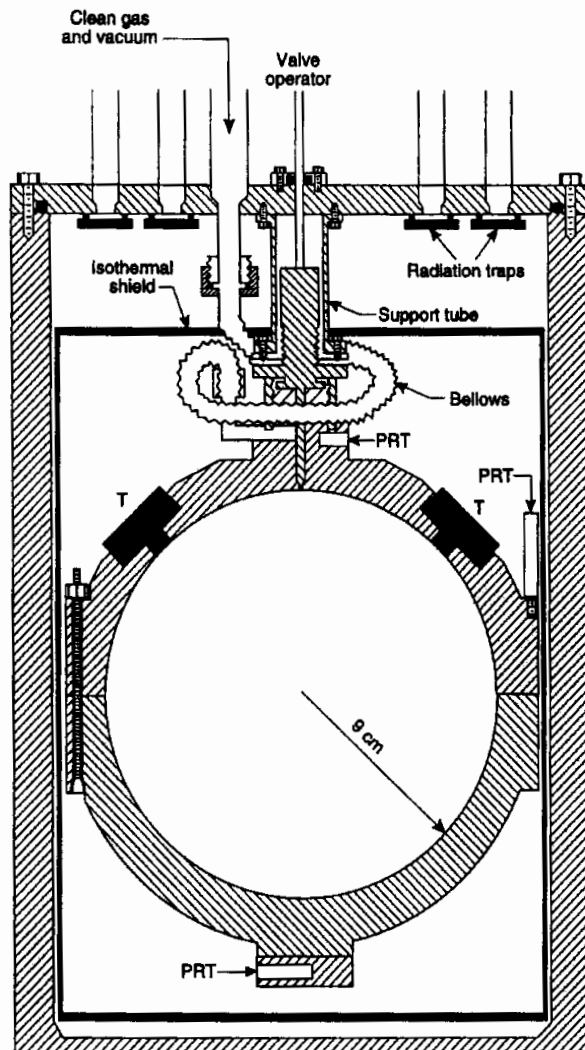

Fig. 2. Cross-section of the resonator and pressure vessel. “T” indicates the acoustic transducers; “PRT” indicates the platinum resistance thermometers. The pressure vessel was immersed in a thermostatted bath (not shown). The isothermal shield was installed after the measurement of R to reduce the temperature gradients when the resonator was used for thermometry at temperatures down to 217 K.

The thermodynamic temperature of a dilute, monatomic gas can be deduced from the ratio of two speed of sound measurements, one at T and a second at T_w :

$$T = 273.16 \text{ K} \times [u(T)/u(T_w)]^2$$

In some respects, primary acoustic thermometry is easier than measuring R . Neither V nor M must be measured accurately. For thermometry, the thermal expansion of V must be measured accurately, and this is done using microwave resonances.

The frequencies f_n are sensitive to small, smooth departures from perfect spherical geometry *in the second order*, provided that the volume is unchanged. Thus, a spherical shell built to machine-shop tolerances, e.g., one part per thousand, could be used to measure R with an uncertainty on the order of the square of (one part per thousand) = 1 ppm. In fact finer tolerances were achieved in this work. This was confirmed by the 0.34 ppm internal consistency of the speed-of-sound results obtained using five different radially symmetric acoustic modes spanning the frequency range 2.5 kHz to 9.5 kHz.

The weak dependence of the frequencies on shape imperfections appears in S. A. Moszkowski's 1955 calculation of energy levels in deformed nuclei. In the course of the gas constant work, Mehl and Moldover generalized this symmetry to vector (electromagnetic) fields confined by a conducting sphere [5]. Their generalization made it practical to determine the thermal expansion of spherical shells from the resonance frequencies of a few, selected microwave modes within the shell.

The 1988 paper concerning R took a year to write and filled 60 pages of the *Journal of Research of the NBS* [1]. It took 43 pages to describe the experimental procedures and the analysis of the data. Instead of summarizing this exhaustive work, we shall convey its flavor by outlining only the measurement of the resonator's volume V .

The principle of the volume measurement was simple. The mercury required to fill the resonator was weighed and the known density of mercury was used to convert the weight to a volume. To implement this principle with the required accuracy, the resonator was reconfigured to resemble a dilatometer. The valve in the top of the resonator was replaced with a glass capillary tube and the acoustic transducers were replaced with carefully designed plugs. The reconfigured resonator was immersed in a bath thermostatted at T_w .

For the weighings, the mercury was held in an especially designed weighing vessel. For each volume determination, the vessel was weighed when it was full of mercury and again after the mercury required to fill the resonator had been pumped out of it. As a check, the vessel was weighed again after the mercury was returned to it.

If a bubble were in the mercury inside the resonator, the weighings would have underestimated the volume of the resonator. Concern about this led to a delicate test for bubbles. After the mercury was pumped into the resonator, it overflowed, partially filling the glass capillary tube atop the resonator. A measured overpressure of argon was applied to the mercury meniscus in

the glass capillary causing the meniscus to move downward. The change of the meniscus' height was compared with that expected from the known compressibility of mercury and the calculated compliance of the 19 mm-thick, stainless steel shell. Because bubbles are much more compliant than mercury and steel, this test would have detected a bubble with a volume of 3×10^{-7} V.

The calculation of the shell's compliance used its dimensions, the tabulated properties of stainless steel, and a simple model. However, this calculation is not completely trustworthy because the shell was a complex, assembled object. Thus, the calculation was checked by a measurement. This was done while gas was sealed within the shell. The pressure outside the shell was reduced, causing the shell to expand slightly and the acoustic resonance frequencies to decrease by $(-12.8 \pm 0.4) \times 10^{-6}$ MPa $^{-1}$. The compliance determined in this way was 6 % larger than the calculated compliance; however, this difference was within the combined uncertainties.

The effect of the mercury's pressure on the volume and the sagging of the resonator when it was filled with 40 kg of mercury were taken into account.

When the acoustic transducers were replaced with mercury-compatible plugs for the weighings, the volume of the resonator changed. This volume change was measured in an auxiliary experiment where the plugs and transducers were interchanged in a small acoustic coupler. These coupler experiments also accounted for the effective volume that resulted from the transducers' compliance.

Because mercury is a mixture of isotopes, the density of mercury varies slightly, depending on its source and how it is handled (e.g., purified by multiple distillation). The mercury used in the volume determination was taken from a vault at NBS where it had been stored since A. H. Cook had standardized it in 1961. Thus, its density near 20 °C was well known 24 years before it was used. A sample of this mercury was compared to a sample from a similar stock maintained at the Australian national metrology laboratory, CSIRO. Within the uncertainty of the comparison, any changes that might have occurred during 24 years of storage were identical at NBS and CSIRO.

Cook's recommended data for the thermal expansion of mercury between T_w and 20 °C was used; however, the uncertainty of the thermal expansion data was the largest contributor to the uncertainty of the volume. (See Table 1.) Several years later, Moldover and several colleagues showed that the thermal expansion of the spherical cavity, as deduced from microwave resonances within it, was consistent with that deduced from mercury dilatometry.

Two complete volume determinations were made in September 1985 and a third was made in April 1986. The standard deviation of their mean was 0.29 ppm. The weighings were extraordinarily reproducible.

The measurements of the temperature T , molar mass M , and the resonance frequencies f_n , received as much attention as the measurement of the resonator's volume V . Thus, it was not an accident that the uncertainties of T , M , f_n , and V were approximately equal (0.8 ppm; see Table 1.).

Table 1. Relative standard uncertainties in parts per million from various sources in the redetermination of R

(Volume) ^{2/3}	
Density of mercury at 20 °C	0.28
Storage and handling of mercury	0.20
Thermal expansion of mercury (0 °C to 20 °C)	0.67
Random error of volume determination from weighings	0.20
Temperature	
Random error of calibrations	0.8
Temperature gradient	0.4
Molar Mass	
⁴⁰ Ar standard	0.7
Comparison of commercial argon to ⁴⁰ Ar	0.26
Zero-pressure limit of $(f_n/z_n)^2$	
Standard deviation of u_0^2 from 70 observations (at 14 pressures)	0.68
Thermal boundary-layer correction	0.30
Possible error in positions of transducers	0.55
Square root of the sum of the squares	1.7

After the 1988 measurement of R was completed, Moldover and his collaborators used the resonator to measure $(T - T_{90})$, the difference between the thermodynamic temperature and ITS-90. In Fig. 3, their results in the range 217 K to 303 K are highlighted by a solid curve and are labeled “NIST Acoustic (1999).”

The “NIST Acoustic (1999)” data had a standard uncertainty of 0.6 mK, which is approximately 2 ppm of T . This uncertainty is much smaller than that of any other method of measuring $(T - T_{90})$. In Fig. 2, the “UCL Acoustic (1994)” results were obtained by Ewing and Trusler using a smaller, less elaborately characterized, spherical acoustic resonator. It is very reassuring that the NIST and UCL results agree, within combined uncertainties.

Fig. 3 implies that ITS-90 can be improved with the help of primary acoustic thermometry. It is possible that

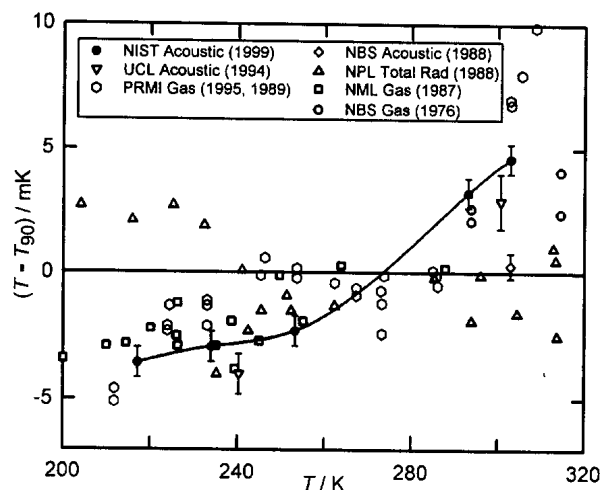

Fig. 3. Comparison of the Kelvin thermodynamic temperature T and the International Temperature Scale of 1990 T_{90} . The “NIST Acoustic (1999)” data were obtained using the gas-constant resonator.

this will be done after primary acoustic thermometry is extended to 800 K, perhaps in the next few years.

Mike Moldover joined the Heat Division at NBS in 1972 and began working with acoustic resonators in the late 1970s. He has made accurate measurements of many thermophysical properties, including density, heat capacity, viscosity, dielectric constant, speed of sound, surface tension, and refractive index. Many of these measurements were made very near liquid-vapor critical points. Moldover is now developing an atomic standard of pressure that will require measurements of the dielectric constant of helium with part per billion uncertainties. He is a NIST Fellow and Leader of the Fluid Science Group of the Process Measurements Division.

Martin Trusler and Terry Edwards were postdoctoral guest researchers at NIST during the redetermination of R . Trusler is now on the Chemical Engineering Faculty of Imperial College in London and Edwards is now on the Faculty of the Centre for Oil and Gas Engineering of the University of Western Australia. Jim Mehl has maintained a strong collaboration with NBS/NIST since 1979. During this interval he has been a Professor of Physics, Department Chair, and Associate Dean at the University of Delaware. Now retired from Delaware, Jim continues to collaborate with the NIST group. Rich Davis was a physicist in the Length and Mass Division of NIST. He is now Head of the Mass Section at the BIPM in Sevres, France.

Prepared by Michael R. Moldover.

Bibliography

- [1] M. R. Moldover, J. P. M. Trusler, T. J. Edwards, J. B. Mehl, and R. S. Davis, Measurement of the universal gas constant R using a spherical acoustic resonator, *J. Res. Natl. Bur. Stand.* **93**, 85-144 (1988).
- [2] Michael R. Moldover, Meyer Waxman, and Martin Greenspan, Spherical acoustic resonators for temperature and thermophysical property measurements, *High Temp. High Pressures* **11**, 75-86 (1979).
- [3] M. R. Moldover, S. J. Boyes, C. W. Meyer, and A. R. H. Goodwin, Thermodynamic temperatures of the triple points of mercury and gallium and in the interval 217 K to 303 K, *J. Res. Natl. Inst. Stand. Technol.* **104**, 11-46 (1999).
- [4] Michael R. Moldover, James B. Mehl, and Martin Greenspan, Gas-filled spherical resonators: Theory and experiment, *J. Acoust. Soc. Am.* **79**, 253-272 (1986).
- [5] James B. Mehl and Michael R. Moldover, Measurement of the ratio of the speed of sound to the speed of light, *Phys. Rev. A* **34**, 3341-3344 (1986).

Thermal and Oxidative Degradation of Polymers

In recent decades synthetic polymeric materials, because of their unique physical properties, have rapidly replaced more traditional materials such as steel and nonferrous metals, as well as natural polymeric materials such as wood, cotton, and natural rubber. However, one weak aspect of synthetic polymeric materials compared with steel and other metals is that these materials are combustible under certain conditions. Thus the majority of polymer-containing end products (for example, cables, TV sets, electric appliances, carpets, furniture) must pass some type of regulatory test to help ensure public safety from fire. However, traditional pass/fail tests have not provided any information regarding the relationship between flammability properties and the physical and chemical characteristics of polymeric materials. Such information is needed to develop more fire-safe materials, a need that has accelerated because of European environmental concerns about the use of halogenated flame retardants (because of potential formation of dioxins in the incineration of spent end products). The paper *Effects of Weak Linkages on the Thermal and Oxidative Degradation of Poly(methyl methacrylate)* [1] is one of a series published on this topic by the members of the Materials Fire Research Group at NBS/NIST from 1985 to 1994 [2-11]. These

papers report a new approach that studies the effects of molecular-level structure of polymers on their thermal stability and flammability properties instead of a traditional global thermal-balance approach. This series of studies is built upon the pioneering work on thermal degradation of polymers conducted at NBS from the late 1940s to early 1970s [12].

Providing the technical basis for industrial clients to design less flammable materials requires unfolding the structural features that determine thermal stability. This paper [1] reports a study of the thermal and oxidative degradation mechanisms of an acrylic polymer in atmospheres of nitrogen and air by measuring the change in the sample mass while various specially polymerized samples were heated from 80 °C to 480 °C. Thermal degradation of the acrylic polymer, polymerized using a free-radical method, proceeds in three steps of mass loss: the first and easiest (scheme 1 in Fig. 1) is initiated by scissions of head-to-head linkages at about 160 °C (representing one type of defect at the polymer backbone); the second (scheme 2) by scissions at the chain-end initiation from vinylidene ends at around 270 °C; and the last (scheme 3) by random scission within the polymer chain (at the weakest bonds).

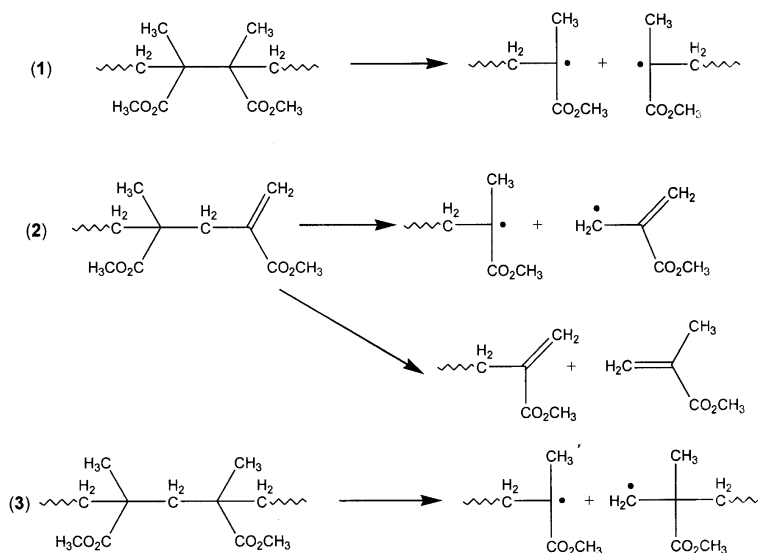

Fig. 1. Three chain scission steps leading to thermal degradation in acrylic polymers.

The first two mass loss steps were not observed with ionically polymerized samples, which indicates that the first two steps are caused by the defects in the polymer. Although the existence of head-to-head linkages could not be demonstrated, the vinylidene ends in the polymer were detected by the ^1H NMR spectrum. No significant differences were seen in the thermal or oxidative degradation of the acrylic polymer when it was polymerized with the free-radical method using two common initiators. It was found that gas-phase oxygen traps polymer radicals resulting from chain scissions at head-to-head linkages, and no mass loss was observed from this step in air. Similarly, oxygen traps radicals generated by end initiation, but mass loss is only delayed to slightly higher temperatures, presumably because of a slight gain in the thermal stability of the oxygen-trapped polymers compared with end initiation.

This series of studies involved not only experimental observations, but also theoretical calculations in which kinetics equations were solved for each polymer chain. Detailed thermal degradation models were developed based on random initiation, depropagation of free radicals, and termination of free radicals; calculations were made with the assumption of steady-state free radical concentration [4], and without that assumption [5]. The kinetic rate constants for each reaction were derived by comparing experimentally measured molecular weights of polymer samples collected at various temperatures and exposure times with the theoretically calculated results [6]. The final paper of the series on thermal degradation investigated the behavior of primary radicals generated from random scissions by measuring evolved degradation products with a mass spectrometer [9].

The influence on thermal stability by the above-discussed defects in the polymer have been studied and published [7,8,10]. The results show that a higher thermal stability increases piloted-ignition delay time and gasification rate of the polymer, but initial molecular weight does not affect ignition delay time. On the other hand, initial molecular weight of the polymer has significant effect on flame spread rate because low molecular weight materials will flow more readily when heated. The physical and chemical roles of the condensed phase in the burning process of polymeric materials were published as a summary of this series of studies [11].

The molecular-level study of the thermal degradation and flammability properties of polymers described above was pursued further by Marc Nyden and coworkers at NIST. They used molecular dynamic simulations of thermal degradation of polyethylene to identify factors that might be effective in reducing polymer flammability by promoting the formation of residual

char [13]. The results predicted that the formation of cross-linking, for example by exposure of polyethylene to ionizing radiation, enhanced further cross-linking when the polymer is burned. An increase in ignition delay time was observed for irradiated polyethylene samples compared to unexposed samples. A similar approach has been pursued by Charles Wilkie at Marquette University, Richard Lyon at the FAA Technical Center, and James McGrath at Virginia Polytechnic Institute and State University.

Because of the increasing demand for non-halogenated flame retardant additives for polymeric end products, this molecular-level study has been extended to include flame retardant mechanisms of polymers containing small quantities of inorganic flame retardant additives. As a result of advances in nanoscale science and technology, molecular-level studies of the effects of trace additives in clay-polymer nano-composites are demonstrating enhanced physical properties with simultaneous improvements in the flammability properties of polymers. This contrasts with the traditional approach, which improves the flammability but often degrades mechanical properties.

The study described in this paper involved the synthesis of specific polymers, analytical characterization of the synthesized polymers, and careful thermogravimetric analysis. Two different groups, the Materials Fire Research Group at NIST and Department of Chemistry at Osaka University, contributed their own expertise to this highly collaborative undertaking. The group at Osaka University synthesized and characterized all polymer samples used in the study, while the group at NIST performed the thermogravimetric analyses.

Takashi Kashiwagi joined NBS in 1971 after he received his Ph.D. from Princeton University. He was a group leader from 1988 to 1998 in the Fire Science Division. He is currently a materials research engineer working on improved fire-safe materials, as well as studying ignition and flame spread in a microgravity environment. He was a principal investigator of the ignition and flame spread experiment conducted on Space Shuttle flight STS-75.

Atsushi Inaba received his Ph.D. in chemical engineering from Tokyo University in 1981 and was a guest scientist at NBS from May 1984 to March 1986. He is currently Director of the Research Planning Office of the National Institute for Resources and Environment in Japan.

James E. Brown joined the Polymer Division of NBS in 1956 as a research chemist, moved to the Fire Science Division in 1975, and retired in 1996. Koichi Hatada, a professor in the Department of Chemistry at Osaka University, was known internationally for his work on

stereoregular and living polymerization and copolymerization. He retired from Osaka University in 1998 after serving as vice president of the University. Tatsuki Kitayama is a professor in the Chemistry Department of Osaka University. Eiji Masuda was a student under Prof. Hatada and is currently a senior research scientist at Polyplastics Co. in Japan.

Prepared by Takashi Kashiwagi.

Bibliography

- [1] Takashi Kashiwagi, Atsushi Inaba, James E. Brown, Koichi Hatada, Tatsuki Kitayama, and Eiji Masuda, Effects of Weak Linkages on the Thermal and Oxidative Degradation of Poly(methyl methacrylates), *Macromolecules* **19**, 2160-2168 (1986).
- [2] Takashi Kashiwagi, T. Hirata, and J. E. Brown, Thermal and Oxidative Degradation of Poly(methyl methacrylate): Molecular Weight, *Macromolecules* **18**, 131-138 (1985).
- [3] Toshimi Hirata, Takashi Kashiwagi, and James E. Brown, Thermal and Oxidative Degradation of Poly(methyl methacrylate): Weight Loss, *Macromolecules* **18**, 1410-1418 (1985).
- [4] Atsushi Inaba and Takashi Kashiwagi, A Calculation of Thermal Degradation Initiated by Random Scission. 1. Steady-State Radical Concentration, *Macromolecules* **19**, 2412-2419 (1986).
- [5] Atsushi Inaba and Takashi Kashiwagi, A Calculation of Thermal Degradation Initiated by Random Scission, Unsteady Radical Concentration, *Eur. Polym. J.* **23**, 871-881 (1987).
- [6] Atsushi Inaba, Takashi Kashiwagi, and James E. Brown, Effects of Initial Molecular Weight on Thermal Degradation of Poly(methyl methacrylate): Part 1—Model 1, *Polym. Degrad. Stab.* **21**, 1-20 (1988).
- [7] T. Kashiwagi and A. Omori, Effects of Thermal Stability and Melt Viscosity of Thermoplastics on Piloted Ignition, in *Twenty-Second Symposium (International) on Combustion: At the University of Washington, Seattle, Washington, August 14-19, 1988*, The Combustion Institute, Pittsburgh, PA (1988) pp. 1329-1338.
- [8] T. Kashiwagi, A. Omori, and J. E. Brown, Effects of Material Characteristics on Flame Spreading, in *Fire Safety Science—Proceedings of the Second International Symposium*, Hemisphere Publishing Corp., New York (1989) pp. 107-117.
- [9] Takashi Kashiwagi, Atsushi Inaba, and Anthony Hamins, Behavior of Primary Radicals during Thermal Degradation of Poly(Methyl Methacrylate), *Polym. Degrad. Stab.* **26**, 161-184 (1989).
- [10] Takashi Kashiwagi, Atsushi Omori, and Hidesaburo Nanbu, Effects of Melt Viscosity and Thermal Stability on Polymer Gasification, *Combust. Flame* **81**, 188-201 (1990).
- [11] T. Kashiwagi, Polymer Combustion and Flammability—Role of the Condensed Phase, in *Twenty-Fifth Symposium (International) on Combustion: At the University of California, Irvine, California, July 31-August 5, 1994*, The Combustion Institute, Pittsburgh, PA (1994) pp. 1423-1437.
- [12] S. L. Madorsky, *Thermal Degradation of Organic Polymers*, Interscience Publishers, New York (1964).
- [13] Marc R. Nyden, Glenn P. Forney, and James E. Brown, Molecular Modeling of Polymer Flammability: Application to the Design of Flame-Resistant Polyethylene, *Macromolecules* **25**, 1658-1666 (1992).

HAZARD I: *Software for Fire Hazard Assessment*

NIST Handbook 146, *HAZARD I—Fire Hazard Assessment Method* [1], represents the culmination of a long-term program aimed at placing the prediction of fire outcomes on an objective and scientific basis. In the 1970s, NIST supported Harvard University to develop numerical models that could predict the temperature in a room containing a fire. These early models were difficult to use and interpret; required large, mainframe computers that were available only in academic institutions; and were plagued with long execution times, often interrupted by software crashes. Major pieces of fire physics and most fire chemistry were not well enough understood to be included in the models, so that predictive accuracy was disappointing. As a result, these early models were little more than academic playthings which were seldom put to practical use.

In 1983, NIST's fire program established a goal to develop a tool that could evaluate the role of the fire performance of an individual material or product in the outcome of a specific fire in a specific compartment or group of compartments. The first year of the project was devoted to determining the capabilities needed to accomplish this, and the effort was somewhat daunting. Not only would it be necessary to predict the fire environment in the space resulting from the material or product burning, but it would also require understanding the movement and behavior of occupants and the physiological and psychological effects of exposure to this fire.

Since the project started before the personal computer revolution, the initial plan was to develop the software to run on NIST's mainframe and to equip a "fire simulation laboratory" at NIST with terminals and graphics equipment so that scientists and engineers could learn how to use the software to address practical problems. Once the usefulness of these models were appreciated, the larger engineering firms were expected to invest in the hardware needed to exploit the technology. It was expected that these firms would have the computers to run the software in their own offices by the end of the century.

By 1986 the NIST multi-compartment model, FAST (Fire and Smoke Transport) [2] had been enhanced so that its predictions were credible when applied within specific bounds. NIST's pioneering development of oxygen consumption calorimetry provided a means to measure the rate at which mass and energy were released from a burning item. By expressing a material's

fire performance in terms of conserved quantities, it was possible to describe burning behavior for a predictive model. A NIST psychologist was developing a unique evacuation model with embedded behavioral rules derived from interviews with fire victims. Finally, the NIST combustion toxicology program was producing data that showed toxicological effects were primarily from a small number of toxic species.

Also at this time, the personal computer revolution was well underway. It became clear that a computer on every desktop would soon be a reality, so the NIST software was now targeted at that group of users. Efforts were expended on an improved user interface that would both simplify data entry at the front end and provide graphical output support to make the results more understandable and useful at the back end.

The first version of the *HAZARD I* software and documentation [1] was released in 1989. The software was clearly focused on material and product manufacturers as a tool to assess the fire hazards of their products and a means to justify higher costs associated with better performing products. However, the manufacturers were underwhelmed because the methods required skill to apply and were unproven.

Several factors soon began to change perceptions of the potential of *HAZARD I*. There was political pressure to regulate combustion toxicity, with one state actually promulgating a regulation. NIST produced a fire hazard analysis that showed burning rate was much more important as an indicator of fire hazard than toxicity. In addition, a well respected fire protection engineer became interested in learning these new techniques and successfully applied *HAZARD I* to absolve clients of liability in civil litigation involving a fire. This led to additional uses in both civil and criminal litigation and represented the first significant application of modern fire models.

The publication of NIST Handbook 146 was a watershed for NIST in several ways. While NIST had developed and distributed other software products (such as DATAPLOT, a scientific graphing package), *HAZARD I* was an engineering analysis tool that could be used to make (literally) life and death decisions. It contained a broad range of engineering and scientific methodology that needed to be appropriately documented. Documentation consisted of a Technical Reference Guide which underpins the equations and assumptions and explains how they are coded, a set of worked examples, and a

Users' Guide to the software. The product was packaged as a commercial product with printed binders for the manuals, shrink wrapped disks with the software and installation program, and even a printed function key template. This Handbook received special scrutiny on technical, policy, and legal fronts and was the model for most NIST software to follow.

The *HAZARD I* product was distributed under a formal agreement with the National Fire Protection Association (NFPA), a not-for-profit standards organization. They offered for purchase an initial package, upgrades when issued by NIST, and discounts for their members. Over a decade they sold several thousand copies.

One interesting aspect of this development relates to the exclusion of government-developed software from copyright. Since the software is in the public domain, users are legally unencumbered by the cautions in the documentation. A solution was found by including a users' registration card to be signed, dated, and returned in order to qualify for technical support. The signature on the card was below a statement that the signer read and agreed to the limitations in the documentation—thus creating a contractual agreement. Later, a Government Accounting Office study of the copyright policy that applies to government software cited two specific examples of critical government software that should have copyright protection—Grateful Med from the National Library of Medicine and *HAZARD I*. Several

legislative proposals on this issue were considered, but never adopted.

By 1990, successes in litigation led the fire protection engineering community to begin to use *HAZARD I* in building design. While building codes prescribed the minimum required fire safety features of buildings, they also contained a provision recognizing alternative approaches that can be shown to provide equivalent protection. Demonstrating this equivalence to regulatory authorities was always the difficult part. Now *HAZARD I* could be used to show equivalence in safety to occupants rather than having to prove that an alternative approach performed the same function.

The acceptance of *HAZARD I* in demonstrating code equivalence led to a global revolution in building codes. It became possible for codes to specify only the desired outcomes in terms of life safety and property protection and to allow any solutions that provided that level of performance. Such performance-based codes had long been discussed, but were impractical until means were available to measure fire safety performance quantitatively. The U.S. building regulatory community began work on a performance code in 1996 that is expected to be published in 2000. As similar codes are developed and adopted in other countries, they are eliminating non-tariff barriers to trade that result from unique test-methods that are being replaced by nearly uniform performance objectives. *HAZARD I* and its components are

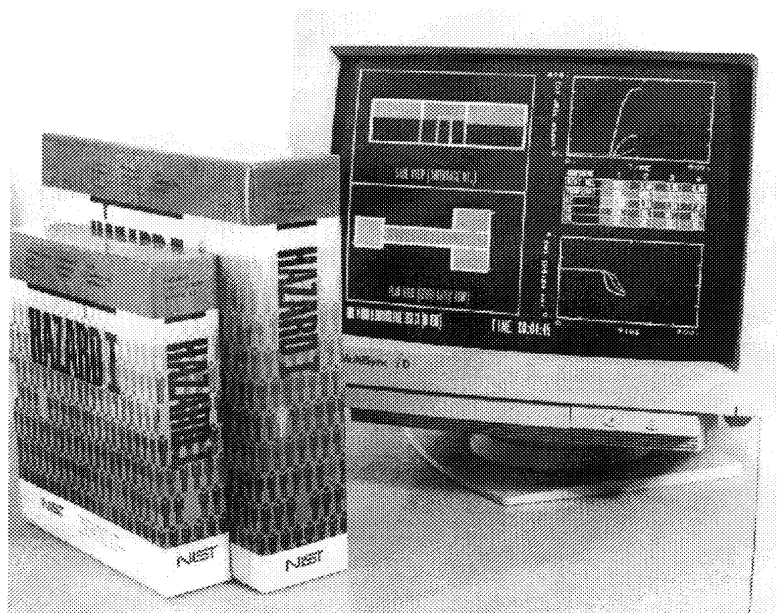

Fig. 1. The *HAZARD I* software and documentation package.

specifically cited in most of these codes and supporting guidelines documents as an acceptable means of demonstrating compliance with the codes.

HAZARD I included several technological advances that were crucial to its acceptance in practice. First, the fire model, FAST, was more robust and easier to use because of a significant investment in the user interface software. There were embedded databases of material properties, and additional references to data were cited. One of the criteria used by the development team was to require as inputs only data that are available and to cite sources for everything. Many other models of the time used engineering estimates that required coefficients to be entered by the user based solely on judgment rather than properties for which measurement methods and handbook values existed.

The equation solver used was carefully selected to work efficiently and seldom failed to converge. The software could be run interactively (with real-time graphics) for exploratory purposes or in batch mode to generate case files or for sensitivity analysis in engineering applications.

The FAST model predictions were compared to a range of full-scale experimental data and these comparisons were published to form a body of verification literature. Further, a suite of test cases stressed the model in different ways to see if it would fail. This test suite was run each time the model was modified. Computer Aided Software Engineering (CASE) tools were used to document changes to the model and to allow changes to be reversed if necessary. Each revision of the software was backward compatible so that users would not have to work excessively to re-run older cases, and the effect of changes was documented. Each of these aspects followed good (commercial) software development practice.

The EXITT (for Exit Time) [3] evacuation model differed from most of its contemporaries in the inclusion of a behavioral module. Other evacuation models of the day had everyone making the correct decisions and, while some allowed for user-selected decision delays, people marched quickly toward the exits. In *HAZARD I*, people investigated the fire until seeing smoke or flame, assisted other family members, or even (children) hid or waited for instructions from an adult. The result was an amazingly realistic sequence of actions and an evacua-

tion process that convinced users and authorities of its applicability.

The toxicology module TENAB (for Tenability) [1] was, and still is, the only attempt to model physiological effects of the inhalation of a mixture of toxic gases. Based on correlations to data from animal exposures, but with an implementation that mimics important physiological interactions, the model produced results that aligned well with actual fire experience. In one case, *HAZARD I* successfully predicted the development of the fire, including a prediction of which occupants successfully escaped and which died, including the location of the bodies and the autopsy results on each. This particular case involved NIST using *HAZARD I* to support a Justice Department attorney to defend the federal government in a wrongful death suit from a fire on a military base. The final analysis indicated no fault by the government, and the day following the deposition of the NIST staff, the plaintiff's counsel offered to settle this \$26.5 million suit for \$180 thousand.

NIST's pioneering work to develop engineering tools to predict fire performance in buildings, and especially the *HAZARD I* methodology, represented the enabling technology for the move to performance-based building and fire codes which are being adopted globally. The methods and models included in *HAZARD I* are routinely cited in these performance-based codes and in their associated codes of practice, worldwide. These performance methods are reducing the costs of fire safety and are eliminating non-tariff barriers to trade for U.S. companies.

Prepared by Richard Bukowski.

Bibliography

- [1] Richard W. Bukowski, Richard D. Peacock, Walter W. Jones, and C. Lynn Forney, *HAZARD I—Fire Hazard Assessment Method*, NIST Handbook 146, National Institute of Standards and Technology, Gaithersburg, MD (1989).
- [2] Walter W. Jones, *A Model for the Transport of Fire, Smoke, and Toxic Gases (FAST)*, NBS Internal Report 84-2934, National Bureau of Standards, Gaithersburg, MD (1984).
- [3] Bernard M. Levin, *EXITT—A Simulation Model of Occupant Decisions and Actions in Residential Fires: Users Guide and Program Description*, NBS Internal Report 87-3591, National Bureau of Standards, Gaithersburg, MD (1987).

Analysis of the Catastrophic Rupture of a Pressure Vessel

On July 23, 1984, an explosion followed by a fire occurred at a petroleum refinery in Chicago, killing 17 people and causing extensive property damage [1]. NBS was requested by the Occupational Safety and Health Administration (OSHA) to conduct an investigation into the failure of the pressure vessel that eyewitnesses identified as the initial source of the explosion and fire. This vessel was an amine absorber tower used to strip hydrogen sulfide from a process stream of propane and butane. The vessel was 18.8 m tall, 2.6 m in diameter, and constructed from 25 mm thick plates of type ASTM A516 Grade 70 steel.

The investigation was complicated by the damage caused by the explosion and fire. The explosive force had been sufficient to propel the upper 14 m of the vessel a distance of 1 km from its original location, while the base remained at the center of the subsequent fire.

Sections of the vessel were shipped to NBS in August 1985, where a multi-disciplinary team sought the cause of the failure. The team was led by Harry McHenry, who was the Deputy Chief of the Fracture and Deformation Division and a leading expert in fracture mechanics. The study eventually involved 23 staff members from three different Divisions from both the Boulder and Gaithersburg laboratories of NBS.

The investigation that followed was a diagnostic masterpiece pursued with textbook elegance and deliberation. After documenting the history of the vessel prior to its rupture, testing of the vessel segments began with nondestructive evaluation techniques. Magnetic particle inspection was applied to reveal hundreds of cracks confined mainly to the inner surfaces along the welds between Courses 1 and 2 of the vessel and between Courses 2 and 3. Ultrasonic measurements subsequently detected clear indications of delamination damage confined to Course 1. However, thickness measurements, made with a micrometer, showed that Courses 1 and 2 had wall thicknesses well within the prevailing allowances for pressure vessels.

More aggressive measurements were then undertaken to examine the mechanical and chemical characteristics of the initial and replacement components. Test after test showed that all initial and replacement components satisfied the industry standard specifications. The cause of failure did not become clear until metallography results were combined with stress corrosion

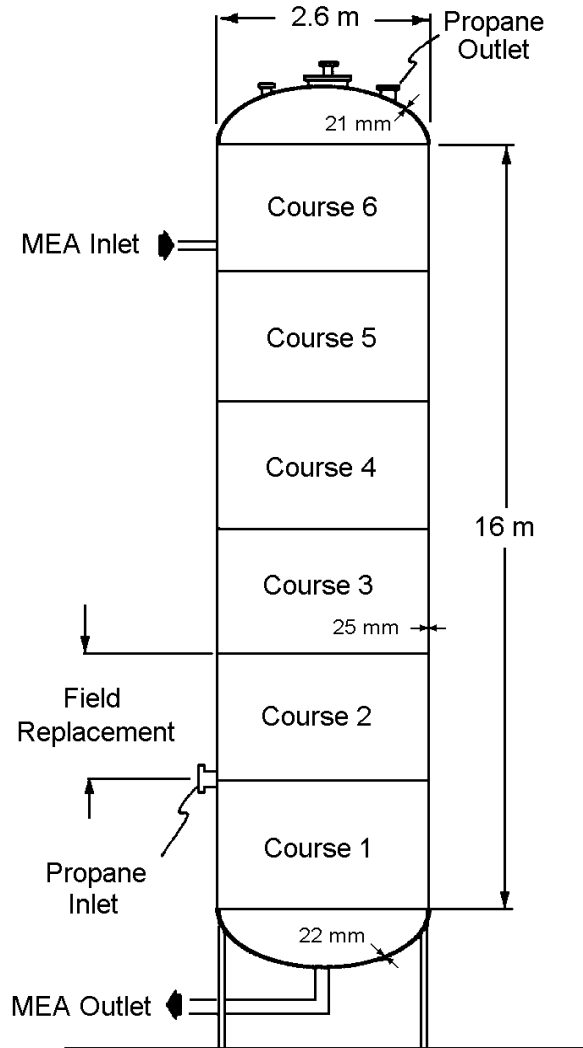

Fig. 1. Schematic of the original pressure vessel consisting of a series of sections know as Courses.

cracking and hydrogen embrittlement tests, followed by a fracture mechanics analysis. It appeared that a pre-existing crack had extended through more than 90 % of the wall thickness and was about 800 mm in length. Further, it was determined that hydrogen embrittlement had reduced the fracture resistance of the steel by more than half. After approximately 6 months of investigation, the findings were published as NBSIR 86-3049 [1].

The vessel had been put into service in 1970 and had undergone several repairs and modifications before the July 1984 incident. The failure investigation determined that the vessel fractured along a path that was weakened by extensive cracking adjacent to a repair weld joining a replacement section to the original vessel. These pre-existing cracks initiated in areas of hard microstructure known to be susceptible to hydrogen stress cracking. This hard microstructure formed during the repair welding of the replacement section. The cracks grew

through the vessel wall as a result of hydrogen pressure cracking. When the depth of the largest of these pre-existing cracks exceeded 90 % to 95 % of the wall thickness, the remaining thin ligament of steel in the cracked section ruptured and leakage occurred. This crack triggered a complete fracture of the vessel circumference at the operating stress level of only 35 MPa (roughly 10 % of the rated strength of the steel) because the toughness of the vessel steel had been reduced by hydrogen embrittlement.

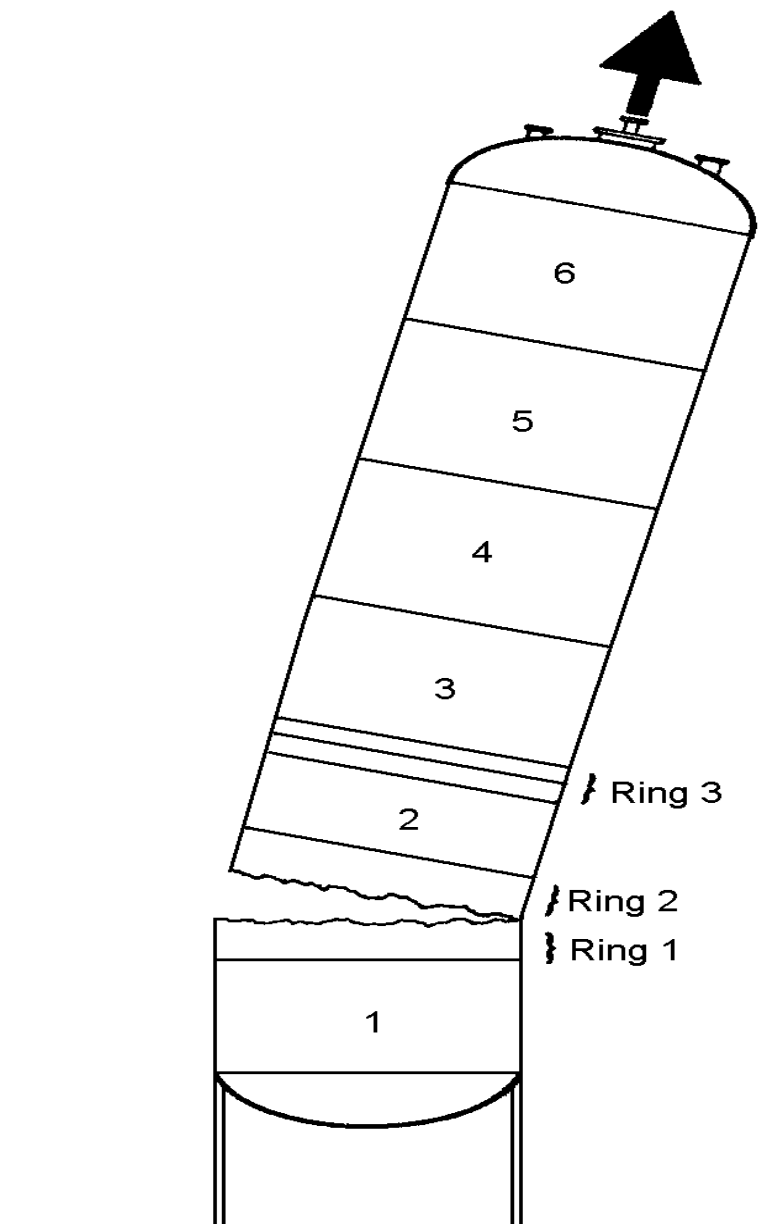

Fig. 2. The pressure vessel ruptured adjacent to the repair weld joining Courses 1 and 2.

The NBS publication pointed out previously unrecognized interactions between pressure vessel steel, the thermal cycles that occur during repair welds, and hydrogen-containing environments. Rapid dissemination of this information was important because many other vessels in the petrochemical and chemical processing industries might have had histories with a similar combination of these factors, and so might also be at risk of a similar catastrophic failure. In late 1986, the findings of the report were summarized in articles published in *Corrosion Science* [2] and *Materials Performance* [3], journals which were widely read by industrial process engineers and safety officials in these industries.

OSHA recognized the technical complexities involved in assessing the mechanical integrity of the various items of equipment used in process industries such as petroleum refineries and petrochemical manufacturing. To provide the OSHA inspectors and regulators with necessary technical information regarding the design and construction and related factors affecting the integrity of process equipment, OSHA engaged NIST to perform two additional tasks:

- (1) Prepare an information document titled: "Guidelines for Pressure Vessel Safety Assessment" for distribution within OSHA, and
- (2) Organize and conduct a training course (Course 340, Hazard Analysis in the Chemical Processing Industries) for OSHA inspectors, with informative lectures concerning pressurized equipment. The first course was taught at NBS (Boulder) in 1988.

The publication of the findings in *Corrosion Science* [2] and *Materials Performance* [3] allowed industrial process engineers and inspection personnel to update the inspection plans for plants under their control. Now that they were aware of the conditions found in this study, the inspection personnel could search for similar problems (such as hydrogen blisters and cracks) during the next annual or biennial shutdowns of processing plants under their control, and inspection intervals could be adjusted accordingly.

Several years following the failure incident and the NBS/NIST report, OSHA issued a final rule titled "Process Safety Management of Highly Hazardous Chemicals, Explosives and Blasting Agents." This rule was published as 29CFR Part 1910 in the Federal

Register on February 24, 1991, and became effective on May 26, 1992. The rules have had a major impact on the process industry, particularly those parts that indicated, for example, that inspection and testing procedures to assess the mechanical integrity of process equipment shall follow recognized and generally good engineering practices. These rules have prompted cooperatively funded activities in the process and allied industry sectors which focus on the preparation of technical documents that describe and define methodology, procedures, and techniques that constitutes "recognized and good engineering practices." The first document developed in this activity was expected to be completed and available in early 2000.

Meanwhile, the OSHA training center has continued to offer the NBS-developed training course on hazard analysis to its inspectors. So far, the course has been held 11 times, and about 230 inspectors have attended it.

Harry McHenry retired in 1999 as the Chief of the Materials Reliability Division (the successor to the Fracture and Deformation Division). Bob Shives retired from the Metallurgy Division in 1992, but continues as a Guest Researcher, working on hardness standards. David Read continues as a Physicist in the Materials Reliability Division and is now studying the mechanical behavior of thin films. David McColskey continues as a Physical Scientist in the Materials Reliability Division and is now studying acoustic emission and the behavior of thin films. Charles Brady retired from the Metallurgy Division in 1988, and Patrick Purtscher left NIST in 1999 to become an Engineer with the Portsmouth Naval Yard in Portsmouth, New Hampshire.

Prepared by Tom Siewert.

Bibliography

- [1] Harry I. McHenry, T. Robert Shives, David T. Read, J. David McColskey, Charles H. Brady, and Patrick T. Purtscher, *Examination of a Pressure Vessel that Ruptured at the Chicago Refinery of the Union Oil Company on July 23, 1984*, NBSIR 86-3049, National Bureau of Standards, Boulder, Colorado (1986).
- [2] H. I. McHenry, P. T. Purtscher, and T. R. Shives, Observations of Hydrogen Damage in a Failed Pressure Vessel, *Corros. Sci.* **27**, 1041-1057 (1987).
- [3] H. I. McHenry, D. T. Read, and T. R. Shives, Failure Analysis of an Amine-Absorber Pressure Vessel, *Mater. Perform.* **26** (8), 18-24 (1987).

Curing Those Uncontrollable Fits of Interaction

Expect: Curing Those Uncontrollable Fits of Interaction [1] was the seminal paper on Expect, a software tool for automation of other software. The Expect software itself was a solution to a long-standing problem: how to automate software designed to be operated by a human. There are very good reasons for automating software. An obvious one is testing—if a piece of software only works when a human is interacting with it, testing it is very expensive. Another problem is that humans are rather “unreliable.” Repeating an interaction for the 10th time, people won’t be paying nearly as much attention as they might have on the first and second times.

Many software applications have control languages, preferences, settings, and other mechanisms for providing automated control. Macros are just one modern example of such programmability. However, before Expect each application used a different such language, if any. This meant that users had to learn lots of languages, one for each application. And in many cases, languages were quite limited or totally nonexistent.

Expect combined several ideas. The first was a general purpose control language. No more would people have to learn a new language for every application. The second idea was providing an effective simulation of a human pressing keys at a keyboard. Surprisingly, many programs are quite sensitive to whether a human is there or not—and understandably. For instance, a program intended to accept passwords doesn’t want people scripting them since there is a loss in security because embedded passwords are readable by others. Such programs go out of their way to prevent automation. Not surprisingly, many programs could be entirely automated—except for their passwords. But even if the programs were used in secure settings, the programs offered no way of bypassing this manual step.

Perhaps entering a single password doesn’t sound time consuming. But imagine creating passwords each semester for fifty thousand students. Or logging in (including entering passwords) to configure several hundred network routers. Or test them. And so on.

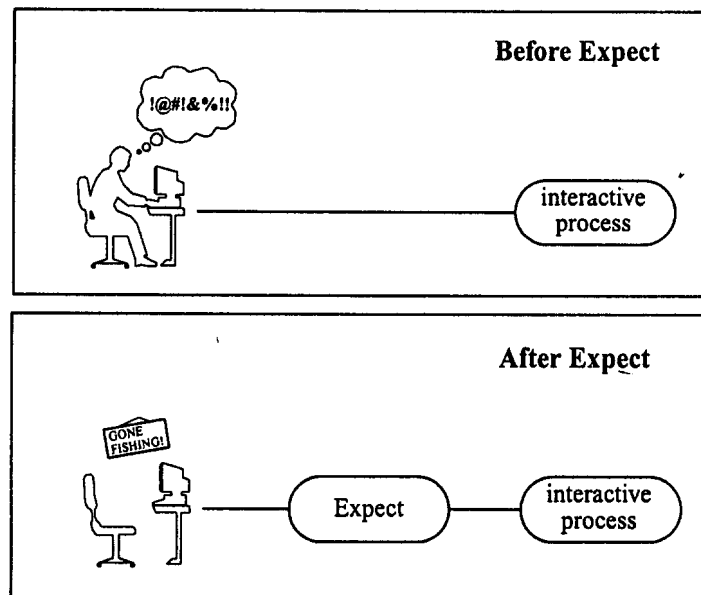

Passwords were just one example. Many programs had all sorts of similarly useless requirements for manual operation. Part of the problem arose from software reuse, often in unexpected ways. One of the hallmarks of any long-lived software is its application in

all sorts of ways unenvisioned by its authors. A good example of this was Expect’s earliest application—in the construction at NBS of a semi-automated factory [2]. This factory was constructed of dozens of one-of-a-kind pieces of hardware and lots of software. Much of the

associated software had been written in the context of separate projects, which made perfect sense at the time. It was hard enough to design and develop a robot at all, much less to design and develop a robot that worked in a complex factory. Expect was used as a kind of glue that integrated many of the pieces together. It wasn't a network or a communications protocol, but merely plugged the many assorted holes that the Automated Manufacturing Research Facility software designers had written in for themselves.

At the prestigious 1990 Summer Usenix conference in Anaheim, California, this paper announced the development of the Expect software to a world that was ripe for such automation software. The paper not only described how Expect solved the general problem but it included a dozen classes of software problems that were solved by Expect in order to make sure that readers could walk away with ideas for immediate application to their own environment.

Publication of the paper spurred use of Expect dramatically; NBS saw downloads of Expect hit 4000 in its first year. The bulk of these downloads were .com and .edu sites, but also included 90 U. S. military sites and 170 U. S. federal sites. Two years later, downloads were in the hundreds of thousands of sites, aided by other users making Expect available on network

gateways in Australia, Netherlands, Germany, Japan and other countries. Now Expect is bundled with many CD and DVD software distributions and vendor-supplied operating system releases.

Ultimately, the *Curing* paper [1] became a base upon which further exploration and development occurred. Hundreds of other papers, as well as textbooks, graduate theses, technical courses, and other writings followed, each describing Expect as an essential element of various research projects as well as crucial in day-to-day operations. A sampling of Expect's published uses include quality assurance, network measurements, automated file transfers and updates, tape backups, automated queries to multiple heterogenous online databases, computer security sweeps, network router/bridge/repeater/server configurations, test instrument simulation, account administration, stock price retrieval, 500-user simulation, control of unreliable processes, and library management.

Subsequent to the original development of Expect, additional work at NIST continued, including innovative ideas such as automatically generating control systems by watching real interactions (Autoexpect) and wrapping legacy line-oriented systems with modern GUIs without any change to the underlying application (Expectk).

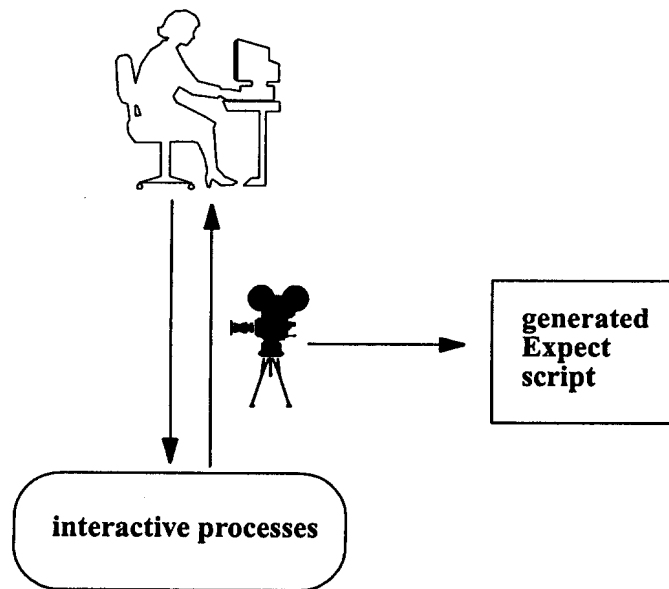

Autoexpect: Automating Automating

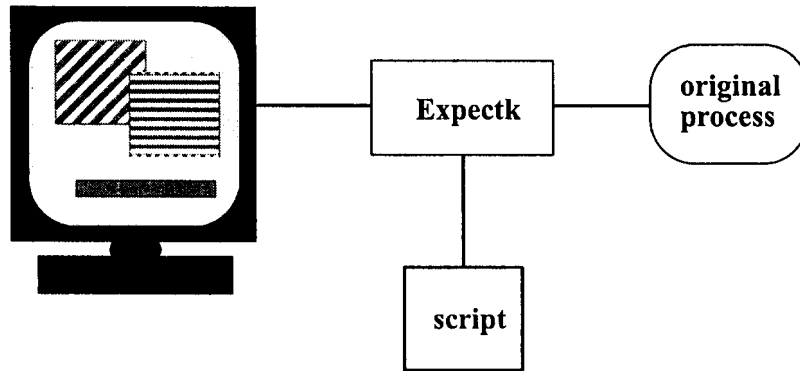

Expectk: Gluing GUIs onto legacy applications

As the figure suggests, the Autoexpect paper had a strange but accurate title. The full title was *How to Avoid Learning Expect—or—Automating Automating Interactive Programs* [3]. As with the Curing title,

many of the Expect papers and topics used humor as a very effective writing technique. Perhaps the most amusing title was applied to a retrospective paper on Expect titled:

Writing a Tcl Extension in Only ~~Three~~ ^{Four} ~~Five~~ ⁷ Years

Because of its odd typography, the *Writing a Tcl Extension* paper was almost impossible to cite correctly, but nonetheless was given the Best Paper Award at the conference where it was presented.

The final development of the *Curing* paper was the publication of the book *Exploring Expect* [4]. Not surprisingly, the book contains significant novel material

in its 602 pages. Yet despite being a comprehensive tome, its origins can clearly be traced back to the *Curing* paper. The book appeared in numerous Best Books of the Year lists and has now become the normative reference, superseding the *Curing* paper as the standard citation for the Expect technology.



The paper and book were written by Don Libes, a computer scientist at NBS/NIST. He has written approximately 100 computer science papers and articles plus several textbooks. Besides *Exploring Expect*, he also wrote two classics in the UNIX literature: *Life With UNIX* [5] and *Obfuscated C and Other Mysteries* [6].

Recognition of Expect and the related papers is also demonstrated by various non-government awards that Don earned, including the Award for Excellence in Technology Transfer, Federal Laboratory Consortium (1998), two Best Presentation Awards, USENIX Association (1996, 1997), Best Paper Award, USENIX Association (1997), Federal 100 Award, FOSE & FCW (1993), Innovation Award, International Communications Association (1992), and Tcl Achievement Award, Tcl Consortium (2000).

Prepared by Don Libes.

Bibliography

- [1] D. Libes, expect: Curing Those Uncontrollable Fits of Interaction, in *Proceedings of the Summer 1990 USENIX Conference*, Anaheim, CA, June 11-15, 1990, (<http://expect.nist.gov/doc/seminal.pdf>).
- [2] C. Furlani, E. Kent, H. Bloom, and C. Mclean, Automated Manufacturing Research Facility of the National Bureau of Standards, in *Proceedings of the 1983 Summer Computer Simulation Conference*, Vancouver, BC, Canada, July 11-13, 1983.
- [3] Don Libes, How to Avoid Learning Expect—or—Automating Automating Interactive Programs, in *Proceedings of the Tenth USENIX System Administration Conference (LISA X)*, Chicago, IL, September 30—October 4, 1996, (<http://expect.nist.gov/doc/autoexpect.pdf>).
- [4] Don Libes, *Exploring Expect: A Tcl-Based Toolkit for Automating Interactive Programs*, O'Reilly & Associates, Inc., Sebastopol, CA (1995), (<http://www.oreilly.com/catalog/expect>).
- [5] Don Libes and Sandy Ressler, *Life With UNIX: A Guide for Everyone*, Prentice Hall, Englewood Cliffs, NJ (1989).
- [6] Don Libes, *Obfuscated C and Other Mysteries*, John Wiley and Sons, New York (1993).

Baldrige Criteria for Performance Excellence

In the 1980s, there was a growing realization by many business analysts and consumers that the quality of U.S. products and services was falling behind that of other leading nations, especially Japan. Some industry and government leaders saw the need for an emphasis on quality as a necessity for doing business in an ever expanding, and more demanding, global market. Many American businesses either did not understand the quality problem or did not know where to begin. Some U.S. business leaders, noting the success of the Deming Prize in improving the quality of Japan's products, suggested that a U.S. quality award might create an incentive for quality improvement and a basis for sharing information on successful quality strategies.

A difficult choice for a U.S. award was whether it should be managed by a private or government entity. Some argued that only those directly experienced in business could provide the needed understanding. Others believed that only a Presidential Award could bring the needed national visibility and recognition. The final decision was to utilize the strengths of both sectors. The pending legislation called for a public-private partnership in which each sector plays a crucial role. In August 1987 Congress enacted legislation establishing the Malcolm Baldrige National Quality Award and assigned overall management of the Award to the National Bureau of Standards (soon to become the National Institute of Standards and Technology). Congress selected NBS/NIST to design and manage the Award program because of its role in helping U.S. companies compete, its world renowned expertise in measurement quality and quality assurance practices, and its reputation as an impartial third party. NIST worked with key private sector leaders to create a private organization, the Foundation for the Malcolm Baldrige National Quality Award. In 1988, the Foundation raised \$10M to support the purposes of the Award.

Congress named the award in honor of Malcolm Baldrige, Secretary of Commerce during the period when the legislation was developed. Just prior to the enactment of the legislation, Mr. Baldrige died after a rodeo accident. This naming was in recognition of the efforts of Secretary Baldrige to strengthen U.S. competitiveness. The Award is the country's highest level of recognition for performance excellence and has been presented annually by the President since 1988.

The intent of the Award is to recognize U.S. companies for their achievements in quality and business performance and to raise awareness about the importance of quality and performance excellence as a competitive edge. It was envisioned that the Award would serve as a standard of excellence to aid U.S. companies in achieving world-class quality. Rather than recognize specific products or services, the Award Program would recognize role-model business practices and emphasize the sharing of best practices. Three Award categories were initially permitted: manufacturing, service, and small business.

A key step in implementing the new Law was developing the criteria for the Award. In late 1987, NBS/NIST created the basic criteria concept and category structure as well as the basis for a multi-stage evaluation. In parallel with this Award design, a network of private sector experts was created to implement and expand the design and to serve as evaluators. A design feature of the Award Program was the commitment to annual revision of the criteria to reflect key learnings and changing business needs. The first Award Criteria were published in *the Application Guidelines for the Malcolm Baldrige National Quality Award* in 1988. [1]

Although the criteria were needed to serve as a basis for making Awards, their use was intended mainly for organizational self-assessment and improvement. The 1988 Application Guidelines included Award Criteria based upon seven evaluation Categories. Each Category consisted of two or more Examination Items, which serve as the basis for Awards and for self-assessment. The Award Criteria represented a major new vehicle for the United States to define best quality practices and to disseminate practices more quickly using an approach that permits self-diagnosis. Thus the Criteria serve as the focal point in education and cooperation, going beyond the requirements of the Award contest, via a kind of excellence standard.

The Criteria take a systems approach to organizational excellence. They incorporate a set of core values and concepts that reflect beliefs and behaviors found in high performing organizations. The Criteria are expressed as operational requirements, including key processes and measures that connect processes to comprehensive business results. The business results include not only financial and market results, but also product

and service quality, public responsibility, employee development, and other key requirements. Accordingly, the Criteria provide a common language for businesses—large and small, manufacturing and service. A key characteristic of the Criteria is that the requirements are nonprescriptive—they do not require the use of specific tools and techniques. Users of the Criteria are asked to demonstrate success via well-defined processes and outstanding results. In this way, successful tools, techniques, and processes are identified and used as a basis for sharing.

Starting in 1998, the Baldrige Award was opened to health care and education organizations. In order to accommodate to these communities, while supporting cross-sector cooperation, the business Criteria were adapted and published for health care and education organizations [2,3]. The adaptation of the Criteria to health care and education is largely a translation of the requirements language and basic concepts of business excellence to parallel requirements in health care and education excellence. The common framework for all sectors of the economy has resulted in cross-sector cooperation and sharing of best practice information.

Although the Baldrige Award and the Award recipients are the very visible centerpiece of U.S. quality improvement, a broader national quality program has evolved around the Award and the Criteria. A 1995 report, *Building on Baldrige: American Quality for the 21st Century*, by the private Council on Competitiveness, said, “More than any other program, the Baldrige National Quality Award is responsible for making quality a national priority and disseminating best practices.” [4].

“The Baldrige public/private partnership has accomplished more than any other program in revitalizing the American economy,” said Barry Rogstad, president of the American Business Conference and past chairman of the Baldrige Program’s Board of Overseers.

Following are some highlights of the program’s first decade:

- Called the “single most influential document in the modern history of American business,” almost 2 million copies of the *Baldrige Criteria for Performance Excellence* [1] have been distributed. This number does not include many hundreds of thousands of copies available in books, from state and local award programs, or downloaded from the Award’s World Wide Web site.
- For the past six years, a hypothetical stock index made up of publicly-traded U.S. whole companies that have received the Baldrige Award has significantly outperformed the Standard & Poor’s (S&P) 500 Index.
- State and local quality programs—most modeled after the Baldrige program—have grown to over 50 in 1999. The national network of awards and sharing of practices involves several thousand volunteers each year.
- Internationally, 45 quality programs are in operation. Most are modeled after the Baldrige Award Criteria and evaluation approach, including a new award established in Japan in 1996.
- Baldrige criteria and case studies are used extensively in U.S. business schools.

Prepared by Curt Reimann and Debbie Smyth.

Bibliography

- [1] *Application Guidelines, Malcolm Baldrige National Quality Award, 1988*, Baldrige National Quality Program, National Institute of Standards and Technology, Gaithersburg, MD.
- [2] *Health Care Criteria for Performance Excellence, 1998*, Baldrige National Quality Program, National Institute of Standards and Technology, Gaithersburg, MD; most recent edition 2000.
- [3] *Education Criteria for Performance Excellence, 1998*, Baldrige National Quality Program, National Institute of Standards and Technology, Gaithersburg, MD; most recent edition 2000.
- [4] *Building on Baldrige: American Quality for the 21st Century*, Council on Competitiveness, Washington, DC (1995).

The Advanced Technology Program

The Advanced Technology Program (ATP) is a competitive cost-sharing program in which the Federal Government works in partnership with industry to foster the development and broad dissemination of challenging, high-risk technologies that offer the potential for significant, broad-based economic benefits for the nation. This unique government-industry research partnership fosters the acceleration not only of dramatic gains in existing industries, but also of the development of emerging technologies leading to revolutionary new products, industrial processes and services for the world's markets while working to spawn industries of the 21st century. ATP's focus on civilian technologies offers the potential for substantial increases in productivity and competitiveness of firms; provides consumers with new, better, and lower-cost products and services; and increases high-wage employment in the United States.

From 1990 through 1999, the ATP made multi-year awards for a total of 468 projects, including over 157 joint ventures, involving more than 1,000 participants (not including the many subcontractors and informal partners and collaborators that participate in many of the projects). These projects entail approximately \$3.0 billion of research, of which industry committed slightly more than half (\$1.53 billion).

Since its inception, the Program's direct and indirect impacts have been substantial. In its brief existence, the ATP has helped shape the face of long-term enabling technology development undertaken by industry. It has also developed, by necessity, a wide variety of new tools for evaluating the impact of technology investment on the economy. Furthermore, it has often provided expertise at an important juncture—staff members, who are often leaders in their field, provide the critical insights to their peers necessary to assess how a certain technology has evolved and describe its potential future trajectories.

The *ATP Proposal Preparation Kit* [1] was the means by which the program has been introduced to the public. Its publication in 1990, as well as subsequent editions, spelled out the ATP's selection criteria and provided a manual for submitting a proposal. It was developed by the ATP specifically to help the public understand the program and addresses ATP's selection criteria. In the first year, nearly 1,000 copies of these guidelines were distributed to potential proposers; by the time the competition began for the year 2000, requests topped

50,000 copies. With such wide distribution, the kit serves many purposes: it informs the public of the nature of the program, answers questions about the program, and supplies all of the necessary information to complete an application, offering "one-stop shopping" for the potential proposal writer. From the outset, the *Proposal Preparation Kit* has undergone annual revisions to reflect both the needs of the public and the changes to the program.

The *Proposal Preparation Kit* has had widespread impact; to date, the rules contained within it have influenced the formation of almost 4,500 project teams. As such, it has changed the face of long-term technology development considered by industry. While the ATP has funded approximately 10 % of these proposals, anecdotal evidence suggests that the kit was influential in fostering collaboration even when proposals were not funded.

A critical part of the ATP program management has been the development of methodologies and tools for assessment of impact and broad-based economic benefits. The ATP relies on the presence of expected private returns to induce companies to plan, propose, and cost-share research with the government. If the research is successful in overcoming its technical hurdles, the ATP relies on awardees to pursue commercial development of the new technology with private capital. The ATP applies its criteria to the proposals it receives to identify those projects expected to accomplish ATP's public-interest mission and objectives. Selected projects must demonstrate that they have the potential to generate social rates of return (the return to the nation) far in excess of the private rates of return on investment. In addition, selected projects must demonstrate that, without ATP funding, the private sector would be unwilling to do the research in either a timely fashion or a scale needed to realize the social benefit potential.

A study conducted by economist William F. Long [2], an ATP contractor, provides the most detailed examination to date of the outcomes of the earliest ATP projects. The study covers all 38 ATP projects completed by the end of March 1997. It documents research accomplishments and highlights subsequent work by the participants to commercialize the results. It also provides near-term outlooks for the technologies. In the high-risk environment in which the ATP-funded projects operate, failure is to be expected. Thus the report also highlights the

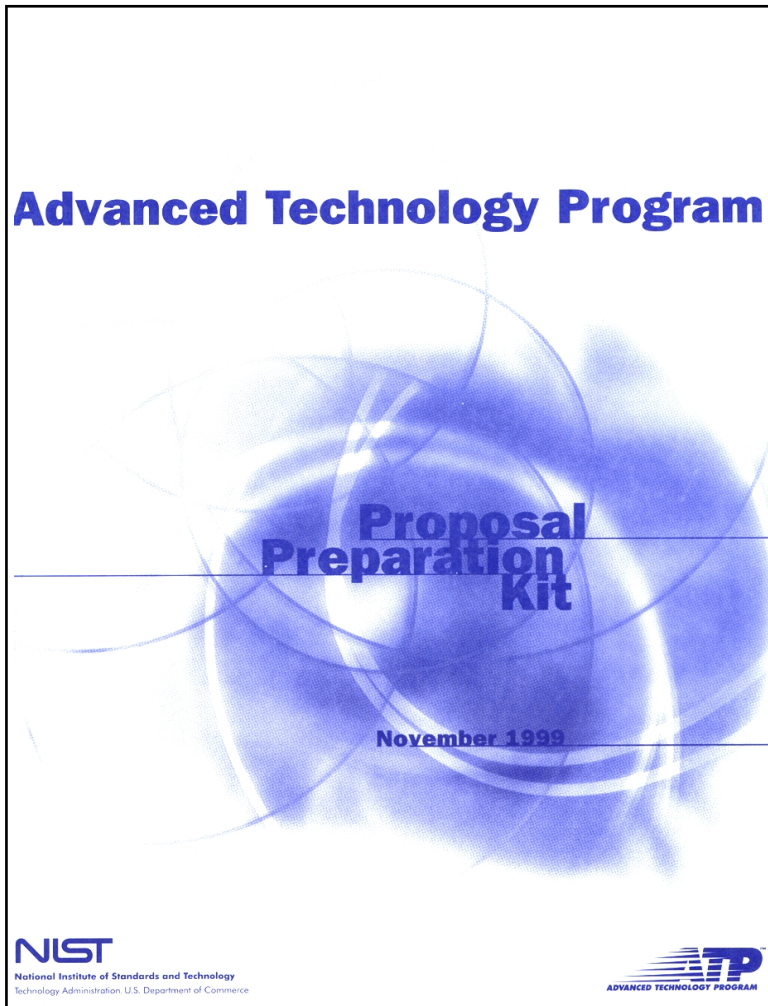

Fig. 1. ATP Proposal Preparation Kit.

reasons for failure of 12 terminated projects that had been selected between 1991 and March 1997.

The 38 projects surveyed by Long cover a broad range of ATP investments. The technologies were distributed over seven broad areas—chemicals and chemical processing; materials; discrete manufacturing; energy and environment; biotechnology; information, computers and communication; and electronics—with the majority in electronics. Industry participants provided \$65.7 million, a little more than half the funding, while the ATP contributed \$64.6 million to the 38 projects.

Notable new technologies highlighted by Long include a merger of tissue-engineering and textile-weaving to help regenerate lost or damaged tissue in the body, an application of high-temperature superconductors to improve cellular phone service, and a suite of process-monitoring and control technologies that are cutting costs and improving quality throughout much of

the U.S. auto industry. Other new technologies developed under the projects ran the gamut from a desktop bioreactor capable of growing large amounts of human stem cells isolated from bone marrow for cell replacement therapy, a device now in clinical trials; to a computer programming tool to simplify the task of writing software for parallel-processing computers, which already is in commercial use; to a new navigation system for mobile robots which is being used to guide delivery robots in hospitals.

This analysis shows that technical success has not always led to commercial success. In a few cases, financial reverses or corporate takeovers left technically successful projects in abeyance. In other cases, commercialization activities are expected to take longer. For example, projects with medical applications generally had yet to be widely applied because they must go through a long process of clinical trials.

Other projects, however, have shown strong early returns. The process-monitoring and control technologies for the auto body industry, developed by a consortium of large and small companies, have been adopted in more than half of the Chrysler and General Motors plants in the United States and Canada. When the technologies are fully implemented, annual savings in production costs are expected to range from \$65 million to \$160 million for one of the most important U.S. industrial sectors.

A project pursued by one small start-up company developed a novel technology for processing very large semiconductor wafers, allowing the United States to be the first in the market with processing equipment for the next generation of 300 mm semiconductor wafers. A small New Jersey firm developed a new laser light source, which is the most powerful tunable source of laser light over much of the ultraviolet spectrum, and already has incorporated it in three new products for laser surgery and other applications.

The Long study is influential because it is among the first to demonstrate through a systematic assessment of the ATP portfolio the breath of the impact of the public investment undertaken by the ATP. In his introductory comments for the report, former Commerce Secretary William Daley characterized the report's influence by stating, "this new study fills in the details behind the statistical analyses of the ATP and demonstrates the overall success of the program. These pages say that the ATP is working. Industries as diverse as biotechnology, electronics, manufacturing and software have new technologies in place, today, that they wouldn't have had here and now without the ATP. The projected benefits to the nation's economy from just three of these early ATP projects would pay for every ATP project funded to date." Daley concluded by stating, "this report is a portrait of a program that works."

Since the ATP funds the research underlying the development of enabling technologies that are expected to have benefits extending substantially beyond the direct ATP award recipient, impact evaluation remains a challenge. Even under the best of circumstances, technology diffusion takes time, and tracking and measuring externalities, or spillover effects, is often complicated and difficult. As such, program and project assessment requires that the ATP go well beyond such traditional measures as return-on-investment, firm profitability, or increased tax revenues. Available evaluation tools often are insufficient to meet the task.

A special issue of the *Journal of Technology Transfer* [3] highlights a collection of ATP evaluation studies and illustrates the variety of evaluation issues ATP faces. The works in the publication are among the first to demonstrate the conceptual challenges ATP is faced

with and the wide variety of tools developed by the ATP. That publication features articles on methodology, the evaluation program, results from the path-breaking ATP "Business Reporting System" database, survey-based research, and a macroeconomic impact study. Other papers in the volume examine the effects of collaboration, special concepts that need to be considered in examining social benefits, and counterpart programs in the industrialized world.

In the *Journal of Technology Transfer* issue [3], Adam Jaffe, of Brandeis University, reflects on the importance to the ATP of generating and measuring "economic spillovers." It illustrates with simple models how the benefits of ATP projects may extend beyond the direct ATP award recipients through market and knowledge spillover effects. The paper also discusses network spillovers. Jaffe recommends that the ATP fund projects for which expected social benefits are large and substantially exceed expected benefits to the awardees. He recommends that evaluation efforts include measures of spillover effects. This paper is influential in that it affected the way in which the Advanced Technology Program, as well as others, undertakes economic analysis. Jaffe's paper codified the economic concepts used by the ATP and has served as a springboard for many other research projects underway.

Rosalie Ruegg the Director of the Economic Assessment Office of the ATP, provides an overview of the ATP, explains how the program operates, how it seeks to accomplish its mission, and what it has funded to date. She identifies the major components of ATP's evaluation program and identifies research areas of particular interest. The program is internationally recognized and has made a substantial impact in the evaluation community. In the United States, Congress has directed other agencies to model their evaluation programs on the ATP. Furthermore, state governments seek assistance from ATP in establishing their evaluation programs.

Jeanne Powell from the ATP presents and analyzes data from ATP's "Business Reporting System" database to evaluate short and medium term project effects. She describes ATP's principal data collection tool and identifies a number of pathways through which ATP-funded technologies are generating impact. The enabling nature of the funded technologies is suggested by the many potential applications that have thus far been identified. The survey-based database employed in this study is unique because it is among the first in the world that allows a researcher to explore the inner-workings of firms and technology projects at such a magnitude. As such, the tools used in this paper serve as the basis for future evaluation efforts.

ATP's effects on the speed with which research is conducted and technology is commercialized are examined by Frances Laidlaw. Laidlaw questions not only whether, and by how much, the ATP accelerates research, but also the value of acceleration; whether saving time during the research stage translates into saving time downstream; and whether project participants realize any time-related benefits outside the walls of the project. This paper demonstrates that acceleration of technology development and commercialization is one of several ways that the ATP can affect economic outcomes of the projects it funds.

The researchers at CONSAD Research Corporation report on a detailed case analysis performed for an ATP-funded research joint venture whose focus was on new dimensional control technology for discrete manufacturing. They analyze the multiple impacts of the new technology applied in the automobile manufacturing sector and apply a macroeconomic model to project national economic impacts resulting from quality improvements in vehicles made by U.S. producers. This paper demonstrates the feasibility of a macroeconomic input-output model dealing with the impact of technological innovations.

Other relevant issues are discussed in this series. Albert Link, a Professor of Economics at the University of North Carolina at Greensboro investigates the effects on research efficiency of collaboration in an ATP-sponsored joint venture. Also, Andrew Wang examines the special considerations that need to be undertaken in modeling the social benefits of medical technologies. Finally, Connie Chang of the ATP office, signals ATP's interest in counterpart programs that operate in most industrialized countries.

Prepared by Robert Sienkiewicz and Richard N. Spivack.

Bibliography

- [1] *Advanced Technology Program Proposal Preparation Kit*, National Institute of Standards and Technology, Gaithersburg, MD, November 1999.
- [2] William F. Long, *Advanced Technology Program Performance of Completed Projects: Status Report Number 1*, NIST Special Publication 950-1, National Institute of Standards and Technology, Gaithersburg, MD (1999).
- [3] Symposium on Evaluating A Public-Private Partnership: The Advanced Technology Program, Special issue of *J. Technol. Transfer*, Vol. 23, no. 2, Summer 1998.

NIST Manufacturing Extension Partnership

The NIST Manufacturing Extension Partnership (MEP) is a nationwide network of locally managed centers offering technology assistance and the latest business practices to help smaller manufacturers improve their competitiveness. The MEP was created in 1988 as a new extramural responsibility assigned to NIST by the Omnibus Trade and Competiveness Act—the same Act that changed NBS into NIST. At the heart of MEP is a network of more than 400 manufacturing extension centers and field offices located throughout the country. The program became operational in 1989, and today's network delivers services to manufacturers in all 50 states and Puerto Rico. The 1999 report to Congress, *The NIST Manufacturing Extension Partnership, A Network for Success* [1], summarizes the progress in the first decade of MEP.

More than 385,000 small and mid-sized manufacturers make vital contributions to the economy. About 98 % of the nation's manufacturers are small to medium-sized, defined as having fewer than 500 employees. They supply more than 50 % of the added value in U.S. manufacturing and employ nearly 12 million people. That accounts for 65 % of all U.S. manufacturing workers with high-skilled, high-wage jobs, paying an average 58 % more than the average retail earnings.

As large manufacturers depend more on suppliers for parts and services, the performance and capabilities of smaller manufacturers become even more critical. Yet, according to a National Research Council report, "Many of these small firms . . . are operating far below their potential. Their use of modern manufacturing equipment, methodologies and management practices is inadequate to ensure that American manufacturers will be globally competitive." Limited budgets, lack of in-house expertise, and lack of access to the newest technologies are but a few of the significant barriers faced by smaller manufacturers—barriers that MEP helps firms overcome.

MEP centers are local resources serving their local markets. Linked together through the National Institute of Standards and Technology's Manufacturing Extension Partnership, they are part of a national network of manufacturing and business experts. They exist as the result of a partnership among the federal government, state and local governments, and industry to help local manufacturers. They are created through a competitive,

merit-based process where funding is contingent upon successful annual reviews of each center. MEP centers are supported by contributions from public and private organizations that match federal funding.

While part of a national network, MEP centers are independent, non-profit organizations. They offer products and services that meet the specific needs of the region's local manufacturers. Each center works directly with area firms to provide expertise and services tailored to their most critical needs, ranging from process improvements and worker training to business practices and applications of information technology. Solutions are offered through a combination of direct assistance from center staff and work with outside consultants. MEP centers are staffed by knowledgeable manufacturing engineers and business specialists who typically have years of practical experience gained from working on the manufacturing floor and/or managing plant operations. MEP center staff also know the local business community and the available local resources, and they can access national resources through the MEP network. As a result, centers help small firms to overcome barriers in locating and obtaining private-sector resources.

MEP centers work with companies that are willing to invest time, money, and/or human resources to improve their business. Typical MEP clients include manufacturers who:

- Have been unable to locate the proper resources or technologies they need.
- Want expert, impartial advice in helping them evaluate alternative solutions.
- Need help solving a specific problem, such as determining the cause of product defects, modifying plant layout to improve workflow, or establishing employee training.
- Want assistance in reversing negative business situations—such as sales decreases, loss of market share, or cost increases.
- Want to implement new technologies or processes that will help establish them as market leaders.
- Seek to improve their ongoing business operations for peak performance.

Through these centers, MEP provides small and mid-sized manufacturers with access to a wealth of tools, techniques, and other resources from over 2,500 public and private affiliations. Initiatives with the U.S. Departments of Labor and Agriculture, EPA, Small Business Administration, National Association of State Development Agencies, the Kauffman Center for Entrepreneurial Leadership, and hundreds of universities and community colleges are but a few examples of how MEP leverages public and private resources to make a comprehensive range of technical services and assistance available to small manufacturers.

The report to Congress [1] includes a section on evaluation, which is a key element of all MEP programs and activities. Results are used to assess the effectiveness of services and their impact on the performance of client firms and to help guide planning at both the center and national levels. By measuring short- and long-term impacts, MEP can also assess economic returns on the federal investment in manufacturing extension services.

Results of ongoing surveys confirm that MEP services—delivered to more than 84,000 small and mid-sized manufacturers since 1989—are yielding sizable benefits. For example, a sample of 4,554 client companies reported that, as a direct result of MEP assistance during 1998, they:

- Created or retained a total of 7,186 jobs
- Increased revenues by \$294 million
- Invested a total of \$291 million in modernization
- Realized a cost savings of \$29 million in materials and labor
- Reduced inventories by \$20 million.

Other independent studies have also yielded solid evidence of performance and economic benefits. An analysis by the U.S. General Accounting Office found that a substantial majority of firms using extension services, including those provided by the MEP, credited this assistance with helping them to improve productivity, product quality, customer satisfaction, profits, and other critical facets of their operations.

Since the program's inception in 1989, MEP has recognized the value and impact small manufactures have on our everyday lives. Whether through national initiatives such as the Y2K Conversion 2000 Jumpstart kit—distributed to more than 320,000 manufacturers throughout the country—or through local contact, MEP is providing hands-on help to America's small manufacturers. One significant way that MEP does this is

through education on lean manufacturing. As a result of a partnership between MEP's centers and Productivity, Inc., the smaller manufacturers have access to "lean manufacturing" training previously available only to large companies. Originating in Japan in the 1970's, lean manufacturing is a concept that eliminates manufacturing activities or actions that add no real value to the product or service. Field manufacturing specialists at NIST MEP centers around the country receive training in lean manufacturing through the partnership.

Several success stories that show the impact that the MEP centers have had on American manufacturers across the country through various products and/or services are included in the report [1]. A typical example is the case of Contine Corp., located in Erie, Pennsylvania, which employs 28 people in its 15,000-square-foot facility and offers a full range of job shop services to manufacturers of electromechanical devices. The company added plastic injection molding capabilities after purchasing Bayside Precision Inc. in 1990, which further enhanced its ability to serve the market. Contine was concerned about its Y2K preparedness for internal and external systems. The company recognized that it might need to replace or upgrade software and/or hardware, but it neither had a plan nor did it know where to start. For assistance, Contine contacted the Northwest Pennsylvania Industrial Resource Center (NWIRC), a NIST MEP network affiliate.

NWIRC's information technology field engineer met with Contine systems staff and proposed that the company undergo a Y2K awareness briefing. After the briefing, Contine asked NWIRC to initiate a full Y2K readiness project and to assume the role of project director for the company's Y2K team. NWIRC installed MEP's Y2K project tool and trained the team how to use it. Throughout the next 3 months, the Center met regularly with the team to evaluate progress and establish new landmarks. The results of the identification and testing of Contine's systems indicated that the company needed to spend approximately \$50,000 to replace its existing network server and "jobshop" software applications. After NWIRC talked with various outside consultants and evaluated the inner-workings of their information systems, it determined that the company also should upgrade five of its workstations to improve productivity.

Within 2 months, Contine purchased, installed, and tested the new equipment and software while the team continued to conduct on-going Y2K readiness testing. The new technology allowed Contine to enhance its capabilities and increase its efficiency for Y2K and for years to come. In addition, as a result of the company's

efforts to assure its Y2K readiness, it was able to prevent disruption of the flow of products to customers, which in turn protected the employees from short- and long-term layoffs.

Prepared by Anita O'Brien.

Bibliography

- [1] *A Report to Congress- The NIST Manufacturing Extension Partnership, A Network for Success*, Manufacturing Extension Partnership, National Institute of Standards and Technology, Gaithersburg, MD, July 1999.

Questions and Answers on Quality

Product quality depends on many process variables, such as the caliber of the components or materials used; type of equipment used in design, production, handling, installation, testing and shipping; the equipment calibration and maintenance procedures; the training and experience of production and supervisory personnel; the level of “workmanship”; and sometimes the environmental conditions (temperature, humidity, level of dust particles) in the area where the product is produced. The process, organizational structure, procedures, and resources that manufacturers and suppliers use to control these variables to produce a product or service of consistent quality to meet defined specifications is called a quality system.

In 1979, the International Organization for Standardization (ISO), a worldwide federation of over 90 countries founded in 1946 to promote the development of international standards to facilitate the exchange of goods and services worldwide, formed Technical Committee (TC) 176 on Quality Management and Quality Assurance. The Committee’s purpose was to address the worldwide trend towards increasingly stringent customer demands with regard to quality. This committee was tasked with addressing the growing confusion in the conduct of international trade resulting from differing quality system requirements at national and lower jurisdictional levels. As a result of TC 176’s work, ISO released a series of five standards in 1987, the ISO 9000 Standard Series. These standards provided guidance on selection of and requirements for a basic quality management system.

Soon compliance with the standards became recognized and required by many foreign and domestic buyers and by some governmental regulators. In addition, quality system registration was seen and used by manufacturers as a competitive marketing tool.

Quality system registration or approval entails the assessment and periodic audit of the adequacy of a supplier’s quality system by a third party, known as a quality system registrar. When a supplier’s system conforms to the registrar’s interpretation of an ISO 9000 standard, the registrar issues the supplier a “certificate of registration.” It should be noted that it is the supplier’s quality system that is registered, not an individual product.

This increasing demand for compliance with or registration to the ISO 9000 standards, combined with the lack of adequate and accurate information on the

topic, created significant problems for both U.S. industry and government agencies. To fill this void, NIST published two basic primers on the ISO 9000 Series and the usage of the ISO standards. The two reports, *Questions and Answers on Quality, the ISO 9000 Standard Series, Quality System Registration, and Related Issues* [1] and *More Questions and Answers on the ISO 9000 Standard Series and Related Issues* [2], addressed such issues as: the types of requirements included in the standards; how the U.S. registration system operates; how the ISO 9000 standards were being used in the European Union’s new regulatory scheme; mutual recognition efforts at the international level; how federal agencies were using the standards within their regulatory and procurement programs; and information on other ISO 9000 based standards, such as the QS 9000 Standard—a standard published by the auto industry to define a set of quality system requirements for suppliers to the “Big Three” and other auto companies.

The ISO 9000 Standards increased the visibility of and U.S. concerns over the impact of international standards on U.S. competitiveness to a degree never encountered before. The NIST reports provided timely and accurate information that was sorely needed by both the private and government sectors to formulate adequate responses to these issues—information not being provided by the private sector at that time. The reports were written in an easy-to-read question-and-answer format, providing information in a way managers could use to make informed decisions regarding the application of the ISO 9000 Standard Series within company and governmental operations.

The use of the ISO 9000 standards is now a key domestic and international business strategy for many U.S. companies—one that is becoming increasingly necessary for survival. U.S. industry has become acutely aware that information on these and other national and international standards and related conformity assessment activities is vital to ensure continued competitiveness in the U.S. and global marketplaces.

The *Questions and Answers on Quality* reports have been and continue to be widely distributed by NIST and by private sector companies and educational institutions. The popularity of and demand for these reports far exceeded anything that the Office of Standards Services had anticipated or had ever experienced.

These reports are part of NIST's growing effort to respond to the need for accurate and timely information on subjects related to national and international standards and conformity assessment. Other related reports are listed on the Office of Standards Services web site [3]. NIST has also formed federal working groups to address such issues, has responded to many thousands of requests for information on these topics, and has provided staff members to give lectures at numerous workshops and at various public and private sector fora.

Maureen Breitenberg is internationally recognized as a leading authority on conformity assessment issues, standards, guidelines and practices. Her many publications have been used nationally and internationally to address trade-related issues. They have been widely distributed by NIST to private sector organizations, other U.S. federal agencies, state agencies involved in trade development and assistance, U.S. embassies, foreign governments, colleges, universities, and libraries for education and training purposes and for responding to trade related inquiries. Several have been translated and/or reprinted by foreign and domestic government and private sector organizations. Her latest publication, the 1999 edition of SP 739, *Directory of Federal Government Certification and Related Programs* [4], has been highlighted as a very useful resource in terms

of depth of content, authority, and how well the information is presented.

Breitenberg received the NIST Bronze Medal in 1992. She was also elected to the Government and Industry Quality Liaison Panel's Leadership Team, which resulted in harmonizing federal agency quality system requirements for suppliers to the government. The Panel received the Vice President's National Performance Review (Golden Hammer) Award in 1995 for its efforts.

Prepared by Maureen Breitenberg.

Bibliography

- [1] Maureen Breitenberg, *Questions and Answers on Quality, the ISO 9000 Standard Series, Quality System Registration, and Related Issues*, NISTIR 4721, National Institute of Standards and Technology, Gaithersburg, MD (1991).
- [2] Maureen Breitenberg, *More Questions and Answers on the ISO 9000 Standard Series and Related Issues*, NISTIR 5122, National Institute of Standards and Technology, Gaithersburg, MD (1993).
- [3] NIST publications on standards and conformity assessment activities are listed on the web site (<http://ts.nist.gov>).
- [4] Maureen Breitenberg (ed.), *Directory of Federal Government Certification and Related Programs*, NIST Special Publication 739, 1999 Edition, National Institute of Standards and Technology, Gaithersburg, MD (1999).

Uniformity in Weights and Measures Laws and Regulations

Today we take it for granted that when we buy a pound of hamburger, whether we are in New York, St. Louis, or California, we will be getting the same amount of product for our money. A hundred years ago consumers could not be so sure that a “pound” in one state was the same as a “pound” in another. Concerns about the uniformity of weights and measures standards and laws from state to state led the National Bureau of Standards to convene the first “Conference on the Weights and Measures of the United States” in January 1905. This first meeting laid the foundation for the creation of the National Conference on Weights and Measures (NCWM), which continues to this day. The NCWM is the primary mechanism used by NIST to fulfill its responsibility, as stated in its Organic Act, to work with the states “in securing uniformity in weights and measures laws and methods of inspection.” Only 11 delegates attended the first Conference; however, there are now over 3,000 NCWM members representing state and local weights and measures jurisdictions, the Federal Government, industry, consumers, and other countries.

NBS published the report of the 1905 Conference and has since published the reports of the 83 other Conferences held since that first meeting [1]. The reports document the history of the NCWM’s development of standards in the form of model weights and measures laws, regulations, and practices. When state and local weights and measures jurisdictions adopt these standards, they become mandatory. The reports of the Conference serve as a legislative history of the requirements in the model laws; therefore, state officials, the NIST Office of Weights and Measures, Federal and international standards agencies, members of the public, and others often consult the reports to identify the intent of the requirements. The reports contain a wealth of technical and historical information, including special addresses by NCWM Chairmen and by NBS/NIST Directors, who have served as Honorary Presidents of the NCWM. It would not be practical to describe all the reports in this centennial book; however, particular attention is called to the report of the first Conference because of its historical significance. In addition, it contains a history of U.S. weights and measures from the beginnings of the country up to 1905. This historical information was used as the basis for later

NBS publications, such as SP 447, *Weights and Measures Standards of the United States, A Brief History* [2].

Over the years, the uniform laws, regulations, and practices developed by NIST in cooperation with the NCWM have been gathered together and published in a series of NIST Handbooks. Two Handbooks of particular note are Handbook 44, *Specifications, Tolerances, and Other Technical Requirements for Weighing and Measuring Devices* [3], and Handbook 130, *Uniform Laws and Regulations, in the areas of legal metrology and engine fuel quality* [4].

Handbook 44 was first published in 1949, having been preceded by similar handbooks of various designations and in several forms, beginning in 1918. This Handbook has become the standard for specifications and tolerances for commercial weighing and measuring devices in the United States. These devices include scales, liquid-measuring devices, volumetric measures, linear-measuring devices, mass flow meters, grain moisture meters, timing devices, near infrared grain analyzers, and multiple dimension measuring devices. All 50 states have adopted the Handbook as the legal basis for regulating commercial weighing and measuring devices. It is updated by NIST each year following the Annual Meeting of the NCWM to include changes adopted at the meeting. A NIST staff member serves as Technical Advisor to the NCWM Specifications and Tolerances Committee, which recommends changes and additions to the Handbook. Nearly 3,000 copies of the Handbook are distributed annually to NCWM members. Another thousand copies are sold through the Government Printing Office and hundreds of copies are distributed to Depository Libraries throughout the country. In addition, many associations reprint portions of the Handbook to distribute to their members. In a number of states, commercial weighing and measuring device servicepersons and agencies are required to demonstrate their knowledge and understanding of the Handbook in order to be registered by the states. The significance of the Handbook is further indicated by the fact that it serves as the basis for the National Type Evaluation Program (NTEP), a cooperative effort of NIST and the NCWM. NTEP evaluates models of weighing and measuring devices to determine if they meet the requirements of Handbook 44. Forty-four

states require that only weighing and measuring devices with an NTEP Certificate of Conformance can be installed in commercial applications in the state. (Fig. 1)

NIST Handbook 130 compiles the latest uniform laws and regulations and related interpretations and guidelines adopted by the NCWM. In 1979, NBS issued the first compilation of the various laws and regulations that had been adopted by the NCWM under the title "Model State Laws and Regulations." The name of the publication was later changed to make it clear that the standards in the publication were recommended for adoption by

local as well as state jurisdictions. Handbook 130 is the standard for uniform weights and measures laws and regulations in the United States. It has been estimated that weights and measures laws and regulations impact transactions involving \$4.5 trillion (52.8 %) of the \$8.51 trillion U.S. Gross Domestic Product (1998 figures). NIST technical advisors, working with members of the NCWM Laws and Regulations Committee, have helped develop and maintain the standards in Handbook 130. These standards have been widely adopted by the weights and measures community. For



Fig. 1. A New Mexico Weights and Measures Inspector tests a Liquefied Petroleum Gas Meter to determine its compliance with NIST Handbook 44 requirements.

example, 44 states have adopted a Weights and Measures Law based on the uniform law in Handbook 130. As of 1999, 45 states have adopted Packaging and Labeling requirements and 42 states have adopted Method of Sale requirements based on the uniform regulations in Handbook 130.

Prepared by Joan Koenig.

Bibliography

[1] Reports of the National Conference on Weights and Measures 1905—1999. Various editors over the years. Latest report: Henry

V. Oppermann and Joan Koenig (eds.), *Report of the 85th National Conference on Weights and Measures*, NIST Special Publication 957, National Institute of Standards and Technology, Gaithersburg, MD (2000).

[2] Lewis V. Judson, *Weights and Measures Standards of the United States, A Brief History*, NBS Special Publication 447, National Bureau of Standards, Washington, DC (1976).

[3] *Specifications, Tolerances, and Other Technical Requirements for Weighing and Measuring Devices*, NIST Handbook 44 (various editors over the years; editors of the 2001 edition: Tina G. Butcher, Terry L. Grimes, and Juana Williams).

[4] *Uniform Laws and Regulations, in the areas of legal metrology and engine fuel quality*, NIST Handbook 130, (various editors over the years; editors of the 2001 edition: Thomas Coleman and Terry L. Grimes).

Certification of 10 μm Diameter Polystyrene Spheres (“Space Beads”)

There are numerous examples in trade and commerce in which small particles play an important role, either as the commodity of trade itself, as unwanted contaminants in a product or an environment, or as a basis for comparison between a “normal” particle and an “abnormal” one. Many of the products we buy come in the form of small particles, powders, or particle suspensions, including medicines, cosmetics, food products, paints, talcum powder, cements, photocopier toners, and milk (which is essentially a suspension of microdroplets of fat in water). In other cases, small particles are unwanted, for example in cleanrooms for microelectronics or pharmaceutical manufacturing, in lubricating oils in motor vehicles, and in the air we breathe and the water we drink. There are also situations where one would like to compare a known, standard particle to an unknown, test particle as in the case of blood-cell testing. In all of these instances, particle standards play a key role, enabling quality control, product uniformity, conformance to standards, traceability to NIST, interchangeability of instrumentation, uniformity of measurement, or some combination of these goals.

With these benefits in mind, the National Bureau of Standards set out, in the early 1980’s, to develop a range of particle-sizing Standard Reference Materials (SRMs) for use in calibrating and certifying instruments that measure particle size, whether as products, by-products, or contaminants. In cooperation with ASTM Committee E-29 on Particle Size Measurement, researchers in the Precision Engineering Division (PED) at NBS developed a series of five SRM’s consisting of monosized polystyrene microspheres with diameters of 0.3, 1, 3, 10, and 30 μm [1-4]. The three smallest particles, donated by commercial vendors, were certified first, since such small microspheres were comparatively easy to grow using conventional polymer emulsion techniques. However, for the two larger diameters, 10 μm and 30 μm , the techniques that existed at the time did not yield rigid particles of the required sphericity because of the detrimental effects of gravity on the microsphere growth process. (At the time, there were techniques to make large microspheres, but these were relatively soft and unsuitable for use as SRMs, which must be rigid and stable.)

At about the same time that NBS was certifying its series of particle-sizing SRMs, a group of researchers led by John Vanderhoff of Lehigh University and

Dale Kornfeld of NASA Marshall Space Flight Center was conducting experiments aboard the space shuttle to determine the effect of microgravity on chemical reaction rates of emulsion polymerization, as well as on the morphology (shape) of polymer microspheres grown in microgravity [5]. The first experiments of the Monodisperse Latex Reactor (MLR) were conducted in 1982 aboard space shuttle flight STS-3 and resulted in microspheres as large as 5 μm in mean diameter. A subsequent experiment on a later shuttle flight, STS-6, produced particles of 10 μm mean diameter. In 1984, the NBS group obtained samples of the 5 μm and the 10 μm materials and did a detailed intercomparison between the space-made particles and earth-made particles of similar composition [1,2]. In both cases, the space-made materials were found to be superior in terms of individual particle sphericity, narrowness of size distribution, and, importantly, in particle rigidity. An agreement was then made between NASA and NBS for NASA to provide a sufficient quantity of the 10 μm material to make up 600 5 mL vials containing liquid suspensions of the polystyrene microspheres for use as an SRM. The agreement also called for NBS to receive the 30 μm polystyrene spheres to be grown on a subsequent shuttle flight.

To certify SRM 1960, the so-called “space beads” (Figs. 1 and 2), researchers at NBS, led by Tom Lettieri of the PED, developed three new particle-sizing techniques, which are described in the publication *Certification of SRM 1960: Nominal 10 μm Diameter Polystyrene Spheres (“Space Beads”)* [1]. These techniques were center distance finding (CDF), resonance light scattering (RLS) from a liquid suspension of microspheres, and metrology electron microscopy (MEM). The primary certification technique for SRM 1960, center distance finding, was developed by Ike Hartman of the PED. CDF uses a conventional optical microscope and relies on the fact that the microspheres act like tiny lenses when placed on a glass slide in the microscope. The microspheres were spread onto a slide such that they formed long chains of contacting spheres, rather than the regular hexagonal arrays formed in conventional array sizing. This ensured that the particles were in close contact, compared to conventional array sizing where the non-zero diameter distribution of the microspheres leads to voids, cracks, gaps, and other flaws in the arrays. These flaws lead to uncertainties in

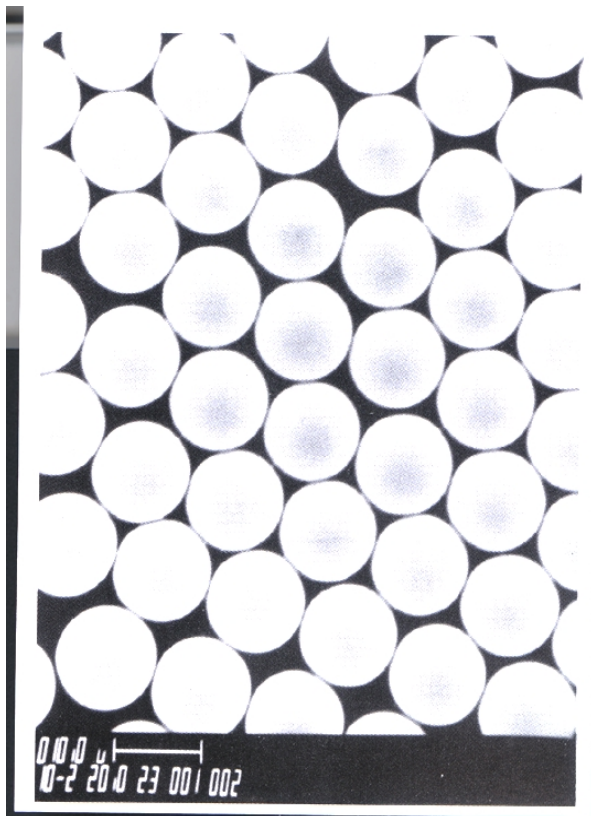

Fig. 1. Scanning electron photomicrograph of Standard Reference Material 1960 microspheres.

the mean sphere diameter measured with conventional array sizing, uncertainties that are avoided when particle chains are used. If the microspheres are illuminated from below and the microscope is focused just above them, then the tiny focal spots can be photographed and the distance between the spots determined very accurately. Using CDF, the mean sphere diameter for SRM 1960 was determined to be 9.89 ± 0.04 mm: this was the certified mean diameter for the SRM.

Supporting measurements were made using RLS and MEM. In the RLS technique, developed by Tom Lettieri, a tunable dye laser was used to generate resonance light-scattering intensity patterns from the microspheres as they were suspended in water. As the laser was tuned through its wavelength range, relatively sharp peaks in the light-scattering intensity appeared at certain wavelengths. Although this technique had been used before by others to investigate sharp resonances from single microspheres, this was the first time that such resonances were detected in a suspension of many microspheres: this could be done because the spheres had a very narrow size distribution ($<1\%$ standard deviation). By comparing the experimental resonance wavelengths with those calculated by Egon Marx of the

PED using Mie scattering theory, the NBS researchers were able to use RLS to arrive at a mean diameter of 9.90 ± 0.03 μm for the SRM 1960 microspheres. This result was in excellent agreement with those from both CDF and MEM.

The other supporting metrology technique was MEM. Gary Hembree of the PED used MEM to measure the microspheres in a scanning electron microscope (SEM). With MEM, the spheres are mounted onto the microscope stage as in a conventional SEM. However, in a conventional SEM the electron beam is raster-scanned past the stationary spheres, whereas in the MEM technique developed at NBS, the electron beam is held stationary while an individual particle is moved through the beam via a piezoelectric scanning stage. The scattered electron intensity is measured versus stage position and, from this, a particle profile is generated. These profiles could then be used to determine the diameter of the individual particles. Using MEM, a mean diameter of 9.89 ± 0.06 μm was obtained for the SRM 1960 spheres, in excellent agreement with the other two metrology techniques. Indeed, the remarkable agreement among the three metrology techniques, and the relatively small uncertainty in the diameter, likely made SRM 1960 the best characterized particle-size standard in the world at the time. An important point in these measurements was that the three metrology techniques were independent of each other, in that none of the measurements relied in any way on measurements from the other techniques. This is always good practice when certifying an SRM.

In 1985, SRM 1960 was first offered for sale to the public through the NBS Office of Standard Reference Materials (OSRM), making the SRM the first commercial product to be manufactured in space (SRM-1961, the nominal 30 μm spheres, was the second space-made product). The sale of the space beads was reported in hundreds of newspapers, magazines, and television/radio news stories around the world, from the *New York Times* to the CBS *Nightly News* to ABC's *Good Morning America*. The work was also featured on a National Public Radio program and on an Australian science show, *Beyond 2000*. Later on, SRM 1960 won an IR-100 award from *Research & Development* magazine for being among the top 100 products of 1985.

Over the years, SRM 1960 has proven to be a valuable tool for the calibration of particle-sizing instruments in the United States and around the world. Samples have been purchased by dozens of U.S. and foreign companies for use as primary particle-sizing standards. These companies include not only the makers of particle-sizing standards and instrumentation, but also "every day" users who need to maintain accuracy and traceability of their measurements. Among the primary users are

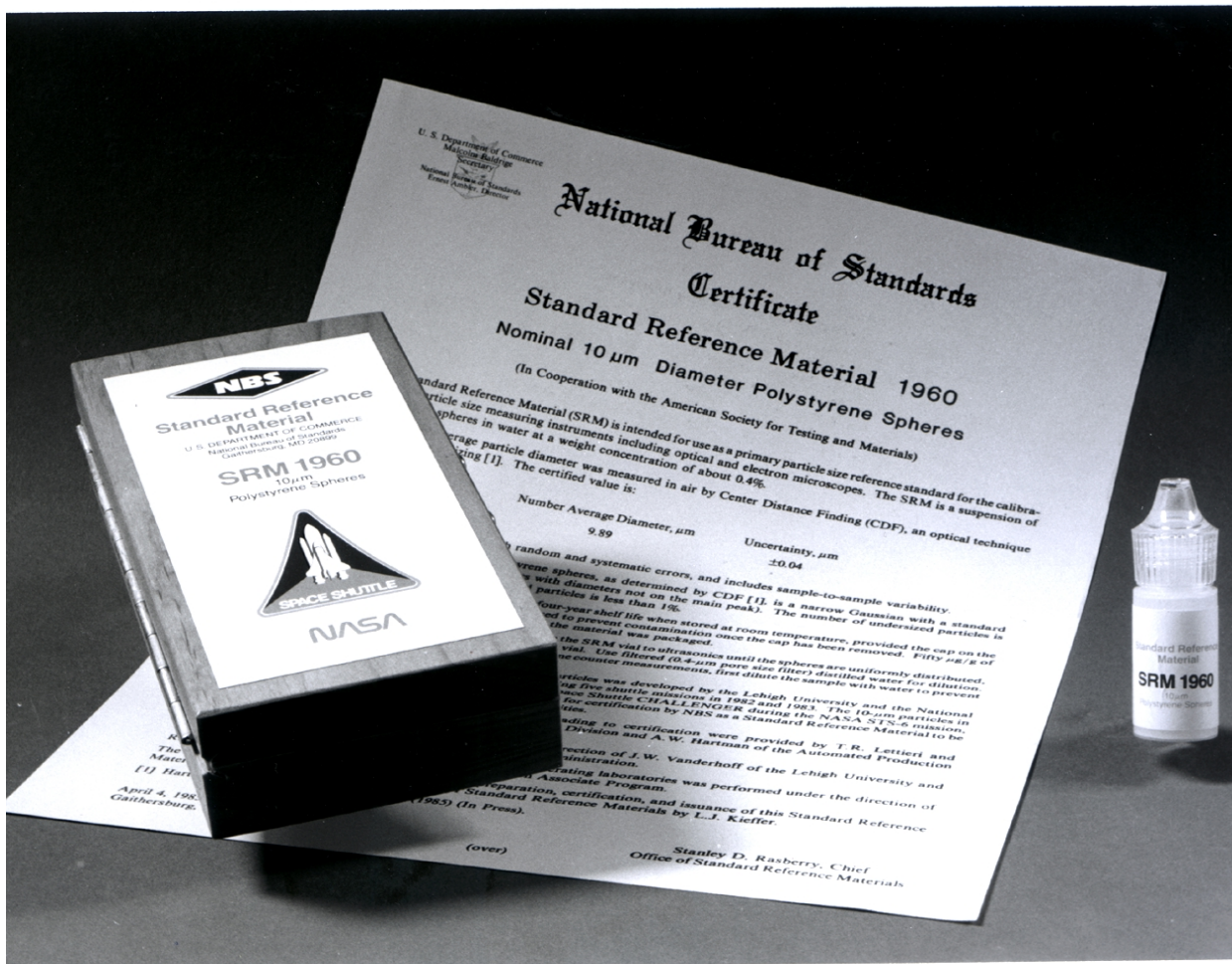

Fig. 2. Photograph of SRM 1960 showing a vial of the SRM, the certificate, and the package.

major pharmaceutical companies, Fortune 500 petrochemical and chemical companies, small-to-mid-sized biomedical instrumentation companies, particle standard supply houses, and numerous firms, of all sizes, involved in the measurement of particle size. Several U.S. Government and non-profit labs, including NASA Ames, Battelle Northwest, EPA, FDA, Los Alamos, Sandia, and the USGS have also purchased SRM 1960. In the international arena, the material has been used by research laboratories in Australia, Austria, Brazil, Canada, England, France, Germany, India, Italy, Japan, Korea, Mexico, Norway, Spain, Switzerland, and Thailand. Sales of SRM 1960 average about 25 vials per year through the NIST OSRM. The OSRM also offers for sale another version of the space beads, SRM 1965, which are standard microscope slides with small patches of particles in both regular arrays and microsphere chains. These have been used throughout the world for educational and training purposes, as well as to satisfy the needs of those who wish to own something

“made in space.” In addition to OSRM, the microspheres are also sold through the European Community’s Bureau Communautaire de Reference (BCR).

The demand for SRM 1960 is spurred, in part, by its incorporation into several document standards in the United States. For example, the U.S. Pharmacopeia, in its test entitled “Particulate Matter in Injections,” specifies the use of SRM 1960 for calibrating the liquid-borne particle counters used in the test. As a water-quality standard, SRM 1960 is listed by the National Oceanic and Atmospheric Administration (NOAA) in its compilation of *Standard and Reference Materials for Marine Science* as a physical standard for the assessment of water and sediment quality. The particles have also found application in the monitoring and assessment of air quality, especially with regard to the Environmental Protection Agency (EPA) PM₁₀ standard that specifies a cutoff of 10 µm for the aerodynamic diameter of particulate emissions from motor vehicles, smokestacks, and

other industrial emission sources. In the medical field, SRM 1960 has been valuable as a calibration standard for blood-cell counting and sorting, as the mean diameter of the SRM is very near that of human red blood cells. Thousands of hospitals and medical testing laboratories throughout the U.S. use blood-cell counters to check for sickle cell anemia, Tay-Sachs disease, and other blood abnormalities, and SRM 1960 helps to ensure the quality and accuracy of such tests. SRM 1960 will, undoubtedly, find more applications in the medical field as biotechnology and medical diagnostics become more pervasive in our daily lives.

In addition to the above applications of SRM 1960, other areas of scientific research where the material has found use include: electron microscopy; chemical chromatography; powder metallurgy; ceramics; food processing; photographic films; and basic particle research, among many others. The rigid demands of ISO9000 will likely increase the importance of particle-sizing standards such as SRM 1960, as companies become more concerned with quality control, conformance assessment, and reliability issues.

Of the four authors of the space beads paper, two, Tom Lettieri and Egon Marx, are still at NIST. Tom started at NBS in 1978 after graduate school at the University of Rochester, joining the Pressure Group to do high-pressure optical studies of liquids. Less than two years later, he joined the PED to conduct optical metrology studies of small particles, rough surfaces, and noncontact methods for dimensional measurement. Tom is now a Program Manager with the NIST Advanced Technology Program, where he helps select and manage industrial technology projects in the area of optics/photonics. Egon Marx did his graduate studies in nuclear physics under the direction of Murray Gell-Mann at the California Institute of Technology. After a few years of teaching at Drexel University,

Egon went to work at Harry Diamond Laboratories, conducting theoretical investigations in electromagnetic (EM) interference. His interests at NIST have included EM scattering, surface roughness, linewidth metrology, and quantum electrodynamics. Two authors, Gary Hembree and Ike Hartman, left NIST not long after the space beads project was finished. Gary came to NBS after completing graduate studies in electron microscopy at Arizona State University (ASU). After several years at NBS, he returned to ASU to work with the world-renowned electron microscopy group there. Ike Hartman came to NBS after spending a number of years at General Electric doing optics and imaging research. At NBS, he worked in various areas of optical metrology, including microscopy, particle sizing, electro-zone particle counting, and linewidth metrology. He retired from NIST after a long and satisfying career in optics, both in his native Netherlands and in the United States.

Prepared by Tom Lettieri.

Bibliography

- [1] T. R. Lettieri, A. W. Hartman, G. G. Hembree, and E. Marx, Certification of SRM 1960: Nominal 10 μm Diameter Polystyrene Spheres ("Space Beads"), *J. Res. Natl. Inst. Stand. Technol.* **96**, 669-691 (1991).
- [2] G. Mulholland, G. Hembree, and A. Hartman, *Sizing of Polystyrene Spheres Produced in Microgravity*, NBSIR 84-2914, National Bureau Standards, Gaithersburg, MD (1985).
- [3] T. R. Lettieri, Optical Calibration of Accurate Particle Sizing Standards at the U.S. National Bureau of Standards, in *Optical Particle Sizing: Theory and Practice*, Gérard Gouesbet and Gérard Grehan (eds.), Plenum Press, New York (1988).
- [4] Nancy M. Trahey (ed.), *NIST Standard Reference Materials Catalog 1998-1999*, NIST Special Publication 260, National Institute of Standards and Technology, Gaithersburg, MD (1998).
- [5] D. Kornfeld, *Monodisperse Latex Reactor (MLR)*, NASA TM-86847, NASA, Washington, DC (1985).

Bose-Einstein Condensation in a Dilute Atomic Vapor

An unavoidable consequence of quantum mechanics is that, for sufficiently short length scales, all objects appear to be “wavy.” We do not notice this effect in our everyday lives because, for objects larger than an electron, the length scale over which the waviness occurs is fantastically short, far too small to be observed by the unaided eye. Nature makes an exception to this rule, however, in the case of extreme cold. As objects are cooled very close to absolute zero, their characteristic quantum-mechanical wavelengths become increasingly long. This tendency towards ever-expanding wavelength culminates in a dramatic phenomenon known as “Bose-Einstein Condensation” (BEC).

BEC was originally conceived in 1925 by Albert Einstein, who calculated that if a gas of atoms could be cooled below a transition temperature, it should suddenly condense into a remarkable state in which all the atoms have exactly the same location and energy—in modern language, the wave-function of each atom in a Bose-Einstein condensate should extend across the entire sample of gas. For a dilute gas, the requisite transition temperature is so low as to be unachievable by the technology of Einstein’s day. By the 1980s and early 1990s, however, cooling techniques had advanced to the point where a number of experimental groups around the world felt emboldened to attempt to realize Einstein’s original vision. Many of the necessary advances came from NBS/NIST atomic physics laboratories. The first successful creation of dilute-gas BEC, announced in the NIST publication *Observation of Bose-Einstein Condensation in a Dilute Atomic Vapor* [1], was both a natural continuation of a 75-year tradition of NBS pre-eminence in spectroscopy (which is detailed in several other entries in this book [2-5]) and a striking confirmation that present-day NIST research is at the cutting edge of modern technology.

The scientific motivation to create and study BEC in a gas stemmed from the long-held belief that the mechanism underlying BEC is the same mechanism responsible for the mysterious effects of superconductivity and superfluidity. Indeed, in the broadest sense the electrical currents that flow (without resistance) in a superconducting metal and the liquid currents that persist (without viscosity) in superfluid helium are basically Bose condensates. But liquids and solids are much more complicated than the relatively simple gas-phase system that Einstein first envisioned, and it is

not easy to connect the elegant mechanism that Einstein proposed with the complex behavior of solids and liquids. If one could create a Bose condensate in a gas, it was reasoned, one would have a well-characterized model system, a system that might illuminate the counter-intuitive behavior of its liquid and solid predecessors.

The technical motivation for creating a BEC was equally compelling. Much of the standards and metrology work that NIST is charged with performing relies on precise spectroscopy of various internal resonances in atoms. When it comes to spectroscopy, the general rule of thumb is “colder equals more accurate.” Colder atoms move more slowly, which means they can be probed longer, with correspondingly narrower resonance lines. In addition, systematic errors are often more easily controlled at lower temperatures. For a gas of atoms, the natural and obvious limit of improved cooling is exactly the Bose-condensed state. Thus from both technological and scientific viewpoints, there were compelling reasons to push the techniques of refrigeration to the ultimate limits with the goal of creating BEC.

The first condensates were formed at NIST at temperatures well under a microkelvin. To reach these unprecedented temperatures required a two-stage cooling technique. The first stage of refrigeration is provided by laser cooling. Of the three or four most prominent players in the development of laser cooling, two (David Wineland and Bill Phillips) are long-standing Bureau scientists; two of their most influential papers are described in this volume [6,7]. As powerful as laser cooling is, it is not sufficient on its own to reach BEC temperatures. The second stage of cooling is known as evaporative cooling. The laser-cooled atoms are collected in a magnetic trap (another NIST development [8]) which provides near-perfect thermal isolation from the surrounding environment. Via a technique known as rf evaporation [9], the trapped atoms with the most energy are ejected from the magnetic trap. The remaining atoms have, on average, less energy per atom, and are therefore colder. After evaporation has cooled the atoms to a temperature perhaps another factor of a hundred colder than the laser-cooled sample, the condensate begins to form.

The presence of condensates was originally detected by velocity-distribution information observed in time-of-flight images. The magnetic fields used to confine

the atoms were very suddenly turned off. The residual thermal and quantum energy of the atoms caused them to fly apart. After a brief delay, the atoms were illuminated with a strobed flash of laser light, and their image was captured on an electronic screen. The atoms with large thermal velocities in the trapped cloud ended up far from the center of the image; atoms with relatively low velocities did not travel as far during the delay time and contributed to the central portion of the recorded density. Fig. 1 shows a series of three such images; from left to right they correspond to images taken of three clouds at progressively lower temperatures [10]. In the left-most image, the atoms are not yet condensed; the distribution of velocities is well approximated by a conventional Maxwell-Boltzmann thermal distribution. In the center image, the condensate has begun to form; the central spire corresponds to the near-stationary atoms of the condensate. The final, right-most cloud is a near-pure condensate. The central feature amounts to a photographic image of a single, macroscopically-occupied quantum wavefunction.

The original observation of BEC in a gas of atoms occurred in June of 1995. A few months earlier, several groups (most notably the NIST/CU collaboration in Boulder, and groups at Rice University and at MIT) were very close to achieving Bose-Einstein condensation. All three groups presented their progress in invited talks at the May 1995 meeting of the American Physical Society. The audience was left with the impression that the long-standing goal of BEC might be realized quite

soon. There was a pronounced sense of keen, but good-spirited, competition that added to the general anticipation felt in the physics community.

Ultimately, the NIST group prevailed and its paper [1] appeared, as the cover article, in *Science* magazine on July 14th, 1995. In the same issue, *Science* also ran a “perspective” piece by Keith Burnett, of Oxford University, in which he referred to the achievement of Bose-Einstein condensation as a sort of “Holy Grail” of physics. The announcement of Bose-Einstein condensation attracted an unusual amount of attention from the lay public. There were front-page articles in the *Washington Post*, the *New York Times* and the *Los Angeles Times*, and even professional entertainers made remarks about scientists creating new states of matter. The scientific press was also duly impressed: the work was written up in all the major science magazines; the paper won the AAAS Newcomb-Cleveland award; and in December 1995 *Science* deemed BEC the “Breakthrough of the Year.”

In the years immediately following NIST’s breakthrough result, there was an enormous surge of interest in the field of BEC. Within a few months, the group at MIT had successfully created a sample of BEC over a hundred times larger than the initial NIST result [11]. Theoretical calculations performed at NIST predicted that the condensate clouds should support standing-wave acoustic modes [12], with resonance frequencies determined by solutions to a macroscopic quantum wave equation. Within a year, these predictions were

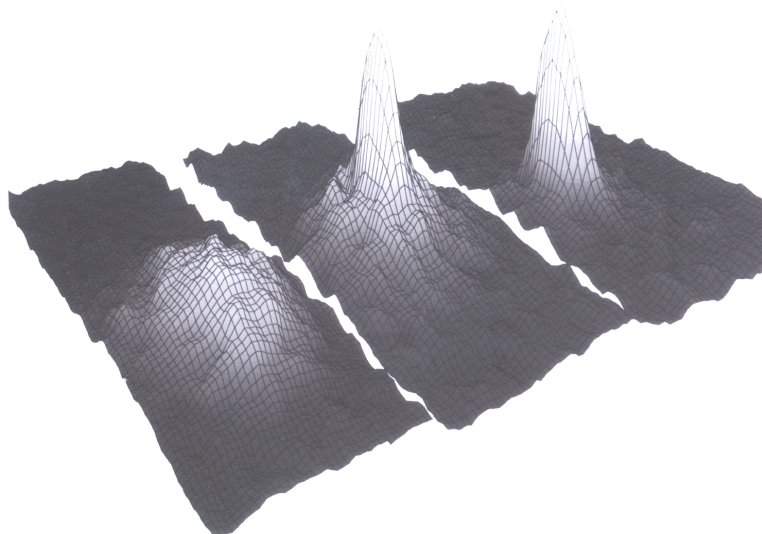

Fig. 1. A series of images of progressively colder clouds of rubidium gas. In the center image, a Bose-Einstein condensation can be seen emerging from the background thermal gas. A color version of this image was featured on the 1996 calendar distributed by the American Physical Society.

experimentally verified by the original NIST group in Boulder [13] and also by the group at MIT [14].

The field of BEC research continues to expand. Around the world, many experimental groups are now capable of producing the substance. For a recent review, see reference [15]. Hundreds of theoretical papers on BEC are published every year. The major atomic physics and low-temperature conferences all have multiple sessions devoted to BEC, and every year a number of specialty workshops are held on the topic around the world. The original experimental paper [1] has now been cited in the scientific literature more than 1000 times, and citations continue to accrue at a rate of more than 200 per year.

The first major application of BEC has been to make possible the development of “atom lasers,” intense beams of coherent atoms which are very analogous to the more conventional “photon lasers” of light. BEC is the starting point for this rapidly evolving technology—after atoms are cooled into a BEC, they are ejected out of the trap in a highly collimated, monoenergetic beam [16, 17].

The longer-term technological and economic significance of BEC and the “atom laser” will never rival that of the optical laser. The ability to create coherent-like beams of atoms will likely find specialized applications, however, in certain high-technology fields: BEC will enhance the capability of very-high-precision, atom-interferometric metrology. On a more speculative note, one could imagine coherent-source atomic lithography being used in certain nanofabrication situations.

Eric Cornell’s graduate work was on precision mass spectroscopy; he received his Ph.D. from MIT in 1990. He began trying to reach Bose-Einstein condensation in the same year. Since 1992 he has been a staff physicist in NIST’s Quantum Physics Division. He is a Fellow of JILA and Professor Adjoint in the University of Colorado Physics Dept. His work in Bose-Einstein Condensation has been recognized by many prizes and awards, including NIST’s Samuel Wesley Stratton Award, the Department of Commerce Gold Medal, the Fritz London Prize in Low Temperature Physics, the King Faisal International Prize in Physics, the Lorentz Medal (Royal Netherlands Academy) and the Benjamin Franklin Medal in Physics. Cornell has also made contributions in the field of atom optics, including developing techniques for guiding beams of atoms through microscopic channels in hollow glass fibers.

Carl Wieman, a professor in the University of Colorado Physics Department and a Fellow of JILA since 1984, is internationally known for his work on parity violation in atomic cesium and for his experiments in laser cooling. He is a recipient of numerous

international prizes and awards. Wieman and Cornell have collaborated on the Bose-Einstein Condensation project since 1990.

Mike Anderson did his graduate work at the University of Colorado and joined Cornell’s group as a postdoctoral fellow in 1993. He left in 1996 to join Meadowlark Optics in Frederick, Colorado; he is currently Vice President of Engineering there. Mike Matthews and Jason Ensher were graduate students in the University of Colorado Physics Department. Matthews is now a staff scientist at 3M in Austin, Texas, and Ensher is currently doing postdoctoral research in ultra-cold molecular physics at the University of Connecticut in Storrs.

Prepared by James Faller.

Bibliography

- [1] M. H. Anderson, J. R. Ensher, M. R. Matthews, C. E. Wieman, and E. A. Cornell, Observation of Bose-Einstein Condensation in a Dilute Atomic Vapor, *Science* **269**, 198-201 (1995).
- [2] W. W. Coblentz, Present status of the determination of the constant of total radiation from a black body, *Bur. Stand. Bull.* **12**, 553-582 (1916).
- [3] C. E. Moore, *Atomic Energy Levels as Derived from the Analyses of Optical Spectra*, NBS Circular 467, Vol. I, National Bureau of Standards, Washington, DC (1949), and subsequent extensions.
- [4] U. Fano, Effects of Configuration Interaction on Intensities and Phase Shifts, *Phys. Rev.* **124**, 1866-1878 (1961).
- [5] K. M. Evenson, J. S. Wells, F. R. Petersen, B. L. Danielson, G. W. Day, R. L. Barger, and J. L. Hall, Speed of Light from Direct Frequency and Wavelength Measurements of the Methane-Stabilized Laser, *Phys. Rev. Lett.* **29**, 1346-1349 (1972).
- [6] D. J. Wineland, R. E. Drullinger, and F. L. Walls, Radiation-Pressure Cooling of Bound Resonant Absorbers, *Phys. Rev. Lett.* **40**, 1639-1642 (1978).
- [7] P. D. Lett, R. N. Watts, C. I. Westbrook, W. D. Phillips, P. L. Gould, and H. J. Metcalf, Observation of atoms laser cooled below the Doppler limit, *Phys. Rev. Lett.* **61**, 169-172 (1988).
- [8] A. L. Migdall, J. V. Prodan, W. D. Phillips, T. H. Bergeman, and H. J. Metcalf, First Observation of Magnetically Trapped Neutral Atoms, *Phys. Rev. Lett.* **54**, 2596-2599 (1985).
- [9] N. Masuhara, J. M. Doyle, J. C. Sandberg, D. Kleppner, T. J. Greytak, H. F. Hess, and G. P. Kochanski, Evaporative Cooling of Spin-Polarized Atomic Hydrogen, *Phys. Rev. Lett.* **61**, 935-938 (1988); D. E. Pritchard, K. Helmerson, and A. G. Martin, Atom Traps, in *Atomic Physics II*, World Scientific, Singapore (1989) pp. 179-197.
- [10] Fig. 1 in this vignette amounts to a three-dimensional rendering of the data presented in Fig. 2 of Ref. 1.
- [11] K. B. Davis, M.-O. Mewes, M. R. Andrews, N. J. van Druten, D. S. Durfee, D. M. Kurn, and W. Ketterle, Bose-Einstein Condensation in a Gas of Sodium Atoms, *Phys. Rev. Lett.* **75**, 3969-3973 (1995).

- [12] M. Edwards, P. A. Ruprecht, K. Burnett, R. J. Dodd, and Charles W. Clark, Collective Excitations of Atomic Bose-Einstein Condensates, *Phys. Rev. Lett.* **77**, 1671-1674 (1996).
- [13] D. S. Jin, J. R. Ensher, M. R. Matthews, C. E. Wieman, and E. A. Cornell, Collective Excitations of a Bose-Einstein Condensate in a Dilute Gas, *Phys. Rev. Lett.* **77**, 420-423 (1996).
- [14] M.-O. Mewes, M. R. Andrews, N. J. van Druten, D. M. Kurn, D. S. Durfee, C. G. Townsend, and W. Ketterle, Collective Excitations of a Bose-Einstein Condensate in a Magnetic Trap, *Phys. Rev. Lett.* **77**, 988-991 (1996).
- [15] W. Ketterle, D. S. Durfee, and D. M. Stamper-Kurn, Making, probing and understanding Bose-Einstein condensates, in *Bose-Einstein Condensation in Atomic Gases*, Proceedings of the International School of Physics—Enrico Fermi, IOS Press, Amsterdam (1999) pp. 67-176; E. A. Cornell, J. R. Ensher, and C. E. Wieman, Experiments in dilute atomic Bose-Einstein condensation, *ibid.*, pp. 15-66.
- [16] M.-O. Mewes, M. R. Andrews, D. M. Kurn, D. S. Durfee, C. G. Townsend, and W. Ketterle, Output Coupler for Bose-Einstein Condensed Atoms, *Phys. Rev. Lett.* **78**, 582-585 (1997).
- [17] E. W. Hagley, L. Deng, M. Kozuma, J. Wen, K. Helmerson, S. L. Rolston, and W. D. Phillips, A Well-Collimated Quasi-Continuous Atom Laser, *Science* **283**, 1706-1709 (1999).

Index

The index includes subjects and names of NBS/NIST staff members mentioned in the accounts of the publications, as well as names of those who prepared the accounts. The page number listed is the starting page of the account.

A

Abramowitz, Milton, 135
AC-DC transfer standards, 90
Achenbach, Paul R. (Reece), 260
acoustic thermometry, 339
acoustics, 53, 69
AD-X2, 129
adhesives, 174
Advanced Technology Program, 359
aerodynamics, 46
Agency for International Development, 230
Ainsworth, E. L., 86
air conditioning, 10, 270
Albus, James S., 237, 322
Alexander, S. N., 86
algorithms, 77, 81, 250
alloys, 14
Ambler, Ernest, 111
American Ceramic Society, 184
ampere, 56
AMRF, 322
analytical chemistry, 97, 164, 188
Anderson, Michael, 375
antennas, 319
Antosiewicz, H. A., 135
Arend, Peter Vander, 107
ASCII, 172
ASHRAE, 260
Astin, Allen V., 59, 230, 291
atomic energy levels, 73
atomic spectra, 73, 116, 200
atomic weights, 194
ATP, 359
Atwater, Wilbur O., 5
Austin, Louis W., 120
autoionization, 116
Automated Manufacturing Research Facility, 322
aviation, 38
Avogadro constant, 194
Ayres, Robert, 209

B

Babrauskas, V., 280
Baldrige Criteria, 357
Barbrow, Louis, E., 174
Barger, Dick, 191
Barnett, Dean, 100
Beck, Charles M., II, 97

Bekkedahl, N., 104
Belanger, Brian, 16, 167
Belecki, Norman B., 5, 56, 63, 90, 315
Bell, R. K., 56, 63, 90, 315
Bentz, Dale, 33
Berk, Norman F., 303
Bernstein, Barry, 126
Bichowsky, F. R., 93
Bicking, George W., 66
Birmingham, Bascom, 107
blackbody radiation, 7, 25
Blandford, Josephine M., 174
Block, Stanley, 100
Bogue, Robert, 33
Boisvert, Ronald F., 135, 140
Boltzmann constant, 339
Borchardt, Bruce, 241
Bose-Einstein condensation, 331, 375
boundary layers, 46
Bowen, R., 309
Boyd, H. S., 19
Brady, Charles, 350
Brady, Edward L., 230, 291
Bragaw, C. L., 120
Branscomb, Lewis M., 135, 230, 234, 291
Branstad, Dennis, 250
Braun, E., 347
Breckenridge, Frank, 69
Breen, Bettijoyce, 254
Breitenberg, Maureen, 366
Brenner, F. Cecil, 174
Brickencamp, Carroll, 167
Brickwedde, Ferdinand G, 43, 107
bridges of Königsburg, 140
Briggs, Lyman J., 1
Bright, Harry Aaron, 97
broadcasting (radio), 16
Brown, E. A., 59
Brown, James E., 344
Brown, Walter E., 309
Building and Housing Series, 22
building codes, 22, 275, 283, 347
building materials, 10, 22
Building Science Series, 260
buildings, 260, 266
Bukowski, Richard, 347
Buntin, Steve, 334
Bunting, E. N., 100
Burgess, G. K., 230, 291
Burns, Grace, 174
Burr, William E., 250

C

CAD/CAM, 246, 322
Cage, Marvin E., 56, 63, 315
Cahill, William F., 135
Cahn, John, 300
Cali, J. Paul, 227
calibration, 129, 227, 230
calorimetry, 93, 178
Cameron, Joseph, 129, 132, 167
candela, 7, 25
Carpenter, B. Stephen, 230
Cavallo, Lucy M., 209
Cavanagh, Rich, 334
Celotta, Robert J., 203
Cement and Concrete Reference Laboratory, 33
cement, 33
ceramics, 181, 184
cerebellar model articulation controller, 237
chain folding, 104
Chamberlain, G. E., 297
Chang, Connie, 359
Charters of Freedom, 66
Chelton, Dudley, 107
chemical analysis, 97, 164, 188
Chemical Information System, 254
chemical kinetics, 224
chemical structure searching, 86
Chemical Thermodynamics Data Center, 93
Chemistry WebBook, 93
Cheok, Geraldine, 140
Chi, J., 270
Chinese postman problem, 140
Churney, Kenneth, 178
Civil Aeronautics Administration, 38
Clark, Al F., 294, 306
Clark, Charles W., 116, 334
Clevinger, Mary A., 184
Coblentz Society, 7
Coblentz, William W., 7, 25
CODATA, 1, 93, 291
Codling, Keith, 116
Collaborative Testing Services, Inc., 66
Collé, Ron, 129, 209
color standards, 25, 145, 174
colorimetry, 25
combinatorial algorithms, 140
compilers, 258
computer-aided manufacturing, 246, 322
computers, 86, 172, 250, 254
concrete, 33
condensed matter physics, 203
Condon, Edward U., 73, 77, 107, 230
configuration interaction, 116
conformance testing, 258
conjugate gradients method, 81
consumer information, 174
control systems, 237
Cook, Richard K., 53, 69
Cooper, J. W., 86
coordinate measuring machine, 241
Cooter, I. L., 63
Coriell, Sam, 14

Corliss, Charles, 73
Corliss, Edith L. R., 174
Cornell, Eric, 375
corrosion, 174
Coursey, Bert, 209
Critchfield, C., 56
critical point, 149, 152
Croarkin, M. Carroll, 129, 132
Cromer, Chris, 178
Cryogenic Engineering Conference, 107
cryogenics, 43, 107, 111, 294
crystallography, 100, 188, 300, 303
Cugini, John, 258
currency, 66
current measurement, 90
Currie, Lloyd, 164, 209
Curtis, H. L., 56
Curtis, R. W., 56
Curtiss, John, 77
Cutkosky, R. D., 56

D

Danielson, Bruce L., 191, 297
data analysis, 132
data encryption, 250
database management, 254, 291
Davis, G. T., 104
Davis, Philip J., 135
Davis, Rich, 339
Davis, Ruth M., 250
Davis, Tom, 104
Day, Gordon W., 191, 297
Dellinger, John H., 16, 120
densitometers, 145
dental research, 309
DeSimone, Daniel, 234
Deslattes, Richard D., 194
desorption, 219
detection limit, 164
deterministic metrology, 241
Deters, Teresa, 73
deuterium, 43
developing countries, 230
diamond anvil pressure cell, 100
Diamond Ordnance Fuze Laboratory, 59
Diamond, Harry, 38, 59
Dickinson, Hobart, 10
Didion, David A., 270
DIET, 219
Digital Library of Mathematical Functions, 135
DiMarzio, E. A., 104
dimensional metrology, 19
direction finder, 38
disaster alleviation, 283, 350
Doiron, Ted, 19, 241
Domalski, Eugene, 93
dopant density, 289
Dowell, Marla, 178
Driscoll, R. L., 56
Drullinger, R. E., 200
Dryden, Hugh L., 46
Dunmore, Francis, 38
Duralumin, 14

dwelling construction, 22
Dziuba, Ronald F., 56, 63, 315

E

economics, 260
Ederer, David, 116
Edmonds, Jack, 140
Edwards, Terry J., 339
Ehrlich, Charles, 167
Eicke, W. G., 315
Eisenhart, Churchill, 129, 132, 167, 241
Ekin, Jack W., 294, 306
Elbourn, R. D., 86
electrical units, 5, 56, 63, 90
electromagnetic wave propagation, 120
electron probe microanalysis, 160
electron sources, 203
electron spectroscopy, 116
electron-stimulated desorption, 219
Electronic Computers Laboratory, 86
Ellingwood, Bruce R., 283
Elmqvist, R. E., 56, 63, 315
Emerson, W. B., 25
encryption, 250
energy conservation, 260, 266, 270
energy, 174
Engel, F. H., 38
Epling, Mary, 132
equation of state, 122
Evans, David, 28
Evans, William, 93
Evenson, Ken, 191
exchange formats, 246
Expect, 353

F

Faller, James, 375
Fano, Ugo, 116, 203
Federal Information Processing Standard, 172, 250
femtochemistry, 334
Ferraris, Chiara, 33
fiber optics, 297
fibers and fabrics, 174
Fickett, Fred R., 294, 306
field emission spectroscopy, 155
field emission, 214
Filliben, James J., 132, 209, 289
Fiori, Charles, 160
FIPS, 172, 250
fire and fire research, 28, 275, 280, 344, 347
fluid properties, 149
Flynn, D. R., 10
Fonoroff, B., 59
Food and Drug Administration, 209
Forman, Richard, 100
Forney, C. L., 347
Forsythe, George, 77, 81
FORTRAN, 258
fracture mechanics, 181, 350
Franzen, Douglas L., 178, 297
Freeman, George, 107

Freiman, Stephen, 181
French, Judson C., 123
frequency measurements, 191
frequency standards, 200, 331
Friedman, D. C., 86
Frohnsdorff, Geoffrey, 33
Frolen, L., 104
Fuhr, Jeffrey, 73
Fuller, Edwin, 181
fundamental physical constants, 1

G

Gadzuk, J. William, 155, 214, 219, 334
gage blocks, 19
Galawa, R. L., 297
Galejs, Anija, 203
gamma rays, 194
Garboczi, Edward, 33
Garfinkel, Samuel B., 209
Garner, Ernest, 167
gas constant, 339
Gass, Saul, 140
Gayle, Frank, 300
Gibson, Kasson S., 25
Gibson-Tyndall curve, 25
Gifford, William, 107
Gilchrist, R., 97
Gilliland, T. R., 120
Gills, Thomas E., 227, 313
Ginnings, Defoe C., 7, 49
glass, 181
Goldberg, Karl, 135
Goldberg, Robert, 93
Goldfarb, Ron B., 294
Goldman, Alan, 140
Gordon, Fannie M., 77
Gornick, F., 104
Gould, Phillip, 331
graph theory, 140
Gray, Martha M., 172
Green, M. S., 149, 152
Greenspan, Martin, 69
Gross, Daniel, 28
Grossman, E. N., 90
Grover, Frederick W., 5, 16
guarded hot plate, 10
Guide to Available Software, 77
Guthrie, William, 132
Guttman, C. M., 104

H

Haar, Lester, 49
Hague, J. L., 97
Hahn, M. H., 10
Hall, John, 191
Hamer, Walter J., 43
Hamilton, Clark A., 315
Handwerker, Carol, 300
Hardis, Jonathan E., 25

Harper, D. R., III, 10
 Harris, Forest K., 230
 Hartman, Ike, 371
 Harvey, Allan H., 49
 Hasko, Steve, 132
 Haueter, Ruth C., 86
 Haynsworth, Emilie V., 135
 Hayward, Raymond W., 111
 HAZARD1 software, 347
 health care facilities, 275
 hearing, 53
 hearing aids, 174
 heat release in fires, 280
 heat transfer, 10
 heating and cooling systems, 266, 270
 Heckert, Alan, 132
 Heinrich, Kurt F. J., 160
 Heldenbrand, Jim L., 260
 Hembree, Gary, 371
 Henins, Albert, 194
 Hermach, Francis L., 90
 Hestenes, Magnus, 77, 81
 Heydemann, Peter, 230
 high pressure research, 100
 Hill, D. A., 120
 Hill, James E., 270
 Hillebrand, William Francis, 97
 Hilsenrath, Joseph, 49, 254
 Hinman, W. S., Jr., 59
 Hirshfeld, Alan, 209
 Hocken, Robert, 241, 322
 Hoffman, James Irvin, 97
 Hoffman, John, 104
 Holberton, Frances E. (Betty) Snyder, 258
 Holt, A. W., 86
 Hoppes, Dale D., 111
 Huang, D. X., 90
 Hudson, Ralph P., 111, 339
 Huggett, Clayton, 280
 Huntoon, Robert D., 59
 Hust, Jerry G., 294
 Hutchinson, J. M. R. (Robin), 209
 HVAC, 266, 270
 hydrocarbons properties, 93
 hydrogen isotopes, 43

I

icosahedral crystal symmetry, 300
 IGES, 246
 image processing, 86
 impedance, 5
 Inaba, Atsushi, 344
 inductance, 5
 Industrializing Economies, 230
 information security, 250
 infrared spectroscopy, 7, 100
 Ingberg, Simon, 28
 initial graphics exchange specification, 246
 Inn, Kenneth, 209
 inorganic analysis, 97

Insley, Herbert, 184
 Institute for Numerical Analysis, 77, 81
 insulation, thermal, 10
 Interamerican Metrology System, 230
 interferometry, 19, 194
 International Association for the Properties of Water and Steam, 49
 International Bureau of Weights and Measures, 1
 international cooperation, 230
 International Critical Tables, 1, 291
 International Temperature Scale of 1990, 339
 Internet sites, 1
 ion storage, 200
 ionosphere, 120
 ISO 9000, 366
 isotopes, 43
 Itano, W. M., 200

J

Jacobs, Madeleine, 174
 Jacobs, Robert, 107
 JANAF Tables, 93
 Jeffrey, Anne-Marie, 5, 56, 63, 315
 Jennings, Don, 178
 Jennings, Hamlin, 33
 Johnson, Stephen, 33
 Johnson, Victor, 107
 Jones, W. W., 347
 Josephson voltage standard, 315
 Journal of Physical and Chemical Reference Data, 291
 Journal of Research of NBS/NIST, 1
 Joy, David C., 328
 Judd, Deane B., 25, 174

K

Karen, Vicky Lynn, 188
 Kasen, M. B., 294
 Kashiwagi, Takashi, 344
 Kautz, Richard L., 315
 Kearsley, Elliot A., 126
 Kelly Committee, 59
 Kelly, George, E., 270
 Kemmerer, Sharon J., 246
 Kern, David, 319
 Khoury, Freddy, 104
 Kim, E. M., 297
 Kinard, Joseph R., 56, 63, 90, 315
 kinetics, 224
 King, David, 334
 Kirsch, Russell A., 86
 Klein, Ralph, 219, 224
 Knowles, H. B., 97
 Koch, J. A., 90
 Koenig, Joan, 368
 Kotter, F. R., 63
 Kropschot, Richard H., 107
 Kruger, Jerome, 174
 Ku, Harry, 129, 167, 209, 227
 Kusuda, Tamami (Tom), 260, 266
 Kuyatt, Chris E., 116, 129, 155, 203

L

laboratory accreditation, 167
Laidlaw, Frances, 359
Lanczos, Cornelius, 77, 81
Land, J. L., 368
Larrabee, Robert, 328
laser cooling, 200, 331, 375
laser excited desorption, 334
laser frequency measurements, 191
laser power and energy measurement, 178
Lashof, Theodore, 66
Launer, Herbert F., 66
Lauritzen, John, Jr., 104
Lawrence, James, 140
Lazar, John, 241
Leaderman, Herbert, 126
Ledbetter, Hassel, 294
Lehman, Shirley Young, 132
Leight, Walter G., 174
Leiner, A. L., 86
length standards, 19
Leonhardt, Rod, 178
Lett, Paul, 331
Lettieri, Tom, 371
Levelt Sengers, Johanna M. H., 49, 152
Levin, Ernest M., 184
Libes, Don, 353
Lide, Bettijoyce, 254
Lide, David R., 1, 93, 230, 231
Liepman, David S., 135
Liggett, Walter, 209
light properties, 25
light scattering, 149
Lindstrom, Richard M., 164
line shape, 116
linear systems of equations, 81
linewidth metrology, 328
Lipe, T. E., 90
Lippincott, Ellis, 100
Little, John L., 172
Liu, Y. M., 289
Livigni, David, 178
Lloyd, Francis L., 315
low-temperature materials, 294
Lozier, Daniel W., 135
Luecke, William, 174
Luke, Yudell, 135
luminous intensity, 25
Lundell, Gustav Ernst Fredrik, 97
Lyons, John W., 59

M

Madden, Robert, 116
Madey, Theodore, 219
Mahaffey, Charles T., 260
Malcomb Baldrige Quality Award, 357
Mandel, John, 66
Mandelkern, L., 104
Mann, Douglas, 107
Mann, Wilfrid Basil, 209

manufacturing, 322, 363
Manufacturing Extension Partnership, 363
maps, 66
Marienko, Ryna, 160
Marshall, Harold E., 260
Martin, Georgia, 73
Martin, William C., 73
Martys, Nicos, 33
Marx, Egon, 371
Mason, H. L., 230
mathematical functions, 135
mathematical tables, 77, 135
matrix eigenvalue problems, 77
Mattis, R. L., 289
Mayo-Wells, John F., 5, 56, 63, 90, 315, 319
McCamy, Calvin S., 145
McColskey, David, 350
McCoubrey, Arthur, 167
McHenry, Harry I., 294, 350
McMurdie, Howard, 100, 184
McNesby, James R., 224
McNish, A. G., 135
Mears, Thomas W., 227
Mease, Norman E., 46
measurement assurance, 129, 167, 209
measurement systems, 227
measuring machines, 241
Mehl, J. B., 339
Melmed, Al, 155, 219
MEP, 363
Merica, Paul D., 14
Messina, Carla G., 184
metallurgy, 350
meter, 191
metric system, 174, 234
metrology, 241
Michaelis, Robert E., 227
microanalysis, 160
microfilm preservation, 145
microphones, 53
microtopography, 214
microwave antennas, 319
microwave propagation, 120
Mielczarek, Stan, 203
Mighell, Alan D., 188
Miller, J. M., 16
minerals and rocks, 97
missiles, 59
Mohr, Peter J., 1
Moldover, Michael R., 339
Moore, Charlotte E., 73
Moulder, John C., 294
Mountain, Raymond D., 149, 152
Munro, Ronald, 184, 188, 300, 309
Musgrove, Arlene, 73
Myklebust, Robert, 160

N

Nagel, Roger, 246, 322
National Advisory Committee for Aeronautics, 46
National Applied Mathematical Laboratories, 135

National Conference on Weights and Measures, 368
National Defense Research Committee, 59
National Standard Reference Data System, 1, 230, 291
National Type Evaluation Program, 368
Narella, Mary Gibbons, 132
navigational aids, 38
NCSBCS, 260
near-field antenna measurements, 319
Nedzelniysky, Victor, 53
Nelson, Harold, 275
neutron diffraction, 303
Newbury, Dale E., 160
Newell, D. B., 56
Newman, M., 135
Nobel Prize, related to NBS/NIST work, 43, 111, 155, 214, 331
Novotny, D. B., 90
nuclear medicine, 209
Nyyssonen, Diana, 328

O

O'Brien, Anita, 363
O'Leary, Dianne P., 77, 81
O'Leary, M. J., 66
Oberhettinger, Fritz, 135
Office of Scientific Research and Development, 59
ohm, 63
Okabe, Hideo, 224
Oldham, Nile M., 56, 63, 315
Olsen, P. T., 56
Olver, F. W. J., 135
Omnidata, 254
Ondik, Helen M., 184
operations research, 140
optical density, 145
optical fibers, 297
optical interferometry, 194
optical modulation, 145
Ordnance Development Division, 59
Osbourne, Nathan S., 10, 49
Oser, Hans J., 38
oxygen consumption calorimetry, 280

P

Paffenbarger, George Colby, 309
Page, Chester, 59
Paige, L., 81
paper, 66
parity conservation, 111
Parker, Elizabeth, 258
Parker, William, 280
Parr, Albert, 7
Parsons, Douglas, 209
particle-sizing standards, 371
Passaglia, E., 1, 104
Peacock, R. D., 347
Peavy, B. A., 10
Peavy, S., 135
Peiser, H. Steffen, 43, 230
Peters, Chauncy, 19

Petersen, Russ, 191
Peterson, C. L., 63
Peterson, Stephen, 174, 260
phase equilibria diagrams, 184
Phillips, William, 200, 331, 375
photochemistry, 219, 224
photography, 145
photomask standards, 328
photometry, 7, 25
Pierce, Daniel T., 203
Piermarini, Gasper, 100
Pike, J. L., 86
Planck's constant, 7
plastics, 344
Plitt, Karl F., 174
Plumb, Harmon, 167
Plummer, E. Ward, 155
Polonsky, Ivan, 135
polymer crystallization, 104
polymers, 126, 344
polystyrene spheres, 371
Pontius, Paul, 129
Portland Cement Association Fellowship, 33
Postek, Michael T., 328
Potzick, James E., 46
Powell, Cedric J., 219
Powell, F. J., 10
Powell, Jeanne, 359
Powell, Robert, 107
precipitation hardening, 14
precision and accuracy, 129
pressure calibration, 100
Proctor, Thomas M., 69
protein crystallography, 303
Protein Data Bank, 1
proximity fuzes, 59
Purtscher, Patrick, 350

Q

quality award, 357
quality control, 313
quality standards, 366
quantum mechanics, 111
quasicrystals, 300

R

Rabinow, Jacob, 59
Radack, Shirley, 174
radiant energy, 25
radio, 16, 120
radio-beacons, 38
radioactivity standards, 209
radiochemistry, 164
radiometry, 7
radionuclides, 209
radiopharmaceuticals, 209
Rasberry, Stanley, 160, 167
Read, Dave T., 294, 350
Reader, Joseph, 73
reduced cells, 188

Reed, Richard P., 294
Reed, William P., 227
Reeve, Charles, 241
reflectance, 145
refrigeration, 10
Reilly, M. L., 7
Reinstsema, C. D., 90
Repjar, A. G., 319
resistance standards, 63
resistivity in silicon, 289
rheology, 126
Richter, Lee, 334
Richter, Ralph A., 234
Ripple, Dean, 339
Robbins, Carl R., 184
Robinson, Henry, 10
robotics, 237
Rolston, Steven, 331
Rosa, Edward B., 1, 5
Ross, G. S., 104
Rosser, J. Barkley, 77, 81
Rossini, Frederick D., 93
Roth, Robert S., 184
Ruegg, Rosalie, 359
Rumble, John R., Jr., 93, 230, 254, 291

S

Sanchez, I. C., 104
Santoro, Antonio, 188
scaling theory, 152
scanning probe microscopy, 214
scanning tunneling microscope, 155
Schafft, Harry A., 123
Scheer, M. D., 219
Schenck, Peter K., 184
Schiller, Susannah, B., 313
Schmidt, Leonard, 178
Schooley, James, 1
Schoonover, Irl, 100
Schubauer, Galen, 46
Scire, Fredric, 214
Scott, H., 14
Scott, Russell B., 107
Scott, Thomas R., 178
Scribner, B.F., 97
SEAC, 86, 172
second breakdown, 123
security alarms, 174
semiconductor device metrology, 328
semiconductors, 289
SEMPA, 203
Sengers, Johanna, 49, 152
Severo, Norman C., 132, 135
Seward, Richard W., 227
Shaw, Merle B., 66
Shives, T. Robert, 350
Shupe, P. D., 86
SI (International System of Units), 1, 5, 25, 56, 63, 90, 191, 194, 234, 315
Sienkiewicz, Robert, 359
Siewert, Tom, 350
silicon, 289

Simiu, E., 283
Simpson, John A., 116, 155, 167, 203, 241, 322
Sjölin, Lennart, 303
Skramstad, Harold K., 46
Slutz, R. J., 86
Small, John, 160
Smid, Miles, 250
Smith, Bradford, 322
Smith, J. L., 86
smoke detectors, 174
Smyth, Deborah, 357
Snyder, Kenneth, 33
Snyder, W. F., 120
software testing, 258, 353
Somerville, Paul, 132
sound pressure, 53
sound waves, 69
Southard, Thomas H., 135
Southworth, G. C., 16
space beads, 371
Sparks, Larry L., 294
spectroscopy, 7, 73, 116, 155, 194, 200, 331, 375
speed of light, 191
spin-polarized electrons, 203
Spivack, Richard N., 359
standard reference data, 49, 73, 93, 184, 230, 254, 291
standard reference materials, 209, 227, 230, 313, 371
Stanley, Connie, 227
Statistical Engineering Laboratory, 129, 132
statistics, 129, 132, 164, 167
steam tables, 49
Steckler, Kenneth D., 280
Steel, Eric, 160
Stefan-Boltzmann constant, 7, 339
Stein, Phil, 167
Stein, Steve, 254
Steiner, Bruce, 25
Steiner, Richard L., 56, 315
Stephenson, John, 334
Stigler, Stephen, 129
Stimson, Harold F., 49
Stratton, Samuel Wesley, 5, 7
stress relaxation, 126
Stroup, David, 275
structural design, 283
Sugar, Jack, 73
Sullivan, Donald B., 191, 200
superconductors, 306
supercritical fluids, 152
surface science, 155, 214, 219, 334
synchrotron radiation, 116

T

Tang, Yi-hua, 56, 63, 315
Taylor, Barry, 1, 129
Taylor, James, 22
Taylor, John Keenan, 97, 313
Teague, E. C., 214
Technical Association of the Pulp and Paper Industry, 66
technology development, 359
Tesk, John A., 309
thermal conductivity, 10
thermal converters, 90

thermal insulation, 10
thermodynamics, 49, 93, 152
Thomas, James L., 63
Thompson, George N., 22
three-dimensional metrology, 241
Thurber, W. Robert, 289
Tilley, W. Reeves, 174
time-dependent materials, 126
tires, 174
Tobler, R. L., 294
topografiner, 214
traceability, 167, 209
Trahey, Nancy M., 313
transistors, 123
Trusler, J. P. Martin, 339
Tschiegg, Carl, 69
turbulence, 46
Tyndall, Edward P. T., 25

U

Ugiansky, Gil M., 368
uncertainty, 129
Unertl, Bill, 203
Univac, 86
universal gas constant, 339
Universal Product Code, 174

V

Van Dusen, Milton, 10
Van Valkenburg, Alvin, 100
Vanderah, Terrell A., 184
velocity of light, 191
Vicentini-Missoni, M., 152
Vieth, Donald, 160
Villarrubia, J. S., 214
viscoelasticity, 126
visibility of radiant energy, 25
volt and voltage measurement, 90, 315

W

Wachtman, John B., 100
Wagman, Donald, 93
Wagner, Leon, 107
Wait, James R., 120
Walls, F. L., 200
Waltenberg, R. G., 14
Walton, George, 260, 266
Wang, Andrew, 359
Wang, Gwo-Ching, 203
war work at NBS, 1, 46, 59, 66
Ward, John, 214
Washburn, E. W., 1, 291

Watts, Richard, 331
wavelength standards, 194
Web Book (Chemistry), 93
Weber, Charles G., 66
Weeks, J. J., 104
weights and measures, 368
Weinberger, A., 86
Weir, Charles E., 100
Wells, Joe, 191
West, Dale, 178
Westbrook, Christoph, 331
Westbrook, Jack, 254
White, Howard J., 49
Wichers, E., 97
Wiederhorn, Sheldon, 181
Wieman, Carl, 375
Wiese, Wolfgang L., 73
Williams, Edwin R., 56, 63, 315
Wilson, William K., 66, 174
Wineland, David J., 200, 375
Witt, R. P., 86
Witzgall, Christoph, 140
Wlodawer, Alexander, 303
Wood, L. A., 104
Wooley, H. W., 107
World Wide Web sites, 1
Wright, J. H., 86
Wright, James R., 260
Wright, Richard, 28

X

x-ray diffraction, 188, 303
x-ray wavelength measurements, 194

Y

Yates, John, 219, 334
Yokley, C. R., 7
Yolken, H. Thomas, 227
Youden, W. J., 33, 129, 209
Young, M., 297
Young, Russell D., 155, 214, 219

Z

Zalubas, Romuald, 73
Zapas, Louis J., 126
Zarr, Robert, 10
Zelen, Marvin, 135
Zimmerman, Brian, 209
Zingesser, Joel P., 22
Zucker, Ruth, 135