

Armored force field manual : the tank company, light and medium.

United States.

Washington, D.C. : U.S. Govt. Print. Off., 1942.

<https://hdl.handle.net/2027/uc1.a0009351198>

HathiTrust



www.hathitrust.org

Public Domain, Google-digitized

http://www.hathitrust.org/access_use#pd-google

We have determined this work to be in the public domain, meaning that it is not subject to copyright. Users are free to copy, use, and redistribute the work in part or in whole. It is possible that current copyright holders, heirs or the estate of the authors of individual portions of the work, such as illustrations or photographs, assert copyrights over these portions. Depending on the nature of subsequent use that is made, additional rights may need to be obtained independently of anything we can address. The digital images and OCR of this work were produced by Google, Inc. (indicated by a watermark on each page in the PageTurner). Google requests that the images and OCR not be re-hosted, redistributed or used commercially. The images are provided for educational, scholarly, non-commercial purposes.

Doc 17-32

FM 17-32 ✓

A
 0
 0
 0
 9
 3
 5
 1
 1
 9
 8

UC SOUTHERN REGIONAL LIBRARY FACILITY



WAR DEPARTMENT

**ARMORED FORCE
FIELD MANUAL**



**THE TANK COMPANY,
LIGHT AND MEDIUM**

August 2, 1942

UNIVERSITY OF CALIFORNIA
AT LOS ANGELES

SEP 23 1942

LIBRARY

of Californ
Regional
Facility

Generated at Library of Congress on 2022-12-15 16:10 GMT / https://hdl.handle.net/2027/uc1_a0009351198
Public Domain, Google-digitized / http://www.hathitrust.org/access_use#pd-google

FM 17-32

**ARMORED FORCE FIELD
MANUAL**



**THE TANK COMPANY,
LIGHT AND MEDIUM**



**UNITED STATES
GOVERNMENT PRINTING OFFICE
WASHINGTON : 1942**

Generated at Library of Congress on 2022-12-15 16:10 GMT / <https://hdl.handle.net/2027/uc1.a0009351198>
Public Domain, Google-digitized / http://www.hathitrust.org/access_use#pd-google

**WAR DEPARTMENT,
WASHINGTON, August 2, 1942.**

FM 17-32, Armored Force Field Manual, The Tank Company, Light and Medium, is published for the information and guidance of all concerned.

[A. G. 062.11 (6-28-42).]

BY ORDER OF THE SECRETARY OF WAR:

G. C. MARSHALL,
Chief of Staff.

OFFICIAL:

J. A. ULIO,
Major General,
The Adjutant General.

DISTRIBUTION:

**D 2, 7 (5); B 6 (5); IR 2, 7 (5); Bn and H 17, 18 (10);
I Bn 2, 5-10 (3); C 17 (20); IC 2, 5-7, 11 (5).
(For explanation of symbols see FM 21-6.)**

TABLE OF CONTENTS

	Paragraphs	Page
SECTION I. General -----	1-8	1
II. Training -----	9-10	11
III. Control, orders, liaison, reconnaissance, maintenance -----	11-15	13
IV. Security -----	16-21	21
V. Marches -----	22-23	34
VI. Offensive action -----	24-37	35
VII. Defense -----	38-42	75
VIII. Jungle warfare -----	43-45	77
APPENDIX. Troop leading -----		78
INDEX -----		85

ARMORED FORCE FIELD MANUAL













THE TANK COMPANY, LIGHT AND MEDIUM

SECTION I

GENERAL

■ 1. SCOPE.—a. This manual covers the tactics and technique of the light and the medium tank company, and is applicable to the tank companies of both armored regiments and separate tank battalions. It supplements pertinent matter contained in FM 17-10. It covers the action of the company when acting as part of the battalion and when acting alone. The company will habitually be reinforced whether acting alone or as part of the armored battalion.

b. Key to illustrations:

	ASSAULT GUN
	AMMUNITION CARRIER
	MORTAR CARRIER
	INFANTRY PERSONNEL CARRIER
	TANK IN MOTION
	TANK IN POSITION
	1/4 TON TRUCK
	MOTORCYCLE
	EXPLOSIVE SHELL FIRE
	SMOKE SHELL FIRE
SYMBOLS TO INDICATE CERTAIN VEHICLES	
	COMPANY COMMANDER'S VEHICLE (HT OR TANK)
	SECOND-IN-COMMAND'S VEHICLE (HT OR TANK)
	PLATOON LEADER'S TANK

■ 2. PURPOSE.—This manual is only a guide to the employment of the tank company. The formations and actions described herein are not inflexible. Each tactical situation must be solved on its own merits and not by blind application of a set of inflexible rules. Initiative of all commanders must be encouraged.

■ 3. PRIOR TRAINING.—Individual crew, section, and platoon training should be completed before proceeding to company training. The technique of operation of vehicles and weapons and of the employment of the various weapons should have been covered in earlier instructions. (See sec. II.)

■ 4. ORGANIZATION.—*a.* The tank company, both light and medium, consists of a company headquarters and three tank platoons of five tanks each.

b. Company headquarters.—(1) Company headquarters is composed of a—

- (a) Command section.
- (b) Tank section.
- (c) Communication-liaison-reconnaissance section.
- (d) Maintenance section.
- (e) Administrative and supply section.
- (f) Mess section.

(2) On the march when combat is imminent and when the company is in combat the administrative and supply section and the mess section are with the battalion or higher unit trains.

(3) The command section consists of the company commander and various individuals mounted in a half-track vehicle. During combat the company commander rides in one of the tanks of company headquarters. The command section half-track joins the maintenance officer.

(4) One tank of the tank section is used by the company commander. The other tank is used by the maintenance officer who is also second-in-command of the company. This tank is used as a replacement for the company commander's or a platoon leader's tank.

(5) The communication-liaison-reconnaissance section is equipped with a $\frac{1}{4}$ -ton truck. It is used on the march for

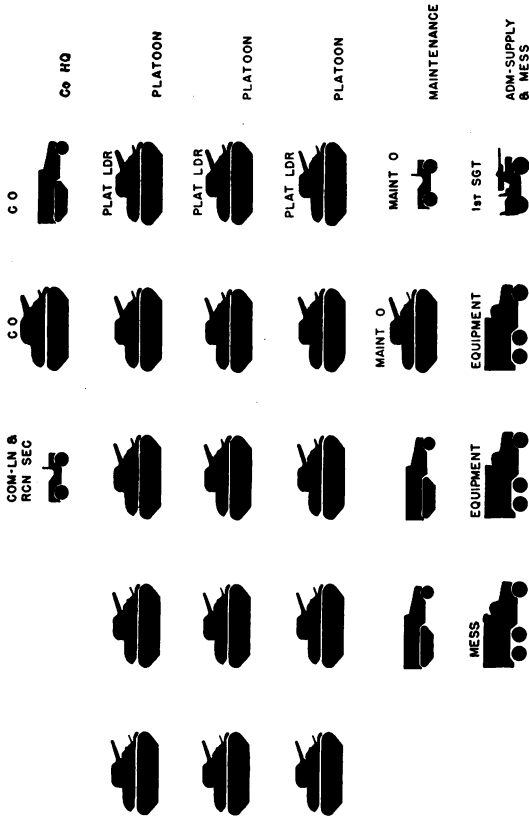

NORMAL ATTACHMENTS SAME AS LIGHT TANK COMPANY
 MAY BE ATTACHED SAME AS LIGHT TANK COMPANY

FIGURE 2.—Medium tank company.

NORMAL ATTACHMENTS

472732°—42—2



MAY BE ATTACHED



FIGURE 3.—Attachments, tank company, light and medium.

5

reconnaissance short distances to the sides and for liaison with higher headquarters, especially when the company is attached to another unit such as an infantry battalion. When not used for liaison this section remains with the maintenance officer and proceeds with him to the company rallying point. Here the staff sergeant in charge makes such repairs and adjustments on radio sets as time and means permit.

(6) The maintenance section is organized and equipped to perform second echelon maintenance for the company. It is equipped with a $\frac{1}{4}$ -ton truck and two half-track vehicles. During the march it follows at the tail of the company and makes such repairs to vehicles as it can. Vehicles beyond the capabilities of the section to repair are left with their crews, for regimental or maintenance battalion personnel. During combat the section accompanies the company to the attack position where it assists in making last minute repairs. It follows the attack as closely as practicable, along an axis of maintenance prescribed by the company commander, to repair tanks that are out of action.

(7) The maintenance officer, second-in-command of the company, commands the maintenance section and supervises all maintenance in the company. He accompanies the company to the attack position. After the attack starts he assumes charge of all vehicles left at the attack position, that is, the maintenance vehicles, the second company headquarters tank, and the communication-liaison-reconnaissance $\frac{1}{4}$ -ton truck. He moves these vehicles forward, following the company as closely as practicable, makes repairs on damaged tanks, makes estimates of material needed to repair those beyond the capabilities of his section to repair, transmits this information with the exact locations of the disabled vehicles to the regimental maintenance platoon, and rejoins the company at the rallying point.

■ 5. CHARACTERISTICS.—*a.* The tank is characterized by great mobility, fire power, armor protection, and shock action. These characteristics are possessed in varying degrees by different types of tanks. The characteristics dictate the manner of employment.

b. Light tanks, as compared to medium tanks, have less fire power, lighter armor, and greater speed and maneuverability. They are particularly fitted for—

(1) Feeling out the enemy and developing the weak spots in the enemy position through which medium tanks may attack.

(2) Screening the advance against light enemy resistance.

(3) Leading an attack against an unarmored enemy weak in antitank defense, when speed is essential.

(4) A fast maneuvering force to exploit the success of medium tanks.

(5) Maneuver to the flank or rear to strike the enemy command posts, communication centers, and other vital installations.

(6) Pursuing a defeated enemy.

c. Medium tanks, because of their greater fire power, guns of heavier caliber, greater armor protection, and shocking power are used to—

(1) Lead an attack against an enemy whose position and strength is known.

(2) Support by fire the attack of either light or other medium tanks.

■ 6. OPERATION.—a. The tank company is normally employed as part of the tank battalion. It may, however, be used as advance, flank, and rear guard and on separate missions.

b. The reinforcement of the tank company will be normal. Such reinforcements will vary from a mortar and an assault gun from the battalion headquarters company to one or more infantry platoons, engineers, artillery, and reconnaissance elements. A light tank company may have a medium tank platoon attached to or supporting it for certain operations.

■ 7. FUNDAMENTALS.—a. *Surprise.*—Surprise is obtained by striking the enemy at an unexpected time, from an unexpected direction, and in sufficient numbers to gain the objective. Speed of movement and the use of covered approaches assist in gaining surprise. *Seek to surprise your enemy but do not let yourself be surprised. Give your enemy credit for as much tactical knowledge as you have or more. Do not*

underestimate him. Expect the unexpected and be prepared for it.

b. Fire and maneuver.—The company advances by fire and movement. A portion of the command maneuvers against the enemy while the remainder covers that movement. This covering force does not necessarily fire all the time while the other force is maneuvering. It takes up positions where it can bring effective fire on any enemy holding up the advance. It fires only when necessary to assist the advance. After the maneuvering force has advanced beyond supporting distance of the covering force, it may take positions and become the covering force while the former covering force becomes the maneuvering force.

c. Mass.—Concentrate your fire power and shock action on the enemy. Do not fritter away your strength on small, unimportant targets. Concentrate on an objective that is decisive; the others will then fall.

d. Conservation of ammunition.—The tank carries a relatively small amount of ammunition and resupply is difficult. It is imperative that each round be made effective. Do not fire with the 75-mm and 37-mm guns until there is something at which to shoot. (See sec. II.)

■ **8. TERRAIN.**—*a.* The tank is sensitive to terrain. For most efficient use, tanks should operate over terrain that will permit advance by covered routes at good speed.

b. The tank company commander must continually study terrain and seek to turn it to his advantage.

c. The following types should be avoided:

- (1) Ground covered with large stumps.
- (2) Heavy woods.
- (3) Swamps.
- (4) Ground covered with large boulders.
- (5) Steep slopes.

d. Just because ground appears impassable for tanks does not justify dismissal of possibility of attack either by yourself or the enemy over such ground. Only by detailed reconnaissance can passableness be determined. In many cases passage of difficult ground is justified by surprise effect gained.

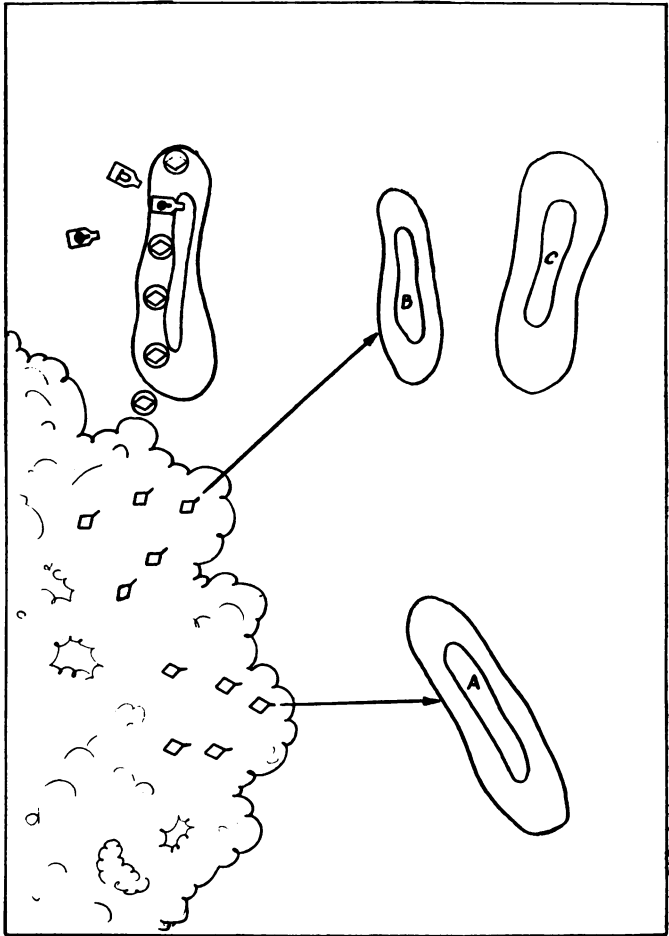

FIGURE 4.—Fire and maneuver. One platoon from defiladed stationary positions, together with mortar and assault gun, supports advance of other platoons.

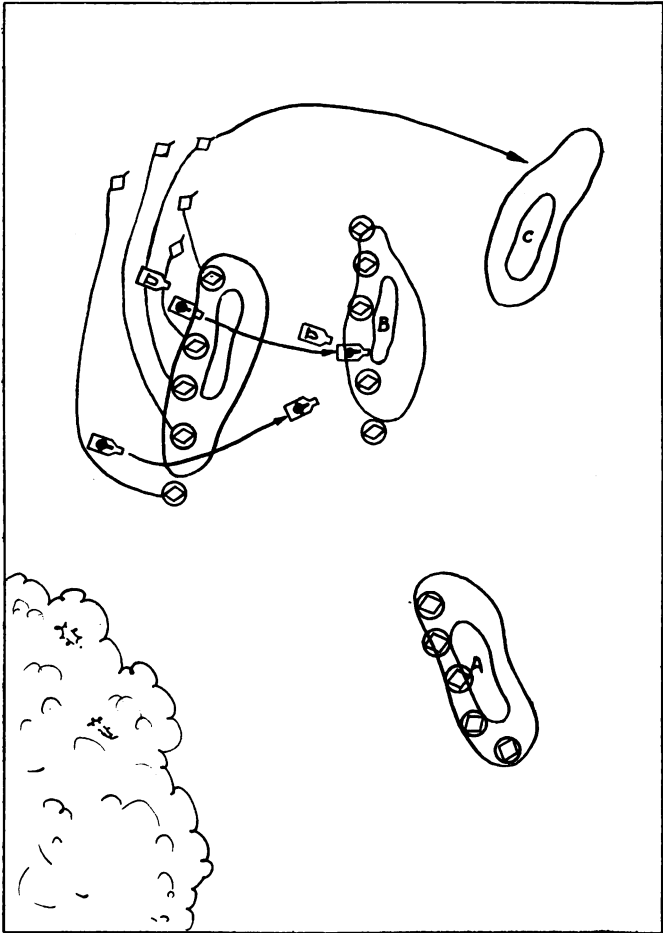

FIGURE 5.—Fire and maneuver. After platoon has reached B it takes up firing positions to cover advance of other platoons. Mortar and assault gun displace forward.

SECTION II

TRAINING

■ **9. GENERAL.—a.** Training of the tank company must be progressive. It is divided roughly into phases as follows:

- (1) Basic.
- (2) Specialist.
- (3) Marksmanship.
- (4) Technique of fire.
- (5) Section and platoon combat exercises without ammunition.
- (6) Combat practice firing.
- (7) Company combat problems.

b. Each phase should be completed before proceeding to the next. The efficiency of the company as a whole will depend upon the thoroughness with which each individual unit is trained.

c. Throughout the training period emphasis must be placed upon cooperation, coordination, and individual initiative. Training methods are covered in general in FM 21-5.

d. Each exercise scheduled for company training must include training in ammunition conservation. Although exercises are conducted without ammunition this subject must always be kept in mind. During exercises the 37-mm and 75-mm gunners should be required to simulate firing and assistant gunners should keep track of the number of rounds the gunner has simulated firing. When all ammunition is fired the gunner ceases firing. In this manner, and this only, can troops be trained in the proper conservation of ammunition. If promiscuous simulated firing without thought of ammunition supply is permitted, wasteful habits will be developed. The tank commander requires frequent reports from gunners concerning ammunition supply. The chart below shows in a startling manner what a comparatively small amount of ammunition is available.

Weapons	Rounds carried	Usable rate of fire per minute per weapon	Firing at usable rate ammunition will last (minutes)	Number of targets that can be engaged with ammunition available at 5 rounds per target
Light tank M3:				
5 caliber .30 MG	6,000	125	10	-----
1 37-mm gun	103	10	10	21
Medium tank M3:				
4 caliber .30 MG	8,000	125	16	-----
1 37-mm gun	150	10	15	30
1 75-mm gun	50	6	8	10
Medium tank M4:				
3 caliber .30 MG	8,000	250	12	-----
1 caliber .50 MG	300	125	2.5	-----
1 75-mm gun	75	6	12.5	15

e. Tactical training of the company should be in the following sequence:

- (1) Security.
- (2) Marches.
- (3) Offense.
- (4) Defense.
- (5) Special operations.

■ 10. TRAINING PROCEDURE.—a. Instructive training is possible only when interest is maintained. To prepare interesting instruction requires much detailed work on the part of the company commander and his assistants. Careful planning is essential to smooth execution. The preparation for a tactical problem cannot be left to the day before the problem is to be played. The company commander must plan his problems well in advance and must use his company officers and senior noncommissioned officers to assist him. (See FM 21-5 and TF 7-295.)

b. (1) First plan a series of problems to bring out the different phases of combat listed in paragraph 9. For each problem select by map study a suitable piece of terrain to bring out the lessons desired. With the company officers

walk and ride over this terrain so as to be absolutely familiar with it.

(2) Stake out the problem on the map. With the company officers, or other company commanders, war game the problem and iron out any rough points and unsound tactical procedures.

(3) By using a sand table and blocks of wood to represent vehicles, play the problem. During this phase, selected non-commissioned officers are present. The problem may be played several times, each officer or noncommissioned officer being called upon for a solution to a particular phase. (TF 7-265 and 7-266.) Interest is maintained by injecting a variety of small situations.

(4) The problem is next played on the ground. A critique is held and errors pointed out. The whole or portions of the problem may be run several times. It should be run a sufficient number of times for each platoon to engage in each phase of action.

c. Company officers are used to assist in the preparation of exercises and each may be given a particular exercise to prepare and supervise. Each officer must be trained not only to command his own platoon but the company as well.

SECTION III

CONTROL, ORDERS, LIAISON, RECONNAISSANCE, MAINTENANCE

■ 11. CONTROL.—a. Control is exercised by—

(1) Giving specific orders as to routes, directions, boundaries, objectives, and rallying points.

(2) Use of radio.

(3) Use of signals.

b. Once an attack has started and combat is entered, control becomes increasingly difficult. Units become disorganized, leaders become casualties, direction may be lost, the enemy may force some units away from their assigned missions. Only by giving definite orders for the initial attack and by seeing that each individual tank crew knows and understands these orders can a company commander assure himself of control of the unit. Orders are covered in paragraph 12.

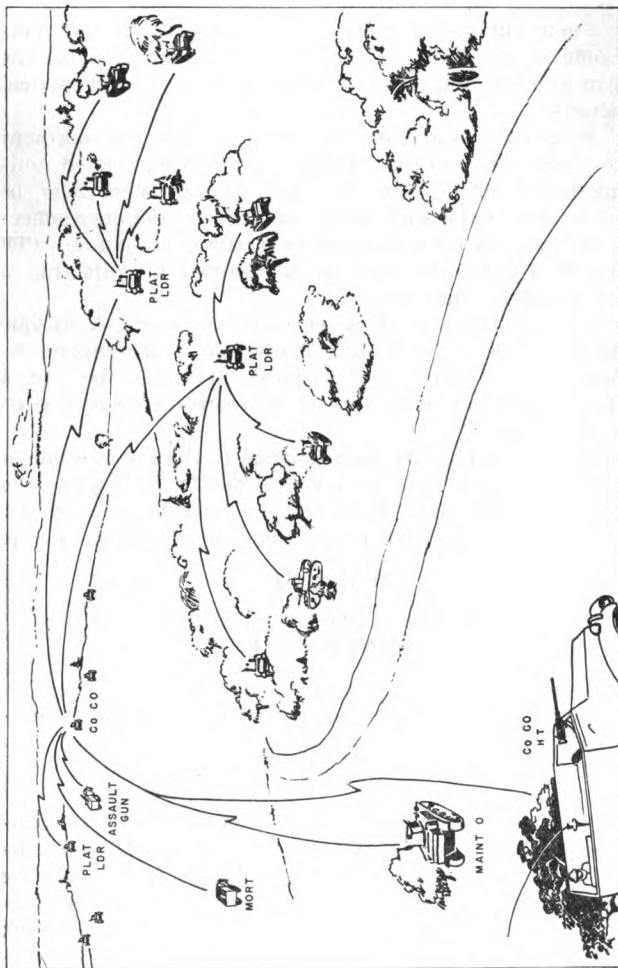

FIGURE 6.—Radio net, tank company.

Generated at Library of Congress on 2022-12-15 16:10 GMT / https://hdl.handle.net/2027/uc1.a0009351198
Public Domain, Google-digitized / http://www.hathitrust.org/access_use#pd-google

c. (1) The company commander's tank is equipped with an SCR-508 set. The maintenance officer's tank and each platoon leader's tank are equipped with an SCR-528 set. Each other tank in the platoons has an SCR-538 set, which is a receiver only. The company commander's half-track has an SCR-510 set. The company commander keeps one receiver tuned on the company net and the other on the net of the next higher unit. Voice only is used in transmitting.

(2) Radio procedure is simple. Officers use the radio themselves. As there will be only one frequency for the company, strict radio discipline must be maintained. Only short, concise messages are sent, as long messages may not only be confusing but will deny the use of the radio to others.

d. Flag signals as prescribed in FM 17-5 or improvised signals may be used. Such signals are more appropriate for a platoon as distances will make recognition of signals given by the company commander extremely difficult.

■ 12. ORDERS.—a. Orders of the tank company commander are oral and when practicable are given from a point at which as much as possible of the terrain to be traversed can be seen. Available maps, aerial photographs, or sketches are used to supplement personal observation.

b. The order follows the form given in FM 101-5. It should be clear and brief. The mission of the company and each platoon must be stated so that it will be unmistakable.

c. During the combat training period, special attention must be paid to the subject of combat orders. During the map and sand table exercises, each individual who may be required to give orders must be practiced in delivery of combat orders. *Each individual must strive to make himself perfect in the delivery of such orders so that under the stress of combat he will be able to make himself clearly understood.*

d. In the problem depicted in figure 7, Company A, right assault company of the battalion, has been ordered to attack due north astride the north-south road. Battalion objective is a village 4 miles to the north. A church spire in the village can be seen from A. The company commander is at A. He has his platoon leaders, the infantry platoon leader, leader of the supporting medium tank platoon, the mortar squad leader, and the assault gun section leader with him. (This

may be either a light or medium tank company.) The company commander gives the following order:

The enemy has small infantry forces with a few antitank guns on that hill (hill D) and in that woods (woods B). Our reconnaissance elements are along that stream to our front. They report the stream passable at all points.

There are no troops on our right.

The battalion attacks at 10:00 AM with Companies A and B in assault, Company A on the right, to seize high ground south of village ----- You can see the church spire in the village. It's about 4 miles away.

Artillery will fire a 5-minute preparation on that hill.

Dive bombers will attack that hill (hill D) at 10:00 AM.

We attack at 10:00 AM first and second platoons in assault, second platoon on right, and will seize north portion of the battalion objective.

Direction of attack, due north, astride that road.

First platoon attack from woods to our right rear, overrun that hill (hill D), and continue on to the objective.

Second platoon attack from woods to east (woods C), overrun those woods (woods B), and continue to objective. Protect right flank.

Third platoon follow second platoon. Support second platoon initially from edge of those woods (woods C). Thereafter advance and continue support of the second platoon. Be prepared to repel counterattacks from east.

Support platoon, from positions on this hill, support first platoon. Move forward to that hill (hill D) after infantry reaches the hill, support the infantry.

Infantry platoon follow first platoon at 500 yards in carriers.

Assault gun, position this hill, support attack by fire on located AT guns. Move forward with support platoon.

Mortar, position in woods in rear of this hill. Smoke woods near road on east slope of that hill (hill D) at 9:55 AM, five rounds. Then shift to woods on west slope, five rounds. Move forward with support platoons.

Rallying point, ravine this side of battalion objective.

Alternate rallying point present position.

Axis of maintenance that north-south road.

Battalion axis of maintenance, same road.

Aid station will be established at rallying point.

Battalion medical detachment advances along that north-south road.

I will be on this hill until first platoon reaches that hill (hill D). Thereafter I will follow first platoon.

Radio silence lifts at 9:55 AM.

Are there any questions?

It is now -----

e. An order given by use of the map is similar to the above, except that objectives, routes, and enemy positions are pointed out on the map.

f. An aerial photograph may be used instead of the map. Oblique photographs are especially good for such orders.

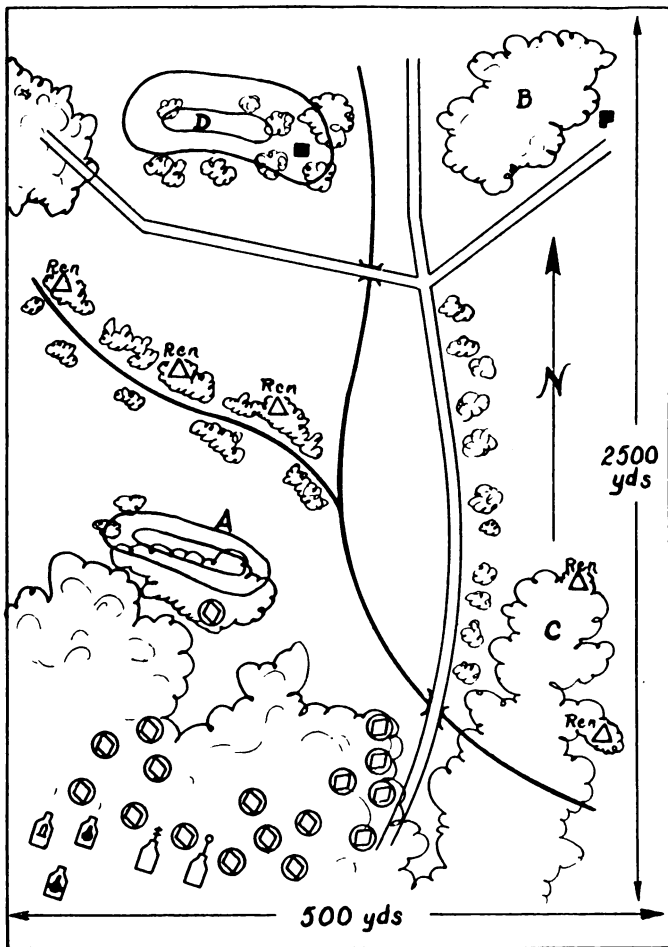

FIGURE 7.—Attack order.

■ 13. **LIAISON.**—The company commander maintains liaison with battalion headquarters by means of radio and communication-liaison-reconnaissance section. This section goes to the battalion CP as soon as the company reaches its attack position. It returns to the company at the rallying point or when sent back by the battalion commander.

■ 14. **RECONNAISSANCE.**—*a.* The company has only the communication-liaison-reconnaissance section mounted in a $\frac{1}{4}$ -ton truck as reconnaissance personnel. Much of the detailed reconnaissance for employment must necessarily be made by the company commander, platoon leaders, and tank crews. The battalion reconnaissance platoon may be attached at times.

b. The company commander obtains all possible information from battalion headquarters. Next he moves with his platoon leaders to the attack position, reconnoiters the ground, and there contacts regimental and higher unit reconnaissance personnel. He then gives his order from a position which affords the best possible view of the terrain over which the attack will be launched.

c. The platoon leader makes as thorough a reconnaissance as time permits. When practicable he takes his tank commanders over the route to the line of departure and points out the enemy position and routes of advance.

d. Very little reconnaissance can be made in a tank. The presence of tanks on reconnaissance may cause loss of surprise. Platoon and section leaders may go forward in the company commander's half-track. Much of the reconnaissance must be made on foot.

■ 15. **MAINTENANCE.**—*a.* The tank company has a maintenance section equipped with a $\frac{1}{4}$ -ton truck and two half-tracks M3. The maintenance officer is in charge of this section. He has with him the second company headquarters tank when that tank is not used as a replacement.

b. The maintenance vehicles are equipped with caliber .30 machine guns for local protection.

c. (1) During the attack the maintenance section follows the company as closely as conditions permit and assists in repairing disabled tanks and in extricating tanks that have



FIGURE 8.—Do not attempt to repair vehicle in the open when it can be towed to cover.



FIGURE 9.—Tow vehicle to cover.

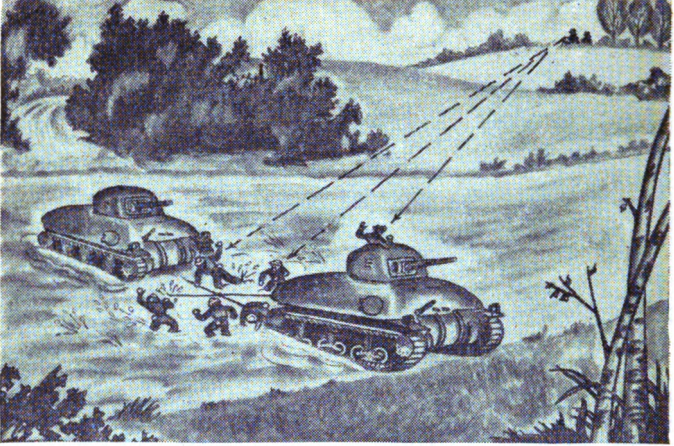

FIGURE 10.—Do not attempt to place tow cable on disabled vehicle without first providing fire protection for dismantled men.



FIGURE 11.—Cover dismantled men by fire.

become mired or are otherwise unable to proceed. The company commander should designate an axis of maintenance. All tank crews should know this axis so that a member of the crew may be sent to contact the maintenance section as it moves forward.

(2) The maintenance section should expect to meet resistance from isolated groups of enemy passed over by the company. It may have to fight its way through and it may have to repair or extricate vehicles under fire. It uses the fire power of its vehicular weapons and the tank to cover the men working on the disabled vehicle.

(3) The maintenance section will estimate the extent of the damage to any tank which is disabled beyond the capability of the section to repair, and will transmit this information, with the location of the disabled vehicle, to the regimental maintenance platoon.

SECTION IV

SECURITY

■ 16. GENERAL.—*a.* Security in general of armored units is covered in FM 17-10. Each unit from the highest to the lowest is responsible for its own security. A commander must always take adequate measures to prevent being surprised. This must be the case whether in bivouac, on the march, in the attack, or in a rallying position.

b. The senior commander is responsible for general security but this in no way relieves subordinate commanders of the responsibility for local security.

■ 17. SECURITY IN BIVOUAC.—*a.* The company secures itself in bivouac by dispersing its vehicles and by placing tanks so that their weapons will cover avenues of approach and posts dismounted men armed with submachine guns at points of observation. (See FM 17-10.) If infantry is available, it is usually used for this purpose. Otherwise members of tank crews must be used.

b. Security must be adequate, but it must be so organized that men get the maximum rest.

c. Each platoon and the company must always have one man awake at the CP to give an alarm. Tank crews must be

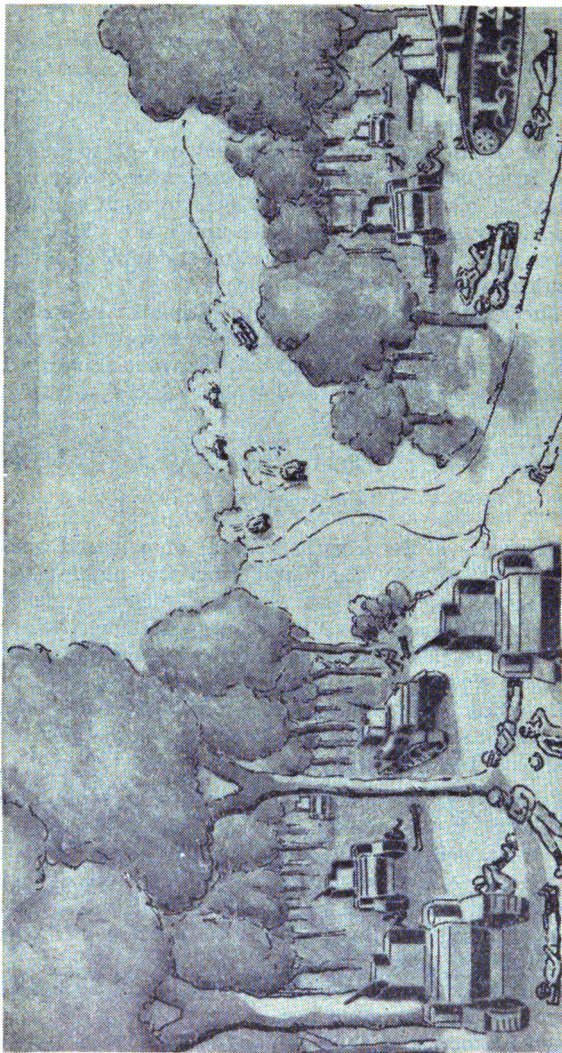

FIGURE 12.—All men should not go to sleep.

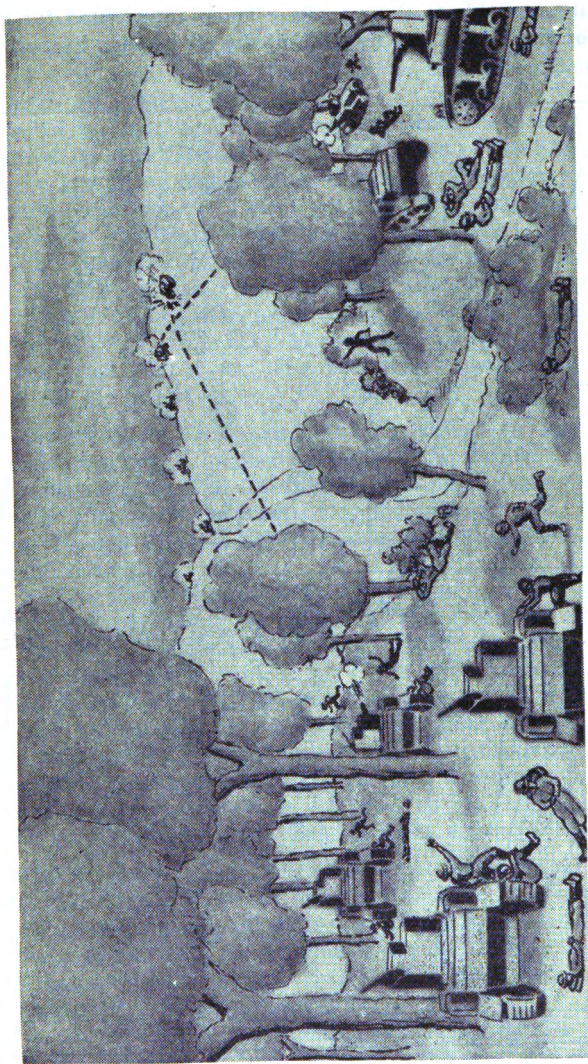

FIGURE 13.—One man must be awake to give alarm. Some vehicles must be sited to cover approaches.

readily available to their tanks. Those tanks sited for protection must have one member of the crew ready to man the guns.

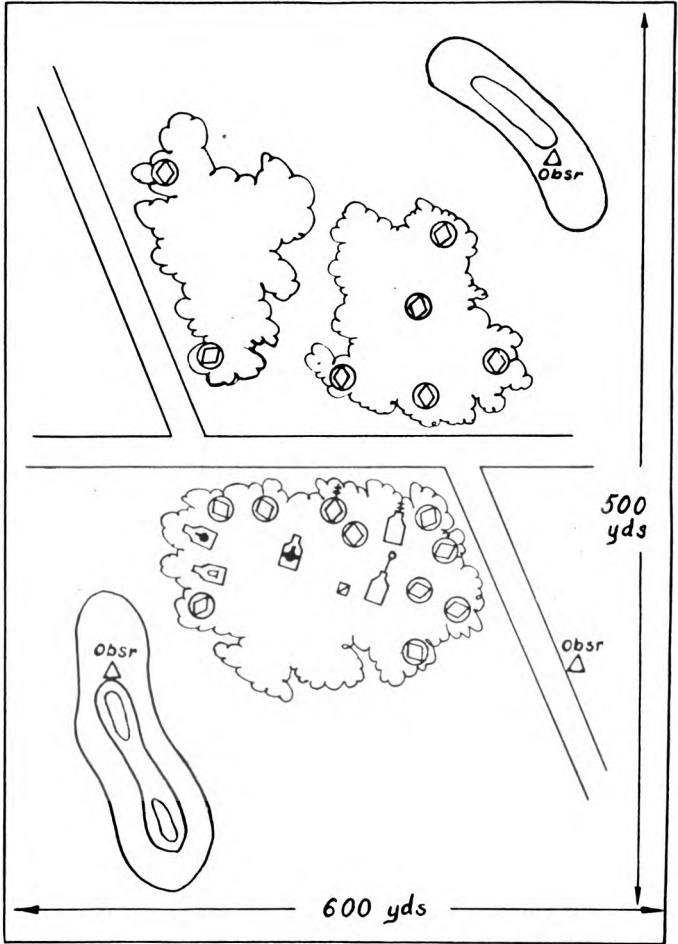

FIGURE 14.—Security in bivouac. Cover all avenues of approach.

Generated at Library of Congress on 2022-12-15 16:10 GMT / https://hdl.handle.net/2027/uc1_a0009351198
Public Domain, Google-digitized / http://www.hathitrust.org/access_use#pd-google

d. In bivouac and at long halts in assembly areas, slit trenches must be dug for personnel not in tanks. In bivouac, even tank crews dig slit trenches to protect themselves from sudden air attack. (FM 21-45.)

e. In bivouac, security from air attack is primarily obtained by concealment. (See FM 17-10.) Do not fire at single low-flying planes unless attacked. The enemy may be trying to get you to disclose your position. Air sentries are posted to give instant warning of approaching hostile aircraft. At the approach of aircraft take cover. If caught in the open, do not run. Lie down and remain motionless. At a halt of more than a few minutes, all troops except tank crews dig slit trenches. For ranges at which to fire at planes, see FM 17-62. For protective measures for individuals, see FM 21-45.

■ 18. ASSEMBLY AREAS AND RALLYING POINTS.—a. Security in assembly areas is similar to security in bivouac. Platoons are disposed to give all-around protection. Observers are posted to give timely warning of enemy approach. Vehicles are disposed to cover likely avenues of approach. Concealment is sought.

b. The first consideration at rallying points is security. The most opportune time for the enemy to attack is while a unit is reorganizing. Therefore, the first unit to arrive immediately posts vehicles to cover likely avenues of approach and observers to warn of any approach. As additional units arrive the company commander posts additional security details. Again concealment must be sought. The extent of security posted depends upon the proximity of the enemy and the protection afforded by other troops in the vicinity. However, local security must always be posted.

■ 19. ON MARCH.—a. *General.*—When marching as part of the battalion and when not detailed as advance or flank guard, security consists of being alert to repel any sudden attack either from the ground or the air. Detail some men to watch to both flanks. Action when detailed as advance guard is covered in paragraph 20.

b. *Halts.*—When the column halts, either for the regularly scheduled halt or unexpectedly, leave the road and seek cover



FIGURE 15.—Do not assemble at rallying point and start reorganization before security is provided. Do not crowd vehicles in area.



FIGURE 16.—Post security detachments immediately upon arriving at rallying point.

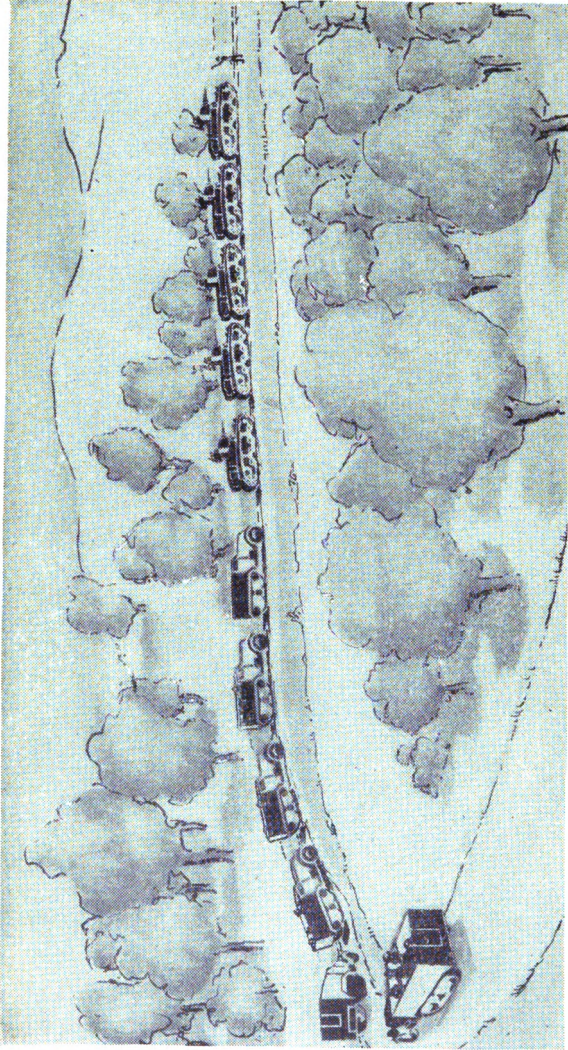

FIGURE 17.—Do not close up at halt. Do not remain on road if it is practicable to get off.

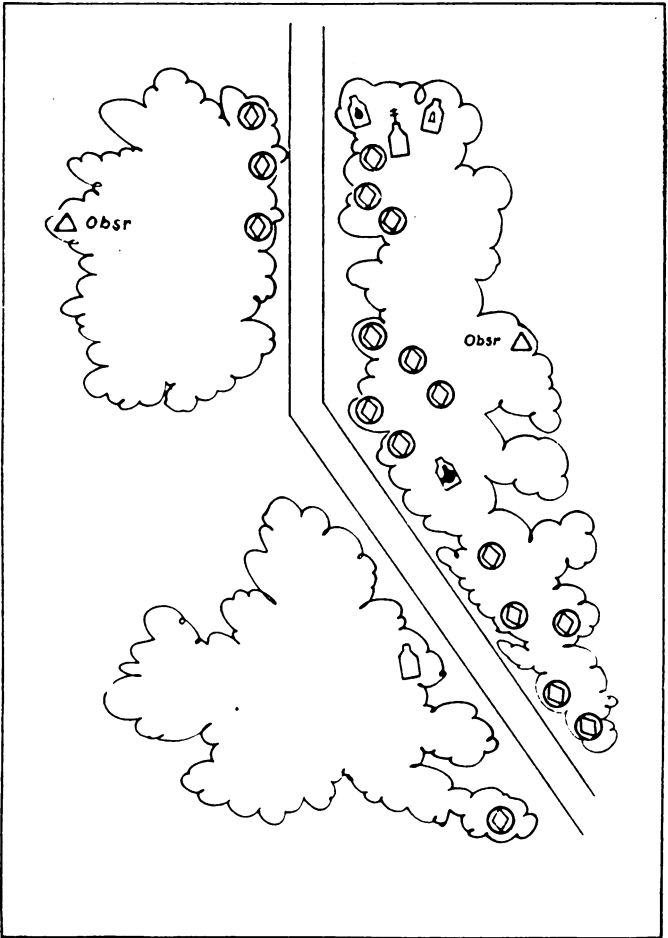

FIGURE 18.—At halt, if concealment is available and side ditches can be crossed, move vehicles to concealed positions. Vehicles are disposed to repel ground attack and dispersed to minimize effect of air attack.

when practicable. **CAUTION:** Do not close up on the road to less than 50 yards. Do not bunch under cover. If cover is available, disperse the vehicles off the road on either side if terrain is suitable. If vehicles cannot be moved off the road keep at least 50 yards between vehicles. Send out observers to the flanks to give warning of enemy approach. Keep some weapons manned at all times.

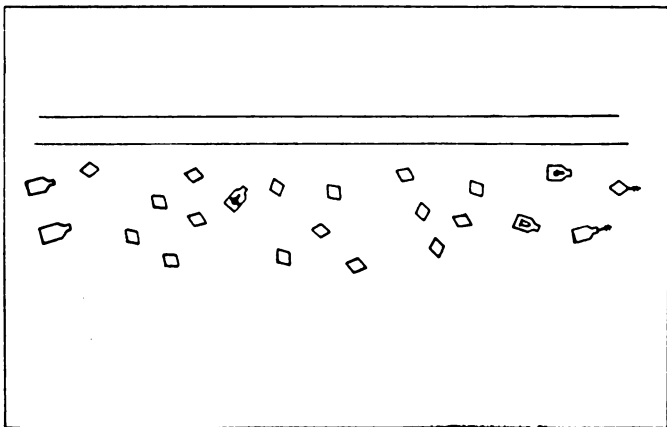

FIGURE 19.—If concealment is not available at halt, move vehicles off road, if practicable, and disperse them.

■ **20. ADVANCE GUARD.**—*a.* The company may be the advance guard for a battalion or the support of an advance guard. When employed as an advance guard it is habitually reinforced with mortars, assault guns, infantry, engineers, artillery, and, in most cases, motorcyclists, and all or a portion of the reconnaissance platoon of battalion headquarters company may be attached.

b. The mission of the advance guard is to secure the uninterrupted advance of the main body. In furtherance of this mission, it must act with speed and boldness. It often attacks direct from march column with little time devoted to reconnaissance and orders.

c. The company commander keeps one of his radio sets tuned to the frequency of the regimental reconnaissance com-

pany, which may be as much as 2 hours ahead. He should be kept informed as to information secured by division or combat command reconnaissance agencies.

d. Before starting the march, the company commander studies the best available maps and secures such information as is available from reconnaissance and other agencies. By map study he determines the most dangerous points along the route, that is, the points at which the enemy could most advantageously attack him. He informs his platoon leaders of these points. He must not, however, get a preconceived idea of the enemy action. Such ideas may lead him into false decisions and disaster. He must constantly study his map and the terrain and determine the best methods of countering enemy resistance, but must not get the idea that the enemy will always attack as he envisions.

e. As an advance guard the company usually has two or more tanks with some $\frac{1}{4}$ -ton trucks and motorcycles as a point. The point is followed at from $\frac{1}{2}$ to 1 minute by the advance party. The remainder of the company is the support. The distance between elements of the advance guard depends upon the terrain. The more open the terrain the greater the distance. Connecting files of motorcyclists or $\frac{1}{4}$ -ton trucks are used between elements of the advance guard.

f. The company commander, with the artillery observer, marches between the advance party and the support. The platoon leaders of the support march at the head of the support where they will be readily available for receiving orders.

g. Figure 2i shows an advance guard action. The point is fired upon by antitank guns defending a road block. The advance party commander had observed this action from the hill, placed his tank's support gun and mortar in position, and fired on the enemy. The company commander, with the artillery observer, joins the advance party commander, signals his platoons to go off the road to the right and left, and for the platoon leaders to join him. He makes a rapid estimate of the situation, and orders an immediate attack. The attack shown is one solution only. The decision must be based on the enemy situation and the terrain.

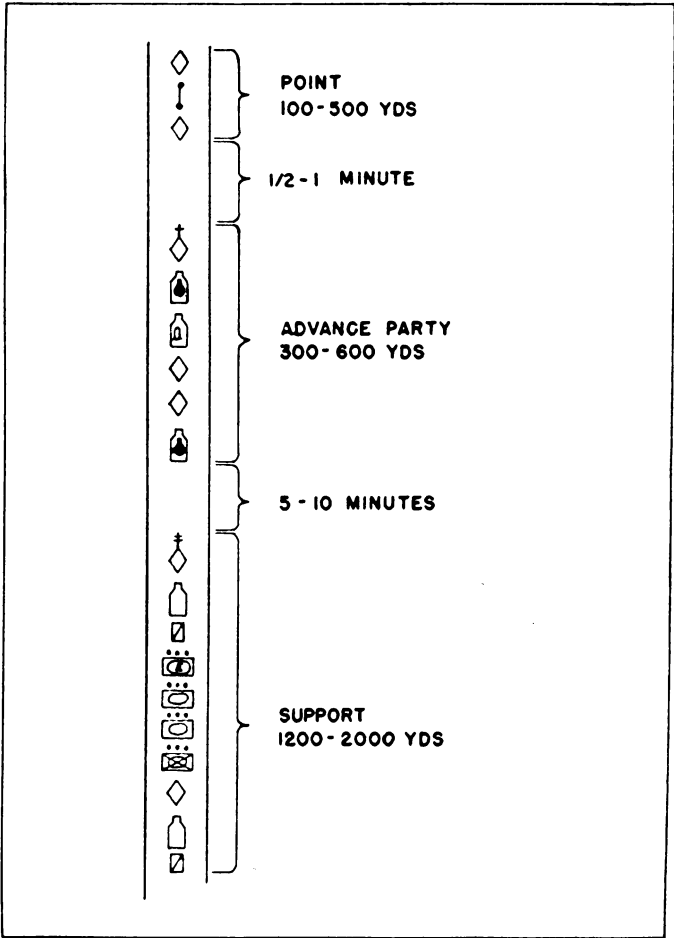

FIGURE 20.—One proposed formation for company acting as advance guard.

■ **21. FLANK GUARD.**—Flank guard formations and actions are similar to the advance guard. However, the flank guard commander can expect little assistance from the main body. His

Generated at Library of Congress on 2022-12-15 16:10 GMT / https://hdl.handle.net/2027/uc1.a0009351198 Public Domain. Google-digitized / http://www.hathitrust.org/access_use#pd-gooole

mission is to protect the main body from surprise and to protect its development. He must do this to the full extent of his available means. He may fight a delaying action or he may attack to disorganize the enemy.

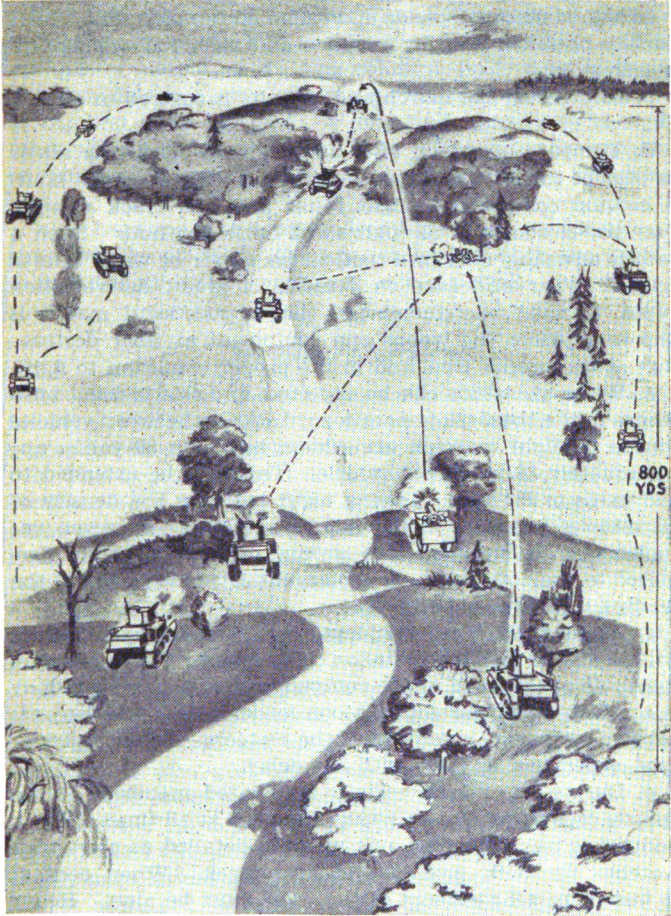

FIGURE 21.—Advance guard action. Assault gun fires on AT guns.

SECTION V

MARCHES

■ 22. GENERAL.—*a.* The subject of marches is covered in detail in FM 17-10, 17-50, and 25-10.

b. A good march depends upon good march discipline. This can be obtained only by practice and rigid enforcement of march rules.

c. Security on the march and at halts is covered in section IV.

d. The rate of march of a tank column consisting all or in part of medium tanks does not exceed 20 miles per hour. A column composed of light tanks and half-track vehicles may travel at a rate as high as 30 miles per hour. Such a rate is advisable only in a tactical maneuver or when time is crucial. Wear and tear on vehicles is great, deterioration rapid. It must be remembered that a successful march is one that places the troops and equipment at their destination at the proper time and in the proper condition to fight.

e. When air attack can be expected, and this is usual anywhere in the theater of operations, distances between vehicles during daylight marches are seldom less than 80 yards, approximately 88 yards per vehicle. This may be extended to 176 yards or 0.1 mile. During night marches the density of 20 vehicles per mile should not be exceeded. However, vehicles may be grouped into groups of approximately five, closed to short distance. A good night driver is placed in the leading vehicle of each group.

f. When combat is imminent, the company commander will usually be with the battalion commander. Platoon leaders assemble at the head of the company column. The company is conducted by the senior platoon leader. Platoon sergeants assume temporary command of the platoons. By such groupings, orders can be given with less delay.

g. During the march certain designated members of the vehicle crew must remain awake and alert at all times. When contact is not imminent, one member detailed as alert man watches for both ground and air attack. When contact is imminent all members of the crew must be alert. Heavy guns are loaded or prepared for loading. Machine guns are

half-loaded. Everything is made ready for instant action. Certain men are detailed as air and ground guards to give instant warning of attack. *Do not let yourself be surprised.*

■ 23. HALTS.—*a.* Halts are usually made for 15 minutes after the first 45 minutes of march. Thereafter, halts of 10 minutes are made at the end of 1 hour and 20 or 1 hour and 50 minutes of marching. In long columns, halts must be made on a schedule as most of the troops will not be out of bivouac at the end of 45 minutes. A long halt, usually $\frac{1}{2}$ hour, is made after 4 hours of running time. This is for the purpose of refueling. Again, in long columns this must be a scheduled halt.

b. Drivers and tank commanders make regular inspection of their vehicles at halts. One man must be left in the vehicle to man the vehicular weapons in case of attack.

SECTION VI

OFFENSIVE ACTION

■ 24. GENERAL.—*a.* The tank is an offensive weapon. Its offensive powers of mobility, fire power, shock action, and armor protection should be exploited to the limit.

b. The tank company will habitually be reinforced during combat. (See sec. I.) The company may be used either alone or as part of the battalion. It is used alone in advance, rear, and flank guards, and may be used alone as a covering force. As part of the battalion it may attack—

(1) As the first echelon of attack, the mission of which is to destroy enemy antitank defenses, artillery, command posts, and other rear installations.

(2) As the second echelon of attack, the mission of which is to destroy infantry targets, especially machine guns, heavy weapons, and antitank guns passed over by the leading echelon. It also destroys command posts, communication centers, and other rear installations.

(3) As the third echelon of attack, which advances with the infantry and destroys enemy machine guns and other enemy installations holding up the infantry.

c. It must not be assumed that the tanks always attack first. Many times the infantry will attack to secure ground from which the tanks may attack.

d. In attack battalions are usually given zones of action. Companies are assigned a frontage and direction of attack. Zones and frontages must not be so narrow as to restrict maneuver.

■ 25. ASSEMBLY.—a. Before any attack, except in repelling a surprise counterattack or when attacking direct from march column, the company will occupy an assembly area or intermediate positions where tanks are repaired and everything made ready for battle.

b. Security in assembly areas is discussed in section IV.

c. The assembly area is selected by the battalion or higher unit commander. A battalion guide or staff officer should indicate the area to the company commander.

(1) The area should afford concealment, should not be within range of hostile medium artillery, should have good standings for vehicles, and should have good routes available for entrance and exit.

(2) The area is occupied in such manner that units are in proper formation to move direct to attack positions without going through the areas of other troops.

(3) The company commander, riding behind the battalion commander in column, is given his area assignment. He divides the area into platoon areas and leaves a guide, usually the communication sergeant in the ¼-ton truck, to guide the platoons to their positions.

(4) Immediately upon moving into the area, tanks are dispersed, security is established, vehicles concealed, and necessary maintenance performed.

(5) In moving into an area at night, a guide must be provided for each platoon. After a platoon reaches its position, each tank must be guided to its place by the tank commander.

(6) The road must be cleared rapidly. Vehicles must not jam on the road. Tracks into the area are brushed out to prevent disclosure of the position to hostile aircraft. (See FM 21-45.)

(7) Platoon leaders establish a platoon CP, and send a runner to the company CP. The company commander reports to or sends a runner to the battalion commander. The bugler is used as a messenger.

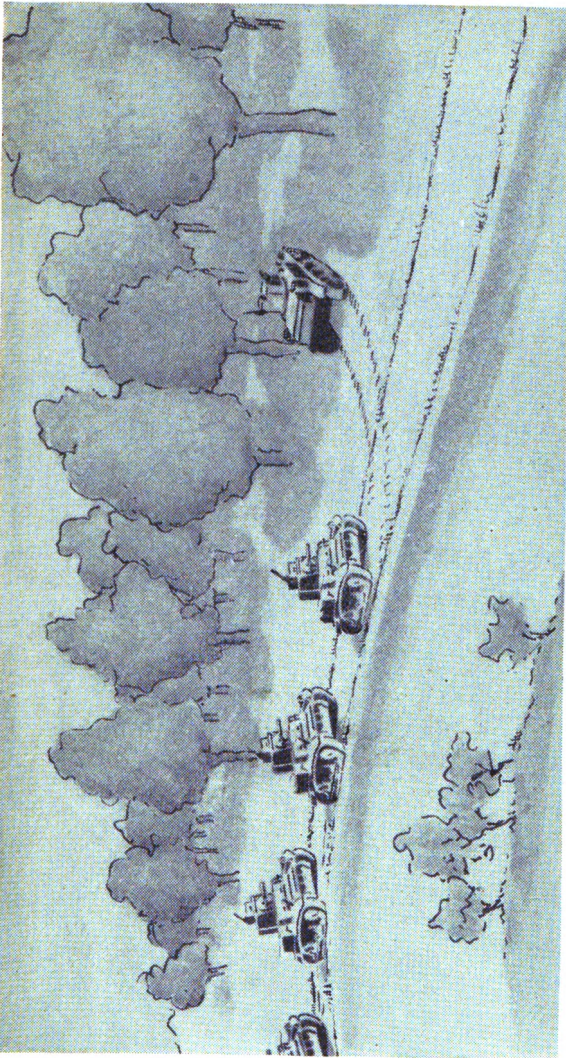

FIGURE 22.—Do not move into assembly area without posting guides. Columns will jam on road and may become disorganized in area.

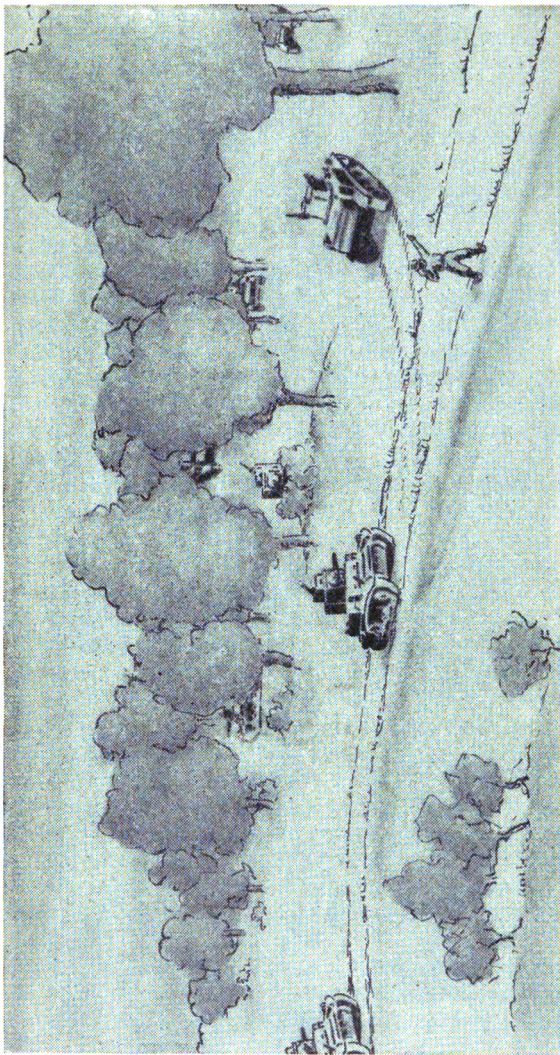

FIGURE 23.—Post guides at entrance of assembly area to indicate platoon areas.



FIGURE 24.—Do not move into assembly area and let crews remain idle.



FIGURE 25.—In assembly area, crews check tanks and get ready for action.

d. The attack position is as close to the line of departure as is consistent with concealment. Here last-minute checks are made and last-minute orders given. It is here that last-minute coordination is made with infantry when tanks attack through infantry.

■ 26. FORMATION.—*a.* Figure 26 shows typical formations for a tank attack. It should be noted that the diagrams show only one formation for the platoons. These may be in any prescribed combat formation such as line, wedge, column, echelon, or line of section columns, depending upon terrain and hostile dispositions.

(1) The formation of three platoons in line is seldom used. It provides no reserve, is difficult to control, and has no power for sustained effort. It may be used by a covering force.

(2) The formation of two platoons in the assault is easier to control than line formation and affords a reserve for influencing the action, but has less sustaining power than column formation. The support company is usually disposed toward the exposed flank.

(3) Column formation affords maximum control and sustained power. It is the formation for a penetration when the company is not supported by another company. It has the disadvantage of developing very little initial fire power.

(4) Another formation not shown in the diagram is one platoon in assault and two platoons in reserve. This formation is suitable when the situation is vague. Deployment to right or left is facilitated.

b. During the approach to combat the company commander is at the head of his company. When the attack begins he goes wherever he can best influence the action. He will usually seek an observation point, probably close to the firing positions of his tank platoon supporting the attack, from which point he will be able to watch the attack of his platoons. Here he controls by radio the maneuver of the platoons and uses his reserve at the proper time. He should not lead the initial attack unless such action is necessary for psychological purposes. When he leads the attack he will become engaged in combat and will be unable to control his company.

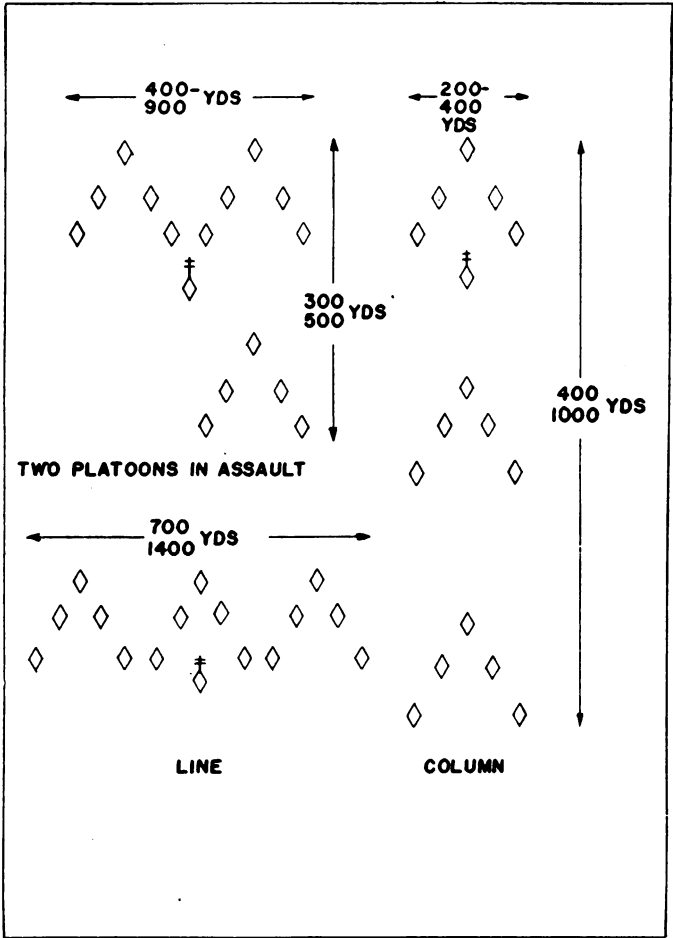

FIGURE 26.—Formations for attack. Platoons may be in line, wedge, inverted wedge, column, line of section columns, or echelon.

Generated at Library of Congress on 2022-12-15 16:10 GMT / https://hdl.handle.net/2027/uc1.a0009351198
 Public Domain, Google-digitized / http://www.hathitrust.org/access_use#pd-google

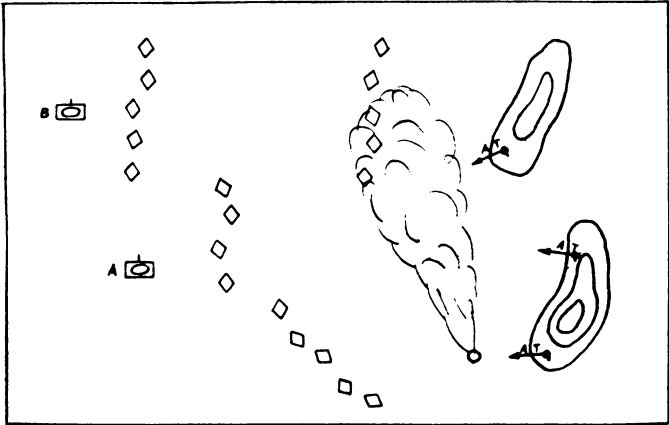

FIGURE 27.—Do not use so much smoke that maneuver of adjacent units will be affected. Here smoke laid down by company hinders movement of Company B. (See also fig. 28.)

■ 27. USE OF SMOKE.—*a.* Smoke is used by tank units to—

- (1) Screen movement of tanks.
- (2) Blind hostile observation.
- (3) Neutralize hostile antitank guns.
- (4) Confuse the enemy as to the real point of attack.

b. The use of smoke in any great quantity must be coordinated by higher commanders. Even one mortar can, if there is a cross wind, lay down a smoke screen that will hinder the movement of adjacent friendly troops.

c. Each medium tank and each assault gun has a limited number of rounds, usually five, of smoke ammunition. They cannot lay down an extensive smoke screen. This ammunition is used only for temporarily blinding observation of antitank guns so the vehicle may close with the gun or move to a more favorable position. The 81-mm mortar of the tank battalions carries a preponderance of smoke ammunition. Its high rate of fire, 30 rounds per minute, allows it to lay down a heavy smoke screen in a short time. (See FM 17-27.)

d. For screening small targets a cross wind is best, as only one round if fired to windward will suffice for concealment.

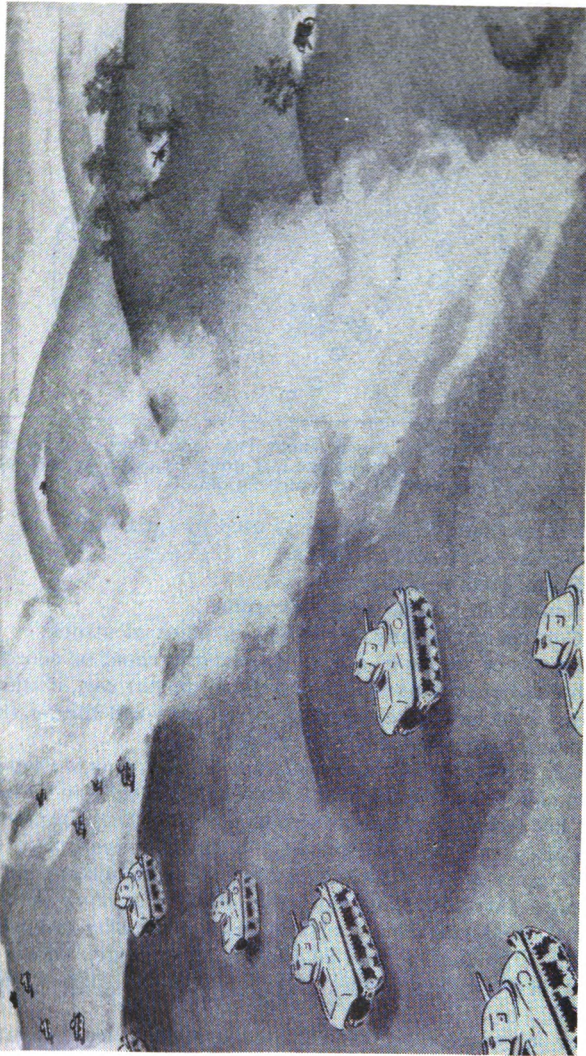

FIGURE 28.—Do not use so much smoke that maneuver of adjacent units will be affected. Here smoke laid down by company hinders movement of Company B. (See also fig. 27.)

However, a cross wind will blow smoke into the zone of the adjacent unit and fire must be controlled.

e. For screening an attack a wind blowing directly toward the enemy position is best. Smoke laid in front of the enemy position will drift to the rear and cover rear areas as front areas become free for attack. **CAUTION:** *Do not lay a smoke screen when the wind is blowing from the enemy toward you unless you desire to withdraw.*

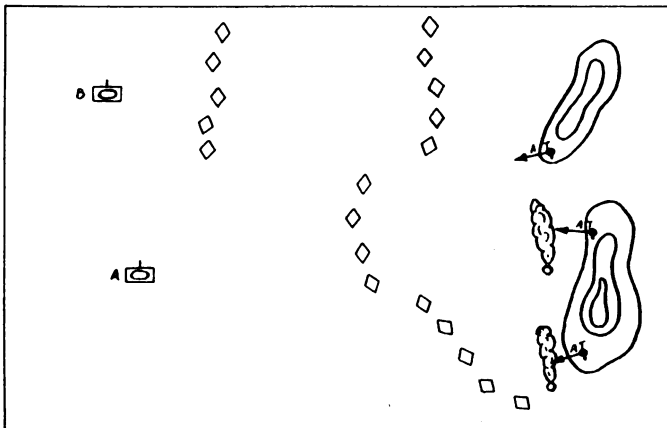

FIGURE 29.—Lay only enough smoke to conceal your own targets. (See also fig. 30.)

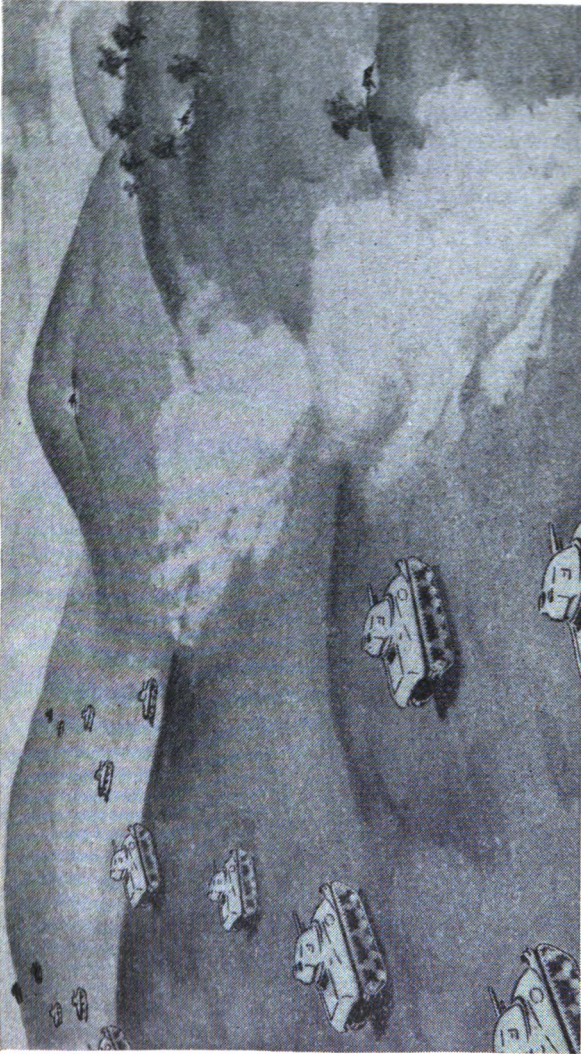

FIGURE 30.—Lay only enough smoke to conceal your own targets. (See also fig. 29.)

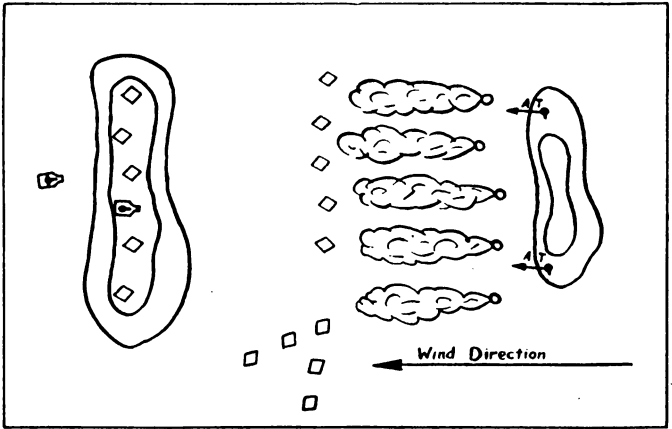

FIGURE 31.—Do not lay smoke that will come back on you. (See also fig. 32.)

Generated at Library of Congress on 2022-12-15 16:10 GMT / https://hdl.handle.net/2027/uc1_a0009351198
Public Domain, Google-digitized / http://www.hathitrust.org/access_use#pd-google

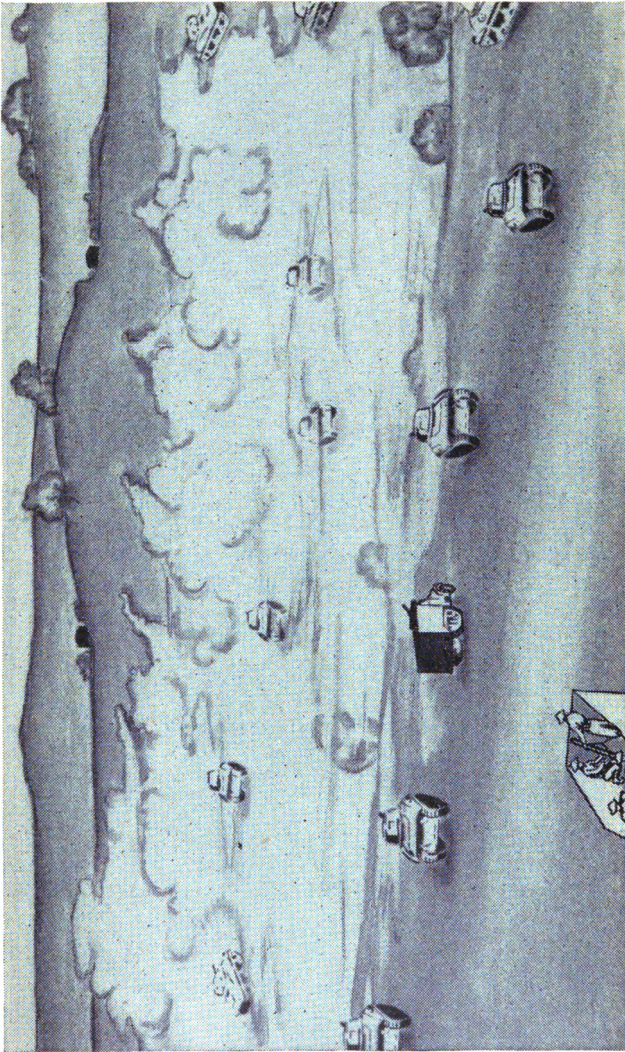

FIGURE 32.—Do not lay smoke that will come back on you. (See also fig. 31.)

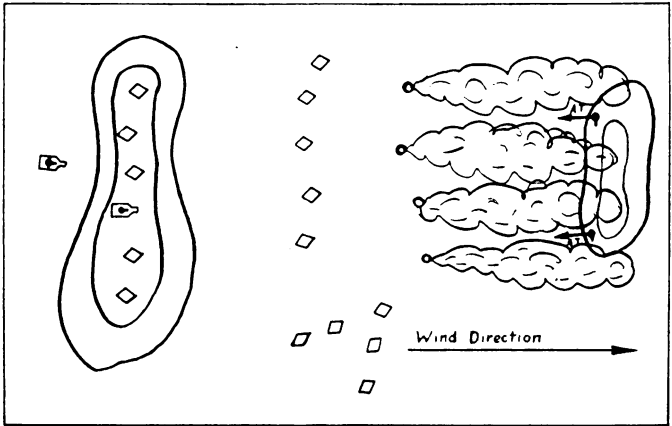

FIGURE 33.—Smoke laid with wind down range is most effective. It continues to cover hostile rear installations. (See also fig. 34.)

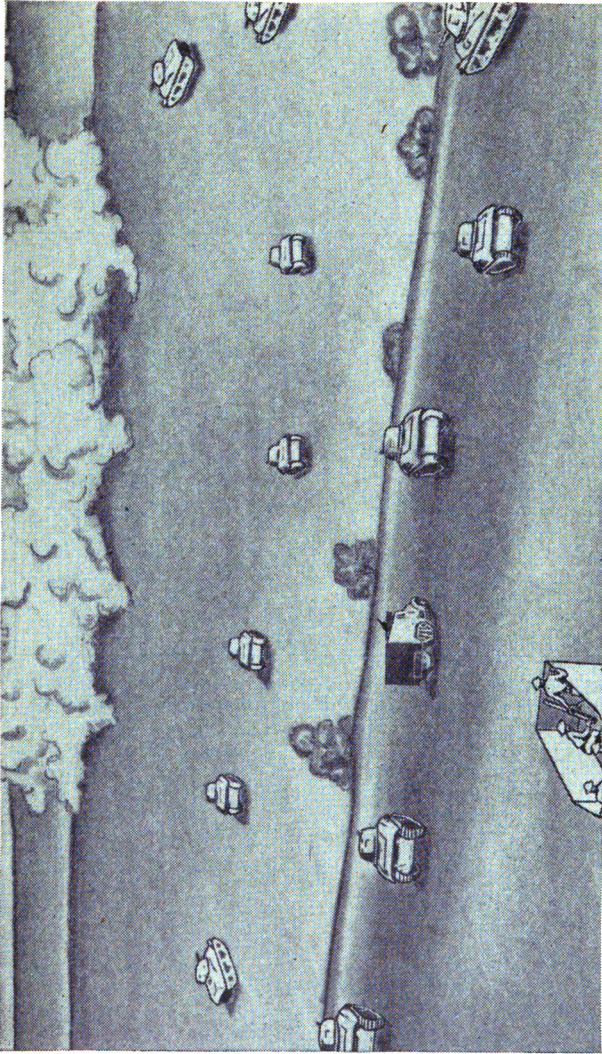

FIGURE 34.—Smoke laid with wind down range is most effective. It continues to cover hostile rear installations. (See also fig. 33.)

■ 28. **ATTACK FROM MARCH COLUMN.**—*a.* When unexpectedly attacked by the enemy or in a meeting engagement when time is essential, attack may be made direct from march column, with halt made only long enough to issue orders and perform the minimum of reconnaissance.

b. If the column is unexpectedly attacked from the flank, each platoon moves directly to the attack. It rallies on the road or at such other place as the company commander may direct by radio. The platoon leader gives his order for attack by radio and at the first opportunity reports to the company commander. When platoon leaders are at the head of the company column they must, with all possible speed, return to and assume command of their platoons.

c. Meeting engagement has been covered in advance guard action (par. 20).

d. When attacking unarmored troops, move quickly into action, overrun and destroy the enemy.

e. When attacking armored troops from march column, maneuver to bring maximum fire on a portion of the enemy, while containing the remainder with a small force or blinding him by use of smoke. Fire, if practicable, from concealed positions with tank stationary. If you are caught in the open by heavier tanks with heavier weapons, use smoke on part of the enemy and close rapidly with the remainder. Unless you can withdraw and lead the enemy tanks into the fire of your own supporting medium tanks, your best chance is to get to close range where your weapons will be effective. Use maximum speed.



FIGURE 35.—Do not keep units on road while reconnaissance is being made and orders are being issued. Such inaction invites destruction by artillery fire.



FIGURE 36.—Move rapidly off road and prepare for action.

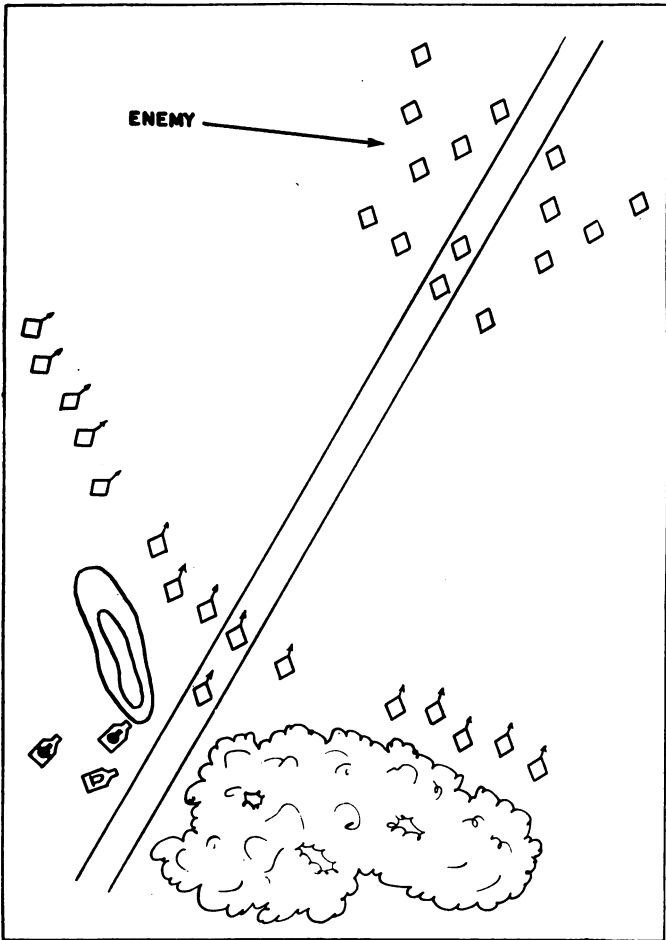

FIGURE 37.—In meeting engagement with armored troops do not rush to meet enemy in frontal attack in open.

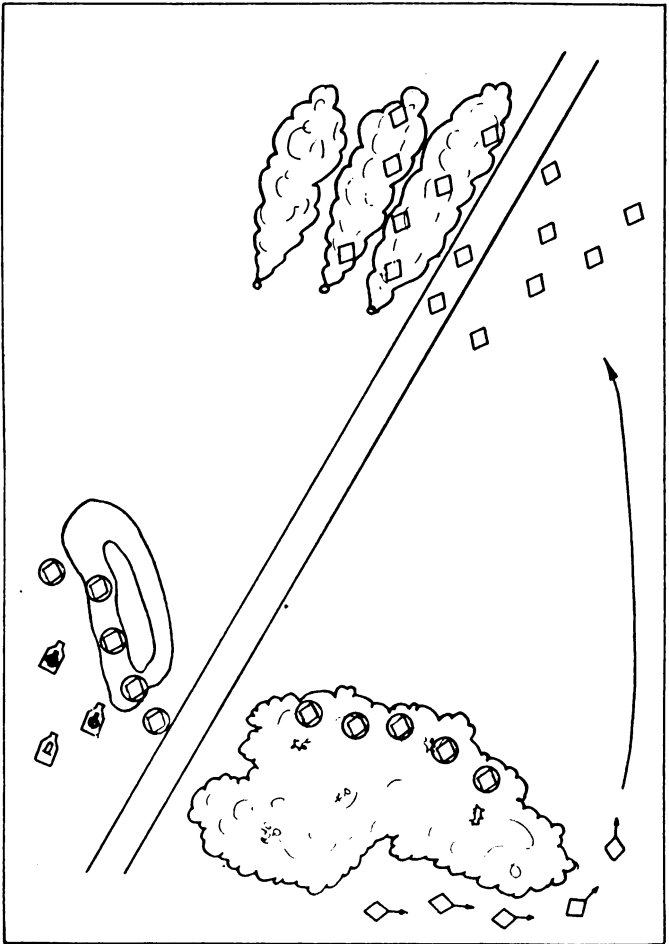

FIGURE 38.—Maneuver to position where concentrated fire can be brought on part of enemy. Detain rest of his forces by use of smoke, if practicable.

■ **29. ATTACK OF POSITION.**—*a.* Such attacks are preceded by movement into assembly areas, reconnaissance, and movement to attack positions. Such attacks may be penetrations or envelopments. When one or both of the enemy's flanks are open, envelopment is usual. Penetration is followed by envelopment of the flanks created.

b. Attack of a position is characterized by coordination of all fires, artillery, mortars, assault guns, supporting tanks, and dive bombers. When the enemy position is held in strength and is protected by mine fields, the infantry usually attacks first, protected by artillery and mortar fire. When mine fields or tank obstacles are to be removed, infantry and engineers, protected by smoke and heavy artillery and machine-gun fire, remove mines and make paths for the tanks. The tanks then attack through the gaps created.

c. Tanks may attack ahead of infantry to break down wire entanglements and destroy hostile automatic weapons.

d. Artillery fire must lift when tanks approach within 300 yards of its target. The protection afforded by the artillery is taken over by the assault guns, mortars, and supporting medium tanks. Economy of ammunition must always be considered. Medium tanks and assault guns cannot lay down sustained artillery fire.

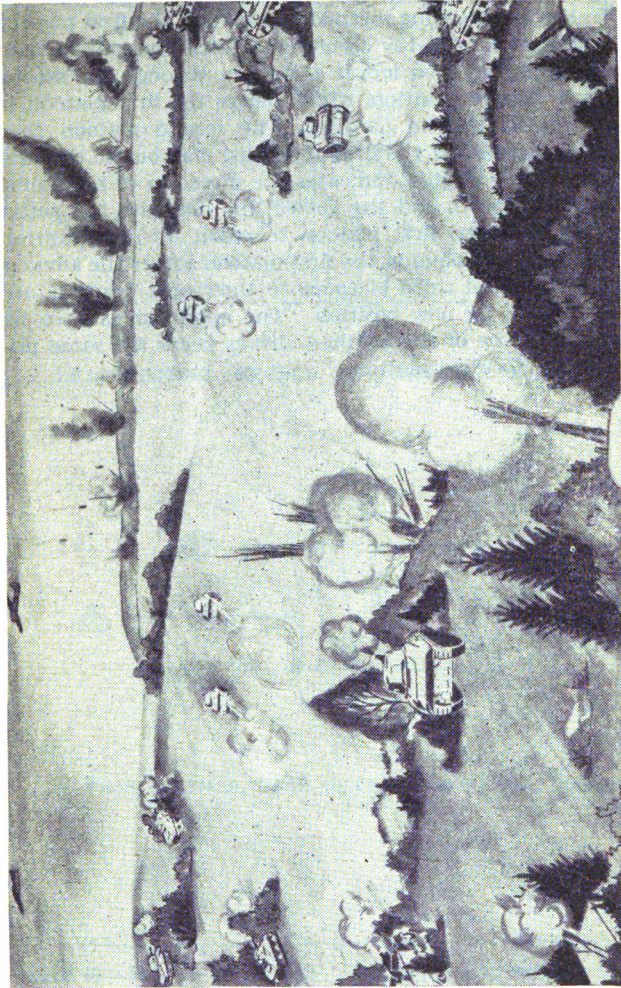

FIGURE 39.—Attack of position.

■ **30. METHOD OF ADVANCE.**—Advance is made by leapfrogging or other means of fire and maneuver. (See fig. 40.)

a. In the leapfrogging method of advance, the first platoon covers the advance of the second and third platoons to their next position and then moves around or through the second platoon to its new position, which places the first platoon in advance of the second platoon. The second platoon then covers the advance of the first and third platoons to the next position. The solid line indicates the direction of movement of the first platoon, and the dotted line indicates the actual route taken by the first platoon to reach its new position.

b. In moving by bounds, the first platoon covers the advance of the second and third platoons to their next position, and then moves to its new position. The operation is then repeated. The use of this method always keeps the same platoons in the forward positions.

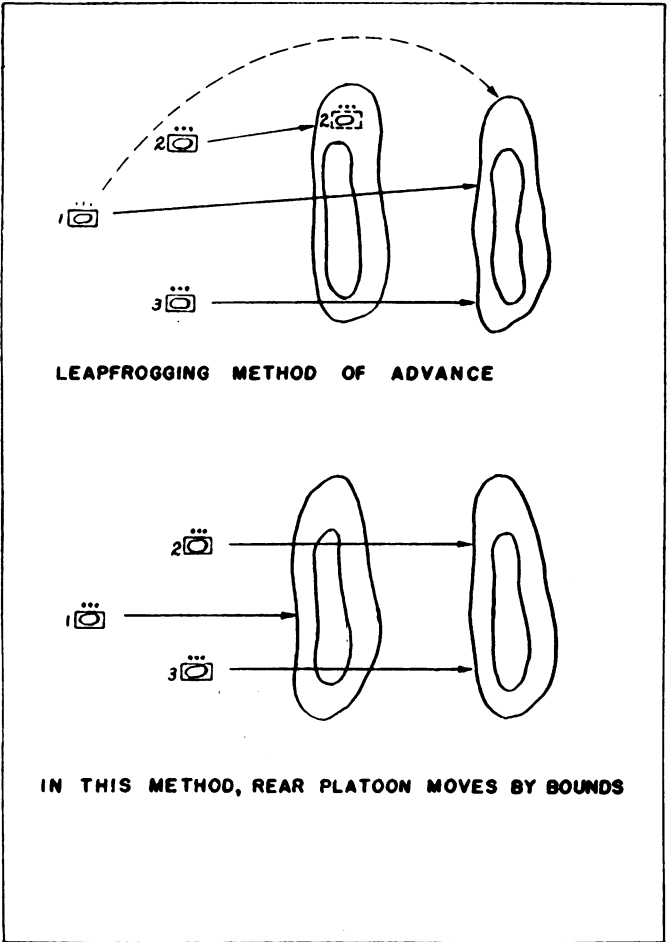

FIGURE 40.—Method of advance. One platoon covers the advance of other platoons.

■ 31. **ATTACK WITH INFANTRY.**—*a.* The infantry may attack ahead of the tanks, with the leading wave, or with the rear echelon. It may be in carriers or dismounted, depending upon the strength of the enemy. It must dismount when taken under heavy enemy fire.

b. In a vague situation infantry will advance with a light tank company. It will follow one of the tank platoons in carriers until serious resistance is met. It may then be used to form a base of fire for the tank attack; to attack supported by tank, mortar, and assault gun fire; to destroy resistance which cannot be reached by tanks; to maneuver dismounted to the flank to destroy enemy antitank guns holding up an attack. There must be liaison between the tank company commander and the infantry commander. The infantry platoon commander has an SCR-510 radio set with which he may communicate with the tank company commander. Should he not have the proper crystals for this communication, the tank company commander uses his own half-track as a liaison vehicle, causing it to move with the infantry platoon commander.

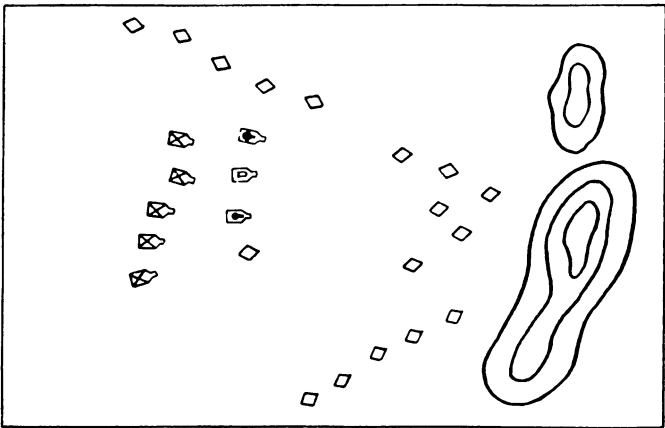

FIGURE 41.—Advance with infantry following in carriers. Situation vague. (See also fig. 42.)

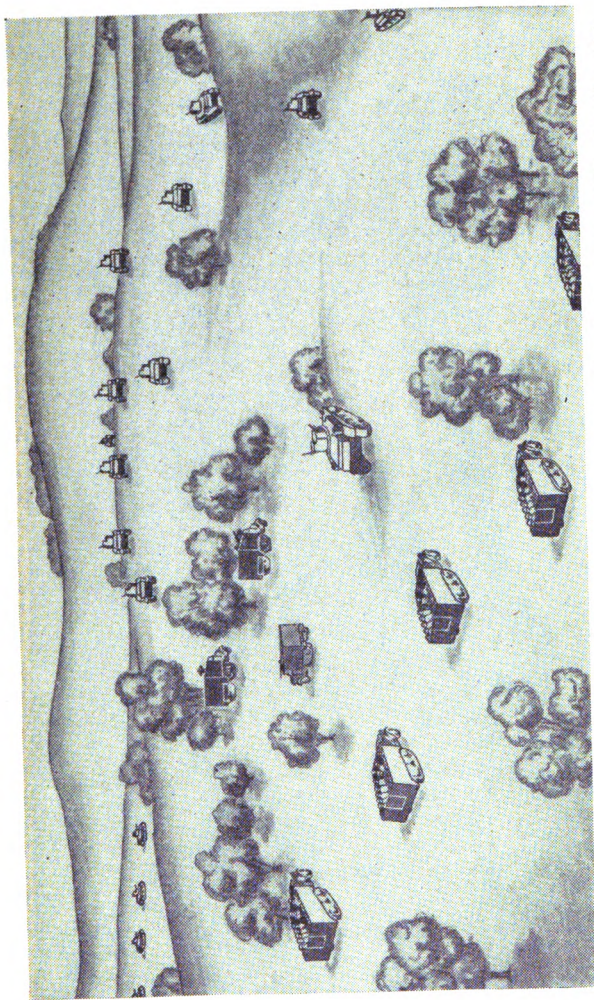

FIGURE 42.—Advance with infantry following in carriers. Situation vague. (See also fig. 41.)



FIGURE 43.—Advance with infantry dismounted.

■ 32. ACTION WHEN ENEMY LAYS DOWN SMOKE SCREEN.—*a.* In smoke or fog, tanks lose direction, may crash into each other, and will be forced to slow down. Maintenance of direction is difficult at best. The tank compass will be hard to see if smoke gets into the tank.

b. When a tank platoon or company commander sees that his unit is about to be smoked, he orders the tanks to move at maximum speed to defilade positions. Some tanks on the flanks dispose themselves to protect the flanks to repel a counterattack that may be following the smoke screen. All prepare immediately to resume the advance at maximum speed when the smoke clears. The support platoon and assault gun prepare for immediate resumption of fire. These may be moved to a more favorable position to bring fire on the enemy.

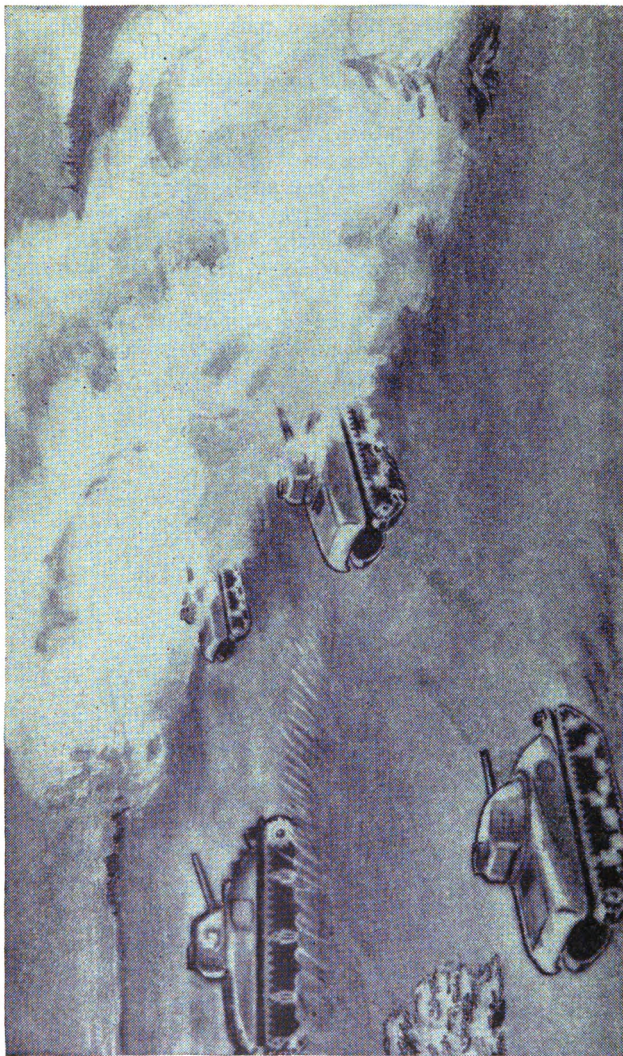

FIGURE 44.—If smoke cloud hits you, do not move on through it.



FIGURE 45.—If you continue, tanks will lose direction and antitank gunners will have good targets.

Generated at Library of Congress on 2022-12-15 16:10 GMT / https://hdl.handle.net/2027/uc1.a0009351198
Public Domain, Google-digitized / http://www.hathitrust.org/access_use#pd-google



FIGURE 46.—If smoke cloud approaches, seek concealment or deflade even if you have to withdraw slightly.

■ 33. **ATTACK OF ARTILLERY POSITION.**—Do not attack artillery frontally. Cover the artillery with machine-gun fire from the front or flank and send platoons to the right and left. Attack it from the flanks and rear and overrun the battery position.



Figure 47.—Do not attack artillery frontally.

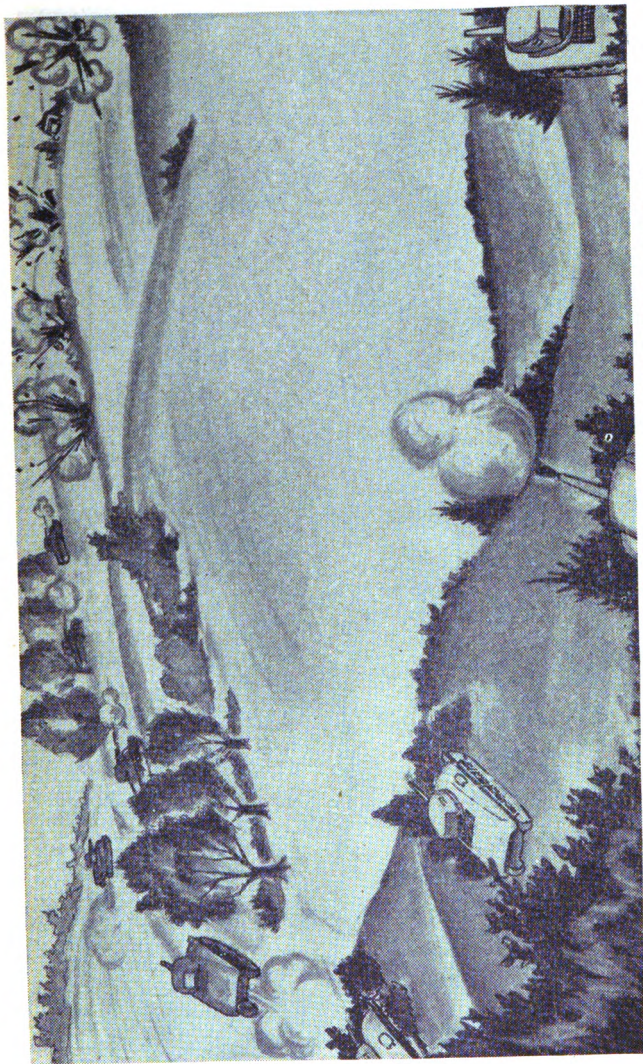

FIGURE 48.—Cover artillery with fire and attack from flanks and rear.



FIGURE 49.—Do not attack across mine field.

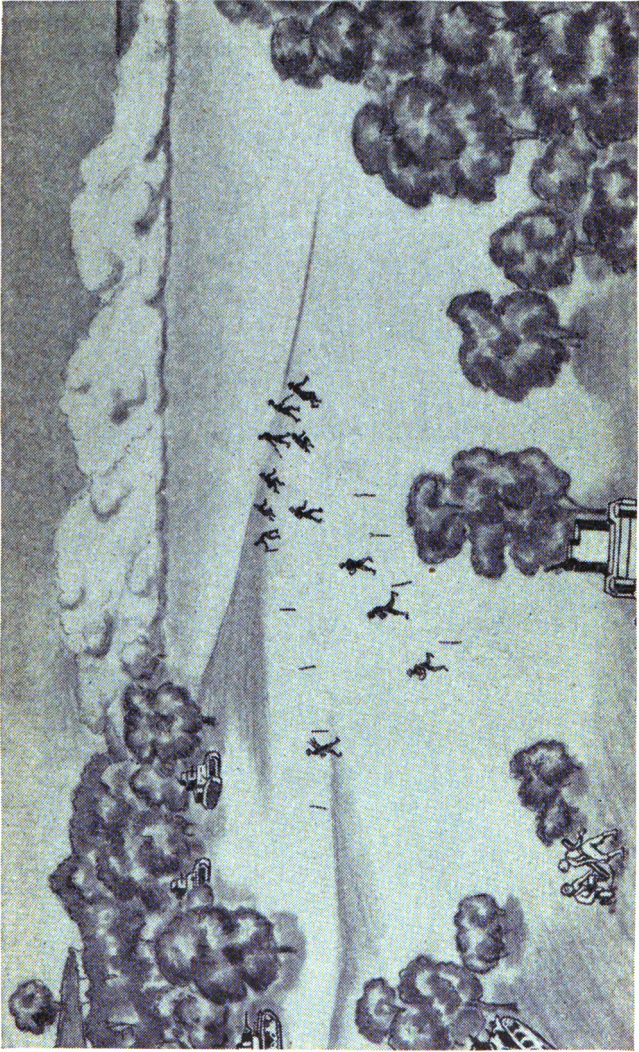

FIGURE 50.—Go around mine field or have infantry and engineers clear path.

■ 34. **ATTACK OF VILLAGES.**—Avoid villages if practicable. If the village must be taken, use infantry, engineers, mortars, and assault gun to attack frontally while tanks encircle the town.

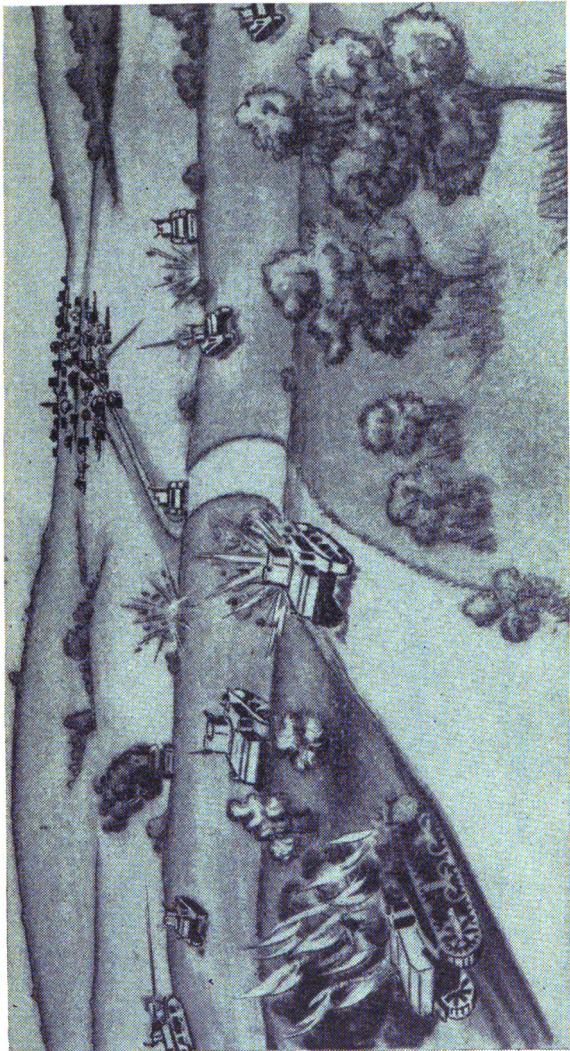

FIGURE 51.—Do not attack village frontally with tanks if such action can be avoided.



FIGURE 62.—Use infantry to attack frontally and tanks to encircle town.

■ 35. **ATTACK IN WOODS.**—To maintain control move through woods in column. Beware of paths, as they will probably be mined or covered with AT guns. If necessary have infantry or other dismounted men precede tanks.

■ 36. **ATTACK OF FORDS.**—In attack of fords place tanks in defiladed position to take defenders under fire and use infantry to attack flank or rear.

■ 37. **ATTACK OF RIVER LINE.**—In the attack of a river line, engineers, supported by artillery and some medium tanks close to the river bank, ferry infantry and tank destroyer units across. They then build the bridge. Medium tanks supporting the crossing are disposed under cover or in defiladed positions close to the river bank where they can give close protection to the engineers.

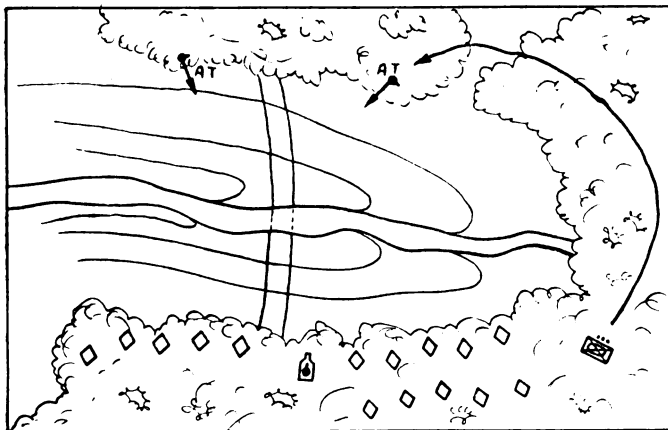

FIGURE 53.—Attack of ford.

SECTION VII

DEFENSE

■ 38. **GENERAL.**—*a.* The tanks' offensive power must be used in defense for counterattacks. They are not used as stationary pill boxes except as a last resort. FM 17-10 covers in general the employment of armored units in defensive combat.

b. In defense, infantry and engineers hold the main line of resistance while tank units form the reserve for counter-attacking hostile forces preferably before they reach the infantry lines.

■ 39. DEFENSE OF A POSITION.—In defense of a position, the tank company will normally operate as part of the battalion. (See FM 17-33.) Here it is used to attack as described in section VI. In the defense, careful reconnaissance is made of all terrain over which a counterattack might be made and arrangements made with local infantry commanders for passage of lines and coordination of fires.

■ 40. WITHDRAWAL.—In withdrawal, tanks are used as counterattack forces to make shallow attacks on a wide front to slow up the enemy attack and permit friendly troops to withdraw and reform. The company will usually be with the battalion. In these attacks, the rallying point is normally the attack or assembly position.

■ 41. DELAYING ACTION.—Delaying action is similar to withdrawal, the tanks being used to attack the heads and flanks of hostile columns. In delaying action do not allow yourself to become so heavily engaged as to be unable to withdraw.

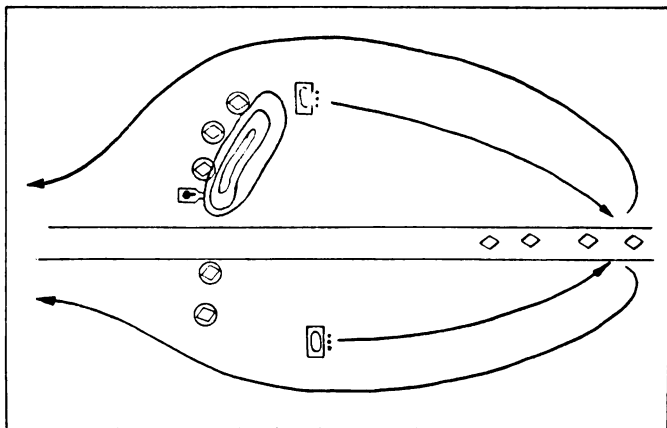

FIGURE 54.—Delaying action. Support attack of two platoons by one platoon. One platoon then protects withdrawal of attacking platoons.

■ 42. REAR GUARD.—Formations of the rear guard are the same as the advance guard except in reverse order. The rear guard may have to fight a delaying action. It can expect no help from the main body.

SECTION VIII

JUNGLE WARFARE

■ 43. GENERAL.—*a.* FM 31-20 covers the general subject of warfare in the jungle. In general, because of their sensitiveness to terrain, tanks are unsuited for mass employment in jungles. Their use in such operations will usually be limited to groups of a company or less, supported by infantry. A tank platoon might be attached to an infantry company.

b. Light tanks are more suited to jungle operation than medium tanks.

c. Operation in jungles is usually confined to narrow trails through dense growth relieved at intervals by open spaces. Much of the trail may be swampy and require pioneer work of considerable extent before the tanks can traverse it.

■ 44. ATTACK.—Infantry leads on the jungle trails, develops the enemy, and the tanks then attack. Such operations are a continuous series of small attacks; at one time tanks lead and the next, infantry.

■ 45. DEFENSE.—*a.* Infantry defends the trails by placing antitank mines and machine guns to cover them. The open spaces are covered by fire. The tanks are held in reserve to counterattack if the enemy succeeds in reaching the open space.

b. Tanks may be used to delay the enemy by turning the turret guns to the rear and withdrawing from one vantage point to another.

APPENDIX

TROOP LEADING

	Paragraphs
SECTION I. On the march, part of a battalion.....	1-5
II. Meeting engagement.....	6-10
III. Attack of position from assembly area.....	11-13

SECTION I

ON THE MARCH, PART OF A BATTALION

- 1. WARNING ORDERS RECEIVED.—*a. Company commander.*—
- (1) Alerts company.
 - (2) Gives information to officers and first sergeant.
 - (3) Proceeds in half-track, with communication-liaison-reconnaissance truck to battalion CP.
 - b. Platoon leaders.*—Prepare platoons for march.
 - c. Maintenance officer.*—Supervises maintenance.
 - d. First sergeant.*—Prepares administrative, supply, and mess sections for the march.
 - e. Communication sergeant.*—Checks and repairs radios.
- 2. COMPANY COMMANDER RETURNS FROM BATTALION CP.—*a. Company commander.*—Issues orders for march, giving route, order of march, and other essential information.
 - b. Platoon leaders.*—(1) Give orders to platoon.
 - (2) Complete preparation for march.
 - c. Maintenance officer.*—Completes maintenance work.
 - d. First sergeant.*—(1) Completes arrangements for march.
 - (2) Asks where rear echelon is to report.
 - e. Communication sergeant.*—Checks and repairs radios.
- 3. DURING MARCH.—*a. Company commander.*—(1) Rides behind battalion commander if so ordered.
 - (2) If with company—
 - (a) Marches at head of company.
 - (b) Regulates march.
 - (c) Causes communication sergeant to check column.

b. Platoon leaders.—(1) Ride at head of company if so ordered.

(2) If not at head of company, ride at head of platoon.

(3) Detail air and ground alert guards.

c. Maintenance officer (second-in-command).—Rides at tail of column, where he supervises maintenance.

d. Maintenance sergeant.—(1) Rides at tail of column.

(2) Repairs vehicles as necessary.

e. Communication sergeant.—(1) Rides column.

(2) Reports to commanding officer or maintenance officer.

f. First sergeant.—(1) Joins trains as directed.

(2) Commands rear echelon.

■ **4. AT HALTS.**—*a. Company commander or second-in-command.*—(1) Checks column.

(2) Posts security groups.

(3) Gives any necessary orders.

(4) Moves vehicles under cover when practicable.

b. Platoon leader.—(1) Moves platoon under cover, if practicable.

(2) Inspects platoon.

(3) Causes crews to inspect vehicles.

(4) Checks on fuel.

(5) Posts dismounted security.

c. Maintenance officer.—Supervises maintenance.

d. Maintenance sergeant.—Supervises maintenance.

e. Communication sergeant.—Duties as directed by commanding officer.

f. First sergeant.—Commands rear echelon.

■ **5. MOVEMENT INTO BIVOUCAC OR ASSEMBLY AREA.**—*a. Company commander.*—(1) Assigns platoon areas.

(2) Assisted by communication sergeant, guides platoons to areas.

(3) Posts security.

(4) Establishes company CP.

(5) Receives reports of platoon leaders.

(6) Reports in person or by runner to battalion commander.

(7) Makes reconnaissance of routes out of area.

(8) Directs other necessary reconnaissance.

(9) Checks concealment and camouflage.

- b. Platoon leader.*—(1) Moves platoon to assigned area.
- (2) Posts security details.
- (3) Assigns parking place for vehicles.
- (4) Establishes platoon CP and keeps one man on alert.
- (5) Checks concealment, camouflage, dispersion.
- (6) Causes necessary checks and maintenance to begin.
- (7) Reports condition of platoon to company commander.
- (8) Makes reconnaissance as directed.
- (9) Gives instructions for action in emergency.
- c. Maintenance officer.*—Supervises maintenance.
- d. Maintenance sergeant.*—Supervises maintenance.
- e. Communication sergeant.*—Checks radios.
- f. First sergeant.*—Moves to place in train bivouac or to company bivouac as directed.

SECTION II

MEETING ENGAGEMENT

- **6. GENERAL.**—Advance guard action is described below. The actions listed will fit other meeting engagements.
- **7. CONTACT IMMINENT.**—*a. Company commander.*—(1) Marches between advance party and support.
 - (2) Keeps one radio set tuned to regiment reconnaissance company.
 - (3) Studies map and terrain and makes plans for action.
- b. Point commander.*—(1) Advances point, usually by bounds from cover to cover.
 - (2) Keeps alert for hostile troops.
- c. Advance party commander.*—(1) Marches between point and advance party.
 - (2) Covers advance of point by using assault gun, mortar, and stationary tanks as necessary.
 - (3) Watches to flanks.
- d. Company commander* (see above).—(1) Maintains rate of march.
 - (2) Marches between advance party and support.
- e. Platoon leaders.*—(1) March at head of support.
 - (2) Listen on company command net.
- f. Maintenance officer.*—Performs necessary maintenance.
- g. Platoon sergeants.*—Command platoons in absence of platoon leaders.

h. Communication sergeant.—Remains with company commanding officer.

■ 8. WHEN CONTACT IS GAINED.—*a. Company commander.*—

(1) Sends for platoon leaders.

(2) Moves rapidly forward, receives situation from advance party commander, makes hasty reconnaissance, estimates situation, issues orders to platoon leaders, who should be just arriving.

(3) Reports situation to column commander.

b. Point commander.—(1) Overcomes resistance if practicable.

(2) If not practicable, moves vehicles under cover.

(3) Forms base of fire.

(4) Reports to advance party commander.

c. Advance party commander.—(1) Deploys advance party.

(2) Estimates situation.

(3) Puts advance party in position to support point or attacks.

(4) Explains situation to company commander.

d. Platoon leaders.—Join company commander.

e. Maintenance officer (second-in-command).—If with company, moves column off road, under cover.

f. Platoon sergeants.—(1) Senior platoon sergeant takes command of company if maintenance officer is back with disabled vehicles.

(2) Move platoons off road.

(3) Prepare platoons for action.

g. Maintenance sergeant.—Maintenance functions.

h. Communication sergeant.—Duties as directed by commanding officer, to include notifying maintenance officer of situation.

■ 9. DURING COMBAT.—*a. Company commander.*—(1) Observes action.

(2) Gives orders as necessary.

(3) Keeps battalion commander informed of situation.

b. Platoon leader.—(1) Leads platoon.

(2) Keeps company commander informed of situation.

c. Maintenance officer.—Repairs disabled vehicles.

d. Communication sergeant.—Duties as prescribed by commanding officer.

■ 10. AT RALLYING POINT.—*a. Company commander.*—(1)

Posts security.

- (2) Gives instructions for reorganization of company.
- (3) Reports situation to battalion commander.
- (4) Confers with maintenance officer.
- (5) Checks treatment of casualties.
- (6) Reforms company and proceeds on mission.
- (7) Reports situation to battalion commander.

b. Platoon leader.—(1) Leads platoon to rallying point.

(2) Disposes platoon in area assigned, utilizing available cover, concealment and defilade, prepared for all-around defense, ready for instant action.

(3) Posts tanks or individuals at vantage points to obtain observation and protection.

- (4) Reorganizes his platoon.
- (5) Reports status of platoon to company commander.
- (6) Checks treatment and evacuation of personnel.
- (7) Carries out further orders of company commander.

c. Maintenance officer.—Performs maintenance duties.

SECTION III

ATTACK OF POSITION FROM ASSEMBLY AREA

■ 11. PREPARATION FOR ATTACK.—*a. Company commander.*—

(1) Moves forward with platoon leaders.

(2) Contacts reconnaissance unit or rifle unit commander in his area of operation.

(a) Obtains information of friendly and hostile dispositions and of the terrain.

(b) Arranges for passage of lines if that is necessary. Arranges for guides.

(3) Performs reconnaissance, assisted by subordinates.

(4) Decides on plan of employment and issues order, preferably on ground from which salient terrain features may be pointed out.

(5) Notifies battalion commander when company is ready to attack.

b. Platoon leader.—(1) Performs reconnaissance as directed by company commander.

(2) Makes notes on order.

(3) Meets tank commander and drivers, when practicable, at designated time and place.

(4) Performs reconnaissance to determine details of operation for each tank.

(5) Arranges for passage of tanks through foot troops when necessary.

(6) Issues platoon order.

(7) Notifies company commander when ready.

c. Maintenance officer.—Maintenance duties.

■ 12. MOVEMENT TO ATTACK POSITION.—*a. Company commander.*—(1) Precedes company to attack position.

(2) Allots platoon areas.

(3) Meets company when it arrives.

b. Maintenance officer.—Conducts company to attack position.

c. Platoon leader.—Joins company commander; disposes tanks within platoon area, observing requirements for cover, concealment, defilade, and dispersion; checks combat condition of the platoon; orients platoon personnel as to terrain, and insures that each man knows what he is to do; reports readiness for combat to company commander.

d. Platoon sergeant.—Commands platoon in movement forward.

■ 13. DURING COMBAT.—*a. Company commander.*—(1) Reports to battalion commander by radio when company attacks.

(2) From vantage point, observes progress of attack.

(3) Keeps battalion commander informed of progress.

(4) Promptly reports weak points of hostile defense to battalion commander.

(5) Requests supporting fires as needed. Controls fire of attached assault gun and mortar.

b. Maintenance officer.—(1) Conforms to maintenance plan.

(2) Brings command section forward.

c. Communication sergeant.—Liaison duties.

d. Assault platoon leader.—(1) Leads platoon across line of departure at prescribed time and place in proper initial formation.

(2) Leads platoon to objective, utilizing best cover and deflade within his zone.

(3) Observes progress of his platoon, other tank units, and infantry.

(4) By radio, flag signals, prearranged signals, tracer ammunition, and the example of his command tank, directs his platoon against hostile resistance.

(5) Prevents tanks of his platoon from herding and grouping behind small cover.

(6) Reports to company commander when platoon reaches objective.

e. Support platoon leader.—(1) Deploys platoon at time and place prescribed.

(2) Delivers supporting fire as required.

(3) Leads platoon forward at proper time.

INDEX

	Paragraph	Page
Advance guard.....	20	30
Air support.....	29	56
Ammunition:		
Conservation.....	7, 9	7, 11
Types.....	9	11
Smoke.....	27	43
Artillery support.....	29	56
Assembly areas, security.....	18, 25	25, 36
Attachments.....	4	2
Attack. (See Offensive action.)		
Attack position.....	25	36
Bivouac security.....	17	21
Characteristics of tanks.....	5	6
Communication:		
Radio.....	11, 31	13, 60
Sections.....	4	2
Signals.....	11	13
Conservation of ammunition.....	7, 9	7, 11
Control.....	11	13
Defense:		
Delaying action.....	41	76
General.....	38	75
Of a position.....	39	76
Rear guard.....	42	77
Withdrawal.....	40	76
Delaying action.....	41	76
Echelons of attack.....	24	35
Fire and maneuver.....	7	7
Flank guard.....	21	32
Fords, attack of.....	36	75
Fundamentals.....	7	7
Guides.....	25	36
Halts:		
Security at.....	19	25
Time and duration.....	23	35
Infantry, attack with.....	31	60
Jungle warfare:		
Attack.....	44	77
Defense.....	45	77
General.....	43	77

INDEX

	Paragraph	Page
Leapfrogging.....	30	58
Liaison section.....	4	2
Liaison.....	13	18
Maintenance:		
Axis of.....	15	18
Officer.....	4	2
Operation.....	15	18
Section.....	4	2
Use of cover.....	15	18
Marches:		
General.....	22	34
Halts.....	23	35
Security.....	19	25
Mass	7	7
Movement:		
By bounds.....	30	58
Leapfrogging.....	30	58
Offensive action:		
Action in smoke.....	32	63
Air support.....	29	56
Artillery support.....	29	56
Assembly.....	25	36
Attack against armored troops.....	28	51
Attack formations.....	26	41
Attack from march column.....	28	51
Attack in woods.....	35	75
Attack of a ford.....	36	75
Attack of a position.....	29	56
Attack of a river line.....	37	75
Attack position.....	25	36
Attack with infantry.....	31	60
Echelons of attack.....	24	35
General.....	24	35
Meeting engagement.....	12, 28	15, 51
Method of advance.....	30	58
Orders.....	12	15
Position of commander.....	26	41
Operations	6	7
Orders	12	15
Organizations	4	2
Position:		
Attack.....	25	36
Defense of.....	39	76
Of commander, advance guard.....	20	30
Of commander, in attack.....	26	41
Prior training	3	2
Purpose	2	2
Radio:		
Nets.....	11	13
Use of.....	11	13
With infantry.....	31	60
Rallying point, security at	18	25
Rear guard	42	77

INDEX

	Paragraph	Page
Reconnaissance:		
Method.....	14	18
Section.....	4	2
River line, attack of.....	37	77
Scope.....	1	1
Security:		
Air.....	17	21
Advance guard.....	20	30
Assembly area and rallying point.....	18, 20, 25	25, 30, 36
Bivouac.....	17	21
Flank guard.....	21	32
General.....	16	21
Halts.....	19	25
March.....	19	25
Signals.....	11	13
Smoke:		
Action in.....	32	63
Use of.....	27	43
Surprise.....	7	7
Terrain.....	8	8
Training:		
Ammunition.....	9	11
General.....	9	11
Prior.....	3	2
Procedure.....	10	12
Use of sand table.....	10	12
Troop leading.....	Appendix	78
Withdrawal.....	40	76
Woods, attack in.....	35	75



Generated at Library of Congress on 2022-12-15 16:10 GMT / <https://hdl.handle.net/2027/uc1.a0009351198>
Public Domain, Google-digitized / http://www.hathitrust.org/access_use#pd-google

University of California
SOUTHERN REGIONAL LIBRARY FACILITY
405 Hilgard Avenue, Los Angeles, CA 90024-1388
Return this material to the library
from which it was borrowed.

APR 13 1952

UC SOUTHERN REGIONAL LIBRARY FACILITY



A 000 935 119 8

University
Southern
Library